



taranto



LINEA LIVIANA 2018



taranto



LINEA LIVIANA **2015**

En este Catalogo usted puede encontrar todos los artículos para las aplicaciones en las líneas vehicular, pesada y asiáticas.
Para facilitar su búsqueda Taranto le ofrece dos metodologías distintas de búsqueda:
In this Catalog you can find all the articles for the applications in light lines, heavy duty lines and asiatic models.
To facilitar your search Taranto offers two different methodologies:

1 INDICE ORDENADO POR REFERENCIA TARANTO
Index ordered by Taranto references.

► SIMBOLOS - Symbols



Catálogo Vehicular
Automotive Catalog



Catálogo Línea Asiática
Asiatic Catalog



Catálogo Línea Pesada
Heavy Duty Catalog

TABLA DE REFERENCIAS / REFERENCE TABLE

Ref. TARANTO	Pág. CATALOGO			Ref. TARANTO	Pág. CATALOGO			Ref. TARANTO	Pág. CATALOGO			Ref. TARANTO	Pág. CATALOGO		
	VEHICULAR	ASIATICO	PESADO		VEHICULAR	ASIATICO	PESADO		VEHICULAR	ASIATICO	PESADO		VEHICULAR	ASIATICO	PESADO
140000	132			222700	481			241300	38			260400	165		
150000	334			222800	482			241400	39			260500	166		
150100	335			223000	483			241500	40			260600	167		
150200	336			223300	484			241600	41			260700	168		
150300	337			223400	485			241700	42			260800	169		
200000	19			223500	486			241800	43			260900	170		
200200	20			223800	487			241900	44			261100	171		
200300	21			223900	488			242100	45			270000	172		
200400	22			224000	489			242200	46			270100	174		
200500	23			224200	490			242300	47			270200	176		
200600	24			224300	491			242500	48			270300	177		
200800	25			230000	492			242700	49			270400	179		
200900	26			230100	493			242800	50			270500	181		
210000			05	230200	494			242900	51			270600	182		
210100			06	230300	495			243300	52			270700	183		
210200			07	230400	103			243400	53			270900	184		
210300			08	230500	496			243500	54			271100	185		
210400			11	230600	497			244000	55			271200	187		
210500			12	230700	498			244100	56			271300	188		
210600			13	230800	104			244200	57			271500	189		
210700			14	230900	499			244300	58			271800	190		
210800			09	231100	500			250000	137			271900	191		
210900	131			231200	501			250100	138			272000	192		
220000	98			231300	502			250200	139			272100	193		
220100	99			231400	503			250400	140			272200	194		
220300	464			231500	504			250500	142			280000	59		
220400	465			231600	505			250600	144			280100	60		
220500	100			232400	506			250700	146			280200	61		
220600	466			232600	507			250800	147			280300	62		
220700	101			233000	508			250900	148			280400	63		
220800	467			233100	509			251000	149			280500	64		
220900	102			233200	510			251100	150			280600	65		
221000	468			233300	511			251400	151			280700	66		
221100	469			233400	512			251700	152			280800	67		
221400	470			240000	27			252000	153			281100	68		
221500	471			240100	28			252100	154			281200	69		
221695	472			240200	29			252300	155			281300	70		
221700	473			240300	30			252400	156			281400	71		
221800	474			240400	31			252700	157			281500	72		
221900	475			240700	32			252800	158			281600	73		
222000	476			240800	33			252900	159			281700	74		
222100	477			240900	34			260000	161			281800	75		
222200	478			241000	35			260100	162			281900	76		
222500	479			241100	36			260200	163			282000	77		
222600	480			241200	37			260300	164			282100	78		



TABLA DE REFERENCIAS TARANTO - TARANTO REFERENCE TABLE

Ref. TARANTO	Pág. CATALOGO			Ref. TARANTO	Pág. CATALOGO			Ref. TARANTO	Pág. CATALOGO			Ref. TARANTO	Pág. CATALOGO		
	VEHICULAR	ASIATICO	PESADO		VEHICULAR	ASIATICO	PESADO		VEHICULAR	ASIATICO	PESADO		VEHICULAR	ASIATICO	PESADO
282200	79			310600	240			330800			116	401600			132
282300	80			310700	241			331100	321			401700			134
282400	81			310800	242			331200			117	410000	324		136
282500	82			310900	243			331300			118	410100			137
282600	83			311000	244			340100	285			410200			138
290000	84			311100	245			340200	286			410300			139
290100	85			311200	246			340300	287			410400			140
290200	86			320000	247			340400	288			410500			141
290300	87			320100	248			340500	289			410600	325		142
290600	88			320200	249			340600	290			410700			143
290700	89			320300	250			340700	291			410800	326		144
290800	90			320400			111	340800	292			410900			145
290900	91			320500	251			340900	293			420000			146
291000	92			320600	252			350000			83	420100			147
291100	93			320700	253			350100			84	420200			148
300000	203			320800			112	350200			85	420400			149
300100	204			320900	254			350300			86	420600	327		150
300200	205			321000	255			350400			88	422000			151
300300	206			321100	256			350500	301			423000			01
300400	207			321200	257			350600			90	423100			02
300500	208			321300	258			350800			92	423200			03
300600	209			321500	259			350900			93	430000	314		
300700	210	05		321600	260			351000			95	430600	315		
300800	211	06		321800	261			351100	302			430800	316		
300900	212	07		321900	262			351200	303			440000			119
301000	213	08		322000	263			351300	304			440100			120
301100	214	11		322100	264			351500	305			450000	338		
301200	215	12		322200	265			351600	306			450100	340		
301400	216	13		322300	266			351700	307			450200	341		
301500	217	14		322400	267			351800	308			450300	343		
301700	218	09		322500	268			352000			96	450400	345		
301800	219			322600	269			352200			97	450500	347		
301900	220			322700	270			352400	309			450600	349		
302000	221			322800	271			360000			99	450800	350		
302100	222			322900	272			360100	310		100	450900	352		
302200	223			323200	273			360200			101	451295	353		
302300	224			323300	274			360300			102	451395	354		
302400	225			323700	275			360400			103	451500	355		
302500	226			323900	276			360500	311			451600	356		
302700	227			324000	277			360800			105	451700	357		
302800	228			324100	278			370100	312			451800	366		
302900	229			324300	279			400000	322		121	451995	358		
303000	230			324400	280			400100			122	452000	359		
303100	231			324700	281			400200			123	452100	360		
303200	232			324800	282			400300			124	452200	361		
303300	233			324900	283			400400			125	460100	362		
303500	234			330000			65	400500			126	460200	363		
303600	235			330100			66	400600			127	460300	364		
310000	236			330200			67	400700			81	460400	365		
310100	237			330300	284			400800			82	460500	366		
310200	238			330400			113	400900			128	460600	367		
310300	239			330500	319			401000	323		129	460700	368		
310400	317	107		330600	320			401100			130	460800	369		
310500		109		330700			114	401500			131	460900	370		



TABLA DE REFERENCIAS TARANTO - TARANTO REFERENCE TABLE

Ref. TARANTO	Pág. CATALOGO			Ref. TARANTO	Pág. CATALOGO			Ref. TARANTO	Pág. CATALOGO			Ref. TARANTO	Pág. CATALOGO		
	VEHICULAR	ASIATICO	PESADO		VEHICULAR	ASIATICO	PESADO		VEHICULAR	ASIATICO	PESADO		VEHICULAR	ASIATICO	PESADO
461100	371			540000	401			650500			28	861100			
461200	372			540100	402			650600			29	861200			
461500	373			540200	403			650700			30	861300			
470000	374			540300	404			650800			31	861400			
470200	375			540400	405			650900			32	861500			
470300	376			540500	406			651000			33	861600			
470400	377			540900	513			660000			35	862300			
470500	378			550000	407			660100			36	862500			
470600	379			550400	408			660200			37	862700			
470700	380			550500	409			700000			39	862800			
470800	381			550600	410			700100			40	862900			
470900	382			550700	411			700200			41	870000			15
471000	383			550800	412			700300			42	870100			17
471200	384			550900	413			700400			43	870200			19
471300	385			560000	414			700500			44	870500			21
471400	386			560100	415			700600			45	870600			22
471500	387			560200	416			700700			46	880000			159
471700	388			560300	417			700800			47	880100			161
471800	389			560400	418			700900			48	880200			163
471900	390			560500	419			710100			49	880300			165
500000	395			560600	420			710200			50	880400			167
500100	396			560700	421			750000			69	880500			169
500200	391			560800	422			750100			70	880600			171
500300	393			570000	423			750200			71	880700			173
500400	455			570100	424			800000			51	880800			175
500600	394			570200	425			800100			53	890600	453		
510000	105			570300	426			800200			54	900000			
510100	106			570400	427			800300			55	900100			
510200	107			570500	428			800500			57	900200			
510400	108			570600	429			800600			59	900500			
510500	109			570900	430			800800			61	900600			
510700	110			571000	431			800900			62	900700			
510800	111			580000	432			801000			64	900800			
510900	112			580100	433			810000			153	900900			
520100	113			580295	434			810100			154	901300			
520200	114			580495	435			850000			73	901400			
520300	456			580595	436			850100			74	901500			
520400	457			580695	437			850200			75	902100			
520500	115			580700	438			850300			76	902200			
520600	116			580900	439			850400			77	902300			
520800	117			581000	440			850500			78	902500			
520900	118			581200	441			850600			79	902600			
521000	119			581300	442			850700			80	902900			
521100	120			581400	443			860000	451			903400			
521200	121			581700	444			860100	452			903500			
521400	122			581800	445			860200				903600			
521500	123			582100	446			860300				904000			
521600	124			582200	447			860400				910000			
521700	125			582300	448			860500				910100			
521800	126			650000			23	860600				910200			
521900	127			650100			24	860700				910300			
522000	128			650200			25	860800				910400			
522100	129			650300			26	860900				910500			
523000	130			650400			27	861000				910600			



TABLA DE REFERENCIAS TARANTO - TARANTO REFERENCE TABLE

Ref. TARANTO	Pág. CATALOGO			Ref. TARANTO	Pág. CATALOGO			Ref. TARANTO	Pág. CATALOGO			Ref. TARANTO	Pág. CATALOGO		
	VEHICULAR	ASIATICO	PESADO		VEHICULAR	ASIATICO	PESADO		VEHICULAR	ASIATICO	PESADO		VEHICULAR	ASIATICO	PESADO
910700				923500				961000				981200	07		
910900			157	923600				961100				981300	08		
911100				930100				961200				981400	09		
920000				930300				961500				981500	10		
920100				930500				970000				982000	11		
920200				930600				970300				990000			
920400				940000				970400				990300			
920500				940100				970500	295			990400			
920600				950000				970600	296			990500			
920700				950100				970700	297			990600			
921800				950200	02			971100				990700			
921900				950300				971200				990800			
922100				950400				971300				993000			
922200				950500				971400				993100			
922300				950600				971800				993200			
922400				950700				980000	03			993400			
922500				950800				980200	04						
922800				951600				980500	05						
923300				960000				981100	06						

2 | INDICE ORDENADOS POR CM³.
Index ordered by cm³.

MOTORES ORDENADOS POR CM³ - ENGINES ARRANGED BY CM³

ACURA													
Ref.	Modelo/Model		Cm ³	Motor/Engine									
860500	Integra 1986/89		1590cc.	D16A1 (DOHC) 16V 110HP Ø75									
860900	CL VTEC 1997/98		2156cc.	F22B8 150HP Ø80									
AGCO/SISU													
423000	A65/A75, 305/355/365/405/455/465/555/565/600/700, Case-IH CS 68/75	DIESEL	3300cc.	320D/DS Agco Sisu Power 33/69HP Ø108							01		
423100	A950/A990/BM100/BM110 (4x2, 4x4) - MF4292, MF4297	DIESEL	4400cc.	420D/DS Agco Sisu Power 106/129HP Ø108							02		
423200	8000 - Case-IH CS/CVX 120/130/150 - CVX 1135/1145/1155/1170/1190	DIESEL	6600cc.	620D/DS Agco Sisu Power 147/189 Ø108							03		
AGRALE													
330800	Camión TX 1600 1983/...	DIESEL	2942cc.	D229-3 72HP Ø102								116	
330400	7000/7500/8500	DIESEL	4300cc.	4.10 X10 90HP - 4.10T/TCA 133/167HP Ø103								113	
331200	8500/9200	DIESEL	4800cc.	4.12TCE Commom Rail 150/180HP Ø105								117	
ALFA ROMEO													
270600	145/146/155/156 Twin Spark 16V 1996/...		1598cc.	676.01 120HP Ø82									182
271800	145/146 Twin Spark 1996/..., 156 Twin Spark 1997/...		1598cc.	321.02 - 676.01 (DOHC) 16V 120HP Ø82									190
270600	145 Twin Spark 1996/...		1747cc.	671.06 - 671.99 - 322.01 140/144HP Ø82									182
271800	145/146/156 Twin Spark 1997/..., GTV Twin Spark, Spider Twin Spark 1998/00		1747cc.	322.01 (DOHC) 16V 144HP Ø82									190
291000	159 2005/...		1796cc.	939A4 (DOHC) 16V 140HP Ø80,5									92
252100	156 TD 1997/00, 145 TD, 146 TD 1999/...	DIESEL	1910cc.	323.02 105HP Ø82									154
270000	146 TD 1994/99, 155 TD 1993/97	DIESEL	1929cc.	675.01 - 336.01 90HP Ø82.6									172
500400	75TD 1984/92	DIESEL	1995cc.	VM80A 95HP Ø88									455
500400	75 TD 1989/92, 90TD 1984/97	DIESEL	2393cc.	VM81A 110HP Ø92									455
500400	155TD 1993/97, 164TD 1987/92, 1992/98	DIESEL	2499cc.	VM84A - VM08B/07B - VM31B/32B 114/125HP Ø92									455
271007	Alfa 166 1998/00 - 2000/..., Alfa GTV 1996/00 - 2001/..., Alfa Spider 2001/...		2959cc.	161.02/05 - 343.01 218/226HP - 361.01 220HP Ø93									136
271007	Alfa 147, Alfa GTV 2003/...		3179cc.	932A 250HP - 936A6 240HP Ø93									136
ASIA MOTORS													
900700	Towner 1993/...		843cc.	40HP Ø70									
900900	Roesta 1993/...	DIESEL	2184cc.	R2 72HP Ø86									
900800	Topic, Hi Topic 1993/...	DIESEL	2701cc.	75HP Ø96									



AUDI					
Ref.	Modelo/Model		Cm ³	Motor/Engine	
220400	4000, 80, 4E, 100, Fox 1979/83, Coupe 1980/81		1588cc.	YH/YP/YT/YK/YW/YS/YZ/YN/VY/VZ 75/110HP Ø79.5	465
223207	80D/80TD/90TD 1985/91	DIESEL	1588cc.	JK/RA/SB/CY 54/70/80HP Ø76.5	460
230100	80 D/TD 1981/85	DIESEL	1588cc.	CR/JK/CY/JR 54/70HP Ø76.5	493
221400	80 1983/91 - 1987/91 - 1992/93		1595cc.	DT/JU/RN/PP/ABM 71/75HP Ø81	470
224107	A3 2000/...		1595cc.	AVU 100HP Ø81	461
230300	80 1993/95		1595cc.	ADA/ABM 71/100HP Ø81	495
233300	A3 FSI 2003/...		1598cc.	BAG/BLP/BLF (DOHC) 16V 115HP Ø76,5	511
220400	4000 1981/83		1715cc.	WT 79HP Ø79.5	465
221400	80 1986/90, 80 Quattro, 100 1982/91, 100 Quattro 1985/91, Coupe 1986/91		1781cc.	DZ/DS/DR/SH/4B/JW/NP/PH/JV/NE/RU/PM/SF/MU	470
221700	A3 Turbo 1996/..., A3/A3 Quattro 1998/..., A6 1997/...		1781cc.	AJP/AGU/AQA 125/150HP - AJQ/APP 180HP Ø81	473
221800	A4/A4 Turbo 1994/..., A6/A6 Turbo 1995/..., Cabrio 1997/..., A6 Quattro 1999/...		1781cc.	AEB/AJL/ANB 150/180HP AFY/ADR 115/125/HP Ø81	474
232908	TT TFSI - A3 FSI 2007/...		1798cc.	BYT/BZB/CDAA (DOHC) 16V	463
223400	A3 TDI 1996/99	DIESEL	1896cc.	AGR 90/110HP Ø79.5	485
223500	A4 TDI 2000/... - 2004/..., A6 TDI 2001/...	DIESEL	1896cc.	ATJ/AVF/AWX 115/130HP - BKE 116HP Ø79,5	486
230900	A4 D/TDI 1994/96-1997/00, A6 TDI, CabrioTDI 1994/96, 80TDI 1991/94	DIESEL	1896cc.	1Z/AFF/AHH/AFN/AVG/AHU 75/90/110HP Ø79.5	499
222595	80 Quattro, 100 1993/95, 80 1991/95, 100 1993/94		1984cc.	ABK/ABT/AE 90/101/115HP Ø82.5	479
222695	80 Quattro, Coupe 1990/93, 100 1990/93		1984cc.	AAD/ABK/AE 101/115HP Ø82.5	480
232908	TT TFSI 2006/... A3/A4/A5 2008/... Q5/A4 2009/...		1984cc.	CCTA/CDNB/CBFA/CAEA/CFKA 180/200HP Ø82,5	463
233200	A3/A4/A5/Q5 TFSI 2008/... - A4/A5 Quattro 2010/...		1984cc.	CDNB/CDNC/CAEB/CBFA/CAEA 180/211HP Ø82,5	510
222200	80/80 Quattro, Coupe 1983/86, 90/100 1984/88		1994cc.	JS/HP/SK/KP 113/115HP Ø81	478
222200	100/200, Coupe, 90/90 Quattro 1984/91		2226cc.	KZ/KU/HY/KV 115/137/165HP Ø81	478
222795	100, 200 Avant, 100 Avant, Coupe, Cabriolet, 80, 90		2309cc.	NF 100/136HP Ø82.5	481
222895	80/90 1985/94, Cabrio, Coupe 1990/95, A6 1994/..., Coupe Quattro 1985/95 80 Quattro 1991/94, 90 Quattro 1987/91		2309cc.	AAR/NG 133HP Ø82.5	482
223000	80 1991/1994, 80/80 Quattro, Cabriolet, 100/ 100 Quattro 1992/94, A4/A4 Quattro, A6/A6 Quattro 1994/... - Coupe 1991/95		2598cc.	ACZ - ABC V6 144/150HP Ø82.5	483
223000	100/100 Quattro, 80/80 Quattro, Coupe 1990/94, A4/A4 Quattro, A6/A6 Quattro 1994/..., Cabriolet 1991/94		2771cc.	AAH/ABC/AEJ V6 163/174HP Ø82.5	483
232808	A6/A8 FSI 2006/...		2773cc.	BDX/CCDA/CCEA V6 190/209/220HP Ø84.5	463
232808	Q7/Q5 Quattro - A8 Quattro 2010/... - A5 Cabriolet/Coupe 2011/...		2995cc.	CJTC/CJTB/CMDA/CNAA/CTTA/CTWA/CTWB CTUC/CTVA 272/310/333HP V6 (DOHC) 24V Ø84.5	463
232808	A4 - A6 - A8 2005/... - A4 - A6 Quattro 2006/...		3123cc.	BKH/AUK/BPK/BKH/BYU V624V 255HP Ø84.5	463
232508	A3 2005/..., TT 2006/... - TT 2003/06, A3 2004/05		3189cc.	BUB/BHE/BPF/BDB/BMJ 184/250HP VR6 24V Ø84	462
232708	Q7 2006/...		3597cc.	BHK - VR6 V6 (DOHC) 24V 280HP Ø89	462

BEDFORD					
210800	C14 - J17/J27/J37 1962/64	DIESEL	3285cc.	200D 62HP Ø98.3	09
210200	C50 Turbo 1971/79	DIESEL	4927cc.	300DX 97HP Ø98.3	07
210300	J6 1956/61	DIESEL	4927cc.	300D 97HP Ø98.3	08
210000	J6 1961/71	DIESEL	4927cc.	300D 97HP Ø98.3	05
210100	350H, C60, 714 1971/79	DIESEL	5755cc.	350D - CD600 137HP Ø106.36	06

BMW					
981400	1500 1962/86, 1502		1499cc.	M10 B15 70HP Ø84	09
981400	316 (E21) 1975/84, 1600 (E6), 1602, 1600 Ti (E10) 1600 GT		1573cc.	M10 B16 73/84/90/103HP Ø84	09
981300	One Coupe (Mini R50) 2000/01, Cooper Coupe (Mini R50) 2000/01		1598cc.	W10B16A 90/116HP Ø77	08
981100	318TDS 1994/99, 318 Compact TDS 1995/00	DIESEL	1670cc.	M41D (174T1) 90HP Ø80	06
982000	316i, 316ci Coupe, 316ti 2000/...		1796cc.	N42B18A - N40B16A (DOHC) 16V 115/116HP Ø84	11
950200	320, 520 1977/82		1990cc.	M20 122HP Ø80	02
980000	520i 1982/90, 1987/90, 320i 1982/93 - 1988/91		1990cc.	M20 (206KA) 125/129HP - 206EE 130HP Ø80	03
982000	318ti, 318ci Cabrio/Coupe, 320is 2001/..., X3i 2003/..., Z4i 2004/...		1995cc.	N42B20A - N46B20A/B/C - 143/150HP Ø84	11
950200	323i 1977/82		2315cc.	M20 142HP Ø80	02
980000	323i 1982/86		2315cc.	M20 (236EE) 139/150HP Ø80	03
980500	324 D 1985/90, 524 D 1986/87, 324 TD 1987/93, 524 TD 1982/87	DIESEL	2443cc.	M21 (246D/DA) 86HP - M21 (246TB/TA) 115HP Ø80	05
981500	523i 2005/... - 323i, 325i, 325xi, X3i, Z4i 2006/...		2497cc.	N52B25A (DOHC) 24V 177/218HP Ø82	10
980200	325 TD 1991/92, 525 TDS 1990/92	DIESEL	2498cc.	M51 (256T1) 115HP - M51 (256T1-L) 143HP Ø80	04



BMW						
Ref.	Modelo/Model		Cm³	Motor/Engine		
981200	725 TDS 1995/..., 325 TDS, 525 TDS, 325 TD, 525 TD 1994/...	DIESEL	2498cc.	M51 (256T1/256T1-L) 115/143HP Ø80		07
BORGWARD						
					<i>Ver/See VM Borgward</i>	
CATERPILLAR						
960532	Caterpillar Motoniveladora	DIESEL		D339 - D17 - 2 cilindros	XXI	
960534	Caterpillar	DIESEL		D318 - 12 70 D - 6 cilindros	XXI	
960535	Caterpillar	DIESEL		D8 14A - 46A D342 - 3 cilindros	XXI	
960541	Caterpillar	DIESEL		9 44/43 A950 D330 - 4 cilindros	XXI	
960542	Caterpillar	DIESEL		D315 112 34 - 4 cilindros	XXI	
960543	Caterpillar	DIESEL		922 59A D6 - 4 cilindros	XXI	
960544	Caterpillar	DIESEL		12 99E 966 - 334 - 6 cilindros	XXI	
960547	Caterpillar	DIESEL		D9 D353 - 3 cilindros	XXI	
960548	Caterpillar Motoniveladora	DIESEL	6969cc.	3304 Ø120.65 - 4 cilindros	XXI	
960549	Caterpillar Motoniveladora	DIESEL	10453cc.	3306 Ø120.65 - 6 cilindros	XXI	
960550	Caterpillar	DIESEL		3054 - 4 cilindros	XXI	
960551	Caterpillar	DIESEL		3056 - 6 cilindros	XXII	
CHERY						
993000	QQ 2003/...		796cc.	SQR 372 F (DOHC) 12V 70HP Ø72		
993100	QQ3, IQ, Sweet		1097cc.	SQR 472 F (DOHC) 16V 90HP Ø72		
993400	Face 2011/...		1297cc.	473 H (DOHC 16V) 83HP Ø73		
993200	Tiggo 2010/...		1971cc.	Acteco S9R 484 F (DOHC) 16V 125HP Ø83,5		
CHEVROLET - GM - OPEL - VAUXHALL						
282500	Spark 2003/06, Aveo 2006/...		995cc.	B10S 63HP Ø68.5		82
240900	Corsa 1.0 EFI, B10 NZ 1994/...		996cc.	OHC 60HP Ø71		34
241200	Celta 2000/...		999cc.	MPFI (SOHC) 8V 60HP Ø71.1		37
243300	Celta, Classic, Corsa 2003/...		999cc.	MPFI VHC 60HP Ø71.1		52
244200	Prisma, Onix		999cc.	SPE/4 80HP Ø71,1		57
280500	Corsa 1998/...		999cc.	MPFI (DOHC) 16V 68HP Ø71.1		64
240900	Corsa B 1993/97		1196cc.	C12NZ - 12NZ - X12SZ 45HP Ø72		34
241195	Corsa A 1990/93, Kadett E 1986/91 - Nova 1985/...		1196cc.	12NV - 12ST 54/55HP Ø77.8		36
241395	Kadett D, Kadett E 1979/86 - Cavalier, Astra 1980/85		1297cc.	13N/SB - 13NS/SC - 13N/S 60/70/75HP Ø75		38
240400	Corsa EFI		1389cc.	C14 NV/NZ 60/75HP Ø76.5		31
241000	Celta MPFI 2004/...		1389cc.	C14E Familia I 85HP Ø77.6		35
244000	Corsa Econoflex, Classic, Agile, Celta 2006/2009 - 2009/...		1389cc.	X14SE/Y14NE - MPFI (SOHC) 8V 90/92HP Ø77,6		55
244300	Prisma, Onix		1389cc.	SPE/4 106HP Ø77,6		58
282300	Corsa 2002/04		1389cc.	ZX14E 90HP Ø73.4		80
200800	Chevette 1973/89		1393cc.	GMC 85 45HP Ø82		25
291000	Aveo 2009/...		1399cc.	F14D4 (DOHC) 16V 101HP Ø80.5		92
242607	Corsa A, Corsa A TD 1987/92, Kadett E TD 1984/91, Nova 1991/96	DIESEL	1488cc.	15D (4EC1) - 15TD (4TEC1) 50/67/72HP Ø76		15
240300	Monza, Kadett 1981/86		1598cc.	CN16 - 16SH 90HP Ø80.3		30
240400	Corsa 1.6 MPFI, Ascona C 1986/88, Astra, Vectra A 1991/97, Corsa A GSI, Nova 1987/93, Kadett E 1986/91, Cavalier 1988/94		1598cc.	C16LZ/NZ/SV - E16ASE 75/82HP - X16SZ 71HP 16NZ/SV 75/82HP Ø79		31
242300	GM Corsa, Vectra, Kadett 1999/...		1598cc.	C1.6 SE - X16 SZR 8V 100/75HP Ø79		47
242407	Kadett, Ascona C, Kadett E, Ascona C, Belmont, Cavalier 1982/89	DIESEL	1598cc.	16D 54HP - 16DA 60HP Ø80		15
280600	Corsa, Opel, Tigra, Astra, Vectra 1993/...		1598cc.	C16XE - C16XEL (DOHC) 16V 109HP Ø79		65
290100	Nubira 2003/05, Aveo MPI (103HP) 2004/...		1598cc.	F16 D3 (DOHC) 16V 103/109HP Ø79		85
200800	Chevette 1973/89		1599cc.	GMC 98 71HP Ø82		25
242500	Corsa, Astra G DTI, Corsa C DI, Combo Tour TD 2000/...	DIESEL	1686cc.	Y17 DIT/DTL (DOHC) 16V Iny. Directa 65/75HP Ø79		48
280200	Corsa D, Combo D 1997/..., Vectra TD 1991/96, Astra TD 1994/97	DIESEL	1686cc.	4EE1 - 4EE1T 60/82HP Ø79		61
241600	Astra 1991/94, Vectra A 1989/95, Astra Max 1990/..., Belmont 1989/91	DIESEL	1700cc.	17D/DR 57/60HP Ø82.5		41
241700	Astra TD, Astra F TD 1994/97	DIESEL	1700cc.	17DTL 68HP Ø82.5		42
243500	Astra TD 1994/97, Astra GTD 1998/00 - Motor 14555260 08/1994	DIESEL	1700cc.	X17 DTL 8V 68HP Ø82.5		54
241800	Corsa II, Meriva 2003/...		1781cc.	L79 (DOHC) 16V 122HP 80.5		43
200200	Opel K180 1974/79		1790cc.	K180 Ø90.49		20
240000	Monza 1.8 SLE/SEE, Kadett, Rekord 1983/...		1796cc.	C18N S/E 75/90HP Ø84.8		27



CHEVROLET - GM - OPEL - VAUXHALL

Ref.	Modelo/Model	Cm ³	Motor/Engine		
240200	Monza 1996/..., Astra 1991/..., Kadett , Ascona 1986/91, Vectra 1988/95, Blazer	1796cc.	C18NE FII 90HP Ø84.8		29
242200	Corsa, Meriva 2003	1796cc.	GM Powertrain 102HP Ø80.5		46
244100	Spin, Cobalt	1796cc.	N18XFN 108HP Ø80,5		56
280000	Monza, Kadett 1986/91, Astra 1991/97, Vectra 1989/95	1796cc.	C18NE/NV - C18NZ 90HP Ø84.5		59
281600	Astra 2000/03	1796cc.	Z18XE 120HP Ø80.5		73
291000	Cruze 2008/...	1796cc.	F18D4 (DOHC) 16V 141HP Ø80.5		92
291000	Astra H 2004/..., Signum, Vectra C, Zafira B 2005/..., Insignia 2008/...	1796cc.	Z18XER - A18XER (DOHC) 16V 141HP Ø80.5		92
291100	Epica, Optra, Lacetti, Nubira, Captiva, Tosca 2006/... - Cruze 2009/...	DIESEL 1991cc.	Z20S 150HP - Z20DM 121HP - Z20DMH 150HP Ø83		93
290700	Astra, Vectra, Omega, Zafira, Opel	DIESEL 1995cc.	X20 DTL-DTH 16V 82/100HP Ø84		89
582300	Vivaro CDTI 2006/08 - 2008/...	DIESEL 1995cc.	M9R 780/782/784/786/788 90/114HP Ø84		448
240200	Kadett 1986/91, Ascona 1986/88, Vectra 1988/95	1998cc.	C20NE 115/130HP Ø86		29
241500	Omega MPFI, Vectra MPFI 1992/98	1998cc.	OHC 110/115/130HP Ø86		40
241500	Frontera 1991/95, Calibra, Cavalier, Kadett, Omega A 1986/94, Astra 1991/96	1998cc.	C20NE/SEH/SER/NEF 100/115/130HP Ø86		40
280700	Astra 1995/..., Omega B, Calibra 1994/...	1998cc.	X20XE (DOHC) 16V 136HP Ø86		66
281900	Astra 1995/98, Optra, Zafira 1998/...	1998cc.	X20 XEV (DOHC) 16V 128/136HP Ø86		76
290800	Vectra, Astra, Calibra, Zafira 1994/..., Astra 1998/...	1998cc.	X20 XEV (DOHC) 16V 128/136HP Ø86		90
290900	Vectra - Turbo 1994/96, Calibra - Turbo1989/97, Kadett E 1987/91	1998cc.	C20XE 136/150HP - C20LET 16V 204HP Ø86		91
241400	Vectra 1997/...	2000cc.	MPFI (SOHC) 8V 116HP Ø86		39
290700	Vectra, Zafira, Omega, Frontera, Sintra	DIESEL 2171cc.	X22 DTH 16V115/116HP Ø84		89
281800	Cavalier 1998/03	2190cc.	LN2 120HP Ø89		75
290200	Lumina, Cavalier 1987/97	2190cc.	LN2 120HP Ø89		86
290300	Lumina, Cavalier 1994/97	2190cc.	LM3 120HP Ø89		87
282100	Cavalier, Malibu, HHR, Astra, Zafira, Vectra, Pontiac Sunfire, Grand Am 2000/03	2198cc.	Z22SE - L61 147HP Ø86 (DOHC) 16V		78
290800	Vectra 1998/..., Sintra 1996/99	2198cc.	X22 XE (DOHC) 16V 139/141HP Ø86		90
241400	Vectra 1997/...	2200cc.	MPFI (SOHC) 8V 123HP Ø86		39
290407	Cavalier 1994/02	2200cc.	C134		18
280400	Luv, Pick Up 1986/92	DIESEL 2254cc.	4ZD1 88HP Ø89.3		63
290000	Captiva 2008/...	2384cc.	LE5 16V 174HP Ø88		84
282400	Pontiac Sunfire, Grand Am, Malibu, Cavalier Z24, 1996/04 - Alero 1999/...	2393cc.	LD9 141/152HP Ø90		81
243400	Astra 2004/..., S10 2005/..., Vectra 2006/...	2405cc.	Powertrain 147HP Ø87.5		53
240100	Opala 153 1969/73, Opala A10 80/84/610 1976/...	2475cc.	GM 153 Ø101.6		28
240800	Opala, C10, A10 1974/..., Comodoro, Caravan, A10 1980/84	2475cc.	GM 151 90HP Ø101.6		33
981200	Omega B TD 1994/96	DIESEL 2498cc.	U25TD/X25TD 130HP Ø80		07
240700	Pick Up Luv	DIESEL 2499cc.	4JA1 76HP Ø93		32
520300	Frontera A TD 1995/98	DIESEL 2499cc.	VM41B 115HP Ø92		456
242900	Pontiac Vin E 1988/92	2500cc.	L4 - 151		51
430000	Blazer TDI, S10TDI 1995/...	DIESEL 2507cc.	95HP Ø90.7		314
330500	SD TD, Blazer TD 2000/...	DIESEL 2796cc.	Sprinter 4.07 CA 125HP Ø93		319
331100	Blazer, S10 2000/...	DIESEL 2796cc.	Sprinter 4,07 TCA Common Rail 132HP Ø93		321
241900	Cutlass, Century, Eurosport, Cavalier 1989/94	2800cc.	172 V6 2da. Generación / Cabeza de Aluminio		44
242800	Citation, Celebrity, Century 1982/86	2800cc.	172 V6 Carburados		50
241900	Cutlass, Century, Eurosport, Cavalier 1989/94	3100cc.	172 V6 2da. Generación / Cabeza de Aluminio		44
281700	Malibu 2000/03	3100cc.	V6 LG8 170HP Ø89		74
282200	Malibu 1997/99	3136cc.	LG8 V6 170HP Ø89		79
200000	400 1964/72	3185cc.	194 Ø90.48		19
282000	Venture, Impala, Monte Carlo, Alero, Gran Am, Silhouette, Trans Port 2000/03	3350cc.	LA1 V6 3400 170HP Ø92		77
282600	Venture 1997/99	3350cc.	LA1 185HP Ø92		83
200900	Chevrolet 3 ½ - Chevrolet 3 9/16 1939/53	3540cc.	216 - 224 - 235 Ø88.9		26
200900	Chevrolet 3 ½ - Chevrolet 3 9/16 1939/53	3674cc.	216 - 224 - 235 Ø90.5		26
200000	Super 1964/69, RS Malibu	3769cc.	230 Ø98.43		19
200400	Apache C10 3.9/16, Camión 4400 1957/..., Bel Air, Impala 1953/62	3851cc.	235 130HP Ø90.48		22
401000	Vehicular GM D20	DIESEL 3860cc.	Q20B4 Iny. Directa 70HP Ø98.4	129	323
410600	GM D10/20/40 Aspirado Turbo	DIESEL 3860cc.	Q20B4.236 Iny. Directa 70HP Ø98.4	142	325
280300	D20/D40, Pick Up D20	DIESEL 3990cc.	Maxion S4 102HP Ø100		62



CHEVROLET - GM - OPEL - VAUXHALL				
Ref.	Modelo/Model	Cm³	Motor/Engine	
200000	Pick Up Chevy 1969/79	4047cc.	250 Ø98.43	19
200300	Pick Up C10 1989/...	4097cc.	250 Ø98.47	21
200500	Silverado, Pick Up 7B 1980/..., Cheyenne 1979/81	4097cc.	250 Ø98.43	23
281300	Trail Blazer 2002/06	4160cc.	Atlas LL8 - L6 (DOHC) 24V 275HP Ø94	70
330600	GM Silverado 3500HD 1997/..., Grand Blazer 1998/...	DIESEL 4200cc.	Sprinter 6.07 TD 167HP Turbo Intercooler 198HP Ø93	320
200600	Camión 3 3/4 6500 1954/62, C10, C 14, C60 BR 1969/...	4277cc.	261 142HP Ø95.25	24
290600	Capriche, Impala, Regal, Blazer MPFI 1996/98	4294cc.	262 V6 180/193HP Ø101.6	88
242100	Pick Up 1988/93	4300cc.	262 V6	45
242700	Pick Up 1986/92	4300cc.	262 TK V6 Ø101.6	49
281400	Vortec, Silverado, Sierra, Suburban, Tahoe Yukon 2001/03	4800cc.	LY2 295HP Ø96	71
281400	Vortec, Silverado, Sierra, Suburban, Tahoe Yukon 2001/03	5300cc.	L59 295HP Ø96	71
280100	283/302/307/327 Carburador, 327, 350 No Corvette, 350, Pick Up y Medianos, 283/307/327 Camiones 1967/...	5735cc.	GM C350 V8 Ø101.6	60
280800	350 1986/93 No Corvette, Pick Up, Camiones 350 1986/95	5735cc.	C350L V8 Ø101.6	67
281100	Truck 1996/01, Vortec Vin R	5735cc.	C350 V8 Ø101.6	68
410900	Brasil D60 - D70	5840cc.	6-357 Veh. 120HP - Ag. 91HP - Ind. 108HP Ø104.14	145
281500	Vortec, Silverado, Sierra, Tahoe Yukon, Express, Pick Up 2500/3500 2001/03	6000cc.	LQ4 325HP Ø101.6	72
281200	Silverado, GMC Sierra 2500/3500HD, Suburban GMC Yukon XL, Avalanche 2500 Kodiak 2001/04 - Camión	8123cc.	L18 V8 550HP Ø108	69
CHRYSLER - DODGE - JEEP				
220100	D1500 - Paikan, GT90/GT100 1971/...	1498cc.	Hillman 72HP Ø86	99
230400	Neón 1997/99	1796cc.	122 CID (SOHC) 16V 116HP Ø83	103
220100	D1800 - Paikan, GT90/GT100 1971/...	1798cc.	Hillman 110HP Ø86	99
961500	Vista - Colt 1992/94	1834cc.	4G93 (SOHC) 16V 120HP Ø81	
550600	Wrangler 1983/86	1995cc.	J5R Ø88	410
230400	Neón, Cirrus, Stratus, Voyager 1996/01	1996cc.	ECB/420H (SOHC) 16V 132HP Ø87.5	103
230800	Neón, Sebring, Avenger 1995/...	1996cc.	4A20 (DOHC) 16V 130/140HP Ø87.5	104
521000	Neon 2000/05	1996cc.	(SOHC) 16V 135HP Ø87,5	119
521100	PT Crusier 2002/05	1996cc.	ECC 150HP Ø87,5	120
560000	Jeep Wagoneer TD 1984/95, Comanche TD 1986/88	DIESEL 2068cc.	852/J8S 65/86HP Ø86	414
520200	Lebaron, Spirit, Shadow, Voyager, Phantom, Caravan, Daytona 1982/98	2213cc.	135 (EDR) 177HP Ø87.5	114
521200	Lebaron, Daytona Turbo 1989/...	2213cc.	135 (EDR) 177HP Ø87.5	121
910500	Pick Up Power Ram 50 TD 1983/85	DIESEL 2346cc.	4D55T 67HP Ø91	
523000	Avenger, Patriot, Caliber, Sebring, Stratus 2007/...Journey, Compass 2009/...	2360cc.	ED3 - GEMA (DOHC) 16V 170/174HP Ø88	130
521400	Stratus, Cirrus, Caravan, Grand Caravan, Voyager, Grand Voyager 1995/00	2429cc.	EDZ 150HP Ø87.5	122
521500	Stratus 2002/6	2429cc.	EDZ 150HP Ø87.5	123
522100	PT Cruiser 2002/05	2429cc.	EDZ 150HP Ø87.5	129
510400	Dakota, Pick Up, Jeep Cherokee, Comanche, Wrangler, Renegade 1991/96	2464cc.	D150 121HP Ø98.4	108
520600	Stratus, Avenger, Sebring, Cirrus 1995/99	2497cc.	150 (H00) (SOHC) V6 24V 167HP Ø83.5	116
500400	Voyager TD, Grand Voyager TD 1992/94	DIESEL 2499cc.	HR425CLI(M00) 118HP Ø92	455
520300	Dakota, Grand Voyager, Cherokee, Grand Cherokee TD 1995/...	DIESEL 2499cc.	VM425TD 114/115/116HP Ø92	456
520200	Caravan, Grand Caravan, Grand Voyager, Saratoga 1986/95 EDT Voyager, Caravan, Lebaron, Daytona 1989/92	2501cc.	EDM (K00) 99/101HP - EDT 150HP Ø87.5	114
521200	Voyager, Caravan, Saratoga, Lebaron, Daytona Turbo 1989/...	2501cc.	153 (EDT) 150HP Ø87.5	121
520800	Pick Up, Lebaron, Caravan 1981/89	2555cc.	G54B	117
352400	Grand Cherokee TD 2002/...	DIESEL 2685cc.	ENF (DOHC) 20V 163HP Ø88	309
220000	Valiant I/II/III/IV D100, D2800, Polara, Coronado, RT 1964/79	2788cc.	170 130HP Ø86,36	98
520900	Pick Up 1987/96, Caravan	3000cc.	181 V6	118
520400	Jeep Cherokee, Grand Cherokee, Dakota, Caravan 2001/...	DIESEL 3100cc.	VM531TD 142HP Ø92	457
510000	Caravan, Voyager, Grand Voyager, New Yorker, Town & Country 1990/99	3301cc.	201 (R00) V6 152/162HP Ø93	105
400000	D100/D200 1987/...	DIESEL 3336cc.	4.203-P4-192Z 71HP Ø91.49	121 322
522000	Concorde, New Yorker LHS	3518cc.	EGE 214HP Ø96	128
220000	Valiant I/II/III/IV D100, Polara, Coronado, RT 1964/79	3687cc.	225 130HP Ø86,36	98
521800	Dakota, Ram 1500, Durango 2000/09, Liberty, Grand Cherokee 2002/09	3701cc.	EKG V6 (SOHC) 12V 210HP Ø93	126



CHRYSLER - DODGE - JEEP

Ref.	Modelo/Model	Cm ³	Motor/Engine		
510100	Caravan, Voyager, Grand Voyager, New Yorker, Town & Country 1991/99	3778cc.	231 (L00) V6 162/166HP Ø96		106
521600	Voyager 2002/06 - Pacifica 2004/07	3778cc.	EGH 162HP Ø96		124
510500	Dakota Pick Up 1996/...	3900cc.	V6 130HP Ø99.3		109
520100	Pick Up V6 1987/91	3910cc.	239 CID V6 130HP Ø99.31		113
220700	Continental 3 3/8 - 3 7/16, D100/200/400/500 1951/64	3956cc.	241 95HP Ø85.73		101
220900	Grand Cherokee Laredo, Cherokee, Sport, Comanche, Wrangler 1986/91	3960cc.	240 - 242/L 185HP Ø98.4		102
220700	Continental 3 3/8 - 3 7/16, D100/200/400/500 1951/64	4106cc.	251 100HP Ø87.31		101
510800	Grand Wagoneer, Pick Up 1981/88, Scrambler 1981/86, Jeep CJ/DJ 1981/86	4200cc.	258 AMC Jeep 170HP Ø95.25		111
510900	Wrangler, Jeep YJ 1986/90	4200cc.	258 AMC Jeep 170HP Ø95.25		112
521700	Dakota, Ram 1500 2000/11, Grand Cherokee, Aspen, Commander 2006/09	4698cc.	V8 Magnum 235HP Ø93		125
400100	DP 400/500 1964/... DIESEL	5004cc.	6.305 Cadenero 100HP Ø91.44	122	
440100	Camión 1978/... DIESEL	5100cc.	D225-6 102HP Ø95	120	
220500	GTX, Coupe 1970/...	5210cc.	318 V8 202HP Ø99.31		100
510200	Barracuda, Super Bee 1970/74	5210cc.	318 LA V8 202HP Ø99.3		107
510700	Grand Cherokee 1993/...	5210cc.	318 V8 215/223HP Ø99.3		110
521900	Ram 2500/3500, Ram Quad, Charger, Jeep Comander, Sonora, 300C, Aspen	5645cc.	V8 Hemi 345HP Ø99.5		127
400200	DP 600/800 1968/... DIESEL	5798cc.	6.354-2 140HP Ø98.47	123	
400400	D600/800 1976/... DIESEL	5798cc.	6.354-4 Turbo 172HP Ø98.42	125	
400900	DP 600/800 DIESEL	5798cc.	6.354-1 135HP Ø98.43	128	
410900	P700D/ P900 DIESEL	5840cc.	6-357 Veh. 120HP - Ag. 91HP - Ind. 108HP Ø104.14	145	
870100	Truck 359 1989/93, Ram 2007/...	5883cc.	6B 330HP Ø102	17	
520500	Charger, Dart GTS, Cordoba, Monaco, Super Bee, D350/D600 1979/92	5899cc.	360 Con Carburador y T.B.I		115

CIMARRON

210500	1986/... DIESEL	3283cc.	3300D 89HP Ø98.42	12	
210400	1976/85 DIESEL	3285cc.	3300D 88HP Ø98.3	11	
210600	1979/85	3840cc.	3800D 99HP Ø106.4	13	
210700	1986/...	3840cc.	3800D 99HP Ø106.4	14	

CITROËN

150000	2CV, AZ, AZAM, AZN, AZU, AZUB 1966/68	425cc.	A 79/0 24HP Ø66		334
150100	2CV, AZL 1968/69	425cc.	A 79/1 28HP Ø66		335
150200	3CV 1969/78	602cc.	M28/0 - M28/1 35HP Ø74		336
150300	Ami 8, Mehari, Dyane, 3CV	602cc.	M28/0 - M28/1 33HP Ø74		337
460500	C15 1985/..., Visa 10 1986/88	954cc.	108C Ø70		366
451500	C15 1988/..., AX 10 1986/..., Saxo 1996/...	954cc.	TU9 - TU9M 41/45/50HP Ø70		355
451800	Visa 11 1978/85, C15 1984/85	1124cc.	109/5 - 109/K 57HP Ø72		366
451500	Saxo, Berlingo, ZX 1996/...	1124cc.	TU1M 60HP Ø72		355
451700	AX11 1986/97 - BX 11 - C15 1988/... - ZX 1991/98	1124cc.	TU1/M/MZ (Motor con block de aluminio) 55HP Ø72		357
460500	Visa 11, C15 1985/...	1124cc.	109/5 - 109/K 57HP Ø72		366
460700	AX 11, BX 11, C15 1986/..., ZX 1991/95	1124cc.	TU1/M/MZ 55HP Ø72		368
451800	Visa Super X 1981/83	1219cc.	129/5 64HP Ø75		366
460700	AX Sport 1987/91	1294cc.	TU24/M4A 94HP Ø75		368
451600	AX14, BX14 1991/..., ZX 1994/..., AX GT 1993/..., C15 1991/...	1360cc.	TU3F-TU3FM- TU3F2C 75/80HP Ø75		356
451700	BX 14, C15 1988/..., Saxo, Xsara, Berlingo 1996/..., AX 14, AX GT 1986/...	1360cc.	TU3M/S/A/MC/JP 70/75/80/85HP Ø75		357
451800	Visa GT, BX 14 1982/85	1360cc.	150 70/72HP Ø75		366
452200	C2/C3, C3 Pluriel 2002/..., Berlingo 1997/...	1360cc.	TU3JP (KFW) - TU3-2 (K5A) 75HP Ø75		361
460500	Visa GT, Bx14 1985/...	1360cc.	150 70/72HP Ø75		366
460700	BX 14, C15 1988/..., Saxo, Berlingo, Xsara 1996/..., AX 14, AX GT 1986/...	1360cc.	TU3MC/JP/A 70/75/80/85HP Ø75		368
470400	AX 14 1988/94 DIESEL	1360cc.	TUD3(K9A) 52HP Ø75		377
471700	C3 Picasso, C3 2009/..., DS3 2010/...	1397cc.	EP3 (8FS/8FP) - EP3C (8F01) 95HP Ø77		388
302100	C3/C2 HDI, Xsara HDI 2002/... DIESEL	1398cc.	DV4TD (8HZ/8HX) 70HP (SOHC) Ø74		222
470300	AX 15 1994/97, Saxo 1996/... DIESEL	1527cc.	TUD5 (VJY) 55/58HP Ø77		376
471300	Xsara, Picasso TD 1999/..., C4/C5 TD 2004/... DIESEL	1560cc.	DV6TED4(9HY/Z) (DOHC) 16V 104HP Ø75		385
451295	BX16 1985/90, BX 16 GTI 1991/93, Visa GTI 1985/...	1580cc.	XU5CP 75/105HP - XU5J 75HP - XU5JA 115HP Ø83		353
452100	Berlingo, C3 Pluriel, Xsara 2000/..., C2, C3 2002/... - 2004/...	1587cc.	TU5JP4 (NFU/N6A) 16V 109HP Ø78.5		360



CITROËN					
Ref.	Modelo/Model	Cm³	Motor/Engine		
470500	ZX, Saxo 1996/..., Xsara 1997/...	1587cc.	TU5JP 90HP Ø78.5		378
471700	C4/C4 Coupe, C4/C3 Picasso 2008/..., Berlingo, C3 2009/..., DS3 2010/...	1598cc.	EP6 (5FW/5FS) - EP6C (5F01) 120HP Ø77		388
471800	C4, C4 Grand Picasso, C4 Picasso 2008/..., C5, C5 Tourer 2009/..., DS3 2010/...	1598cc.	EP6DT (5FX/5FR) - EP6CDT (5F04) 150/156HP Ø77		389
460100	Xantia 1997/01, Xsara 1997/...	1761cc.	XU7JP-XU7JB 90/103HP Ø83		362
460800	Xsara 1997/..., Xantia 1995/96, Xantia 1997/2001, ZX 1997/98	1761cc.	XU7JP4 (DOHC) 16V 112HP Ø83		369
461100	Berlingo 1997/...	1761cc.	XU7JB 90HP Ø83		371
470700	BX 17 TD 1988/92	DIESEL 1769cc.	XUD7TE 90HP Ø80		380
470900	C15 1994/..., Berlingo 1996/99, Xsara 1997/..., ZX 1991/94	DIESEL 1769cc.	XUD7 (161A/A9A) 60HP Ø80		382
470600	Berlingo, Jumpy, Xsara 1998/..., C5, Xsara, Jumpy 2000/...	DIESEL 1868cc.	DW8 (WJZ/WJY) 71HP Ø82.2		379
451295	BX19, BX 19 GTI 1984/93	1905cc.	XU92S 96HP XU9J1 104HP Ø83		353
451407	BX GTI 1987/93	1905cc.	XU9J4 160HP Ø83		329
460200	BX19 1984/93, BX19 GTI 1983/93	1905cc.	XU92C 96/104/125HP Ø83		363
460300	Xantia, Berlingo, Dispatch, Relay, Jumper, Jumpy 93/99, Xsara 1997/...	DIESEL 1905cc.	XUD9 69HP Ø83		364
460900	Xantia TD, ZX TD, Dispatch TD, Jumper TD, Jumpy TD 1993/...	DIESEL 1905cc.	XUD9TE/TF (DHX) 90/92HP Ø83		370
461307	Dispatch, Relay, Jumpy, Xsara 1995/99, Berlingo, ZX 1994/98, Jumper	DIESEL 1905cc.	XUD9/XUD9A (D9B/DJY/HV/JZ) 69/71HP Ø83		331
470800	Xantia HDI, Jumper HDI, Xsara HDI, Berlingo HDI, Evasion HDI, Dispatch HDI, Xsara Picasso HDI 1998/..., Jumpy HDI, Xsara HDI, C5 HDI 2000/...	DIESEL 1997cc.	DW10TD/ATED 90/110HP Ø85 DW10TD(RHV/RHY/RHX/RHZ) - 90/94/110HP Ø85		381
471200	Jumpy, Dispatch, Xsara, Evasion 1998/..., C5/C5 HPI 2001/..., C8 2002/..., C4 2004/..., Xsara Picasso	1997cc.	EW10J4(RFN-RLZ) 16V 136/147HP Ø85		384
471400	C4/C5 HDI 2004/..., C4 Picasso HDI, C8 HDI, C4 HDI FAP 2006/...	DIESEL 1997cc.	DW10BTED4 (RHR) 136HP Ø85 (DOHC) 16V		386
471500	Evasion HDI 2000/..., C8 HDI, Jumpy HDI 2002/...	DIESEL 1997cc.	DW10ATED4 (RHW/RHM/RHT) 109HP Ø85		387
471900	C5/C5 HDI, C5 Tourer HDI 2009/..., C4 Grand Picasso 2010/...	DIESEL 1997cc.	DW10CTED4 (RH02/RHH) (DOHC) 16V 163HP Ø85		390
451395	XM 1989/94 - 1990/93	1998cc.	XU10M 107HP - XU102C/J2 115/122/130HP Ø86		354
451995	ZX 1992/96, Xantia 1993/98	1998cc.	XU10J2C 123HP Ø86		358
460600	ZX 1992/..., Xantia 1993/98	1998cc.	XU10J2C 123HP Ø86		367
470200	ZX 1992/97, Xantia 1993/95	1998cc.	XU10J4 16V 155 Ø86		375
471000	Xantia 1995/01, Xsara 1998/00, Evasion, Synergie 1998/...	1998cc.	XU10J4R (RFV) 16V 132/135HP Ø86		383
461500	XM TD 1989/00, Xantia TD 1995/98, Dispatch TD, Evasion TD, Jumper TD, Jumpy TD, Synergie 1996/99	DIESEL 2088cc.	XUD11ATE(P8A) - XUD11BTE(PHZ/P8C) 12V 110HP Ø85		373
471500	C5 HDI 2001/..., C8 HDI 2002/...	DIESEL 2179cc.	DW12TED4 (4HX/4HW) 130/133HP Ø85		387
324800	Jumper HDI 2006/...	DIESEL 2198cc.	4HU/4HV (P22DTE) 101/120HP Ø86		282
452000	Jumper TDI, Relay TDI 1997/...	DIESEL 2445cc.	DJ5TED(THX) 107HP Ø92		359
470000	Jumper D/TD, XM TD, Relay D/TD 1994/97	DIESEL 2445cc.	DJ5/T (T9A-T8A/THZ) - DK5ATE 86/103/130HP Ø92		374
471108	Jumper TDI - Relay TDI 1996/00	DIESEL 2445cc.	DJ5TED (THX) 107HP Ø92		332
CUMMINS					
870000	Serie B	DIESEL 3900cc.	4B - 4BT - 4BTA 100/130HP Ø102		15
870500	Bus, Agrale, Euro III/IV, Electrónico 2003/...	DIESEL 3920cc.	ISBe 150/170HP Ø102		21
800800	ISB 2004/...	DIESEL 5883cc.	ISBe 6 275HP Ø102		61
870100	Serie B	DIESEL 5900cc.	6B - 6BT - 6BTA 180/205HP Ø102		17
870600	17220 17300 17310 18310 2003/... - Cargo 2003/...	DIESEL 8270cc.	ISCe6 24V 315HP Ø114		22
870200	Serie C - Bus, Camión, Agrícola	DIESEL 8300cc.	6C - 6CT - CTA 254/294HP Ø114		19
870307	Serie C - Bus	DIESEL 8300cc.	6C - 6CT - CTA 254/294HP Ø114		XXIII
DACIA					
560200	TXL 1310/1410	1397cc.	TXL 60HP Ø76		416
571000	Sandero 2008/..., Logan 2004/...	1598cc.	K7M 710/718/810/814 90HP Ø79.5		431
DAEWOO					
940000	Matiz 1998/..., Tico 1996/..., Damas 1981/..., Spark 2003/06	796cc.	F8CV 52HP Ø68.5		
282500	Matiz 2003/06	995cc.	B10S 63HP Ø68.5		82
282500	Kalos 2002/...	1148cc.	F12S3 71/72HP Ø68.5		82
290100	Kalos 2004/...	1399cc.	F14 D5 (DOHC) 16V 94HP Ø77.9		85
240400	Cielo, Espero 1994/97	1498cc.	G15MF 78/75HP Ø76.5		31
240400	Lemans, Racer 1989/...	1598cc.	OHC 75HP Ø79		31
290100	Nubira 2003/05 - Lacetti 2004/...	1598cc.	F16 D3 (DOHC) 16V 109HP Ø79		85
940100	Aranos, Espero, Prince 1993/97, Leganza 1997/...	1796cc.	C18LE 95HP Ø86		



DAEWOO

Ref.	Modelo/Model		Cm ³	Motor/Engine		
291100	Epica 2006/... - Captiva - Toscana 2007/...	DIESEL	1991cc.	Z20S 150HP (SOHC) 16V Ø83		93
940100	Espero, Prince, Lemans 1991/..., Leganza 1997/..., Magnus 2001/..., Espero,		1998cc.	C20LE/C20NE 97/105/110/116HP Ø86		
241500	Lemans, Racer 1989/97, Aranos 1995/..., Nubira II 1999/...		1998cc.	C20LE - C20NE 97/110/116 Ø86		40
280700	Leganza 1997/..., Nubira 1997/..., Nubira II 1999/..., Magnus 2001/...		1998cc.	X20SED (DOHC) 16V 134/136/148HP Ø86		66
280700	Leganza 1998/...		2198cc.	X20SED (DOHC) 140HP Ø86		66

DAIHATSU

950000	55 Wide Cab, Max Cuore, Cab Van, L40, S10/S60 1977/...		547cc.	AB - 20/30 Ø71.76		
950100	G10/G20 Charade 1981/...		993cc.	CB - CB 12/37 40HP Ø76		
970000	Charmant 1978/80		1588cc.	2T 74HP Ø85		
970000	Delta Wide 1978/80		1770cc.	13T 95HP Ø85		
900200	Delta Wide 1982/...	DIESEL	1839cc.	1C 84HP Ø83		
920500	Delta Wide 1983/88	DIESEL	1839cc.	1C 68HP Ø83		
920400	Delta Wide D/TD 1985/91	DIESEL	1975cc.	2C/2CT 73/91HP Ø86		
923500	Rocky 1993/01		2237cc.	4Y Ø91		
900405	Delta 1980/88	DIESEL	2977cc.	B 85HP Ø95		

DEUTZ

650000	A40, Tractor	DIESEL	2660cc.	F2L 514 56HP Ø110		23
650200	69/75 A 46, Tractor 74/78 A65 1969/75	DIESEL	2908cc.	A - F2L 1114 Ø115		25
660000	913 1978/81	DIESEL	3064cc.	B-F3L 913 Ø102		35
650200	69/75 A 46, Tractor 74/78 A65 1969/75	DIESEL	3167cc.	A - F2L 2114 Ø120		25
650300	514, Tractor A55 1959/69	DIESEL	3990cc.	F3L 514 50HP Ø110		26
660100	913, Agrale 4-913, Turbo 4-913 1978/...	DIESEL	4086cc.	F4L 913 87HP Ø102		36
650600	1114 - Tractor A65 1969/78	DIESEL	4363cc.	A-F3L 1114 115HP		29
650600	2114 - Tractor A65 1969/78	DIESEL	4750cc.	A-F3L 2114 120HP		29
660200	913 1978/...	DIESEL	5106cc.	B-F5L 913 Ø102		37
650400	514, Tractor 470 1959/69	DIESEL	5320cc.	F4L 514 65HP Ø110		27
650700	1114 - Tractor A85 1969/78	DIESEL	5817cc.	A-F4L 1114 Ø115		30
650100	DD1000, DD9000 Camión, Tractor 1978/81	DIESEL	6128cc.	F6L 913 130HP Ø102		24
650700	2114 - Tractor A85 1969/78	DIESEL	6333cc.	A-F4L 2114 Ø120		30
650500	514 A110, Tractor 1959/69	DIESEL	7980cc.	F6L 514 Ø110		28
650800	1114, Turbo, Bus, Tractor, A130, A144 1969/78	DIESEL	8725cc.	A-F6L 1114 Ø115		31
650800	2114, Turbo, Bus, Tractor, A130, A144 1969/78	DIESEL	9500cc.	B-F6L 2114 Ø120		31
650900	200 D16, 200 D19, 200 D2M, 200 RS, 210 EV 120, 5020 1969/77	DIESEL	11309cc.	F8L - 413 V8 Ø120		32
651000	Estacionarios 0302 6472, AY 0148-00, 0301 7177 UY 0147-00, Vehicular Omnibus, Camiones, 0302 6545 AY 0148-00, 0301 7177 UY 0147-00	DIESEL	11309cc.	F8L - 413F V8 Ø125		33

DI TELLA

210900	Morris, Riley, Traveller 1500, Pick Up, Argenta 1500 1960/66		1489cc.	Ø73.02		131
210900	Magnette 1622, Morris 1650, Magnette 1960/66		1622cc.	Ø76.20		131

DKW

140000	Graciela, Auto Unión 1000S 1953/67		900cc.	Wartburg 44HP Ø73.5		132
140000	Graciela, Auto Unión 1000S 1953/67		992cc.	Wartburg 50HP Ø73.5		132

DODGE

Ver/See Chrysler

DYNAPAC

330800	Cilindro Vibratorio CHF 44 1983/...	DIESEL	2942cc.	D229-3 72HP Ø102		116
--------	-------------------------------------	---------------	---------	------------------	--	-----

FIAT

250100	600 (E.R.D), 770 Coupe, 800 Spider 1962/76		767cc.	100D - 170R 32HP Ø62		138
250800	133, Berlina de Lujo 1977/82, 850, 850 Van 1965/76		843cc.	100R 32HP Ø62.5 - 100G 37HP Ø65		147
250800	Uno 45 1974/..., 127 Especial 1983/88		903cc.	146A 45HP Ø65		147
270200	Palio 1.0 ED/EDX MPI 96		994cc.	ED/EDX MPI 48/61HP Ø76		176
260700	Uno Mille, Palio, Siena 1983/...		994cc.	146B 48/61HP Ø76		168
251095	Panda 1986/..., Uno 1989/95, Uno 1998/...		999cc.	146A2 - 156A2/A3 30/45HP Ø70		149
270500	Uno, Palio, Siena, Mille Fire		999cc.	Fire 8V MPI 50HP Ø70		181
270700	Palio, Siena, Palio Weekend, Palio Novo, Novo Siena, Doblo		999cc.	Fire 1714130 (DOHC) 16V 70HP Ø71		183
272200	Palio, Siena Generación III, Uno Fase II 2010/...		999cc.	Fire EVO 73/75HP Ø70		194



FIAT					
Ref.	Modelo/Model	Cm³	Motor/Engine		
260500	147, Oggi, Panorama, Uno , Premio Trend	1049cc.	127AB 206 60/70HP Ø76		166
250000	1100/103 1961/64	1089cc.	65HP Ø68.5		137
251095	Panda 1995/96, Palio 2001/...	1108cc.	176B2 - 178B9 54HP Ø70		149
250400	128, 147, Spazio, Brio, Ritmo 60, Strada 60 1971/...	1116cc.	128A 55/60HP Ø80		140
251795	Punto 60 Cabrio, Palio 75, Siena 1995/..., Punto 60, Punto Selecta 1993/99	1242cc.	176B4/176B1/176A7 60HP - 178B5 73HP Ø70.8		152
270700	Palio, Siena, Palio Weekend, Palio Novo, Novo Siena, Doblo	1242cc.	Fire 188.A5 (DOHC) 16V 80HP Ø71		183
271900	Fire 1.3, Fiorino, 500 2007/...	1242cc.	Fire Evo 350 A1 70HP Ø72		191
271500	Punto ELX JTD 2003/..., Strada Trekking Fase III JTD 2010/... DIESEL	1248cc.	188A9 (DOHC) 16V 70HP Ø69.6		189
250500	128, Europa, 147, Spazio 1971/81	1290cc.	128A1 73HP Ø86.4		142
260500	147, Oggi, Panorama, Uno , Premio Trend	1300cc.	127AB 2C 60/70HP Ø76		166
270500	Uno, Palio, Siena, Mille Fire	1300cc.	Fire 8V MPI 75HP Ø70.8		181
250500	Regata 70, Ritmo Strada 65, Uno 70, Iava, TV, 147 Sorpasso Fiorino 1982/...	1301cc.	138B2 68/70HP Ø86.4		142
260000	147, Duna, Fiorino, Spazio, Uno 1985/... DIESEL	1301cc.	4TD - 146B 45HP Ø76.1		161
452200	Qubo, Fiorino Qubo	1360cc.	75HP Ø75		361
271200	Palio, Siena, Strada	1368cc.	Fire 8V 80/81HP Ø72		187
271900	Fire 1.4 ELX, Evo 2010/..., Idea 2003/..., Palio Fase III/III 2007/13, Siena Generación III MPI 2002/..., Grande Punto, Linea 2005/..., Strada Fase III	1368cc.	Fire Evo 169 A4 77/80/82HP Ø72		191
271407	Bravo 1995/..., Marea 1996/00	1370cc.	182 A3 80HP Ø82		136
260200	Spazio, Duna, Tipo, Uno, Vivace, Palio, Siena 1988/91, Fiorino 1993/95	1372cc.	160A1 71HP - 146C1/5 67/72HP - 159A2 78HP Ø80.5		163
222407	Palio 2001/..., Siena 2002/...	1461cc.	178E5 Ø83		460
250200	1500 Berlina, Familiar, Multicarga 1963/69	1481cc.	115C 72HP Ø77		139
270200	Palio 1.5 EL MPI 96	1495cc.	EL MPI 76HP Ø76		176
250500	Ritmo Strada 75, Ritmo Strada 85 1978/82	1498cc.	138A2-A4 75/85HP Ø86.4		142
250600	128 Regatta '85, Ritmo1986/90, Duna, Uno, Super Europa 1983/..., Elba, Premio	1498cc.	138C3 75/85HP Ø86.4		144
252207	Regata 75 i.e, Ritmo 75 i.e, Uno 75 i.e 1986/90, Fiorino i.e 1988/93	1498cc.	149A5 - 149C1 - 138C3 - 483C3 75HP Ø86.4		134
260300	Duna, Uno, Regatta, Palio, Siena, Premio, Elba, Tipo, Fiorino 1988/...	1581cc.	Sevel - 146C6/159A3/160A2 75/78/82HP Ø86.4		164
260900	Palio, Siena, Tipo, Bravo, Marea, Multipla 1999/...	1581cc.	182A4 - 182A6 - 186A3 - 186A4 16V 103HP Ø86.4		170
250900	Regata 100S 1985/...	1585cc.	149A 100HP Ø84		148
261100	Palio, Siena, Marea, Multipla 2001/...	1596cc.	182B6 - 178E7 103HP Ø77 Torque 16V		171
272000	Idea Essence, Idea Sporting, Idea Adventure, Siena Fase III Essence, Strada Fase III Adventure, Palio Wend Fase III/IV Adventure, Adventure 2010/...	1598cc.	E-Torq 178D20.11 - 178D22.11 (SOHC) 16V 115HP Ø77		192
250200	1600 Berlina, Coupe 1969/72	1600cc.	115C 76HP Ø78		139
250700	125 (Bialbero), Berlina, Sport Multicarga, Mirafiori 1972/74	1608cc.	125AB - 125A 110HP Ø80		146
260400	Duna, Uno, Regatta, Fiorino 1985/... DIESEL	1697cc.	149B - 146B 60HP Ø82.6		165
270000	Fiorino, Uno, Tipo, Palio, Ducato D/TD DIESEL	1697cc.	149B - 176A 58/69HP Ø82.6		172
272100	Fiat Punto, Idea, Linea 2011/..	1747cc.	E-Torq (SOHC) 16V 130HP Ø81		193
260100	Tempra, Tipo 1992/95	1756cc.	835C 105HP Ø84		162
241800	Palio Fase II 2004/...	1781cc.	ALX (DOHC) 16V 122HP 80.5		43
242200	Stylo, Strada Working, Adventure, Palio 2003	1796cc.	OHC 171190 102HP Ø80.5		46
252300	Palio, Stilo, Strada, Siena Flex 2003/..., Idea Adventura HLX, G2/G3 2006/...	1796cc.	OHC-171190-17241C1-G2/G3 102/105/110HP Ø80.5		155
291000	Croma 2005/...	1796cc.	939A4 (DOHC) 16V 140HP Ø80,5		92
460900	Ducato TD 1994/..., Scudo TD 1995/01 DIESEL	1905cc.	D8B/DHX 92HP Ø83		370
461307	Escudo, Ducato 1994/01 DIESEL	1905cc.	D9B/DJY 68/69HP Ø83		331
252000	Brava, Bravo TD 1996/99, Marengo TD, Marea TD DIESEL	1910cc.	182A8/A7 75/100HP Ø82		153
252100	Brava, Bravo TD, Multipla TD, Marea TD 1998/... DIESEL	1910cc.	182 B4 105HP Ø82		154
252400	Marea JTD 2000/02, Stilo JTD, Idea JTD, Punto, Palio JTD 2002/... DIESEL	1910cc.	186 A6-192 A1/3-188 B2-182 B9 80/110/115HP Ø82		156
270000	Tipo, Tempra, Palio, Siena TD DIESEL	1929cc.	160D - 280A1 65/90HP Ø82.6		172
260100	Regatta 2000, Bialbero, Tempra 1989/...	1987cc.	154C 90/110HP Ø84		162
260600	Tempra 1992/..., Tipo i.e. 1989/93, Croma i.e 1993/..., Coupe i.e, Turbo 1994/...	1995cc.	160A 126HP - 154E 140HP - 836A 145HP Ø84		167
260800	Tempra i.e, Tipo i.e, Croma i.e, Croma i.e Turbo 1992/95	1995cc.	154C4.046 153HP - 159A6.046 115HP 115HP Ø84		169
270900	Marea 1996/98 - 1998/..., Coupe 1996/01, Bravo 1995/98	1998cc.	182A1 147HP - 182B3/B7 147/155HP Ø82		184
271300	Bravo, Coupe, Marea 1998/01	1998cc.	182B7 - 182B3 155HP Ø82		188
461500	Ulysse TD 1996/99 DIESEL	2088cc.	P8C (XUD11ATE/L) 12V 109HP Ø86		373
324800	Ducato 2006/... DIESEL	2198cc.	4HU 101HP Ø86		282



FIAT					
Ref.	Modelo/Model		Cm ³	Motor/Engine	
252800	Ducato JTD 2002/... - 2006/...	DIESEL	2286cc.	F1AE(DOHC) 16V 110/120/127HP Ø88	158
523000	Freemont 2012/...		2360cc.	ED3 - GEMA (DOHC) 16V 170/174HP Ø88	130
251807	Marea TD 1996/99	DIESEL	2387cc.	185A2 124HP Ø82	134
251495	Ducato TD 1985/...	DIESEL	2445cc.	8140.21 92HP Ø93	151
270400	Nuovo Ducato 1989/94	DIESEL	2445cc.	8140.67 55HP Ø93	179
270807	131/132 1978/..., Argenta 1981/..., Ducato 1981/89	DIESEL	2445cc.	8144.61 53HP Ø93	136
270100	Ducato TD 1990/94, Ducato TDS 1994/96, Ducato TDSE 1996/...	DIESEL	2499cc.	8140.27 103HP - 8140.47R/X230 110/116HP Ø93	174
270400	Ducato 1994/...	DIESEL	2499cc.	8140.67X230 85HP Ø93	179
252900	Ducato JTD 2006/09	DIESEL	2798cc.	8140.43S Euro III - Common Rail 122/125HP Ø94.4	159
251100	Ducato 14 - Ducato 18 Maxi - Ducato 14D - Ducato 18D Maxi 1998/...	DIESEL	2799cc.	8140.63 Iny. Indirecta 87/89HP Ø94.4	150
270300	Ducato 14TDS, Ducato Maxi 18TDS 1996/...	DIESEL	2799cc.	8140.43 122HP Ø94.4	177

FIAT IVECO					
252800	Cargo, Maxicargo, Furgon, Multijet 2010/...	DIESEL	2286cc.	F1AE(DOHC) 16V 110/120/127HP Ø88	158
251495	Daily TD 1985/89	DIESEL	2445cc.	8140.21 92HP Ø93	151
270807	Daily 1979/...	DIESEL	2445cc.	8140.61 Ø93	136
251495	Daily TD 1987/89	DIESEL	2499cc.	8140.27 103HP Ø93	151
270100	Daily Turbo 1990/...	DIESEL	2499cc.	8140.27S 103HP - 8140.47/S-47R 112/116HP Ø93	174
270400	Daily 30.8 - 35.8 1996/...	DIESEL	2499cc.	8140.67F37 82HP Ø93	179
252900	Daily 35.13, 35.13 4x4, 38.13,40.13, 50.13, 60.13, 70.13 2005/10	DIESEL	2798cc.	8140.43S Euro III - Common Rail 122/125HP Ø94.4	159
251100	Daily 30.8 - Daily 35.8 1996/...	DIESEL	2799cc.	8140.63 Iny. Indirecta Ø94.4	150
271100	Turbo Daily 35.10/49.12- 49.12 - 60.12 Intercooler - 45.10/49.10/40.10	DIESEL	2799cc.	8140.23 - 8140.43 Iny. Directa 99/122HP Ø94.4	185
252700	Daily, 40 S14, 3.0 HPI, Euro III TD, 55 C16, 3.0 HPI, Euro III TD 2008/...	DIESEL	2998cc.	8210 - 42E2 - F1CE 0481 136/155HP Ø95.8	157
800407	Tractor 780/880 1976/...	DIESEL	3666cc.	8045.04 Ø103	XXVI
800300	Camión 150 N Turbo AU130, Eurocargo 150 E23/E20	DIESEL	5861cc.	8060.25 177HP - 8060.45/45S 207HP Ø104	55
800600	75/80/85/95/100/120/130/150/170 E15 Turbo 1991/..., 80/85/100/120 130/135/150/170 E18 Turbo 1991/..., 80/90/100/E21, 135/150/170/180/E23	DIESEL	5861cc.	8060.25 143/177HP - 8060.45/S Eurocargo 207/277HP Ø104	59
800800	Eurocargo 80 E18/E21, 90 E18/E21 Tector, Common Rail Turbo Intercooler - EDC 130 E18, 120 E24/E28, 150 E18 2004/...	DIESEL	5880cc.	170E22 - F4AE0681D 24V TDI- EDC 180/210HP Ø102	61
800900	Eurotech Cursor 8 (E24/E31/E35), Eurotrakker Cursor 8 (E24/E27/E31 E35/T27/T31/T33/T35/T36), Stralis (S27/S30/S31/S33/S35/S36), Euromover Cursor 8 (E24), Cavallino Cursor 8 2007/...	DIESEL	8000cc.	F2BE0681 - F2BE3681 E4 - Turbo Intercooler 310HP Ø115	62
800200	Camión Bus 341A, 221/221H, 619 NP 1965/66, 693 N/N1-T/T1 1965/68	DIESEL	12883cc.	221- 8210.01 240HP Ø135	54
801000	Euro Stard Cursor 13 260E48, 440E46/48, Stralis 260/440S44, 190/260/440S48/260/440S50/54/56, Eurotrakker Cursor 13 190/260/340 380E38/E44-400/410/440/720E38/E44	DIESEL	13000cc.	F3BE3681A Turbo Intercooler 380/420HP Ø135	64
800000	Camión 619N1, 697N TB, Bus 391, 691, 319N, Bus 221A 1970/...	DIESEL	13798cc.	8210.02 260HP Ø137	51
800500	Euro Trakker, Euro Star, Euro Tech 1989/..., 180E42, 190E31/E42/E36, 240E42/E36, 260E37/E42/E36, 400E31/E37/E42, 410E37/E42, 440E37/E42, 720E31, 380E31 1991/...	DIESEL	13798cc.	8210.42L LE2 370HP - 8210.42K KE2 420HP 8210.22.800 310HP Ø137	57

FIAT TRACTOR - CAMION					
710200	Motor Arranque, Tractor 1955/74	DIESEL	665cc.	Motorino 55/60/788R Ø75	50
700600	Tractor U25 1957/62, Tractor 211R 1962/65	DIESEL	1135cc.	U25 - 211R - CD Ø85	45
700900	Tractor 411R/411T, 431R 1959/85	DIESEL	2270cc.	615 40HP Ø85	48
710305	Tractor	DIESEL	2592cc.	480-540T 100HP	XXVI
440000	850E	DIESEL	2977cc.	D225-4 68HP Ø95	119
700300	Tractor Someca, CN3 1961/70	DIESEL	3421cc.	650 - 700 Ø110	42
700800	Tractor 400 E.V.U, 500, Super 600E, 480 1969/80	DIESEL	3421cc.	CN3 Ø110	47
710405	Tractor Camiones	DIESEL	3455cc.	640-670-680 100HP	XXVI
700400	Tractor Someca, Leoncino 1950/...	DIESEL	3456cc.	DA - 50 - 40 Ø100	43
710505	Tractor, Camiones 780/780DT/765C/766/855	DIESEL	3663cc.	780/780DT Ø103	XXVI
700800	Tractor 400 E.V.U, 500, Super 600E, 480 1969/80	DIESEL	3705cc.	CN4 Ø110	47
310400	Escavadora FB80	DIESEL	3922cc.	D229-4 96HP Ø102	107 317
700000	Tractor Someca 1965/74	DIESEL	4156cc.	M45 - 450 - 55 Super Son Ø105	39
700300	Someca M45/M50, Super Som 55/46A, Tigrotto 1969/...	DIESEL	4397cc.	CO3 Ø108	42



FIAT TRACTOR - CAMION					
Ref.	Modelo/Model		Cm³	Motor/Engine	
440100	Tractor AD7B, 980E, S90	DIESEL	5100cc.	D225-6 102HP Ø95	120
700500	Tractor, CO3 1971/80	DIESEL	5401cc.	700E - 800E - CO3 - 640 - 740 90/106HP Ø115	44
310500	Tractor S90, FE105, FA120, FE105B	DIESEL	5883cc.	D229-6 145HP Turbo 160HP Ø102	109
700700	Tractor 1955/...	DIESEL	6546cc.	60 RL Ø122	46
700100	Tractor 1962/69	DIESEL	6872cc.	780 - R - AE Ø125	40
700200	Tractor - CP3 1972/80	DIESEL	7412cc.	840 - 900 - 1100 - CP3 - 900E 165HP Ø110	41
710100	Camión 1964/83	DIESEL	7412cc.	673N - CP - 840 - 900 Ø110	49
800100	Camión 203	DIESEL	10676cc.	682 N2 MK3 Ø125	53
FORD					
301307	Fiesta 1976/88		957cc.	OHV (HCS) 40/45HP Ø73.96	196
310700	Escort Hobby 1.0 1993/...		997cc.	CHT/AE Ø70.3	241
311000	Ka 1997/99, Fiesta 1996/99 53HP, Fiesta 1988/95 45HP		999cc.	OHV (HCS) Endura 45/53HP Ø68.7	244
340100	Ka 1999/...		999cc.	Zetec Rocam ZL 65HP Ø68.69	285
301307	Fiesta 1976/88, Escort 1982/88		1118cc.	OHV (HCS) 53/55HP Ø73.96	196
301307	Combi Van, Escort 1986/88		1297cc.	OHV (BL13H) 60HP Ø73.96	196
310800	Fiesta 1988/95, Courier 1991/... (cárter de aluminio)		1297cc.	OHV (HCS) Endura 60HP Ø73.96	242
310800	Fiesta, Ka (cárter de acero)		1299cc.	OHV (HCS) Endura 50/60HP Ø73.96	242
310800	Escort, Fiesta, Courier, Ka (cárter de aluminio) 1995/...,		1299cc.	OHV (HCS) Endura 50/60HP Ø73.96	242
310700	Escort 1.3 1983/...		1300cc.	CHT/AE Ø71.5	241
320600	Corcel 1971/77, Corcel II 1978/83		1300cc.	CHT 73HP Ø77	252
320900	Fiesta SE, Courier, Puma 1996/...		1388cc.	Zetec SE 16V 90/75HP Ø76	254
301095	Escort 1986/98, Orion 1986/94		1392cc.	HL14G/CFI/EFI 73/75HP Ø77.2	213
302100	Fiesta, Eco Sport TD 2003/..., Duratorq TDCI	DIESEL	1398cc.	F6JA - F6JB 68HP (SOHC) Ø74	222
320600	Belina, Coupe GT 1.4 BR		1400cc.	CHT Ø77	252
300700	Escort, Saveiro, Gol, Corcel II, Del Rey, Scala, Pampa, Belina, Verona 1983/...		1555cc.	CHT/AE 73HP Ø77	210
310600	Corcel II 1979/83, Belina II, Pampa 1982/83, Del Rey 1981/83, Scala 1983/...		1555cc.	CHT 73HP Ø77	240
471300	Focus C-Max TDCI 2003/..., Fusion TDCI 2004/...	DIESEL	1560cc.	G8DA 90HP - Duratorq 109HP (DOHC) 16V Ø75	385
330905	Capri, Cortina, Sierra, Transit, Pick Up, Granada 1973/...		1593cc.	OHC TL16L/TL16H/TL16G 63/73/90HP Ø87.65	200
321600	Fiesta, Fusión 2003/..., Focus 2004/..., C-Max 2007/...		1596cc.	L4 Sigma 74HP - HWDA/HWDB - FYJA 100HP Ø79	260
300600	Sierra 1.6L 1984/...		1597cc.	OHC 75HP Ø81.3	209
301100	Fiesta i, Orion i 1989/92, Escort, Escort XR3 1980/85, Fiesta XR2 1984/85, Escort, Orion, Escort XR3i 1985/90		1597cc.	CHV (HL16CFI) 90HP - CVH (H16G/MFI/16H) 79HP CVH (HL16I) 105HP - CVH (HL16G/H) 79/96HP Ø80	214
301200	Mondeo 1993/...		1597cc.	ZETEC 16V 90HP Ø76	215
301400	Escort, Orion 1992/..., Fiesta 1994/95		1597cc.	ZETEC 16V 90HP Ø76	216
340200	Ka 1997/..., Fiesta 1999/..., Escort, Eco Sport, Focus, Courier 2003/...		1598cc.	Zetec Rocam ZL 95/105/110HP Ø82	286
320000	Fiesta, Courier, Escort, Mondeo, Orion, Sierra, Mondeo TD, Escort TDI	DIESEL	1753cc.	D1.8 T/TI 60/75/90HP Ø82.5	247
340300	Focus TD di 1998/..., Fiesta TD di 2000/..., Focus TD ci 2001/...	DIESEL	1753cc.	Lynx (C9DC) 75/90HP - Duratorq 115HP Ø82.5	287
220600	Del Rey, Belina, Escort, Scala, Pampa, Verona, Royale, Versailles 1989/...		1781cc.	AP 85/87HP Ø81	466
301500	Focus 1998/...		1796cc.	ZETEC E (DOHC) 16V 116HP Ø80.6	217
303300	Focus 1998/04, Transit 2002/...		1796cc.	ZETEC-E SFI (DOHC) 16V 116HP Ø80.6	233
320300	Escort, Fiesta, Orion, Fiesta XR2, Escort RX3i 1992/...		1796cc.	ZETEC 16V 105/115HP Ø80.6	250
321300	Mondeo 1993/...		1796cc.	ZETEC (DOHC) 16V 115HP Ø80.6	258
322200	Courier 1972/82		1800cc.	110 104HP Ø78	265
223500	Galaxy TDI 2000/...	DIESEL	1896cc.	AUY 115HP Ø79.5	486
230900	Galaxy TDI 1995/... - 1997/...	DIESEL	1896cc.	VW19N (1Z/AHU) - VW19P (AFN) 90/110HP Ø79.5	499
322200	Courier 1972/82		1900cc.	121 104HP Ø78	265
230000	Galaxy, Versailles, Verona, Escort 1992/96		1984cc.	Audi 827 107/115HP Ø82.5	492
302900	Focus 1999/02, Maverich 2000/..., Cougar 1999/...		1989cc.	YF/EDBA/EDBB/EDBC/EDBD 124/131HP Ø84.8	229
320500	Escort		1989cc.	ZETEC 16V 136HP Ø84.8	251
321500	Mondeo 1993/01		1989cc.	ZETEC (DOHC) 16V 136HP Ø84.8	259
340800	Contour 1994/...		1989cc.	ZETEC 16V 126HP Ø83	292
300300	Taurus L, GXL, Ghia 1974/...		1990cc.	OHC 63HP Ø89.32	206
303600	Ranger, Pinto, Taurus, Sierra, Capri, Granada 1974/86		1993cc.	L4 122 (SOHC) 8V 72HP Ø96	235
340005	Granada, Transit, Escorpio, Sierra, Capri, Taurus 1970/...		1993cc.	OHC TL20L/H 102/105HP Ø91	200



FORD					
Ref.	Modelo/Model		Cm ³	Motor/Engine	
303200	Mondeo TDCI 2000/02 - 2002/..., Mondeo III DI 2002/02, Transit TDI-TDCI 2000/02 - 2002/..., Transit DI 2000/02	DIESEL	1998cc.	HJBA/B/C - F3FA/F1FA 85/125HP - ABFA 100HP - D3FA/D5BA/D6BA 75/90/115HP Duratorq Ø86	232
324300	Contour 1996/98, Mystique 1994/95, Escort ZX2 1998/...		1998cc.	4L 121 P.C.D. VIN "3" ZETEC 16V 138HP Ø84,8	279
471400	C-Max TDCI 2003/..., Focus TDCI, Galaxy TDCI, S-Max 2006/..., Mondeo TDCI, C-Max TDCI, Focus TDCI 2007/...	DIESEL	1998cc.	DURATORQ (20DD0X) 110/115/130/135/140HP Ø85 (DOHC) 16V	386
471500	Focus C-Max TDCI 2003/...	DIESEL	1998cc.	G6DA/G6DC 135HP Ø85	387
302200	Mondeo 2001/..., Eco Sport 2003/..., Ranger 2001/..., Focus, Focus EXE		1999cc.	CJBA 145HP - Duratec HE/EFI 143/145HP Ø87.5	223
302400	Mondeo 2001/..., Eco Sport 2003/..., Ranger 2001/..., Focus, Focus EXE		1999cc.	CJBA 145HP - Duratec HE/EFI 143/145HP Ø87.5	225
322200	Courier 1972/82		2000cc.	123 104HP Ø78	265
323107	Escort 1997/01		2000cc.	110 8V	200
300800	A/AA 1928/31		2100cc.	24HP Ø98.4	211
324800	Ranger XL 4X2 / 4X4, Transit TDCi 2006/...	DIESEL	2198cc.	Puma TDCi - CVRA/CVRB/CVRC 125/155HP Ø86	282
302400	Maverick 2003/...		2261cc.	154HP Ø87.5	225
340600	Mustang, Ranger 1993/94, Ranger 1995/97, Pick Up 1989/...		2298cc.	F140L (SOHC) 8v 106HP Ø96	290
300400	Taurus, Sierra, XR4, Falcon, GXL/GT, SP/Ghia, Maverick 1974/..., Mustang 1980/...		2299cc.	OHC 100/114HP Ø96	207
301700	Ghia 1991/..., Topaz 1989/94		2300cc.	140 F.I	218
301800	Topaz, GS/GLX 1984/88		2300cc.	140 Carburado	219
303600	Ranger, Pinto, Taurus, Sierra, Capri, Granada 1974/86		2302cc.	L4 140 (SOHC) 8V 86HP Ø96	235
910500	Bronco II TD, Ranger 2WD 1985/...	DIESEL	2346cc.	4D55T 67HP Ø91	
302000	Transit TD 2000/...	DIESEL	2402cc.	Duratorq (DOHC) 16V 120/125HP Ø89.9	221
302500	Mystique, Contour 1995/00, Mondeo 1994/00, Mondeo III 2000/...		2495cc.	Duratec - LCBV V6 24V (DOHC) 170HP Ø81.6	226
303500	Mondeo III 2002/...		2495cc.	AJ25 - LDBE V6 (DOHC) 24V 170HP Ø81,6	234
330300	Transit, Transit D/DI 1985/99	DIESEL	2496cc.	4EB/BC/CA/FB 70/80HP - 4HC/EA 100HP Ø93.64	284
971907	Probe 1992/95		2497cc.	KL 170HP (DOHC) V6 24V Ø84.5	202
500400	Scorpio TDI, Granada TDI 1993/94, Falcon 1988/...	DIESEL	2499cc.	SCB 115HP Ø92	455
520300	Scorpio TDI SCC/SCD 1994/98	DIESEL	2499cc.	SCC/SCD 115/125HP Ø92	456
971607	Ranger D/TD 1998/...	DIESEL	2499cc.	WL 78HP WLT 108HP Ø93	202
302300	Pick Up, Ranger 1997/...		2500cc.	EFI - NAI4 (SOHC) 8V 117HP Ø96	224
430000	Ranger TDI 1995/...	DIESEL	2507cc.	95HP Ø90.7	314
324700	Focus, C-Max, S-Max, Mondeo, Kuga 2005/... - 2007/...		2522cc.	Duratec (25KDDTD) 220/226/300HP Ø83	281
303000	Mondeo II 1994/00		2544cc.	Duratec SEA (DOHC) 24V 170/173HP Ø82.4	230
920200	Maverick TD 1992/99	DIESEL	2663cc.	TD27T 100/125HP Ø96	
430600	Ranger TD BR 2000-2002/...	DIESEL	2758cc.	Power Stroke 135HP Ø93	315
300900	Falcon 4B, STD, De Luxe, Futura, Rural 1962/68		2780cc.	170 4B 84HP Ø88.9	212
230700	Galaxy 1995/00		2792cc.	VV28 V6 175HP Ø81	498
322400	Bronco, Granada, Capri 1983/86		2792cc.	171 V6 160HP Ø93	267
430800	Ranger 3.0I, 4 x 4, Full BR Intercooler 2005/8	DIESEL	2798cc.	NGD 3.0 E (SOHC) 16V 163HP Ø96	316
310900	V6 (USA) Ranger, Bronco II, Sierra V6 B4A/B/C 1988/93, Granada BRC 1986/93		2933cc.	177/BRC V6 150HP Ø93	243
303100	Mondeo V6, ST 2.20 2003/...		2967cc.	Duratec V6 - MEBA V6 (DOHC) 24V 226HP Ø89	231
322900	Escape 2001/04		2967cc.	Duratec V6 RFF - MEBA 3.0I 200HP Ø89	272
323700	Camioneta Ranger 1996/01		2968cc.	Vulcan V6 147HP Ø89	275
300000	Falcon, F100, Fairlane 1969/...		3052cc.	187 - 7B 108HP Ø90.62	203
300900	Falcon 4B, STD, De Luxe, Futura, Rural 1962/68		3052cc.	187 4B 96HP Ø90.42	212
300000	Falcon, F100, Fairlane 1969/...		3075cc.	188 - 7B 108HP Ø93.47	203
324900	Ranger XLS/XLT 4x2-4x4 TDCi 2013/...	DIESEL	3198cc.	Puma TDCi I5 eTGV 200HP Ø90	283
400000	F100, Falcon 1970/...	DIESEL	3336cc.	4.203-P4-192Z 71HP Ø91.49	322
410000	F100	DIESEL	3336cc.	4.203 Potenciado 71HP Ø91.44	324
300000	Falcon, F100, Fairlane 1969/...		3618cc.	221 - 7B 108HP Ø93.47	203
300100	Falcon SP, Sprint 1973/...		3618cc.	221 Sprint 7B 132HP Ø93.47	204
310000	Falcon, Pick Up 1989/...		3618cc.	Max Econo 106HP Ø93.47	236
322300	Thunderbird, Cougar Super Cargado, Taurus, Sable 1988/93		3797cc.	232 V6 140/205HP Ø97	266
323200	Windstar 1995/96		3797cc.	232 V6 200HP Ø97	273
323300	Windstar 1997/98		3797cc.	Essex V6 155HP Ø96.8	274
323900	Windstar 1998/...		3797cc.	Essex V6 145HP Ø96.8	276



FORD					
Ref.	Modelo/Model		Cm³	Motor/Engine	
324000	Windstar 1999/00		3797cc.	Essex V6 200HP Ø96,8	277
324100	Windstar 2001/03		3797cc.	Essex V6 200HP Ø96,8	278
301900	V6 3.8 (USA) Mustang, Taurus, Sable, Thunderbird, Cougar 1985/87		3811cc.	232 V6 130HP Ø96.8	220
320200	V6 3.8 (USA) Mustang, Taurus, Sable, Thunderbird, Cougar		3811cc.	230 (232) V6 130HP Ø96.8	249
870000	F100 1998/...	DIESEL	3900cc.	4B - 4BT - 4BTA 100/130HP Ø102	15
870500	F100 2006/..., Common Rail	DIESEL	3920cc.	ISBe 150/170HP Ø102	21
310400	F100 1993/95, F1000 1994/96	DIESEL	3922cc.	D229-4 96HP Ø102	317
320100	Explorer, Ranger, Navajo 1991/..., Bronco II 1990/91		3996cc.	244 CID V6 (SOHC) 147/165HP Ø100.4	248
324400	Econoline, F150 1997/98		4195cc.	Essex V6 202HP Ø96,8	280
330600	F100 GMC Turbo 1999/...	DIESEL	4200cc.	Sprinter 6.07 TD 167HP Turbo Intercooler 198HP Ø93	320
321800	Galaxy 500, Fairlane, Falcon, Maverich, Mustang, Grand Marquis, F150/F250		4300cc.	260 V8 16V Ø96	261
300200	F100/350/600 - Fairlane 1961/70		4458cc.	272 V8 F1 170HP Ø92	205
302700	E-Series - Mustang, Grand Marquis, Crown Victoria, Pick Up F250 1997/99		4600cc.	Triton 281V8 180HP Ø92	227
302800	E-Series - Mustang, Grand Marquis, Crown Victoria, Pick Up F250 2000/03		4600cc.	Triton 281V8 180HP Ø92	228
322500	E-Series - F-Series, Expedition, Triton1997/99		4600cc.	Triton 281 V8 180HP Ø92	268
322600	Triton 2000/03, E-Series, F-Series, Expedition		4600cc.	281V8 180HP Ø92	269
340700	Town Car, Grand Marquis, LTD Crown, Victoria 1991/..., Thunderbird 1994/95		4600cc.	281 CID V8 180HP Ø92	291
300200	F100/350/600 - Fairlane 1961/70		4785cc.	292 V8 F1 170HP Ø95.25	205
300500	F100/350/600, Fairlane 1/8, LTD 500, Fase II 1969/76		4785cc.	V8 FII 180HP Ø95.25	208
321800	Galaxy 500, Fairlane, Falcon, Maverich, Mustang, F150/F250 1965/84		4800cc.	289 V8 16V Ø96	261
310200	Econoline, Delivery 1980/...		4900cc.	145HP Ø101.09	238
340900	F100/F150 1991/...		4900cc.	300 CID Inyección 145HP Ø101.6	293
310100	Ranger 1989/..., Galaxy, Maverick 1976/83		4942cc.	F302 - V8 Ø101.6	237
320700	Cougar, Continental, Granada, Fairmont, Thunderbird		5000cc.	F302 V8 Ø101.6	253
321000	F100/F250/F350, Mustang, Thunderbird, Bronco 1983/96		5000cc.	F302L V8 Ø101.6	255
321200	F250/F350, Mustang		5000cc.	F351W V8 Ø101.6	257
321800	Galaxy 500, Fairlane, Falcon, Maverich, Mustang, F150/F250 1965/84		5000cc.	302 V8 16V Ø96	261
321900	Cougar, Thunderbird, F200/F350 1991/95		5000cc.	302 V8 Ø96	262
322100	Grand Marquis, Galaxy, Camiones, Mustang, F250/F350/FB600 1969/84		5000cc.	351 V8 Ø101.6	264
400300	F100 1974/...	DIESEL	5004cc.	6PF - 305 102HP Ø91.44	124
310300	Fairlane 500, Galaxy 500, Monterey, Thunderbird, Mustang 1960/71		5400cc.	390 CID V8 Ø102	239
311100	Galaxie, Mustang, Torino 1964/78		5400cc.	330 V8	245
311200	V8 1964/72		5400cc.	350 V8	246
322500	E-Series - F-Series, Expedition, Triton1997/99		5408cc.	Triton 330 V8 260HP Ø92	268
322600	Triton 2000/03, E-Series, F-Series, Expedition		5408cc.	330 V8 260HP Ø92	269
322000	F250/F350/F600, Microbus (Chasis) 1984/91		5500cc.	335 V8 16V Ø101.6	263
321100	F100/F250/F350, Bronco 1985/95		5800cc.	F351WL V8 Ø101.6	256
322000	F250/F350/F600, Microbus (Chasis) 1984/91		5800cc.	351 V8 16V Ø101.6	263
311100	Camión 1964/78		5900cc.	351 V8	245
311100	Camión 1964/78		6400cc.	391 V8	245
322700	Triton F-450 1997/99, Excursion, E-Series, F-Series Super Duty		6760cc.	Triton V10 310HP Ø90	270
322800	F-450 2000/03, Excursion, E-Series, F-Series Super Duty		6760cc.	Triton V10 310HP Ø92	271
340400	F100/F250/F350, Econoline 250/350 1985/87		7500cc.	F460L V8 Ø110	288
340500	Monterey, Torino, Cougar, Continental, Mark III/IV/V 1988/94		7500cc.	460 CID V8 Ø110	289
FORD TRACTOR - CAMION					
330000	Tractor 4600/4110/4140/4190/4200/4400/4410/4610/4610H/4610SU	DIESEL	3294cc.	BSD 332 - 333/H 81HP Ø111.8	65
870000	F4000 2000/..., Cargo 915, Euro II	DIESEL	3900cc.	4B - 4BT - 4BTA 100/130HP Ø102	15
310400	F4000 1992/93, F2000 1980/..., FB4000 1985/...	DIESEL	3922cc.	D229-4 96HP Ø102	107 317
320400	Camión F4000 1986/...	DIESEL	4156cc.	D226-4 82HP Ø105	111
330100	5610/5030/5110/5610/5900/6600/6700/7000/7100/7200	DIESEL	4196cc.	BSD 442 - 256 72HP Ø111.8	66
330400	Euro I/II/III	DIESEL	4300cc.	4.10 X10 90HP - 4.10T/TCA 133/167HP Ø103	113
330100	6410/6610/6710/7600/7700	DIESEL	4385cc.	BSD 444 80HP Ø111.8	66
330100	6810/7410/7610/7710	DIESEL	4392cc.	BSD 444T 82HP Ø111.8	66
330100	F2000/F4000, FB4000, Tractor 6600/6610	DIESEL	4393cc.	268 82/87HP Ø111.8	66



FORD TRACTOR - CAMION

Ref.	Modelo/Model		Cm ³	Motor/Engine		
400100	F350/600	DIESEL	5004cc.	6.305 Cadenero 100HP Ø91.44	122	
400300	F350/600 1974/...	DIESEL	5004cc.	6PF - 305 102HP Ø91.44	124	
410100	F600	DIESEL	5004cc.	6PF - 305 Potenciado 100HP Ø91.49	137	
400200	F600/700	DIESEL	5798cc.	6.354-2 140HP Ø98.47	123	
400400	F7000 Camiones - Ford pesados y semi-pesados	DIESEL	5798cc.	6.354-4 Turbo 172HP Ø98.42	125	
400900	F600/700	DIESEL	5798cc.	6.354-1 135HP Ø98.43	128	
410900	F600/750/1100, MF3366, F6000/F7500/F11000	DIESEL	5840cc.	6-357 Veh. 120HP - Agr. 91HP - Ind. 108HP Ø104.14	145	
420000	F400/F600/F7000/F11000/F12000/F13000	DIESEL	5840cc.	6-358 Veh. 133HP - Agr. 118HP - Ind. 127HP Ø104.14	146	
310500	F14000/F4000 1994/96, Cargo, F12000/F14000 1985/...	DIESEL	5883cc.	D229-6 145HP Turbo 160HP Ø102	109	
870100	F14000 Turbo, F4000 1999/..., 1416 Euro I, Dodge Truck 359 1989/93	DIESEL	5900cc.	6B - 6BT - 6BTA 180/205HP Ø102	17	
650100	F7000 1978/81	DIESEL	6128cc.	F6L 913 130HP Ø102	24	
330700	F14000 1995/98, Euro I/II	DIESEL	6450cc.	6.10 X10 139HP - 6.10T/TCA 201/250HP Ø103	114	
330200	7810/7910/8210/8530/8630/8750/8830, Fase I-II - Cargo 6.6/7.8	DIESEL	6572cc.	Fase I-II Cargo 6.6/7.8 Simples/Turbo 110HP Ø111.8	67	
870600	Cargo 2003/...	DIESEL	8270cc.	ISCe6 24V 315HP Ø114	22	
870200	Cargo 1722/1730/2625 1998/..., F14000 1999/...	DIESEL	8300cc.	6C - 6CT - CTA 254/294HP Ø114	19	
870307	Cargo 1722 - 1730 - 2625 1998/... - F14000 1999/...	DIESEL	8300cc.	6C - 6CT - CTA 254/294HP Ø114	XXVIII	

HANOMAG

750100	Tractor, D28LA/D28 1950/55	DIESEL	2800cc.	R25 - L28 - R35 - R40 - R435 Brillant Ø90	70	
750200	Brillant, Tractor, D28C 1965/71	DIESEL	2800cc.	R40 25e - R57 - R46 Ø90	71	
750000	Tractor, D57 1963/...	DIESEL	5702cc.	R45/55/60/75 Ø110	69	

HONDA

861100	Civic 1975/79		1169cc.	EB1 60HP Ø70		
861100	Civic 1975/79		1238cc.	EB2/3 60HP Ø72		
861100	Civic Van 1979/82, Civic, Ballade 1982/...		1335cc.	EN 70HP Ø72		
862300	Fit BR 2003/..., City 2004/..., Jazz 2005/...		1339cc.	I-DSI Twin Spark - L13A3/A5 (SOHC) 8V 82HP Ø 73		
860300	Civic CVCC 1987/90		1343cc.	D13B1/B2 (SOHC) 16V 75/90HP Ø75		
860300	CRX 1988/91		1493cc.	D15B6 (SOHC) 16V 90HP Ø75		
862500	Fit VTEC 2007/..., Jazz VTEC 2006/...		1496cc.	L15A1 - L15A6 81/105HP Ø73 (SOHC) 16V		
860400	Civic Coupe VTEC, Civic Del Sol VTEC, Civic VTEC, CRX VTEC 1991/97		1590cc.	D16Z6 - D16Z7 - D16Z9 125HP Ø75		
860500	Civic CRX, Integra 1985/87		1590cc.	ZC1 - ZV (DOHC) 16V 120HP Ø75		
860600	Accord 1980/81		1602cc.	EP 12V 90HP Ø77		
860700	Accord, Quinet 1981/...		1602cc.	EP 90HP Ø77		
861600	Civic EX VTEC 2001/..., Civic VTEC, Civic Coupe VTEC 2001/...		1668cc.	D17A5 - D17Z3 (SOHC) 16V 125/130HP Ø75		
860600	Prelude, Accord 1980/81		1750cc.	EK 12V 95HP Ø77		
860700	Accord, Prelude - Vigor 1982/...		1750cc.	EK - EL 97HP Ø77		
862700	Civic Sedan, Coupe 2006/11		1799cc.	R18A1/A2 140HP Ø81 (SOHC) 16V		
860800	Accord 1993/...		1850cc.	F18A3 (SOHC) 16V 116HP Ø85		
860900	Accord VTEC 1999/...		1850cc.	F18B2 - F18B3 136HP Ø85		
861400	CR-V 1997/98, CR-V 1999/...		1973cc.	B20B2/B3 - B20Z1/Z3/Z9 (DOHC) 16V 128/147HP Ø84		
860200	Civic TD 1997/99, Accord TD 1996/00	DIESEL	1994cc.	20T2R - 20T2N 86/105HP Ø84.5		
860800	Accord 1993/...		1997cc.	F20Z1 131HP - F20Z2 (SOHC) 116HP 16V Ø85		
860900	Accord VTEC, Accord Coupe VTEC 1998/..., Accord Aerodeck, Coupe 1994/97		1997cc.	F20B3 137HP - F20B5 - F20B6 147HP Ø85		
862800	CR-V 2002/06, Civic VI/VII VTEC 2003/..., Integra VTEC 2002/...		1998cc.	K20A (I-VTEC) 150HP - K20A3 155/160HP Ø86		
862900	Accord, Accord Tourer 2003/06, Stepwagon VTEC 2005/...		1998cc.	K20A6 16V 155HP Ø86		
860900	Prelude VTEC, Accord Wagon, Accord Aerodeck, Coupe, Wagon 1994/98		2156cc.	F22B1 130/145/150HP- F22B4/B5/B8 150HP Ø85		
861500	Accord, Typer 1998/.		2156cc.	H22 A4/A5/A7 (DOHC) 16V 212HP Ø87		
861200	Prelude VTEC 1993/96, Accord 1991/98		2157cc.	H22 A1/A2 (DOHC) 16V 185HP Ø87		
861300	Prelude VTEC 1997/00, Prelude VTEC H22 A5 1997/..., Accord Type R16 1998/...		2157cc.	H22 A4/A5/A7 (DOHC) 16V 185/195/212HP Ø87		
861000	Accord, Prelude 1992/96		2259cc.	H23A1/2/3 (DOHC) 16V 158/160HP Ø87		
862800	CR-V EX/LX/SE VTEC 2002/06, CR-V II VTEC 2002/06, CR-V III VTEC 2007/...		2354cc.	K24A1 160/170HP Ø86		

HYUNDAI

990600	HB20 2012/...		998cc.	Kappa FFV (DOHC) 12V 75/80HP Ø71		
990000	Santro 1997/..., Atos 1998/...		999cc.	G4HC (SOHC) 12V 56HP Ø66		
990300	Atos 2003/..., Santro 2003/05		1086cc.	GHHD (SOHC) 12V 63HP Ø67		



HYUNDAI					
Ref.	Modelo/Model	Cm³	Motor/Engine		
990500	Atos 2006/10	1086cc.	G4HG 62HP Ø67 (SOHC) 12V		
990400	Verna 2000/02	1495cc.	G4EK 92HP Ø75.5 (SOHC) 12V		
990800	Elantra 2006/..., Getz 2009/..., HB20, i30, Veloster 2012/...	1591cc.	GAMMA FFV (DOHC 16V) - 122/128HP Ø77		
990107	Coupe 1997/... - Elantra .../1998	1599cc.	G4DR 16V 84/114HP Ø77.4		
460300	Lantra 1998/..	DIESEL 1905cc.	XUD9 68HP Ø83		364
461307	Lantra 1998/...	DIESEL 1905cc.	XUD9 68HP Ø83		331
990700	i30 2007/..., Tucson 2004/11	1975cc.	G4GC 144HP Ø82		
910500	H100 D 1996/98, H100TD 1998/..., H1 - H1 TD 1997/...	DIESEL 2476cc.	D4BA/X - D4BH - D4BF 75/80/85HP Ø91.1		
910500	H1 1997/..., H100D 1998/...	DIESEL 2607cc.	D4BB 85HP Ø91.1		
IKA					
540000	Jeep Continental, Bergantin 1954/74	2470cc.	4L - 151 80HP Ø84.14		401
540200	Torino, Rambler, Utilitario, Gladiator, Jeep T80 1966/73	2966cc.	OHC 181 4B - 300/300S/380 Ø84.94		403
540400	Rambler, Torino Tornado 300SL, Gladiator 1966/73	2966cc.	OHC 181/230/300 140/160HP Ø84.94		405
540100	Estanciera, Gladiator, Continental, Kaiser Carabela, Bergantin Super	3705cc.	L226 110HP Ø84.14		402
540300	Torino 1973/...	3770cc.	OHC 181/230/300/380 7B Ø84.94		404
540500	Torino Tornado Reforma 1972/74	3770cc.	OHC 4B 180HP Ø84.94		406
INDENOR					
500200	404, T4B, T5B, Rastrojero 1972/...	DIESEL 1948cc.	XD/XDP 4.88 50/59HP Ø88		391
500907	Indenor	DIESEL 1948cc.	XD 4.88 con rebaje 50/59HP Ø88		391
500600	504 1980/..., J7/J9 1980/87	DIESEL 2112cc.	XD-XDP 4.90 59HP Ø90		394
500707	Indenor 1972/...	DIESEL 2112cc.	XD3 76/90HP Ø94		391
450400	504D 1976/93, 505D/505TD, J9D 1979/..., 604TD, J7D 1977/...	DIESEL 2304cc.	XD2 - XD2P 70/73HP Ø94		345
450400	504 1987/..., 505 1982/93, J9 1986/94	DIESEL 2498cc.	XD3 - X3DP 76/90HP Ø94		345
500300	Pick Up, Camiones Livianos 1976/...	DIESEL 3168cc.	XDP 6.90 95HP Ø90		393
INTERNATIONAL MAXION					
430000	Range Rover, Discovery, Defender 1990/94 - 1994/98, Sprinter 1997/...	DIESEL 2495cc.	200/300 TDI 112HP Ø90.5		314
430000	Ranger TDI 1995/..., Blazer TDI, S10TDI 1995/...	DIESEL 2507cc.	95HP Ø90.7		314
430600	Ranger TD BR 2000-2002/...	DIESEL 2758cc.	Power Stroke 135HP Ø93		315
430800	Ranger 3.0l, 4 x 4, Full BR Intercooler 2005/8	DIESEL 2798cc.	NGD 3.0 E (SOHC) 16V 163HP Ø96		316
410600	GM D10, F350, VW6.80, Case 550	DIESEL 3860cc.	4.236 lny. Directa 70HP Ø98.4	142	325
280300	GM D20/D40, Pick Up D20	DIESEL 3990cc.	Maxion S4 102HP Ø100		62
401100	MF290/292/610/620	DIESEL 4100cc.	P4000-4000T 72/86HP Ø100	130	
ISUZU					
242607	I- Mark 1987/...	DIESEL 1468cc.	4EC1 50HP Ø76		15
242607	Gemini 1987/..., I-Mark, Gemini TD 1988/...	DIESEL 1488cc.	4EC1- T4EC1 50/76HP Ø76		15
860900	Oasis 1995/97	2156cc.	RJ1 140HP Ø82		
280400	Luv, Pick Up 1986/92	DIESEL 2254cc.	4ZD1 88HP Ø89.3		63
240700	Trooper 1988/92	DIESEL 2499cc.	4JA1 76HP Ø93		32
240700	Trooper, Trooper TD 1988/92	DIESEL 2771cc.	4JB1 - 4JB1T 87 /102 HP Ø93		32
930500	Tropper, Tropper TD 1988/92	DIESEL 2771cc.	4JB1-T 87/102HP Ø93		
930300	Tropper TD, Campo TD 1991/...	DIESEL 3059cc.	4JG2 105HP Ø95.4		
930600	Trooper TD 1991/98, Monterey TD, Campo D, Brava TD 1992/...	DIESEL 3059cc.	4JG2 - 4JG2T - 4JG2TC 105/114/125HP Ø95.4		
930100	ELF 250 (TLD/KT) 1982/..., ELF 350 (KS/BE) 1984/...	DIESEL 3268cc.	4BC2 - 4BD1 87/88HP Ø102		
IVECO					
					Ver/See Fiat Iveco
JEEP					
					Ver/See Chrysler
JOHN DEERE					
850000	1030/1035/1520/1530/204, JD302 1973/...	DIESEL 2696cc.	3164D Ø102		73
850100	Tractor Equipos Viales 2120/2030/2035/2270/2280/2340, JD310/401 440/450/480 1974/..., 2130/2135/1640/1840/2140/JD4400/540B/550/555 1980/...	DIESEL 3590cc.	4219 D 81HP Ø102		74
850100	Tractor Equipos Viales 2120/2030/2035/2270/2280/2340 - JD310/401 440/450/480 1974/... - 2130/2135/1640/1840/2140/JD4400/540B/550/555 1980/...	DIESEL 3918cc.	4239 D/T 81HP Ø102		74
850700	Motores Agrícolas e Industriales	DIESEL 4500cc.	4540TJ31 107HP - 4045DJ31 74HP Ø106		80
850300	3420, J10, 4420, 570, Tractor Motoniveladora 1972/...	DIESEL 4976cc.	303 85HP Ø98.04		76
850300	3420, J10, 4420, 570, Tractor Motoniveladora 1972/...	DIESEL 5393cc.	329 87HP Ø102		76



JOHN DEERE					
Ref.	Modelo/Model		Cm ³	Motor/Engine	
850200	Tractor Motoniveladora 6329D, 3120/3130/3135/2840/630/730/JD303 444/540/570/482/6359D, 3140/3040/3640/4040/960/975/2940/3050/3350/3650	DIESEL	5395cc.	6.329D 87HP Ø102	75
850600	6505/6605/6615/7500, Power Tech, MUM, Power Tech, Gen Set	DIESEL	5395cc.	6068TJ31/32 - 6068TJ61/HJ63 150/178HP Ø106	79
850200	Tractor Motoniveladora 6329D, 3120/3130/3135/2840/630/730/JD303 444/540/570/482/6359D, 3140/3040/3640/4040/960/975/2940/3050/3350/3650	DIESEL	5877cc.	6.359D 87HP Ø106.5	75
850400	3350/3550/6500/6600/7500, Cosechadora 1075 1991/...	DIESEL	5879cc.	6359D 110/125HP Ø106.5	77
850500	730, Tractor 375 1960/74	DIESEL	6156cc.	Ø155.58	78

KIA					
971300	Pride 1995/...		1323cc.	B3 (SOHC) 16V 73HP Ø71	
911100	Sephia 1996/...	DIESEL	1498cc.	B5 (DOHC) 16V 105HP Ø78	
990700	Sportage 2004/2006, Cerato 2004/...		1975cc.	G4GC 144HP Ø82	
910100	Sportage TD 1996/...	DIESEL	1998cc.	RF 83HP Ø86	
900900	Besta 1992/97	DIESEL	2184cc.	HW 72HP Ø86	
910700	Pregio, K2500 2001/05, Bongo 2006/...	DIESEL	2476cc.	D4BH 94/97HP Ø91 (SOHC) 8V	
910000	Besta 1993/...	DIESEL	2700cc.	VN 81HP Ø96	
911007	Besta GS - Besta GS Grand 2000/...		2956cc.	JTA 85HP Ø98	

LADA					
970600	2101/2102 1970/...		1198cc.	OHC 60HP Ø76	296
970600	2103/2107 1972/...		1452cc.	OHC 75HP Ø76	296
970500	2106/2107/2121, Niva 2121 1976/..., Aleko 2141 1990/...		1568cc.	BA3 78HP Ø79	295
970700	Vaz 21213, Niva 21213 1994/...		1690cc.	OHC - 17LTBI 80HP Ø82	297
460300	Niva 2121, Aleko 1990/...	DIESEL	1905cc.	XUD9 65/68HP Ø83	364
290900	110 GTI 1996/...		1998cc.	C20XE 16V 150HP Ø86	91

LANCIA					
251795	Ypsilon 1996/00		1242cc.	840A3 60HP Ø70.8	152
270700	Ypsilon 2000/...		1242cc.	Fire 188.A5 (DOHC) 16V 80HP Ø71	183
250500	Prisma 1983/..., Delta 1986/92		1301cc.	831B 75HP Ø86.4	142
271900	Musa 2004/...		1368cc.	169 A4 75HP Ø72	191
271407	Ypsilon 1995/01		1370cc.	840 A2 80HP Ø82	136
250500	Prisma, Delta 1978/81		1498cc.	80HP Ø86.4	142
250600	Delta, Prisma 1986/...		1498cc.	831B1 80/85HP Ø86.4	144
252207	Delta i.e, Prisma i.e 1986/89, Delta, Prisma 1986/92		1498cc.	831B1 75/80HP - M202 82HP Ø86.4	134
260300	Dedra 1989/93		1581cc.	835A 80/90HP Ø86.4	164
260900	Delta, Dedra, Lybra 1996/...		1581cc.	182A4 103HP - 182A6 90HP16V Ø86.4	170
260100	Delta, Dedra 1993/99		1756cc.	835C 90/105HP - 836A 90/101HP Ø84	162
260400	Prisma 1986/91	DIESEL	1929cc.	831D 65HP Ø82.6	165
270000	Delta, Dedra TD 1994/99	DIESEL	1929cc.	160D 90HP Ø82.6	172
260100	Thema, Delta Turbo 1987/94		1995cc.	831C 177HP - 834B 115HP Ø84	162
471500	Phedra JTD, Zeta JTD 2000/...	DIESEL	1997cc.	DW10JATED4 (RHW) - RHM 110HP Ø85	387
270900	Kappa 1994/01 - 1996/02		1998cc.	838A1 - 838A6 - 182B7 145/155 Ø82	184
271300	Kappa 1994/01		1998cc.	838A1 145HP Ø82	188
461500	Zeta TD 1996/00	DIESEL	2088cc.	P8C 12V 109HP Ø85	373
471500	Phedra JTD 2002/...	DIESEL	2179cc.	DW12TED4 (4HW) 130HP Ø85	387
251807	Kappa TD 1994 - 1995/00	DIESEL	2387cc.	838A3 - 838A7 124HP Ø82	134

MAHINDRA					
930007	Tractor 255DI - 265DI - Pick Up	DIESEL	1300cc.	25HP Ø89.9	XXX
930007	Tractor 255DI - 265DI - Pick Up	DIESEL	1800cc.	25HP Ø89.9	XXX
930007	Tractor 255DI - 265DI - Pick Up	DIESEL	2500cc.	25HP Ø89.9	XXX

MASSEY FERGUSON					
					Ver/See Perkins
					Ver/See International Maxion
MAXION					
MAZDA					

972005	345 22/29		1296cc.	E3 60HP Ø77	
971300	121/323 1992/94		1323cc.	B3 (SOHC) 16V 73HP Ø71	
970300	818 1972/77		1490cc.	NA 100HP Ø78	



MAZDA					
Ref.	Modelo/Model	Cm³	Motor/Engine		
972005	323 1980/87, Familia 1983/84	1490cc.	E5 85HP Ø77		
970300	616/626/808, Capella 1971/77, Capella, Pick Up, 626 1978/..., E1600 1982/84	1586cc.	NA 75HP Ø78		
971400	323, MX-3 1989/94, Familia 1986/89	1597cc.	B6 (SOHC) 8V 84HP Ø78		
971707	323 1986/94, Familia 1987/94	1720cc	PN 55HP Ø78		
971800	626, Capella, E1800 1982/87	1789cc.	F8 90/100HP Ø86		
910100	626TD 1993/97, 323D 1998/...	1998cc.	RF - CX 75/82HP Ø86		
971800	626, Capella, E2000 1982/87, B2000 1985/88 - 1991/96	1998cc.	FE 90/120HP Ø86		
302200	6 2002/....	1999cc.	LF (DOHC) 16V 104HP Ø87.5		223
302400	6 2002/..., 3 2003/...	1999cc.	LF (DOHC) 16V 105/141HP Ø87.5		225
900900	E2200 1984/86, B2200 1985/87	2184cc.	R2 64/71HP Ø86		
302200	6 - MPV 2002/....	2261cc.	L3 (DOHC) 16V 104HP Ø87.5		223
971907	Xedos 9 1993/95, Millenia 1994/00, 626, MX6 1996/98, Xedos, Milenia 1995/...	2497cc.	KL/KLD 165/170HP (DOHC) V6 24V Ø84.5		
971607	MPV TDI 1996/..., B2500 2002/...	2499cc.	WLT - W6 115HP Ø93		
971100	Camión, Pick Up T2500, Autoelevador Yale 1980/...	2522cc.	XA - XB - S5 - WE5 77HP Ø89		
971200	Pick Up, Camión T3000 1985/..., Autoelevador Yale 1984/...	2977cc.	HA - WEF 86HP Ø95		
MERCEDES BENZ					
370008	Clase 140A 1997/...	1397cc.	M166.940 82/102HP Ø80		300
370008	Clase 160A 1997/..., Vaneo 2001/...	1598cc.	M166.961 82/102HP Ø80		300
351408	A170 CDI 1998/01, Vaneo TD 2001/... DIESEL	1689cc.	OM668.940 90HP - OM668.941 91HP Ø90		299
350500	170DA/170DB/170D/170SD/180D/180DB/O 319D/L405/L406 DIESEL	1767cc.	OM 636.916/918/919/931/930/934 40/45HP Ø75		301
370195	C180/C160/C200/CLK200 2002/..., E200 2003/..., C230, SLK200 2004/...	1796cc.	MB271.940/941/946/921 143/122/163/192HP Ø82		312
351700	190E 1990/93	1797cc.	MB102.910/919 108HP		307
351600	L307/200D/N1300, MB90/100, L307/L406D/L408D/0309D/306D/306D6 DIESEL	1988cc.	OM 615 55/60HP Ø87		306
351700	190 1982/84, 190E 1985/93, 200 1984/93	1996cc.	MB102.921/922/962 90/105/122HP Ø89		307
360500	E200D, C200D, 200D/TD 1984/93 DIESEL	1997cc.	MB601.911/912/913 72/75HP Ø87		311
351200	Sprinter 413 CDI 411/413/313/611/981 2000/..., C200-CDI 611.961/960 Vito 108/110/112 CDI, Sprinter 208/211/213 CDI 611.980 DIESEL	2151cc.	OM 611 - CDI 611.960/961 100/125HP 611.980 100/112HP Ø88 Iny. Directa		303
360500	190D 1984/... DIESEL	2197cc.	MB601.921 72HP Ø87		311
360100	240D/TD 1973/..., 207/307/407/507/510D, L406/407DG, 0309D, 240GD 1976/87, MB100/200/300/400/180D/150/170 DIESEL	2404cc.	OM 616.912/934/960/916/940/961/963 65/72HP Ø91	100	310
430000	Sprinter TDI 1997/... DIESEL	2495cc.	95HP Ø90.5		314
352400	E270 CDI, ML270 CDI, CLK270CDI, C270 CDI/G270 CDI, Sprinter CDI DIESEL	2685cc.	OM612.961/962/963/965/967/981 (DOHC) 20V Ø88		309
230700	V280 1998/... DIESEL	2792cc.	MB140.900 174HP Ø81		498
351100	Sprinter T1N 1995/99, 290 TD, E290 GTD 1994/... DIESEL	2874cc.	OM 602.980/982/983 122/129HP Ø89		302
351300	210D/310D/410D/G290/290GD 1992/... DIESEL	2874cc.	MB602.940/942/947 95/98HP Ø89		304
352400	C30 CDI AMG 2002/... DIESEL	2950cc.	OM 612.990 231HP Ø88 (DOHC) 20V		309
351500	300 Turbo 1985/93, E300 Turbo 1993/96, 300GD 1989/93 DIESEL	2996cc.	OM603.931/950/960/963 143HP Ø87		305
351800	300GD, 300GD (4 x 4), 209D/309D/ 409D/240D, 300D/CD/TD 1974/89 DIESEL	2998cc.	OM 617.910/913/931/932 80/88HP Ø91		308
350100	MB L608 D/Unimog 1966/... DIESEL	3786cc.	OM 314 85HP Ø97	84	
350800	711D/811D/609D/614D/709D/809D, OM364 Aspirado 1987/... DIESEL	3971cc.	OM 364 90/115HP Ø97.5	92	
351000	Vario 614/814/815/810 -Atego 712/714/715/717/812/814/815/817/917/1017/1214/1215/1217/1317/1517 DIESEL	4250cc.	OM 904 LA - OM 904 LA IMO Electronico 75/125HP Ø102	95	
350000	MB 3500, L3250/L3500 1949/52 DIESEL	4580cc.	L911 OM311/312 98HP Ø90	83	
350200	MB 1112/1114/0140/L1112/L1514 1957/... DIESEL	5100cc.	OM 321 108HP Ø95	85	
350300	MB 1114, 0140 1972/..., OM 352 Turbinado, OM 352 Aspirado 1981/... DIESEL	5675cc.	OM 352 100HP Ø97	86	
350400	MB 1517 Turbo 0170, L911, L1518 1978/... DIESEL	5675cc.	OM 352A 130HP Ø97	88	
360200	Turbinado Aspirado 1981/... DIESEL	5675cc.	OM352 - OM352A Ø97	101	
352200	MB 1518 desde 1991/... - Motor Híbrido. DIESEL	5765cc.	OM 352 - OM 352A Turbo 130HP Ø97	97	
350900	OH1215/1315/1316/1319/1320/1420/1615, Aspirado Turbo 1620, OHL1621/OS1318, L1915/1314/1318/1365/2018/3611R/2214/2217 DIESEL	5957cc.	OM 366 138HP - OM 366A/LA 170HP Euro Ecológico Ø97.50	93	
352000	Atego I 925/1225/1228/1325/1328/1525/1528/1823/1828/2523 1998/... DIESEL	6370cc.	OM906 LA Electrónico 231/245/279HP Ø102	96	
350600	MB 1521/1526 1985/87 DIESEL	9650cc.	OM 355-5 84HP Ø128	90	
360000	1630/1632/1633, MB485.980, MB489.960/961, MB475.907/950, MB954/976/979/982/984/986/989/991/994/997/998 DIESEL	9973cc.	OM449A/LA - HLA 5 cilindros 180/200HP Ø128	99	



MERCEDES BENZ					
Ref.	Modelo/Model		Cm ³	Motor/Engine	
360400	0371, Bus 1926 1985/...	DIESEL	11580cc.	OM 355-6 230HP Ø128	103
360300	O372/O400/L1395/1939/1941 1973/...	DIESEL	11967cc.	OM 447-6 250/300HP Ø128	102
360800	OM457LA/LAIII/HLA/HLA III, OM457.933/938/940/944/949, O400BUS Camión LS1938, LK/LS/L2638, Axor 2035/40, 2540/44, 2640/44, 3340/44 4140/44	DIESEL	11967cc.	OM457 Electrónico - 252/456PS 355/380HP Ø128	105

MINI COOPER					
981300	One Coupe (Mini R50) 2000/01, Cooper Coupe (Mini R50) 2000/01		1598cc.	W10B16A 90/116HP Ø77	08

MITSUBISHI					
950700	L100, Minicab 1977/83		550cc.	2G 23 28HP Ø70	
950300	Lancer 1977/78		1238cc.	4G36 73HP Ø73	
950300	Lancer, Celeste 1977/..., L300 1980/81		1439cc.	4G33 82/85HP Ø73	
950800	L200, Celeste A144, Lancer A174, Galant A161 1979/81		1597cc.	G32B 86/100HP Ø77	
961500	Lancer, Colt 1992/...		1597cc.	4G92 (SOHC) 16V 113HP Ø81	
951600	Pajero iO 1998/...		1799cc.	4G93 (SOHC) 16V 92HP Ø81	
951600	Eto Carisma 1995/99, Mirage 1997/07, Langer, Pajero iO, Pajero Jr 2001/...		1834cc.	4G93 (SOHC) 16V 113HP Ø81	
961500	Space Wagon 1991/99, Colt, Galant, Lancer, Eterna, Mirage 1992/96		1834cc.	4G93 (SOHC) 16V 120/121HP Ø81	
580900	Carisma TD 1997/...	DIESEL	1870cc.	F8QT 90HP Ø80	439
581608	Space Star TD 2001/..., Carisma 1999/...	DIESEL	1870cc.	F9Q1 - F9Q2 102HP Ø80	400
950600	Sapporo, Super Touring, Super Saloon, Galant L200/L300 1980/93		1997cc.	G63B 100/110HP Ø85	
910500	Canter, L200, L300, Montero, Pajero 1982/86	DIESEL	2346cc.	4D55T 67/84HP Ø91	
910500	L 200 1987/..., Canter T35 1987/98, Pajero, Montero 1986/...	DIESEL	2476cc.	4D56/T 70/75/84HP Ø91	
910700	L200, Pajero, Montero, Nativa 2001/...	DIESEL	2476cc.	4D56T 115HP Ø91 (SOHC) 8V	
970400	Nativa TD 1999/..., Montero, Pajero, Shogun TDI 1995/...	DIESEL	2835cc.	4M40TD 125HP Ø95	
960000	Montero Sport, Pajero, Soghun 1995/99		2972cc.	6G72 (SOHC) V6 24V 178HP Ø91.1	
960807	Galant, Debonair, Montero, Shogun, Pajero, Pick Up		2972cc.	6G72 V6 24V 141/150/177HP Ø91.1	
961000	Montero Sport, Pajero Sport 1995/99, Soghun 1995/99		2972cc.	6G72 (SOHC) V6 24V 203HP Ø91.1	
920600	Canter, Rosa Bus 1978/...	DIESEL	3298cc.	4D 30 90HP Ø100	
961100	Montero, Debonair 1993/..., Shogun, Pajero 1994/...		3497cc.	6G74DN (DOHC) V6 24V 215/260HP Ø93	
961200	Montero Sport, Pajero Sport 1997/...		3497cc.	6G74 (SOHC) V6 24V 203/245HP Ø93	

MWM					
320800	Tractor 65ID, Valmet 62ID 1970/76	DIESEL	2550cc.	D225-3 50HP Ø95	112
330500	Agrale TD, Micro/Buses 2000/...	DIESEL	2796cc.	MWM 4.07 CA 131HP Ø93	319
331100	Blazer, S10 2000/..., LT TDI Electronico 2002/06	DIESEL	2796cc.	Sprinter 4,07 TCA Commom Rail 132HP Ø93	321
330800	Camión TX 1600 1983/... - Autoelevador, E300, Tractor 68 1983/...	DIESEL	2942cc.	D229-3 72HP Ø102	116
440000	850E	DIESEL	2977cc.	D225-4 68HP Ø95	119
440000	Tractor 85ID 1970/76	DIESEL	3400cc.	D225-4 68HP Ø95	119
310400	F1000/F4000 1992/96, F2000, FB4000 1980/..., Escavadora FB80	DIESEL	3922cc.	D229-4 96HP Ø102	107 317
320400	Tractor 86-ID, Camión F4000 1986/..., Tractor 85 1986/...	DIESEL	4156cc.	D226-4 82HP Ø105	111
330600	GM Silverado 3500HD, Grand Blazer, F100 GMC Turbo 1997/...	DIESEL	4200cc.	Sprinter 6.07 TD 167HP Turbo Intercooler 198HP Ø93	320
330400	7000/7500/8500 - Euro I/II/III - 7100/8120/8140/8150/13150	DIESEL	4300cc.	4.10 X10 90HP - 4.10T/TCA 133/167HP Ø103	113
331200	Agrale 8500/9200, Constelation 13.180E/15.180E	DIESEL	4800cc.	4.12TCE Commom Rail 150/180HP Ø105	117
440100	Camión 1978/... - Tractor AD7B, 980E, S90 - Tractor 110 ID	DIESEL	5100cc.	D225-6 102HP Ø95	120
310500	F14000/F4000/F12000, Cargo- Tractor S90, FE105, FA120, FE105B	DIESEL	5883cc.	D229-6 145HP Turbo 160HP Ø102	109
330700	13180/15180/16210 - F14000 1995/98, Euro I/II	DIESEL	6450cc.	6.10 X10 139HP - 6.10T/6.10TCA 201/250HP Ø103	114
331300	26.260E/31.260E/17.260EOT/17.210EOD, VM210/260/310	DIESEL	7118cc.	6.12 TCE 210/260/310HP Common Rail Ø105	118

NISSAN					
903207	March 1982/..., Micra 1988/...		988cc.	MA10 55HP Ø68	
903207	March, Micra 1986/...		1235cc.	MA12 60HP Ø71	
902600	Datsun Sedan, Estaquitas, Guayin, Pick Up 1970/84		1483cc.	J15 77HP Ø78	
920000	Samuray, Sedan, Ninja, Guayin 1984/94		1487cc.	E15 Ø76	
470300	Micra 1997/...	DIESEL	1527cc.	TUD5 (VJZ) 58HP Ø77	376
902600	Datsun Sedan, Estaquitas, Guayin, Pick Up 1970/84		1567cc.	J16 80HP Ø78	
901007	510 1968/73 - 521 1969/72		1597cc.	L16 100HP Ø83	
902100	Sentra 1991/94, Tsubame, Tsuru, Vanette Cargo 1993/97		1597cc.	GA16DE/DNE (DOHC) 16V 97/105HP Ø76	
902900	Tsuru, Sentra 1997/06		1597cc.	GA16DNE (DOHC) 16V FI 97HP Ø76	



NISSAN					
Ref.	Modelo/Model	Cm³	Motor/Engine		
920000	Sentra, Tsuro 1984/94	1597cc.	E16 Ø76		
903007	Sunny 1986/89, Pulsar 1987/...	1598cc.	CA16DE 122HP Ø78		
902407	Sentra 1983/87, Pulsar 1986/..., Cherry, Sunny 1982/89	DIESEL 1680cc.	CD 17 54/61HP Ø80		
901007	skyline - violet - silvia 1976/81	1770cc.	L18/18S 105HP 85		
903400	Tiida 2007/08	1797cc	MR18DE (DOHC) 16V 124HP Ø84		
902200	Pick Up, Sacura, Estaquitas, Ichi Van 1981/93, Samurai Guayin 1982/84	1800cc.	J18 Ø80.5		
903007	200 SX Turbo 1989/93, Sunny Turbo 1988/..., Sunny, Pulsar 1988/...	1809cc.	CA18DET Turbo 169HP - CA18DE 125HP Ø83		
581608	Interstar, Primera, Primastar 2002/...	DIESEL 1870cc.	F9Q - F9Q772/774/760/762 82/100/120HP Ø80		
900000	Bluebird, Vanette 1980/84	DIESEL 1952cc.	LD20 60HP Ø85		
901007	Violet - 200SX 1976/80	1952cc.	L20B 105HP Ø85		
900600	Cedric, Junior, Caball, Clipper, Cabstar, Forklift 1965/82, Caravan	1982cc.	H20 92HP Ø87.2		
903500	X-Trail 2001/..., Primera 2002/...	1998cc	QR20DE 150HP (DOHC) 16V Ø89		
903107	NX 2000, Tsuru, Sentra, Serena, 200 SX 1991/96, Primera 1990/93 Sunny GTI Turbo 1990/94, Almera, Sentra 1995/00	1998cc.	SR20DE 125/140/143/150HP - SR20DI 115/121HP SR20DET 220HP Ø86		
900305	Cabstar, Homer 1982/..., Urvan 1984/88	DIESEL 2289cc.	D23 68HP Ø84		
902300	Vanette, Pathfinder, Chocolate 1987/...	2389cc.	Z24I (SOHC) 103HP Ø89		
902500	Ichi Van 1991/94, Pick Up, Terrano II, Van 1989/...	2389cc.	KA24E - KA24S 124/133HP Ø89		
903600	Urvan, Urvan 2000/03, King-Cab 2001/..., X-Terra, Frontier, Altima 2000/01	2389cc.	KA24DE 139/150HP Ø89 (DOHC) 16V		
581800	Primastar 2002/...	DIESEL 2484cc.	G9U-730 90HP Ø87	445	
903500	X-Trail, Altima, Sentra 2002/..., Maxima 2004/...	2488cc.	QR25DE (DOHC) 16V 165/177HP Ø89		
904000	King-Cab TD 2001/..., Hardbody 2006/...	DIESEL 2488cc.	YD25DDTI 133HP Ø89		
900305	Cabstar, Homer 1968/72, Pick Up 720 1984/89	DIESEL 2488cc.	SD25 68/72HP Ø84		
581800	Interstar 2002/...	DIESEL 2499cc.	G9U-720/724/750/754 90HP Ø87	445	
920200	Pathfinder D, Terrano D 1986/..., Terrano TD 1989/92	DIESEL 2663cc.	TD27 - TD27T 85/100HP Ø96		
900100	Laurel, Cedric, Maxime, 810, 280C 1980/...	DIESEL 2793cc.	LD28 84HP Ø84.5		
330500	Frontier - X Terra 2003/06, X Terra Electrónico 2007/...	DIESEL 2796cc.	Sprinter 4.07 CA 132HP Ø93	319	
331100	Frontier Xterra electronico 2007/...	DIESEL 2796cc.	VW28TI 132HP Ø93	321	
900500	Pick Up, Eco T100, Cabstar 1973/...	DIESEL 2956cc.	ED30 76HP Ø109		
901300	Pathfinder, Terrano 1987/95, Quest, Maxima 1990/98	2960cc.	V30E - VG30E (SOHC) V6 12V 148/170HP Ø87		
901400	Máxima Q x 4 1997/..., Pathfinder 1996/..., Frontier 1998/...	3274cc.	VG33E (SOHC) V6 12V 168/170HP Ø87		
900500	Pick Up, Eco T100, Cabstar 1973/...	DIESEL 3298cc.	ED33 84HP Ø109		
901500	Pathfinder, Cefiro, Qx4 2000/01	3498cc.	VQ35DE (DOHC) V6 24V 220HP Ø95.5		

OPEL Ver/See GM Chevrolet

PERKINS - MASSEY FERGUSON					
420600	Rover, Maestro D/TD, Perkins, Marino 4.20 D/TD, Leyland Sherpa 185/200/215/220/230/240/255 1986/94, Daf Ka 200/VS 200 1986/...	DIESEL 1994cc.	Prima 65/80T - Leyland Prima 65 Daf TN 44 64/80HP Ø84.45	150	327
420400	MF50/50X/55X/135/200/235/250, MF 135/515	DIESEL 2360cc.	3.152 42HP Ø89	149	
400500	Tractor Viñatero	DIESEL 2362cc.	P3 - 152 42HP Ø91.44	126	
422000	MF133/135/148/230/235/240/254/353, Industrial MF40, Agrícola/Marino	DIESEL 2500cc.	D3.152-D3.152/2 - G3.152-D3.152/4 100HP Ø91.40	151	
410200	MF50 Tractor, MF50X/55X, MF135/200/235/250	DIESEL 2502cc.	P3 - 152 42HP Ø91.44	138	
420400	MF50/50X/55X/135/200/235/250, MF 135/515	DIESEL 2502cc.	3.152 42HP Ø91.44	149	
423000	Case-IH CS 68/75	DIESEL 3300cc.	320D	01	
410500	Tractor MF65X, MF40B/65/155/158/165/260/155/164C, CBC1000	DIESEL 3330cc.	D4.203/AD4.203 Iny. Directa 71HP Ø91.4	141	
410800	Pick Up, Camiones livianos	DIESEL 3330cc.	T 4.33 Turbo Iny. Directa 91/95HP Ø91.46	144	326
400000	D100/D200 1987/... - F100, Falcon 1970/...	DIESEL 3336cc.	4.203-P4-192Z 71HP Ø91.49	121	322
400700	Tractor M165, 265	DIESEL 3336cc.	MF165 - 265 71HP Ø91.49	81	
410000	F100	DIESEL 3336cc.	4.203 Potenciado 71HP Ø91.44	136	324
410300	Potenciado	DIESEL 3336cc.	MF265 Potenciado 71HP Ø91.44	139	
420100	Tractor 8 BR	DIESEL 3336cc.	4.203 - 8 BR Iny. Indirecta 71HP Ø91.49	147	
401000	Vehicular GM D20	DIESEL 3860cc.	Q20B4 Iny. Directa 70HP Ø98.4	129	323
410600	GM D10, F350, VW6.80, Case 550, GM D10/20/40 Aspirado Turbo	DIESEL 3860cc.	4.236 Iny. Directa 70HP Ø98.4	142	325
420200	Case 580H	DIESEL 3860cc.	4.236 Iny. Directa 70HP Ø98.4	148	
401500	Phaser 90/110T/120 Ti, 4.40, T4.40, C4.40, MF6130/6140/6150	DIESEL 3993cc.	1004.4/T/TW Ø100	131	
410600	MF220, F290, Tractor MF85X	DIESEL 4070cc.	4.248 70HP Ø101	142	325



PERKINS - MASSEY FERGUSON

Ref.	Modelo/Model		Cm ³	Motor/Engine		
410700	Case 580H, MF85, MF270/275/285/290, MF220/220A, Hyster H110	DIESEL	4070cc.	A4 - 248 75HP Ø100		143
420200	Case 580H	DIESEL	4070cc.	4.248 Iny. Directa 100HP Ø100		148
401100	MF290/292/610/620	DIESEL	4100cc.	P4000-4000T 72/86HP Ø100		130
320400	Tractor 85 1986/...	DIESEL	4156cc.	D226-4 82HP Ø105		111
423100	MF4292, MF4297	DIESEL	4400cc.	420DS Agco Sisu Power 110/117/120/129HP Ø108		02
400100	DP 400/500 1964/... - F350/600	DIESEL	5004cc.	6.305 Cadenero 100HP Ø91.44		122
400300	F100/F350/600 1974/...	DIESEL	5004cc.	6PF - 305 102HP Ø91.44		124
400600	Tractor - PF	DIESEL	5004cc.	6PF - MF1175 100HP Ø91.44		127
410100	F600	DIESEL	5004cc.	6PF - 305 Potenciado 100HP Ø91.49		137
400200	DP 600/800 1968/... - F600/700	DIESEL	5798cc.	6.354-2 140HP Ø98.47		123
400400	D600/800 1976/... - F7000 Camiones - Ford pesados y semi-pesados	DIESEL	5798cc.	6.354-4 Turbo 172HP Ø98.42		125
400800	Tractor 1095/1098/1195/1215	DIESEL	5798cc.	6.354-2 140HP Ø98.3		82
400900	DP 600/800 - F600/700	DIESEL	5798cc.	6.354-1 135HP Ø98.43		128
401700	1095/1098/1195/1215 1970/..., Tractor, Estanciera, Grúa, Rodantes	DIESEL	5798cc.	6.354-2 Turbo Ø98.47		134
410400	Tractor 1215/1218	DIESEL	5798cc.	T6.354-4 172HP Ø98.63		140
410900	P700D/ P900 - F600/750/1100, MF3366, F6000/F7500/F11000	DIESEL	5840cc.	6-357 Veh. 120HP - Agr. 91HP - Ind. 108HP Ø104.14		145
420000	MF 400C	DIESEL	5840cc.	6-358 Veh. 133HP - Agr. 118HP - Ind. 127HP Ø104.14		146
401600	Phaser 125, MF396/399/630/640/3085/6160/6170 - Phaser 160Ti, MF660/3114/3125/3625/3635/3655/6189/6190/8110/8120/8130 - Phaser 180Ti	DIESEL	5985cc.	1006.6/C/T/TW Ø100		132
423200	Case-IH CS/CVX 120, 130, 150 - CVX 1135,1145,1155,1170,1190		6600cc.	620D		03
420508	D170 - P 200/260/270/320 - MF RX 100T		8850cc.	510 -540 V8 Ø108 170/183HP		XXXIII

PEUGEOT

451500	205 1987/93, 106 1991/...		954cc.	TU9M/MZ/K 41/45/50HP Ø70		355
451800	104 1972/86, 205 1983/86		954cc.	XV3 - XV5 - XV8 45HP Ø70		366
460500	104, 205 1986/87		954cc.	XV8 45HP Ø70		366
581000	206 2000/...		999cc.	D4D 70HP Ø69		440
451800	104 1975/86, 205 1983/86		1124cc.	XW3 - XW7 57HP Ø72		366
451500	106, 306, Partner 1996/...		1124cc.	TU1M 54HP Ø72		355
451700	106 1991/..., 306 1993/97, 205 1987/96, 309 1990/93		1124cc.	TU1K/KZ/M 55/60HP Ø72		357
460500	205 1986/87, 104 1986/...		1124cc.	XW7 55/57hp Ø72		366
460700	106 1991/..., 306 1993/97, 205 1987/96, 309 1990/93		1124cc.	TU1M/K/Z 55/60HP		368
451800	104 1980/84		1219cc.	XZ5 57HP Ø75		366
450900	403/7 1959/66		1290cc.	7CV 52HP Ø75		352
460700	205 Rallye 1988/93		1294cc.	TU24 102HP Ø75		368
451600	106 1991/96, 309 1992/93, 405 1993/94, 205 1991/93		1360cc.	TU3F2 - TU3FM - TU3J2/Z - TU3MC 75/94HP Ø75		356
451700	106 1991/..., 206 1998/..., 306 1993/..., 405/205/309 1987/96, Partner 1996/...		1360cc.	TU3A/S/K/M/JP/MC 65/70/75/80HP Ø75		357
451800	104 1982/86, 205 1983/86		1360cc.	XY6B/XY8 - XY6B/XY7 70HP Ø75		366
452200	206, 307 2001/..., Partner 2005/..., 207 Compact		1360cc.	TU3JP (KFW/K6D) 75HP Ø75		361
460500	205 1986/87		1360cc.	XY6B - XY7/XY8 70HP Ø75		366
460700	Partner 1996/..., 306 1993/..., 106 1991/..., 205, 405 1987/96, 309/206 1998/...		1360cc.	TU3JP/S/M/MC/K/A - TU3.2 65/70/75/80HP Ø75		368
470400	106 1992/95	DIESEL	1360cc.	TUD3 50HP Ø75		377
471700	207, 207 SW, 308, 308 SW 2007/...		1397cc.	EP3 (8FS) - EP3 (DOHC) 16V 95HP Ø77		388
302100	206 TDI, 307 HDI 2001/...	DIESEL	1398cc.	DV4TD (8HZ/8HX) 68HP (SOHC) Ø74		222
471300	207 Compact	DIESEL	1398cc.	DV6TED4 70HP (DOHC) 16V Ø75		385
450900	403/8 1955/67		1468cc.	8CV 55/58 Ø80		352
470300	106 1994/...	DIESEL	1527cc.	TUD5 (VJZ) 55/58HP Ø77		376
471300	307 HDI, 407 TD 2004/...	DIESEL	1560cc.	DV6TED4 - DV6TED4(9HZ) 108HP (DOHC) 16V Ø75		385
451295	305 1982/91, 205 1984/96, 309 1985/93, 405 1987/95		1580cc.	XU5 75/90/92/115HP Ø83		353
452100	206, 307, Partner 2000/..., 207 SW, 207 Compact		1587cc.	TU5JP4 (NFU/N6A) 16V 109HP Ø78.5		360
470500	106 1994/..., 306 1993/..., 206 1998/...		1587cc.	TU5JP/J2 90/103HP Ø78.5		378
471700	207/207SW, 308/308SW 2007/..., Partner 2008/..., 3008, 5008 2009/...		1598cc.	EP6 (5FW) - EP6C (5F01) (DOHC) 16V 120HP Ø77		388
471800	207/207CC, 308/308SW 2007/..., 3008 2009/..., 508/508SW, 5008, RCZ 2010/...		1598cc.	EP6DT/CDT/DTS 150/156/163HP Ø77		389
450000	404 1962/80		1618cc.	XC7-XC7P 59HP Ø84		338
450100	504 GLS/GLSE 1969/80		1657cc.	XC7-XC6A 59HP Ø85		340



PEUGEOT					
Ref.	Modelo/Model		Cm³	Motor/Engine	
460100	306 1993/..., 405, 406 1992/..., 406 1997/...		1761cc.	XU7JP-XU7JB 90/103HP Ø83	362
460800	306 1997/..., 406 1995/96, 406 1997/...		1761cc.	XU7JP4 (DOHC) 16V 112HP Ø83	369
461100	Partner 1997/...		1761cc.	XU7JB 90HP Ø83	371
470700	205 TD 1990/96, 405 TD 1988/94, 309 TD 1990/93	DIESEL	1769cc.	XUD7T/TE 78/90HP Ø80	380
470900	205/309 1983/96, 306 1993/..., Partner 1996/...	DIESEL	1769cc.	XUD7 60HP Ø80	382
450200	504, XE, XL, XSE 1973/78		1796cc.	XC7 - XM7 69/70HP Ø85	341
470600	206, 306 1998/..., Expert, Partner 1999/...	DIESEL	1868cc.	DW8 (WJZ/WJY) 71HP Ø82.2	379
451295	205, 309 1986/94, 305 1983/91, 405 1987/93		1905cc.	XU9J1/J2 100/110/125/130HP Ø83	353
451407	309 1989/93, 405 1987/95		1905cc.	XU9J4 147/155/160HP Ø83	329
460200	306, 405, 309GT, 305GTX 1986/93		1905cc.	XU92C 98/102HP Ø83	363
460300	306/405/305/309 1982/..., 205, Express, Boxer, Expert, Partner 1987/...	DIESEL	1905cc.	XUD9 64/69/71/90HP Ø83	364
460900	306/405/406 TD 1992/99, 806TD, Expert TD, Boxer TD 1995/...	DIESEL	1905cc.	XUD9TE/SD/TF/UTF 90/92HP Ø83	370
461307	306, 405, Boxer, Partner, Expert 1995/...	DIESEL	1905cc.	XUD9 65/69HP Ø83	331
500200	404, T4B, T5B, Rastrojero 1972/...	DIESEL	1948cc.	XD/XDP 4.88 50/59HP Ø88	391
450300	504, TN, GES, XNA 1976/80		1971cc.	XN1 -XN2 78/85HP Ø88	343
450500	505, 9R, J9/J5 1980/92		1971cc.	GR/SR - XN1/XN2 85HP Ø88	347
450600	505 1983/86, 504 1970/84, 604 1982/86		1971cc.	XN2 - XN6 105HP Ø88	349
450800	505 1987/...		1971cc.	XN1 - XNA - Gamma 90HP Ø88	350
461200	505 Inyección ZEJ 1979/...		1995cc.	ZEJ 110HP Ø88	372
470800	306/406/206/806HDI, Expert, Partner HDI 1998/..., 307/607 2000/...	DIESEL	1997cc.	DW10TD/ATED 90/110HP Ø85	381
471200	206/307/406/806/807, Expert 2000/..., 406 HPI, 607 2001/..., 407 2004/...		1997cc.	EW10J4 (RFN-RLZ) 16V 136/140HP Ø85	384
471400	307 HDI FAP, 407 HDI 2003/..., Expert HDI 2007/..., 807 HDI 2006/...	DIESEL	1997cc.	DW10BTED4 (RHR/RHK) 136HP Ø85 (DOHC) 16V	386
471500	806 HDI, Expert HDI 1999/..., 807 HDI 2000/...	DIESEL	1997cc.	DW10ATED4 (RHW/RHT) 109HP Ø85	387
471900	308/407 HDI - 308/407 SW HDI 2007/... - 308 CC HDI - 407 Coupe HDI 3008/5008 HDI - Expert Tepee - Expert 3 2009/... - RCZ HDI 2010/...	DIESEL	1997cc.	DW10CTED4 (RH02/RHH) (DOHC) 16V 150/163HP Ø85	390
451395	605 1989/98		1998cc.	XU10M/2C/J2 107/114/122/130HP Ø86	354
451995	405 1992/..., 306 1993/...		1998cc.	XU10J2C(RFX) 123HP Ø86	358
460400	406, 605, 806 Turbo 1996/...		1998cc.	XU10 J2TE 150HP Ø86	365
460600	405 1992/..., 306 1993/...		1998cc.	XU10J2C 123HP Ø86	367
470200	405 MI, 405 TI Turbo 1992/95, 306 1993/...		1998cc.	XU10J4 152/155HP - XU10J4TE 200HP Ø86	375
471000	406, 605 1995/..., 306 1997/..., 806 1998/01		1998cc.	XU10J4R - XU10J4R (RFV) 16V 132/135HP Ø86	383
461500	605 TD 1990/98 - 1995/98, 406 TD 1995/..., 806 TD 1996/...	DIESEL	2088cc.	XUD11ATE/BTE 12V 110HP Ø85	373
500600	504 1980/..., J7/J9 1980/87, Adaptables Pick Up	DIESEL	2112cc.	XD-XDP 4.90 59HP Ø90	394
461200	505 GTI ZDJ 1982/91		2165cc.	ZDJ 123HP Ø88	372
471500	607 HDI, 406 HDI 2000/..., 807 HDI 2002/...	DIESEL	2179cc.	DW12TED4 (4HX) 133HP Ø85	387
324800	Boxer HDI 2006/...	DIESEL	2198cc.	4HU/4HV (P22DTE) 101/120HP Ø86	282
450400	504D 1976/93, 505D/TD, 604TD 1978/83, J7D1977/..., J9D 1980/...	DIESEL	2304cc.	XD2 - XD2P 70/73HP Ø94	345
452000	Boxer TDI 1997/...	DIESEL	2445cc.	DJ5TED(THX) 107HP Ø92	359
470000	Boxer D/TD 1994/..., 605 TD 1995/99	DIESEL	2445cc.	DJ5/DJ5T/DK5ATE 86/103/130HP Ø92	374
471108	Boxer TDI 1997/...	DIESEL	2445cc.	DJ5TED (THX) 107HP Ø92	332
450400	XD3 504 1987/..., 505 1982/93, J9 1986/94	DIESEL	2498cc.	XD3 - X3DP 76/90HP Ø94	345
252900	Boxer TDI/HDI 2001/09	DIESEL	2798cc.	8140.43 Euro II - 8140.43S Euro III 122/125HP Ø94.4	159
500300	Pick Up, Camiones Livianos 1976/...	DIESEL	3168cc.	XDP 6.90 95HP Ø90	393
RASTROJERO					
500000	Pick Up, NP6 1955/66	DIESEL	1758cc.	Borgward D4M 42HP Ø78	395
500100	Pick Up, Kombi, Frontal, NC62/NP66, P63/P64, C66/P67 1964/71	DIESEL	1797cc.	Borgward D301 - E1D 52HP Ø78	396
500200	404, T4B, T5B, Rastrojero 1972/...	DIESEL	1948cc.	XD/XDP 4.88 50/59HP Ø88	391
RENAULT					
550000	Gordini, Floride, Dauphine 4L - 4F 1960/64		845cc.	670-04/05 Ø58	407
560300	R5 1973/84		845cc.	839.01 - 800.10 39HP Ø58	417
580295	Express, Super Cinco 1985/93		956cc.	C1C 700/706 41HP Ø65	434
581000	Clio 2000/... - Kangoo 2003/...		999cc.	D4D 68/70HP Ø69	440
580295	R9, R11 1981/89, Super Cinco 1985/93, Clio, Express 1990/93		1108cc.	C1E 688/752/756 45/49HP Ø70	434
581700	Clio II 2005/..., Twingo 2004/...		1149cc.	D4F 708/728 75HP Ø69	444



RENAULT

Ref.	Modelo/Model	Cm ³	Motor/Engine		
570500	Twingo 1996/..., Clio 1995/..., Kangoo 1997/..., D7D, Twingo 2001/...	1149cc.	D7F - D7D 734 /730/700/710/7110 55/60HPØ69		428
581000	Clio II, Kangoo .../00, Twingo, Clio II, Kangoo 2001/...	1149cc.	D4D 700/712/720 - D4F 702/706/712 75HP Ø69		440
560800	E5F/E7F Clio, R19 1990/98	1171cc.	E5F/E7F 55/60HP Ø75.8		422
570000	Twingo, Clio, Express 1992/...	1239cc.	C3G 55HP Ø74		423
550400	R12/R4L/4S/R6/R4 1970/..., R12TS/R15 1972/75	1289cc.	688.01/10-810.88 54HP Ø73		408
580595	R12/R12TS 1969/75, R12/R15/R5 1974/84, Rodeo 1980/81, Estafette 1974/81	1289cc.	810.02/05/09 54/63HP Ø73		436
580695	Super Cinco, R11, R9 Turbo 1984/93	1289cc.	C1J 782/788/760/764 57HP Ø76		437
560800	E6J/E7J Clio, R19, Express 1990/95, Kangoo 2001/..., Megane 1995/97	1390cc.	E6J/E7J Energy 77/80HPØ75.8		422
570900	K4J - Clio II 2001/..., Scenic 1999/..., Megane II 2003/...	1390cc.	K4J 16V 95/98HP Ø79.5		430
571000	Sandero 2008/..., Logan 2004/...	1390cc.	K7J 710/714 75HP Ø79.5		431
550500	R12TS/R5TX 1976/80	1397cc.	847 63/68HP Ø76		409
550700	R9 1981/89, R11 1983/89, R19/R21 1988/93, Super Cinco 1985/93	1397cc.	C1J - C2J 60/67HP Turbo 104/110HP Ø76		411
550800	R12/R18, Junior, Trafic 1982/...	1397cc.	847 48HP Ø76		412
581200	Clio II DCI 2001/... Series 700/702/704/710, Kangoo DCI 2001/... DIESEL Series 700/702, Megane DCI 2002/... Series 722/728/729/704/710, Symbol	1461cc.	K9K DCI (SOHC) 8V 65/80/82HP Ø76		441
581300	Megane II, Sandero Stepway DCI, Symbol DCI, Logan 2006/... DIESEL	1461cc.	K9K DCI (SOHC) 8V 68/100HP Ø76		442
550900	R9/R11/R12/R18/R19 1988/...	1565cc.	C1L - C2L Carburador Ø77		413
580700	Express 1987/96, Super Cinco 1988/96, R9, R11 1988/89 DIESEL	1595cc.	F8M 720/730/736/760 Iny. Indirecta 55HP Ø78		438
560500	R19, Clio, Express 1996/98	1597cc.	C3L Inyección 74HP Ø76		419
570200	Megane Scenic RN, Clio 1998/..., Clio II 1998/05, Sandero 2007/..., Symbol	1598cc.	K7M - 744 75/90/95HP Ø79.5		425
570900	Clio, Scenic, Megane, Laguna 1998/00, Logan 2007/..., Fluence, Duster, Symbol	1598cc.	K4M 16V 106/110HP Ø79.5		430
580807	Trafic, Fuego, R18 1978/... - Fuego 1980/95 - R12/15/16/17/18/20 1972/...	1647cc.	841.705 - 843.105/10/15/23 79/92HP Ø79		399
560100	R19 1989/95, R11 1986/89, Clio 1990/93, R21, Trafic, Super Cinco 1986/94	1721cc.	F2N - F3N 75/92HP Ø81		415
570100	Clio 1991/97, R19 1989/96	1764cc.	F7P 700/704/720/722 16V 133/135/137/140HP Ø82		424
580495	Clio 1991/97, R19 1989/96	1764cc.	F7P 700/704 133/137HP - 720/722 135/140HP Ø82		435
580000	Laguna 1998/..., Laguna, Scenic, Megane, Kangoo 2001/...	1783cc.	F4P 16V (DOHC) 120HP Ø82.7		432
560400	R19, Clio, Laguna 1991/98	1794cc.	F3P Inyección 90/96HP Ø82.7		418
560600	R9, Express, Clio, Kangoo, Trafic, Scenic, Megane DIESEL	1870cc.	F8Q 65HP Ø80		420
560700	R9, Express, Clio, Kangoo, Trafic, Scenic, Megane DIESEL	1870cc.	F8Q (con cárter de aluminio) 65HP Ø80		421
570300	Megane DTI, RN, RT, Laguna 716/730/734/750, Scenic 736, DIESEL Espace 722 1999/..., Kangoo 2000/..., Megane Coupe DTI 731 2000/...	1870cc.	F9Q Turbo (SOHC) Inyec. directa 80/100HP Ø80		426
580100	Clio II 630/632/662, Kangoo 630/632/662 1998/..., Megane 1997/... DIESEL Express 644/648 1997/..., Scenic 1999/..., Rodeo Trafic 600/606 1998/...	1870cc.	F8Q Iny. Indirecta 65HP Ø80		433
580900	R19 DT 1991/96, Megane DT 1996/97, Scenic DT 19986/... DIESEL	1870cc.	F8Q 740/741/768/784/786 90/93HP Ø80		439
581608	Laguna DCI, Trafic DTI, Kangoo, Master II DTI, Megane Cabriolet DTI, DIESEL Avatime, Espace DTI	1870cc.	F9Q-782/790/820 - F9Q-731/732/733 F9Q-722/736/760 - F9Q-762 80/110HP Ø80		400
570600	Laguna N7Q/700/704 1994/99, Safrane N7Q/710/711 1996/99, Space N7Q 1996/...	1948cc.	N7Q 16V 138/140HP Ø83		429
550600	Master, R18, Fuego, Trafic, R21/R25 1981/94, Espace 1984/97, R20 1977/84	1995cc.	829 - J5R/J6R/J7R 80/105/110/116/120HP Ø88		410
582300	Espace IV 2006/..., Laguna II .../2005, Megane II 2006/10, Koleos DIESEL	1995cc.	M9R 700/740 (DOHC) 16V 150HP Ø84		448
570100	Clio, Clio Williams 1993/..., Megane Coupe 1995/99, Spider Sport 1993/...	1998cc.	F7R 700/710/714 147/150HP Ø82		424
570400	Megane RT, Scenic, Laguna RT, RXE	1998cc.	F3R 722/796/729 115HP Ø82.7		427
580000	Megane - Scenic - Espace - Grand Espace - Laguna - Master - Trafic 1999/... Clio II Sport 2001/... - Duster 2011/...	1998cc.	F4R 16V (DOHC) 140/169HP Ø82.7		432
582200	Fluence, Megan III 2001/...	1998cc.	M4R 714 (DOHC) 16V Ø84		447
560000	R18 1981/86, R21 1984/97, Trafic, Master 1981/97 DIESEL	2068cc.	121 80HP Ø86		414
550600	R25 1984/92, R18/R21, Espace 1985/..., Trafic, Master 1989/..., Fuego	2165cc.	851 - J7T 95/107/115/120HP Ø88		410
581400	Laguna D 706/790, Laguna TD 752/792/794/760/740 1996/... DIESEL	2188cc.	G8T D/TD 12V 85/115HP Ø87		443
581507	Laguna 1996/98 DIESEL	2188cc.	GT8 752/792 12V 85HP Ø87		400
251495	B90 1986/88 DIESEL	2445cc.	8140.21 92HP Ø93		151
270807	Master 1981/88 DIESEL	2445cc.	S8U 730/731 52hp Ø93		136
581800	Master 2001/..., Trafic 2003/... DIESEL	2463cc.	G9U-720/724/730/750/754 115HP Ø87		445
582100	Koleos 4x2/4x4 DIESEL	2488cc.	2TR (DOHC) 16V 170HP Ø89		446
270400	Master 1990/... - 1998/... , Trafic 1990/... DIESEL	2499cc.	S8U 742/748/770/772/758/780/782 55/75/80HP Ø93		179
252900	Jumper HDI 2001/09 DIESEL	2798cc.	8140.43 Euro II - 8140.43S Euro III 122/125HP Ø94.4		159



RENAULT					
Ref.	Modelo/Model		Cm³	Motor/Engine	
270300	Master TD 1998/...	DIESEL	2799cc.	S9W 700/702 115HP Ø94.4	177
581107	Laguna, Safrane, Espace 1992/98		2963cc.	Z7X 167/170HP V6 Ø93	400
ROVER					
860000	Metro, 111 1990/94, 111 1995/98		1120cc.	11K8 - 8V 60HP Ø75	451
860000	Metro, 114/214 1990/94 - 1995/99		1396cc.	14K8 - 8V 75HP Ø75	451
860100	214/414 1995/99, 25, 45 1999/...		1396cc.	14K16 (DOHC) 16V 103HP Ø75	452
470300	115TD 1995/98	DIESEL	1527cc.	TUD5 (VJZ) 58HP Ø77	376
860100	216/416 1996/99, 25, 45 1999/...		1589cc.	K16 (DOHC) 16V 111HP Ø80	452
860300	216/416 1989/92		1590cc.	D16A7 (SOHC) 16V 116HP Ø75	
860400	216/416 1992/94		1590cc.	D16A6 111HP Ø75	
470700	218 TD, 418 TD 1991/96, Tourer TD 1996/...	DIESEL	1769cc.	XUD77/TE 88HP Ø80	380
860100	200 Vi 218 Coupe 1995/...		1796cc.	18K16 (DOHC) 16V 120/145HP Ø80	452
860800	618 1996/99		1850cc.	F18A3 (SOHC) 16V 115HP Ø85	
460300	218, 418 1991/96	DIESEL	1905cc.	XUD9A 67HP Ø83	364
860200	Freelander TCIE 1997/00, 620, 420/220/TD 1995/99, 25/45TD 1999/...	DIESEL	1994cc.	20T 97HP - 20T2N 105HP Ø84.5	
890600	820, 820i, 820Si 16V Inyección Multipunto 1986/90		1994cc.	20HD - M16 (DOHC) 16V 103/120HP Ø84.45	453
860800	620, 620 SI 1993/97		1997cc.	F20Z1 131HP - F20Z2 (SOHC) 115HP 16V Ø85	
861000	623 1993/97		2259cc.	H23A3 (DOHC) 16V 158HP Ø87	
500400	Range Rover TD 1986/89	DIESEL	2393cc.	VM492HT 113HP Ø92	455
430000	Range Rover TDI, Discovery TDI, Defender TDI 1990/94 - 1994/98	DIESEL	2495cc.	200/300 TDI 112HP Ø90.5	314
981200	Range Rover Turbo 1994/02	DIESEL	2498cc.	D256TM 136HP Ø80	07
500400	Range Rover TD 1989/92	DIESEL	2499cc.	HR924HR 121HP Ø92	455
520300	825 TD 1996/99	DIESEL	2499cc.	VM425TD 121HP Ø92	456
SCANIA					
810000	Camión, Omnibús L75/76, L/LB/LBS110-L/LB/LS/LT/LBS/LBT111 74/...	DIESEL	11020cc.	D11 - DS11 280/333HP Ø127	153
810100	LB/LBS110, L/LS/LT/LBS/LBT111, G/L/R/T112, P113/P113HK//R113 R113HK/T113/K113CBL/K113GLP/K113TLB/K113TLP	DIESEL	11020cc.	D11 - DS11 - DSC11 272/354HP Ø127	154
810407/8	P124/R124/T124 1996/2001	DIESEL	11700cc.	DSC12.01/02 360/420HP Ø127	XXXIV
810208	R142/T142/R143/T143/R144/T144	DIESEL	14190cc.	D14 - DS14 - DSC14 400/460/500/530HP Ø127	XXXIV
SEAT					
250800	Marbella 1989/94, 133 1974/78, 850 1964/78, Panda 1980/...		843cc.	08NCA 35/45/52HP Ø65	147
250800	127, Panda 45 1972/..., Ibiza, Terra 1989/93		903cc.	08NCA - 09NCA - 164A 40/45HP Ø65	147
223608	Ibiza, Cordoba 1996/99		999cc.	AER/ALL 50HP Ø67.1	461
230600	Ibiza, Cordoba 1996/...		999cc.	AER/ALL (SOHC) 8V 50HP Ø67.1	497
222000	Ibiza 1993/94		1043cc.	AAU 45HP Ø75	476
222307	Malaga 1985/93, Ronda 1983/86		1193cc.	021A1 - 021C1 62/71HP Ø75	460
222000	Ibiza 1993/94 - 1993/99		1272cc.	2G - AAV 54HP Ø75	476
223708	Ibiza, Cordoba 1996/...		1391cc.	AEX/APQ/AKV/ANX 55/60HP Ø76.5	461
222407	Malaga 1985/93, Ronda 1984/...		1461cc.	021A2 85/90HP Ø83	460
221400	Toledo 1991/93, 1994/97, Ibiza, Córdoba 1995/97, Inca 1995/...		1595cc.	EZ - 1F 72/75HP Ø81	470
224107	Cordoba, Toledo, Ibiza, León 1999/...		1595cc.	AUR 100HP Ø81	461
224300	Ibiza 2001/03, Cordoba 2001/05		1595cc.	APF/AKL/AEH/ANA/ARM 100HP Ø81	491
223395	Cordoba, Ibiza 1993/94		1598cc.	ABU 75HP Ø76.5	484
224000	Cordoba, Ibiza 2003/...		1598cc.	BAH (SOHC) 8V 100HP Ø81	489
223708	Ibiza, Inca 1996/...		1598cc.	AEE/ALM 75HP Ø76.5	461
233100	Mii 2011/...		1598cc.	CHYA (DOHC) 60/75HP Ø74,5	509
250200	1500 1963/71		1600cc.	115C 76HP Ø78	139
222407	Ibiza Sportline 1991/93		1675cc.	021C3 98HP Ø83	460
221400	Toledo 1991/93 - 1993/97, Cordoba, Ibiza 1993/...		1781cc.	RP - ABS 90HP Ø81	470
221695	Cordoba, Toledo, Ibiza 1994/97		1781cc.	ABS - ADZ 90HP Ø81	472
221700	Alhambra Turbo 1998/..., Leon Turbo 1998/...		1781cc.	AJH - AJQ - APP Turbo 20V 150/180HP Ø81	473
223895	Cordoba, Ibiza 1994/97, Toledo GTI 1991/94		1781cc.	ADL - KR - PL 129/139HP Ø81	487
230300	Ibiza, Cordoba, Toledo 1993/94		1781cc.	ABS 90HP Ø81	495
232908	Leon - Toledo TSI		1798cc.	CDA4 160HP (DOHC) 16V Ø82,5	463



SEAT						
Ref.	Modelo/Model		Cm ³	Motor/Engine		
233200	Altea TSI, Leon TSI, Toledo TSI 2009/10		1798cc.	CDAА (DOHC) 16V 160HP Ø82,5		510
223500	Alhambra TDI 2000/...	DIESEL	1896cc.	AUY 115HP Ø79,5		486
230200	Ibiza D/TD, Cordoba 1996/99, Toledo 1997/99	DIESEL	1896cc.	1Y - AAZ 64/75HP Ø79.5		494
230900	Ibiza, Cordoba SDI/TDI, Alhambra TDI, Toledo TDI, Inca SDI 1994/...	DIESEL	1896cc.	1Z - AFN - AHU - AEY 64/90/110 Ø79.5		499
222908	Toledo - Cordoba - Ibiza - Alhambra 1994/99		1984cc.	ADY - AGG 115HP Ø82.5		460
223995	Toledo, Ibiza, - Cordoba 1991/94		1984cc.	2E 115HP Ø82.5		488
231100	Alhambra 2000/..., Cordoba, Ibiza 2002/...,2003/...		1984cc.	ATM/AZL/BBX 115HP Ø82.5		500
221900	Toledo 16V 1994/99, Ibiza, Cordoba 1996/99 - Hasta Motor 031251		1985cc.	ABF 16V 150HP Ø82.5		475
222100	Cordoba, Ibiza, Toledo 1993/99		1985cc.	ABF 16V 150HP Ø82.5		477
351600	131/132	DIESEL	1988cc.	OM 615 55HP Ø87		306
SHANGAI						
910900	Tractor			495A Tracción Simple - 485A 18Tracción Doble		157
SKODA						
233100	Citigo 2011/...		1598cc.	CHYA/CHYB (DOHC) 60/75HP Ø74,5		509
223708	Octavia, Felicia Pick Up 1996/...		1598cc.	AEE 75HP Ø76.5		461
233300	Octavia 2004/...		1598cc.	BLF (DOHC) 16V 115HP Ø76,5		511
232908	Octavia TSI 2007/...		1798cc.	BZB/CDAА 160/152HP (DOHC) 16V Ø82.5		463
233200	Octavia - SuperB - Yeti 2009/...		1798cc.	CDAB (DOHC) 16V 152HP Ø82,5		510
223400	Octavia TDI 1996/...	DIESEL	1896cc.	AGR - AGP - AHF 68/90/110 Ø79.5		485
231100	Fabia, Octavia 2000/..., Octavia 2002/...		1984cc.	AZL/AEG 115HP Ø82.5		500
SSANG YOUNG						
450400	Korando Family 1993/96	DIESEL	2498cc.	XD3 - X3DP 76HP Ø94		345
351100	Korando KJ TDI, Musso MJ TDI 1997/...	DIESEL	2874cc.	OM 602 120HP Ø89		302
351300	Korando KJ 1996/..., Musso MJ 1995/...	DIESEL	2874cc.	MB602 95HP Ø89		304
SUBARU						
950500	K87/K87L, EK23/EK24, KF1/KT1 1981/...		544cc.	EK 23/24 35HP Ø76		
SUZUKI						
241200	Fun 2002/...		999cc.	MPFI (SOHC) 8V 60HP Ø71.1		37
910400	Swift 1989/94		1298cc.	G13K (DOHC) 16V 115HP Ø74		
910300	Swift, Sidekick, Samurai, Cultus 1985/89		1324cc.	G13A 8V 64/68HP Ø74		
910200	Vitara, Sidekick, Geo, Escudo 1991/97		1590cc.	G16KC - G16A 8V 82HP Ø75		
460300	Vitara 1995/96	DIESEL	1905cc.	XUD9 68HP Ø83		364
460900	Vitara TD 1996/...	DIESEL	1905cc.	XUD9 TE 75HP Ø83		370
461307	Vitara 1995/96	DIESEL	1905cc.	XUD9 68HP Ø83		331
470800	Vitara HDI, Grand Vitara HDI 2000/...	DIESEL	1997cc.	RHZ 110HP Ø85		381
910100	Vitara TD 1996/..., Grand Vitara XL7 2000/...	DIESEL	1998cc.	RF - RHW 71/110HP Ø85		
TATA						
920700	Sumo Telcoline TDI	DIESEL	1905cc.	4DL - NA Ø83		
TOYOTA						
923007	Starlet 1985/...		999cc.	1E 54HP Ø70,5		
923007	Corolla 1984/89, Starlet 1990/96		1295cc.	2E-LC/2E-L/2E-E 75/82HP Ø73		
923300	Corolla 1999/...		1398cc.	4ZZ-FE 97HP Ø79		
922907	Carina E, Corolla 1992/..., Avensis 1997/00, Corolla, Sprinter 1987/...		1587cc.	4A-FE 106/116/116HP - 4A-GZE 115HP Ø81		
922907	Corolla, Carina FF, Celica 1987/93, Sprinter 1990/95		1587cc.	4A-F/4A-FE 90/95/105HP - 4AF-HE 95HP Ø81		
970000	Corolla, Corona, Carina, Celica, Town Ace, Camry 1976/80		1588cc.	12TU - 2TJ 74HP Ø85		
950400	Corona 1970/74		1591cc.	7R 85HP Ø86		
923300	Corolla 1999/..., Avensis 2000/..., Corolla Verso 2001/...,		1598cc.	3ZZ-FE 110HP Ø79		
950400	Corona, Mark II 1968/70		1707cc.	6R 85HP Ø86		
922907	Corolla 1992/..., Carina, Celica 1993/99, Avensis 1997/00		1762cc.	7A-FE 106/110/115/118HP Ø81		
970000	Carina, Celica, Corona, Corolla, Cressida, Camry, Town Ace 1978/80		1770cc.	13TU - 3TEU 95HP Ø85		
923300	Corolla, Celica, MR2 1989/..., Rav 4, Spider, Corolla Verso 2000/..., Matrix 2003/...		1794cc.	1ZZ-FE 123/129/135/140HP Ø79		
950400	Corona, Mark II 1973/..., Celica 1976/...		1808cc.	16R 95HP Ø88.5		
900200	Corolla, Town Ace 1982/83	DIESEL	1839cc.	1C 84HP Ø83		
920500	Corolla, Lite Ace, Town Ace 1984/88, Camry TD, Vysta TE 1983/85	DIESEL	1839cc.	1CL - 1CTL 80/88HP Ø83		



TOYOTA					
Ref.	Modelo/Model		Cm³	Motor/Engine	
950400	Corona Mark II 1969/74, Celica, Hilux Pick Up 1970/...		1858cc.	8R 105HP Ø86	
950400	Corona, Cressida, Hi Lux, Carina 1972/..., Celica, Mark II, Hi Ace 1976/...		1968cc.	18R 100/110HP Ø88.5	
920400	Town Ace D, Camry D/T, Carina II D, Carina E TD, Corona D, Lite Ace	DIESEL	1975cc.	2C/2C-T/2C-TE 73/81/83HP Ø86	
923108	Picnic, Avensis Verso, Avensis 2001/...		1998cc.	1AZ-FE/FSE 150HP Ø86	
921800	Hi Ace, Toyo Ace, Hi Lux, Crown, Chasser, Cressida, Mark II 1977/85	DIESEL	2188cc.	L 72HP Ø90	
923500	Town Ace 1985/90, Hi Lux, Van 1989/93, Lite Ace 1992/95, Dyna 200 1995/...		2237cc.	4Y - 4Y EC 94/98/101HP Ø91	
922800	Highlander 2000/..., Camry 2002/..., Rav 4, Solara, Avensis, Verso 2003/...		2362cc.	2AZ-FE 150/160HP Ø88.5 (DOHC)16V	
923108	Camry, Previa 2000/...		2362cc.	2AZ-FE 156HP Ø88.5	
923600	Corona, Celica, Hi Lux, 4 Runer 1985/95		2366cc.	22R 97HP - 22REC 105HP Ø91.9	
922500	Celica, Hi Lux, Corona, 4 Runner 1980/84		2367cc.	22R/REC 100HP Ø92	
910600	Hi Lux, Dyna, Toyo Ace, Mark II, Corona, Land Cruiser, Hi Ace, Cressida	DIESEL	2446cc.	2L 75/83HP Ø92	
921900	Hi Ace, Toyo Ace, Hi-lux, Crown, Chasser, Cresta, Cressida, Dyane,	DIESEL	2446cc.	2L - 2LT - 2LTE 75/86HP Ø92	
500400	Land Cruiser 70 TD 1987/89	DIESEL	2494cc.	VM66A 108HP Ø88	455
922400	Hi Lux, Dyna 150TD, Hi Ace TD 2001/..., Hi Lux TD, D4D 2005/...	DIESEL	2494cc.	2KD - FTV 16V 88/102HP Ø92	
500400	Land Cruiser 250 TD 1990/93	DIESEL	2499cc.	VM84A 114HP Ø88	455
920100	Hi Lux, Hi Ace, Toyo Ace, Landcruise 1988/...	DIESEL	2779cc.	3L 123HP Ø96	
900405	Coaster, Landcruiser 1980/82, Dyna 1980/88, Toyo Ace 1980/85	DIESEL	2977cc.	B 85HP Ø95	
922200	Hi-lux TD, 4 Runner TD, Land Cruiser TD 1993/96	DIESEL	2982cc.	1KZ-T/TE (SOHC) 8V 125HP Ø96	
922300	Hi Lux TD, D4D 2005/..., Land Cruiser 90/120 TD 2000/...	DIESEL	2982cc.	1KD - FTV 16V 163HP Ø96	
922100	Hi Lux LN147/152/167/172, Hi Ace LH162/172/174/181, Dyna 150	DIESEL	2987cc.	5L Ø99.5	
VALMET					
320800	Tractor 65ID, Valmet 62ID 1970/76	DIESEL	2550cc.	D225-3 50HP Ø95	112
330800	Autoelevador, E300, Tractor 68 1983/...	DIESEL	2942cc.	D229-3 72HP Ø102	116
440000	Tractor 85ID 1970/76	DIESEL	3400cc.	D225-4 68HP Ø95	119
320400	Tractor 86-ID	DIESEL	4156cc.	D226-4 82HP Ø105	111
440100	Tractor 110 ID	DIESEL	5100cc.	D225-6 102HP Ø95	120
VALTRA					
423000	A65/A75, 305/355/365/405/455/465/555/565/600/700	DIESEL	3300cc.	320D/DS Agco Sisu Power 33/69HP Ø108	01
423100	A950/A990/BM100/BM110 (4x2, 4x4)	DIESEL	4400cc.	420D/DS Agco Sisu Power 106/129HP Ø108	02
423200	8000	DIESEL	6600cc.	620D/DS Agco Sisu Power 147/189 Ø108	03
VM - BORGWARD					
500400	75TD 1984/92	DIESEL	1995cc.	VM80A 95HP Ø88	455
500400	75 TD 1989/92, 90TD 1984/97, Range Rover TD 1986/89	DIESEL	2393cc.	VM81A 110HP - VM492HT 113HP Ø92	455
500400	Land Cruiser 70 TD 1987/89	DIESEL	2494cc.	VM66A 108HP Ø88	455
500400	155TD 1993/97, 164TD 1987/92 - 1992/98, Scorpio TDI, Granada TDI Falcon 1988/..., Range Rover TD 1989/92, Land Cruiser 250 TD 1990/93	DIESEL	2499cc.	VM84A 114HP - VM08B/VM07B 125HP VM31B/VM32B 125HP - HR924HR 121HP Ø92	455
520300	Dakota TD, Grand Voyager TD, Cherokee, Grand Cherokee TD, 825 TD	DIESEL	2499cc.	VM425TD 114/115HP - VM41B 115HP Ø92 Ø92	456
520400	Jeep Cherokee, Grand Cherokee, Dakota, Caravan 2001/...	DIESEL	3100cc.	VM531TD 142HP Ø92	457
VOLKSWAGEN					
310700	Gol 1.0 1993/...		997cc.	CHT/AE Ø70.3	241
223608	Polo 1996/..., Lupo 1998/...		999cc.	AER/ALL 50HP Ø67.1	461
224200	Fox 2003/...		999cc.	AQZ - BJE 8V 71/72HP Ø67.1	490
230500	Gol 1000, Saveiro 1998/...		999cc.	AT (DOHC) 16V 69HP Ø67.08	496
230600	Gol 1000, Saveiro, Polo 1995/...		999cc.	AER/ALL (SOHC) 8V 50HP Ø67.1	497
231200	Gol Power 2002/...		999cc.	AT (SOHC) 8V 50/69HP Ø67.1	501
231300	Gol Power 2002/...		999cc.	AT (DOHC) 16V Ø67.08	502
222000	Golf, Jetta 1985/91, Polo 1985/92, 1990/94		1043cc.	HZ - AAK - ACM - AAU 45/50HP Ø75	476
222000	Golf, Jetta, Polo 1985/92 - 1987/94		1272cc.	UN - NU - 2G - AAV 55/60/75HP Ø75	476
220300	Kombi, Escarabajo, Fusca 1969/...		1285cc.	Air Cooler 39/43HP Ø77	464
223708	Polo 1994/...		1296cc.	ADX 55HP Ø76.5	461
224000	Fox 2005/..., Polo 2003/05		1390cc.	BKR/BLM (SOHC) 8V 75/86HP Ø76,5	489
232600	Gol Power		1390cc.	EA111 (SOHC) 8V 83HP Ø76,5	507
222000	Golf, Vento 1991/94		1391cc.	ABD 60HP Ø75	476
223708	Golf, Vento 1995/98		1391cc.	AEX/APQ 55/60HP Ø76.5	461



VOLKSWAGEN					
Ref.	Modelo/Model	Cm ³	Motor/Engine		
220400	Passat, Dasher (USA) 1975/80, Caddy, Jetta, Scirocco, Golf, Gacel 1975/84	1457cc.	EH/GH/JB/FT/FV/YP 75/85/110HP Ø79.5		465
220800	Passat, Golf, Dasher (USA), Scirocco, Rabbit, Brasil 1974/82	1457cc.	ZC/YJ/FL/FB/FD/FH/FK 65/85HP Ø76.5		467
220100	1500 1982/...	1498cc.	Hillman 72HP Ø86		99
300700	Saveiro, Voyage, Logus 1989/...	1555cc.	CHT/AE 73HP Ø77		210
220400	Golf, Rabbit, Passat, Scirocco, Jetta, Santana 1979/83, Caribe, Atlantic 1977/84	1588cc.	FN/FP/FS/FT/FR/FV/WP/EM/WV 75/110HP Ø79.5		465
223207	Caddy D, Jetta D/TD, Golf D/TD, Santana D/TD, Passat D/TD, TYP 2/80 Transporter, D/TD 1985/93	DIESEL 1588cc.	CS/JX/JP/CY/JK/RA/SB/CR/SV/1V/ME/JR 49/54/70/80HP Ø76.5		460
230100	Senda, Saveiro, Caddy, Golf D/TD, Passat, Kombi, Santana 1981/86	DIESEL 1588cc.	CR/JK/JP/JR/JF/JX/CS/CY 49/54/70HP Ø76.5		493
220600	Gacel, Senda, Voyage, Gol, Santana, Passat, Apollo, Logus 1985/...	1595cc.	AP 70HP Ø81		466
221400	Golf, Jetta, Passat, Caddy 1983/92, Scirocco 1970/92, Polo Classic 1995/...	1595cc.	RF/1F/FN/PP/EZA/ABN/EW/EZ/HM 70/75HP Ø81		470
224107	New Beetle, Bora, Golf 2000/...	1595cc.	AYD/AVU 100HP Ø81		461
224300	Derby, Bora, Passat, Golf 1999/...	1595cc.	APF/AKL/AEH 100HP Ø81		491
223395	Golf, Vento 1992/94	1598cc.	ABU 75HP Ø76.5		484
224000	Polo, Caddy 1997/01, Gol 2001/..., Lupo 2004/09, Fox 2005/..., Fox Route, Suran 2006/..., Voyage, Gol Trend	1598cc.	BAH/BLH/BJA/BPA (SOHC) 8V 100HP Ø76.5		489
223708	Vento, Polo 1994/..., Caddy 1997/...	1598cc.	AEA/AEE 75HP Ø76.5		461
233100	Up 2011/...	1598cc.	CHYA/CHYB (DOHC) 60/75HP Ø74,5		509
233300	Golf FSI, Touran, Passat, Jetta FSI 2005/... - Eos FSI, Polo, Crosspolo 2006/...	1598cc.	BTS/BLF (DOHC) 16V 105/115HP Ø76,5		511
233400	Suran Cross, Saveiro, Novo Fox, Gol Rallye, Saveiro Cross 2015/...	1598cc.	EA211 (DOHC) 16V 110HP Ø76.5		512
220400	Rabbit, Dasher (USA) 1980/84, Jetta 1981/84, Scirocco 1981/83, Quantum 1982/83, Caribe, Atlantic 1977/84	1714cc.	EN 77/80HP Ø79.5		465
220600	Gacel, Senda, Voyage, Gol, Santana, Passat, Apollo, Logus 1984/...	1781cc.	AP 70HP Ø81		466
221400	Passat 1982/93, Santana 1983/90, Golf, Jetta 1984/93, Quantum 1984/85, Golf Cabriolet 1985/93, Fox 1987/93, Vento 1991/93	1781cc.	DS/DZ/PB/RF/RP/EV/GX/AAM/ABS/GU 75/85/90/95/112HP Ø81		470
221695	Vento 1992/97, Passat 1991/96	1781cc.	AAM - ABS - ADZ 75/90HP Ø81		472
221700	New Beetle, Passat 1999/..., Golf, Sharan 1997/..., Bora 2000/...	1781cc.	AGU/ARZ/AJH/AWU/AWC/ARG/APT 125/150HP Ø81		473
221800	Passat 1996/99 - 1999/..., Passat Turbo 1996/98	1781cc.	AEB/ANB 150HP - AFY/ADR 115HP Ø81		474
223895	Golf 1989/91, Scirocco 1985/92, Jetta 1986/87, Passat, Corrado 1990/92	1781cc.	KR 130HP Ø81		487
230300	Golf 1991/99, Vento 1992/97, Polo Classic, Passat 1991/96, Jetta 1994/96	1781cc.	AAM/ABS/ADZ/ADD 75/90HP Ø81		495
220100	1800 1982/...	1798cc.	Hillman 110HP Ø86		99
232908	Passat TSI 2007/...	1798cc.	BZB/CDAACDAB 160/152HP (DOHC) 16V Ø82.5		463
233200	Passat TSI 2007/...	1798cc.	CDAACDAB (DOHC) 16V 152/160HP Ø82,5		510
231600	Golf, Jetta, Combi Panel 1992/99	1800cc.	L4 F.I. 90HP Ø91		505
223400	Bora, Golf SDI/TDI 1997/...	DIESEL 1896cc.	ALH - AHF - AGR - AGP 68/90/110HP Ø79.5		485
223500	Passat TDI 1999/..., Sharan TDI 2000/..., Transporter TDI 2003/...	DIESEL 1896cc.	ATJ/AUY 115HP - AXB 105HP - AXC 85HP Ø79.5		486
230200	Passat TD 1994/96, Golf D/TD, Vento D/TD, Polo D, Caddy 1995/...	DIESEL 1896cc.	1Y - AAZ - AEY 64/75HP Ø79.5		494
230900	Golf SDI/TDI 1993/95-1999/..., Vento SDI/TDI, Sharan TDI 1993/96, Passat TDI 1993/95-1995/..., Polo TDI/SDI 1995/96, Caddy SDI 1995/...	DIESEL 1896cc.	AHU/AVG/AEY/1Z/AFN/AHH 64/90/110HP Ø79.5		499
232400	Pick Up Amarok TDI 2010/... Inyección directa Common Rail	DIESEL 1968cc.	CDBA - CDCA 90/120HP Ø81		506
221000	Golf, Passat 1992/96, Polo 1999/..., Golf Cabrio 1999/02 - Desde Motor 031252	1984cc.	ATU-AWF-AWG-ABA - AKR 115HP Ø82.5		468
222908	Passat - Golf - Vento 1994/97 - Sharan 1995/,,	1984cc.	ADY - AGG - AEP 107/115HP Ø82.5		460
223995	Golf GTI, Vento, Passat, Corrado 1991/94	1984cc.	2E 115HP Ø82.5		488
230000	Carat, Quantum, Pointer, Gol, Golf, Santana 1989/...	1984cc.	Audi 827 107/115HP Ø82.5		492
231100	Golf, New Beetle, Transporter Minibus 2002/..., Touran, Caddy, Bora 2005/...	1984cc.	BEH/BER/AZG/AXA /AEG 115HP - BSX 109HP Ø82.5		500
232908	Golf, Eos, Tiguan, Passat, Scirocco, Jetta FSI 2007/...	1984cc.	CBFA/CCTA/CCZA/CAWB/CCZB 170/210HP Ø82.5		463
233000	Santana 1998/...	1984cc.	AP 8V 107/115HP Ø82.5		508
221900	Golf, Passat 1992/96 Hasta Motor 031251	1985cc.	ABF 16V 150HP Ø82.5		475
222100	Golf, Passat, Passat Variant 1992/97	1985cc.	ABF 16V 150HP Ø82.5		477
231100	Polo BR 2002/...	1985cc.	BBX 116HP Ø82.5		500
222200	Passat, Santana 1983/88	1994cc.	JS - HP 115HP Ø81		478
222200	Passat, Quantum 1985/88	2226cc.	KV - HY 115/120/136HP Ø81		478
923500	Taro 1989/94	2237cc.	4Y 94HP Ø91		
221100	Transporter T4, Syncro 1992/99, Eurovan, Caravelle 1997/...	DIESEL 2370cc.	AAB - AJA 75/78HP Ø79.5		469
221500	Transporter T4, Transporter Syncro TDI, Transporter T4 TDI, LT SDI	DIESEL 2459cc.	AJT - AGX - ACV 75/88/102HP Ø81		471



VOLKSWAGEN					
Ref.	Modelo/Model	Cm³	Motor/Engine		
231500	Eurovan 2001/04	2461cc.	AET/APL/AVT/L5 115HP Ø81		504
231400	Bora, Vento 2005/09	2480cc.	L5 BGP/BGQ 148/168HP Ø82,5		503
230700	Passat VR6 1991/96, Golf VR6, Vento VR6 1992/97, Jetta 1993/...	2792cc.	AAA 174HP Ø81		498
330500	LTDI 1997/..., Electronico 2002/06	DIESEL 2796cc.	AGK-ATA 125/132HP - BCQ 158HP Ø93		319
331100	LT TDI Electronico 2002/06	DIESEL 2796cc.	BCQ 158HP Ø93		321
230700	Passat VR6 1994/96, Golf VR6 1994/97	2862cc.	ABV V6 190HP Ø82		498
232808	Touareg - Touareg TSI 2010/...	2995cc.	CJTA/CGFA/CGEA V6 24V 290/333HP Ø84.5		463
232708	Passat FSI 2005/...	3168cc.	AXZ V6 (DOHC) 24V 250HP Ø86		462
232508	Touareg 2003/06, Golf 2005/..., Eos 2006/..., Golf 2007/...	3189cc.	BAA/BMX/BRJ 220HP BUB/CBRA 250HP VR6 Ø84		462
232508	New Beetle RSI 2000/01	3189cc.	AXJ 225HP VR6 (DOHC) 24V Ø84		462
232508	Golf 2002/04, Touareg 2003/06, Phaeton 2003/07, Transporter 2004/...	3189cc.	BFH/BKL/BRK/ADZ/BKJ/BMV/BDL (DOHC) 24V Ø84		462
232708	Q7 2006/...	3597cc.	BHK - VR6 V6 (DOHC) 24V 280HP Ø89		462
232708	Passat FSI - Eos - Phaeton - Touareg FSI 2005/...	3597cc.	BHK/BHL/BLV VR6 V6 (DOHC) 24V 280HP Ø89		462
330400	7100/8120/8140/8150/13150	DIESEL 4300cc.	4.10 X10 90HP - 4.10T/TCA 133/167HP Ø103	113	
331200	Constellation 13.180E/15.180E	DIESEL 4800cc.	4.12TCE Common Rail 150/180HP Ø105	117	
330700	13180/15180/16210	DIESEL 6450cc.	6.10 X10 139HP - 6.10T/TCA 201/250HP Ø103	114	
331300	26.260E/31.260E/17.260EOT/17.210EOD	DIESEL 7118cc.	6.12 TCE 210/260/310HP Common Rail Ø105	118	
870600	17220/17300/17310/18310 2003/...	DIESEL 8270cc.	ISCe6 24V 315HP Ø114	22	
VOLVO					
580595	66 1973/...	1289cc.	B130/B130S 57HP Ø73		436
321600	C30, S40, V50 2005/...	1596cc.	B4164S3 (DOHC) 16V 101HP Ø79		260
570600	S40/V40 B4184S 1995/...	1731cc.	B4184S 115HP Ø83		429
580900	440TD, 460TD 1994/97, V40TD, S40TD 1996/99	DIESEL 1870cc.	D19T - D4192T 90HP Ø80		439
581608	S40, V40 TD 2001/...	DIESEL 1870cc.	D4192T3 115HP -D4192T4 102HP Ø80		400
570600	S40/V40 B4204S/T 1996/...	1948cc.	B4204S 140HP - B4204T 160HP Ø83		429
324700	S40, V50, C70, C30, S80, V70 2004/08 - 2007/...	2551cc.	B524T3/T6/T7/T8 - 200/220/230HP Ø83		281
880908	B7, FL7 1985/... - FL7, FS7 1991/... - B7R 1998/...	DIESEL 6725cc.	TD71 230/245HP - TD73E/ES 230/260HP Ø104.8	XXXV	
331300	VM210/260/310	DIESEL 7118cc.	6.12 TCE 210/260/310HP Common Rail Ø105	118	
880000	B58, B10M 1987/...	DIESEL 9600cc.	THD 101 KC 273/310HP Ø120.6	159	
880100	B58 1980/85	DIESEL 9600cc.	THD 100D 230/260HP Ø120.6	161	
880200	N10 1980/85	DIESEL 9600cc.	TD 100A 230/260HP Ø120.6	163	
880300	N10 1985/89	DIESEL 9600cc.	TD 100G - 101G - 101F 273/300HP Ø120.6	165	
880500	NL10 1998/	DIESEL 9600cc.	EDC Ø120.6	169	
880600	NL10 1989/97	DIESEL 9600cc.	TD 102F - 102FS 234/317HP Ø120.6	171	
880208	N12 1980/89	DIESEL 11950cc.	TD 121G/120GA/121F 295/328/360/385HP Ø130.2	XXXV	
880400	N12 1980/89	DIESEL 11950cc.	TD 121G/120GA/121F 295/328/360/385HP Ø130.2	167	
880700	NL12 1997/...	DIESEL 11950cc.	EDC Ø120.6	173	
880800	NL12 1989/96	DIESEL 11950cc.	TD 122FS 396HP Ø130.2	175	
WILLYS					
540900	Jeep, CPW Universal, Rastrojero, 4, 63, 2WD/4WD 1940/74	2199cc.	CJ2A-CJ3A - DJ3A 52HP Ø79.38		513
YUE YING					
930100	1041, NJ 41029 1996/...	DIESEL 3268cc.	4BC2 - 4BD1 87/88HP Ø102		
	Ver Catálogo Vehicular See Automotive Catalog		Ver Catálogo Línea Asiático Asiatic Catalog		Ver Catálogo Línea Pesada Heavy Duty Catalog

Calidad

Taranto ha certificado la Norma ISO 9001 y ISO/TS 16949 de calidad, la norma ISO 14001 de gestión ambiental y OHSAS 18001. Además ha sido reconocida por la excelencia en sus sistemas de gestión mediante la obtención del:

- * Premio Nacional a la Calidad, año 2000
- * Premio Iberoamericano a la Calidad, año 2003
- * Premio Nacional a la Calidad, año 2005.



Quality

Taranto has certified international standards of quality such as ISO 9001 and ISO/TS 16949, international standards of environmental management ISO 14001 and OHSAS 18001. In addition it has been recognized by the excellence in his systems of management obtaining:

- * The National Quality Award in 2000
- * The Ibero American Quality Award in 2003
- * The National Quality Award in 2005.

Todos los derechos reservados. Ninguna parte de esta publicación puede ser reproducida, almacenada por sistema de microfilm ni transmitida por medios electrónicos, fotocopia, grabación ni de ninguna otra manera, sin la previa autorización del titular del copyright.

All rights are reserved. None of the parts of this publication shall be reproduced, kept in a microfilm system or transmitted by electronic means, copied or taped by any other method without the previous agreement of the copyright owner.



ANTIGUA EXPRESIÓN DE CÓDIGO TARANTO

NUEVA EXPRESIÓN DE CÓDIGO TARANTO

FORMADO POR CINCO DÍGITOS



REFERENCIA ANTERIOR

FORMADA POR SEIS DÍGITOS



REFERENCIA NUEVA



DOS PRIMEROS DÍGITOS

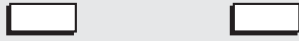

INDICA EL RUBRO O LINEA AL CUAL PERTENECE EL ARTÍCULO

ARTÍCULOS DE FABRICACIÓN

- 14 → AUTO UNIÓN
- 15 → CITROËN
- 20 → CHEVROLET - OPEL
- 21 → CHEVROLET - BEDFORD
CIMARRON - DI TELLA
- 22 → DODGE - CHRYSLER - VW
- 23 → VW - FORD
- 24 → CHEVROLET - GM
- 25 → FIAT
- 26 → FIAT
- 27 → FIAT
- 28 → CHEVROLET - GM
- 30 → FORD - VW
- 31 → FORD - MWM
- 32 → FORD - MWM
- 33 → FORD - MWM
- 35 → MERCEDES BENZ
- 36 → MERCEDES BENZ
- 40 → PERKINS / MF. / PF
- 41 → PERKINS / MF.
- 42 → PERKINS / MF.
- 43 → MAXION
- 45 → PEUGEOT - INDENOR
- 46 → PEUGEOT
- 47 → PEUGEOT
- 50 → RASTROJERO - INDENOR
VM - BORGWARD
- 51 → CHRYSLER
- 52 → CHRYSLER
- 54 → IKA - RENAULT - WILLYS
- 55 → RENAULT
- 56 → RENAULT - DACIA
- 57 → RENAULT
- 58 → RENAULT
- 65 → DEUTZ

- 66 → DEUTZ
- 70 → FIAT TRACTORES
- 71 → FIAT TRATOR - CAMINHÃO
- 75 → HANOMAG
- 80 → FIAT CAMINHÕES / IVECO
- 81 → SCANIA VABIS
- 85 → JOHN DEERE
- 86 → HONDA - ROVER
- 87 → CUMMINS
- 90 → ASIA MOTORS - KIA
NISSAN
- 91 → KIA - MITSUBISHI
SUZUKI - TOYOTA
- 92 → TATA
- 93 → ISUZU
- 94 → DAEWOO
- 95 → DAIHATSU - BMW
MITSUBISHI - TOYOTA
SUBARU
- 96 → MITSUBISHI
- 97 → TOYOTA - MAZDA - LADA
- 98 → BMW
- 99 → HYUNDAI

TERCER Y CUARTO DÍGITO

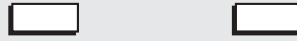

ESPECIFICA E INDICA EL TIPO DE MODELO AL QUE PERTENECE

ARTÍCULOS DE FABRICACIÓN

EJEMPLOS

CITROËN

- 00 → 2CV 14HP
- 01 → 2CV 18HP
- 02 → 3CV
- 04 → AMI 8

FIAT

- 00 → 1100
- 01 → 600
- 02 → 1500
- 03 → 1600
- 04 → 128 1100cc.
- 05 → 128 1300cc.
- 06 → 128 1500cc.
- 07 → 125
- 08 → 133
- 09 → REGATTA 100S
- 11 → DUCATO 2.8
- 20 → BRAVO/A TD
- 21 → BRAVO/A JTD

FORD

- 00 → FALCON 7B
- 01 → FALCON SP
- 02 → V8 FASE 1
- 03 → TAUNUS 2.0
- 04 → TAUNUS 2.3
- 05 → V8 FASE 2
- 06 → SIERRA 1.6
- 08 → A/AA
- 09 → FALCON 4B
- 14 → ESCORT 1.6
- 20 → TRANSIT 2.5
- 21 → FIESTA 1.4

PERKINS

- 00 → 4-203
- 01 → 6-305
- 02 → 6-354 F2
- 03 → 6PF-305
- 04 → 6-354 F4
- 05 → P3-152
- 06 → PF-MF
- 07 → MF M165-265
- 08 → MF 1095-1098
- 09 → 6-354 F1
- 10 → GM D20 3.9

PEUGEOT

- 00 → 404
- 01 → 504 1.6
- 02 → 504 1.8
- 03 → 504 2.0
- 04 → 504 XD2
- 05 → 505
- 06 → 505 I
- 07 → 505 XD3
- 09 → 403
- 15 → 205 1.0
- 16 → 106 1.4
- 17 → 106 1.2
- 18 → 104 1.2

RASTROJERO

- 00 → 42 HP
- 01 → 52 HP
- 02 → INDENOR 4,88
- 03 → INDENOR 6 CIL
- 04 → VM/BORGWARD

QUINTO Y SEXTO DÍGITO

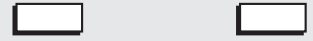

DETERMINA EL TIPO DE JUNTA

ARTÍCULOS DE FABRICACIÓN

- 00 → Jgo. Junta Motor
- 01 → Jgo. Motor sin Tapa Cilindros
- 05 → Jta. Tapa Cilindro Metalamianto
- 06 → Jta. Tapa Cilindro Supermedida
- 07 → Jta. Tapa Cilindro Libre de Amianto
- 08 → Jta. Tapa Cilindro Metálica
- 10 → Jta. Tapa de Válvulas
- 11 → Jta. Cártter
- 12 → Jta. Distribución
- 13 → Jta. Contratapa Distribución
- 14 → Jta. Bomba de Agua
- 15 → Jta. Múltiple Escape Ferroflex y Chapa
- 16 → Jta. Múltiple Escape Ferroflex
- 17 → Jta. Múltiple Admisión
- 18 → Jta. Salida de Escape
- 19 → Jta. Placa de Agua
- 20 → Jgo. Junta Carburador
- 21 → Jgo. Junta Carburador
- 22 → Jgo. Junta Carburador
- 23 → Jgo. Junta Carburador
- 24 → Jgo. Junta Carburador
- 25 → Jta. Base Carburador
- 26 → Jta. Tapa Carburador
- 27 → Jta. Bomba Aceite a Block
- 28 → Jta. Bomba de Nafta
- 29 → Arandela Tapón Cártter
- 30 → Arandela Tapa de Válvulas
- 36 → Jta. Tapa Válvulas Lateral
- 50 → Jgo. Caja de Velocidades
- 57 → Junta Palier
- 58 → Jgo. Bancada Cigüeñal
- 59 → Jta. Diferencial
- 60 → Jta. Cártter CGT
- 70 → Jgo. Suplemento Camisas
- 85 → Suplemento de Tapa
- 95 → Jgo. de Juntas Superior

FORMACIÓN DE CÓDIGOS DE RETENES

	SEGUNDO Y TERCER DÍGITO	CUARTO Y QUINTO DÍGITO	SEXTO Y SÉPTIMO DÍGITO	OCTAVO DÍGITO							
	<table border="1"><tr><td> </td><td> </td></tr></table>			<table border="1"><tr><td> </td><td> </td></tr></table>			<table border="1"><tr><td> </td><td> </td></tr></table>			<table border="1"><tr><td> </td></tr></table>	
	INDICA LA MARCA O LA LINEA DEL ARTÍCULO	INDICA EL TIPO DE MOTOR	INDICA TIPO DE RETÉN SEGÚN SU APLICACIÓN	INDICA MATERIAL							
PRIMER DÍGITO		EJEMPLOS									
R	14 → AUTO UNION 15 → CITROEN 20 → CHEVROLET 21 → CHEVROLET 22 → DODGE - VW 23 → VW - FORD 24 → CHEVROLET 25 → FIAT 26 → FIAT 27 → FIAT 28 → CHEVROLET 30 → FORD - VW 31 → FORD - MWM 32 → FORD	CITROËN 00 → 2CV 14HP 01 → 2CV 18HP 02 → 3CV 04 → AMI 8 FIAT 00 → 1100 01 → 600 02 → 1500 03 → 1600 04 → 128 1100cc. 05 → 128 1300cc.	00 → KIT DE RETENES 10 → GUÍAS DE VÁLVULAS 11 → BANCADA 12 → DISTRIBUCIÓN 13 → ÁRBOL DE LEVAS 15 → RET. ADICIONAL 47 → VELOCÍMETRO 48 → SELECTOR CAJA DE VELOCIDAD 49 → EJE CAMBIO 50 → SALIDA DA CAJA 51 → DE DIRECTA 52 → SALIDA DE PALIER 55 → RUEDA TRAS. EXT.	56 → RUEDA TRAS. INT. 57 → DE PIÑÓN 58 → RUEDA DEL. EXT. 59 → RUEDA DEL. INT. 60 → SEMI-EJE							
INDICA LINEA DE RETENES				N - NITRILÓ CAUCHO NITRILICO S - SILICONA CAUCHO DE SILICONA P - POLIACRÍLICO CAUCHO DE POLIACRÍLICO V - VITÓN CAUCHO FLUORADO VF - VIFLON T - TEFLÓN POLITETRA FLUOR ETILENO							
PRIMER DÍGITO											
PR	35 → MERC. BENZ 36 → MERC. BENZ 40 → PERKINS - MF 41 → PERKINS - MF 42 → PERKINS 45 → PEUGEOT 46 → PEUGEOT 50 → RASTROJERO INDENOR 54 → IKA - RENAULT JEEP WILLYS 55 → RENAULT 58 → RENAULT										
INDICA LINEA DE PORTA RETENES											



SÍMBOLOS - SYMBOLS

Jgo. de juntas para motor con retenes Full set gaskets with oil seals		Jgo. de tornillos para tapa de cilindros Cylinder head bolts		Junta salida escape Exhaust pipe seals gaskets	
Jgo. de juntas para motor sin retenes Head set gaskets without seals		Herramientas especiales para motor Set of special automotive tools		Suplemento camisa cilindro Camma cylinder gaskets	
Jgo. de juntas p/motor sin tapa con retenes Full set gaskets without head with oil seals		Sellador Líquido - Caucho de Silicona Liquid Sealant - Silicone Rubber		Kit retenes completo Oil Seals (Set)	
Jgo. de juntas p/motor sin tapa sin retenes Full set gaskets without head without oil seals		Junta tapa de válvulas Valve gaskets		Jgo. retén válvulas Valve seal set	
Jgo. de juntas superior con retenes Head set gaskets with oil seals		Junta para cárter Rear main bearing seals gaskets		Retén bancada Rear crankshft seal	
Jgo. de juntas superior sin retenes Head set gaskets without seals		Junta tapa distribución Timing cover gaskets		Retén distribución Front crankshft seal	
Junta tapa cilindro Cylinder head gaskets		Junta bomba de agua Water pump and water exit gaskets		Retén árbol de levas Camshaft seal	
Junta tapa cilindro - No retorqueable Cylinder head gaskets - Non retorqueable		Junta múltiple admisión y escape Intake and exhaust manifolds gaskets		Porta retén bancada Rear crankshft seal	
Junta tapa cilindro izquierda Left Cylinder head gaskets		Junta múltiple admisión Intake manifolds gaskets		Porta retén distribución Front crankshft seal	
Junta tapa cilindro derecha Right Cylinder head gaskets		Junta múltiple escape Exhaust manifolds gaskets		Espesor Thickness	

ABREVIATURAS MATERIALES - ABBREVIATION OF MATERIALS

AC Acero Inoxidable Stainless Steel	CEL Celulosa Cellulose	NH Libre Amianto Comprimido Compressed Asbestos Free
ACO Acero Cobreado - Libre Amianto - Acero Cobreado Steel Copper - Asbestos Free - Steel Copper	F Fibra Fiber	MLS Multilamina Sterling Multisheet Sterling
AL Aluminio Aluminium	FCH Ferroflex con respaldo de chapa Ferroflex with tin shoulder	P Poliacrílico - Retenes con casco de acero Polyacrylic - Oil Seals with steel cap
BAK Bakelita - Nonasbesto/Bakelita Bakelite - Nonasbesto/Bakelite	FIE Fieltro Felt	PB Plomo Lead
CB Base Celulosa Cellulose Base	GFT Grafito con alma metálica Graphite with metallic core	PLAST Plástico Plastic
CG Corcho y Goma Cork and Rubber	GS Goma sintética - Nitrilo Synthetic Rubber - Nitrile	S Silicona - Retenes con casco de acero Silicone - Oil Seals with steel cap
CGT Corcho y Goma con Tela Cork and Rubber with Cloth	H Hojalata Tin Plate	SLS Sterling - Polystrat Sterling - Polystrat
CHA Chapa/Hojalata sin material blando Tin Plate without soft material	L Latón - Bronce Brass	SNA Soga libre de amianto Rope asbestos free
CN Arandelas blindadas (Cobre - Libre Amianto) Armored washers (Copper - Asbestos Free)	N Retenes de nítrico con casco de acero Nitrile oil seals with steel cap	T Teflón Teflon
CNC Cobre - Libre Amianto - Cobre Copper - Asbestos Free - Copper	NB Libre Amianto (Beater) Asbestos Free (Beater)	V Vitón - Retenes con casco de acero Viton - Oil Seals with steel cap
CU Cobre Copper	NFT Ferroflex Base Libre Amianto Ferroflex Base Asbestos Free	VS Varios Miscellaneous

Los números originales también indicados en este catálogo tienen relación únicamente en sentido de informar y verificar. Sírvase usar en sus pedidos, facturas recibos solamente los códigos TARANTO.

Os números originais indicados neste catálogo servem somente para informação e verificação. Utilizar nos pedidos, faturas e recibos somente os códigos TARANTO.

Original part numbers also indicated in this catalog are intended only to inform and verify. Please, indicate only TARANTO reference numbers in your order forms, invoices and shipping notes.

Die in diesem katalog aufgeführten nummern dienen ausschlie bich informations-und Vergleichszwecken. Bitte verwenden sie thren rechnungen, lieferscheinen und bestellungen nur TARANTO-nummern.

Les références de pièces d'origine indiquées sur ce Catalogue ont exclusivement le sens d'information et de vérification. Veuillez indiquer sur vos factures, bons de livraison et de commandes le numéro TARANTO.

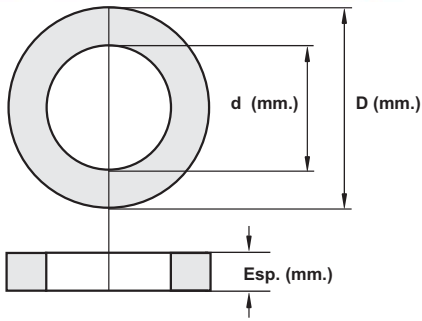

- > Diámetro interior d (mm)
- > Diámetro exterior D (mm)
- > Espesor Esp.(mm)
- > Diâmetro interno d (mm)
- > Diâmetro externo D (mm)
- > Espessura Esp.(mm)
- > Inner diameter d (mm)
- > Outer diameter D (mm)
- > Thickness Esp.(mm)

FORMACIÓN DE CÓDIGOS DE ARANDELAS

A 6 x 10.5 x 2 →

A
INDICA
ARANDELAS

6
INDICA d (mm)
Ø Interior

x
10.5
INDICA D (mm)
Ø Exterior

x
2
INDICA ESPESOR
(mm)

C
INDICA TIPO
DE MATERIAL

MATERIALES

AL	ALUMINIO	ALUMÍNIO	ALUMINUM	H	FERRO	HIERRO	IRON
NH	LIBRE AMIANTO COMPRIMIDO	SEM AMIANTO COMPRIMIDO	ASBESTOS FREE COMPRESSED	F	FELTRO	FIELTRO	FELT
C	COBRE	COBRE	COPPER	N	NYLON	NYLON	NYLON
F	FIBRA	FIBRA	FIBER				

ARANDELAS POR DIÁMETRO INTERIOR

				MATERIAL										MATERIAL										MATERIAL																
d (mm)	D (mm)	Esp		AL	NH	C	F	H	L	d (mm)	D (mm)	Esp		AL	NH	C	F	H	L	d (mm)	D (mm)	Esp		AL	NH	C	F	N	L	d (mm)	D (mm)	Esp		AL	NH	C	F	H	L	
4	7	1					●			7	17	1.5						●			10	13	1		●		●				12	17	1.5				●			
4	8	1	●							7	17	1						●			10	14	1.25		●						12	17	2				●			
5	8	1	●		●	●				8.3	11.6	1				●				10	14	1.5		●						12	18	1.5	●		●					
6.5	12	0.5					●			8.5	11.5	1					●			10	14	1				●	●			12	18	1				●				
6.8	13.5	1	●							8.5	12	1				●				10	15	1.5		●						12	18	2				●				
6	10.5	2			●					8	10	1	●							10	15	1				●				12	18	3	●		●					
6	10	1.5		●						8	11	1	●				●			10	16	0.5					●			13	16	0.5	●							
6	10	1	●		●	●				8	12	1	●		●	●				10	16	1	●		●	●				13	16	2			●					
6	10	2							●	8	12	1						●		10	16	2.5				●				13	17	1			●					
6	11	2			●					8	13	1	●		●					10	18	1				●				13	17	2	●							
6	8	0.5					●			8	13	2.5				●				10	18	2	●							13	18	1.5			●					
6	8	1	●		●					8	14	0.5				●				10	19	2				●				13	19	1				●				
6	9	0.5	●			●				8	14	1.5		●	●					10	20	1.5	●							13	20	1	●			●				
6	9	1	●		●	●				8	14	1	●		●					10	20	1				●				13	20	2	●							
6.5	10	1			●					8	18	1.5	●			●				10	20	2				●				13	21	1.5				●				
6.5	12	1			●					8	20	1.5	●							10	21	2				●				13	24	3					●			
7.5	15	2			●					9.4	18	1					●			11	15	1					●			14.5	21	2			●					
7	8.9	1.9						●		9.5	12	1.5	●							11	16	1	●			●				14	17.2	2			●					
7	10	1	●		●	●				9.5	12	1	●							11	17	1.25				●				14	18	1.25	●							
7	11	1			●	●				9.5	14.5	1						●		11	18	1.5	●		●					14	18	1.5			●					
7	12.5	1			●					9.5	20	1			●					11	18	2			●					14	18	1	●		●					
7	12.5	2			●					9.5	20	2			●					12.7	16	1	●							14	18	1.25			●					
7	13	1.5	●							9.7	13	1					●			12.8	22.8	2						●		14	19	1.5			●					
7	13	1			●					9	11	0.8	●							12	14	0.5	●							14	20	1.25	●							
7	13	4				●				9	13	0.5			●					12	15	1.5			●					14	20	1.5	●		●	●				
7	14	1					●			9	13	1	●							12	15.2	1			●					14	20	1			●					
7	15	1				●				9	13	1			●	●				12	16	1.5	●		●					14	20	2			●					
7	15	1.5			●					9	14	1			●					12	16	1	●		●	●				14	21	1.5			●					
7	15	2			●					9	17	1.5			●					12	17	1	●		●					14	22	1.5			●					

ARANDELAS - ANILLOS - O'RINGS

Washers - Rings - O'rings



MATERIAL							MATERIAL							MATERIAL							MATERIAL														
d (mm)	D (mm)	Esp	AL	NH	C	F	H	L	d (mm)	D (mm)	Esp	AL	NH	C	F	H	L	d (mm)	D (mm)	Esp	AL	NH	C	F	H	L	d (mm)	D (mm)	Esp	AL	NH	C	F	H	L
14	22	2			●				16	24	1			●				20	26	0.5			●				24	38	1.25	●					
14	24	1.5	●						16	24	1.5	●						20	26	1.5			●				25	29.5	1			●			
14	24	2			●				17	21	0.5			●				20	26	1	●		●				25	29	2			●			
14.7	21	2			●				17	21	1.25			●				20	26	2				●			26	31	2			●			
15.5	17	1.5			●				17	21	1.5			●				20	28	1	●		●				26	32	1.25	●					
15	18	1	●						17	22	1.25	●						21	30	2	●						26	32	2	●					
15	19	1.5	●						17	22	1.5			●				22.5	29	2	●		●				26	34	2	●					
15	20	1			●				17	22	1	●		●				22	26	1.5			●				27	32	1.5			●			
15	21	1.5	●						18	22	1.5	●		●				22	27	1	●						28	34	1.5	●					
15	21	1.5			●				18	22	2			●				22	27	1.25	●						28	36	0.5	●					
15	21	2	●		●				18	23	1.25	●		●				22	27	1.5			●				28	38	1.5			●			
16	19	1.5			●				18	23	1	●		●				22	27	1			●				30	36	2	●		●			
16	20	1	●			●			18	23	2			●				22	28	1.25	●						31	36	1.5	●					
16	20	1.5			●				18	24	1			●				22	28	1.5			●				32	36	0.5			●			
16	21	1.25	●						18	24	1.5			●				22	29	1.5	●						32	36	1			●			
16	21	1.5			●				19	24	1.5	●						22	29	3	●						35	41	2			●			
16	21	1	●						19	26	1.5			●				22	32	1.5			●				36	42	1.5	●					
16	21	2			●				19	27	2	●						24	29	2			●				40	47	1			●			
16	22	1.5	●		●				19.5	27	1	●						24	30	1.5	●						40	60	1.5			●			
16	22	1			●	●			20.5	5.5	1	●						24	32	1.5	●						45	52	2	●					
16	22	2			●				20	24	1.5	●		●				24	32	2	●														

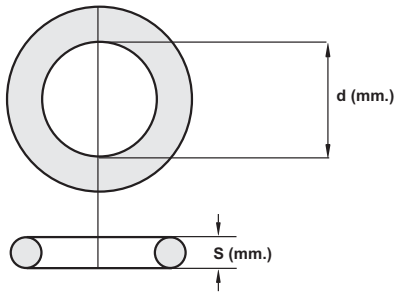

> Diámetro interior d (mm) > Diâmetro interno d (mm) > Inner diameter d (mm)
 > Sección S (mm) > Seção S (mm) > Section S (mm)

FORMACIÓN DE CÓDIGOS DE O'RING

G 18.77 x 1.78 S



G
INDICA LINEA DE O'RING

18.77
INDICA d (mm) Ø Interior

x

1.78
INDICA S (mm) Sección

S
INDICA TIPO DE MATERIAL

MATERIALES

N NITRILICO NITRILICA NITRILE S SILICONA SILICONE SILICONE V VITÓN FLUOR ELASTOMERO FLUORELASTOMERS

O'RING - SERIE STANDARD

1.78
S (mm)

d (mm)	MATERIAL			d (mm)	MATERIAL			d (mm)	MATERIAL			d (mm)	MATERIAL			d (mm)	MATERIAL						
	N	S	V		N	S	V		N	S	V		N	S	V		N	S	V				
1.42	●			4.47	●			12.42	●			23.52	●			50.52	●			66.4	●		
1.78	●			5.28	●			15.6	●		●	28.3	●			53.7	●			69.57	●		
2.57	●			6.07	●			17.17	●			34.65	●			56.87	●		●	101.32	●		
2.9	●			7.65	●			18.77	●		●	44.17	●			60.05	●						
3.68	●			9.25	●			21.95	●			47.35	●			63.22	●						

2.62
S (mm)

7.59	●			13.11	●			17.12	●			23.47	●			30	●			37.77	●		
9.19	●			13.94	●			18.72	●			26.64	●			31.42	●			39.34	●		
9.5	●			15.54	●			20.30	●			28.24	●			32.99	●			40.94	●		
12.37	●			17.12	●		●	21.89	●			29.82	●			36.17	●		●	34.59	●		



ARANDELAS - ANILLOS - O'RINGS

Washers - Rings - O'rings

O'RING - SERIE STANDARD

S (mm)	MATERIAL				MATERIAL				MATERIAL				MATERIAL				MATERIAL							
	d (mm)	N	S	V	d (mm)	N	S	V	d (mm)	N	S	V	d (mm)	N	S	V	d (mm)	N	S	V				
2.62	44.12	●			53.64	●			58.42	●			66.34	●			72.69	●			90	●		
	48.9	●			55.25	●			61.60	●			67.95	●			82.22	●			126.67	●		
	52.07	●			56.82	●			64.77	●			69.52	●			88.57	●			158.42	●		
3.53	4.34	●			21.82	●			31.34	●			40.87	●			50.39	●			98.02	●		
	12.29	●			23.39	●			32.92	●			44.04	●			63.09	●			107.54	●		
	13.87	●			26.57	●			36.09	●			45.36	●			66.27	●			110.72	●		
	18.64	●			27.5	●			37.69	●			47.22	●	●		72.62	●			129.77	●		
5.33	37.47	●			46.99	●	●		88.27	●			94.62	●										
	40.64		●		62.87	●			91.44	●			253.37	●										

O'RING - SERIE NO STANDARD

d (mm)		S (mm)		MATERIAL		d (mm)		S (mm)		MATERIAL		d (mm)		S (mm)		MATERIAL		d (mm)		S (mm)		MATERIAL		d (mm)		S (mm)		MATERIAL			
d (mm)	S (mm)	N	S	d (mm)	S (mm)	N	S	d (mm)	S (mm)	N	S	d (mm)	S (mm)	N	S	d (mm)	S (mm)	N	S	d (mm)	S (mm)	N	S	d (mm)	S (mm)	N	S	d (mm)	S (mm)	N	S
2.7	1.2	●		12	3		●	21	1.5	●		31.55	3.72		●	42.2	3	●		60	4	●		90	3	●					
4	1	●		12.5	1.5	●		21	3	●		31.5	3.2	●		43	4		●	60	5	●		91	1.8	●					
4	1.5	●		13.1	1.3	●		22.1	3.6	●		32	3	●		44	2	●		61.8	3	●		94	3	●					
4.47	1.42	●		13.5	3	●		22.2	3.5	●		33.5	4.2	●		44	3	●		62	3.5	●		101	4	●					
4.5	1	●		14	2	●		22.5	2.5	●		34	3	●	●	45	2.5	●		63	3	●		102.5	94.5	●					
5.98	1.99	●		14	2.5		●	22.5	3	●		34.2	2.5	●		45	3	●		63.5	3		●	102.99	3.2	●					
6	2	●		14	3	●	●	23	3	●		35	3.5	●		45	4	●		64	3	●		110	3	●					
6.07	1.63	●		16	2	●		25	4	●		35	4		●	45.2	4		●	65	2.35		●	110	4.5	●					
7	4.5	●		16	2.5	●		26.2	3	●		35.3	3	●		46	3	●		70	3	●		112	4	●					
7.3	2.4	●		16	4		●	28	2	●		36	3	●		46.2	1.9	●		74	3	●		114.5	5	●					
8	1.5	●		16.5	3		●	28	4		●	36.5	3.2	●		46.3	3	●		74	3.35	●		115	2		●				
8	2.4	●		17	2.2	●		28.12	3.5	●		37	3	●		47	4	●		75	3	●		119	3	●					
9	2	●		17.5	6	●		28.2	2.5	●		37.47	3	●		47.3	2	●		76	2.5	●		122	5	●					
9.7	4	●		18	3	●		28.2	5	●		38	3	●		48	4	●		79	1.8	●	●	152	6	●					
10	2.5	●		19.18	2.46	●		29.2	3	●		39	3	●	●	50	4	●		79.5	3		●	168	3.5	●					
10	2.5		●	19.25	2.9	●		30	3.5	●		40	3	●		53.5	3	●		80	3	●		212.15	3	●					
11	2.5		●	20	2	●		30.2	3	●		40	5	●		55	2	●		82	3.5	●		320	8	●					
11.3	2.4	●		20	2.5	●		30.5	3.5	●		42	3	●		56.4	2	●		85	3	●									
12	2.5	●		20	4	●		30.5	3.8	●		42	4	●		58	2	●		85.5	3.35	●									

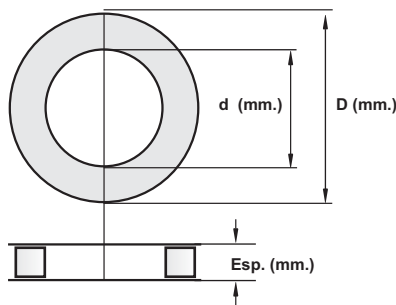

- > Diámetro interior d (mm)
- > Diámetro exterior D (mm)
- > Sección S (mm)
- > Diámetro interno d (mm)
- > Diámetro externo D (mm)
- > Corte S (mm)
- > Inner diameter d (mm)
- > Outer diameter D (mm)
- > Section S (mm)

ANILLOS

d (mm)	D (mm)	S (mm)	Mat.	d (mm)	D (mm)	S (mm)	Mat.	d (mm)	D (mm)	S (mm)	Mat.	d (mm)	D (mm)	S (mm)	Mat.	d (mm)	D (mm)	S (mm)	Mat.	d (mm)	D (mm)	S (mm)	Mat.
6	3	3	N	10	6	1	N	15	11	3	N	33	22	8	N	46	34	2	N	73	65	5	N
8	4	1	N	15	6	1	N	14,5	11,5	4	N	30	24	3,9	N	46,5	38,5	4	N	82	73	9,7	N
13,8	5	7,8	N	13,8	6,4	8	N	30	15,5	12	N	21	35	13	N	56,5	66,5	6	N	91	82,2	4,7	N
9	5	9,5	N	7,2	11	6	N	24	17	9	N	47,5	41,5	7	N	57	42	3	N	104,2	95	3	N



taranto



Retenes Taranto. Un sello de garantía

El permanente desafío que presenta la evolución de los motores de combustión actuales para asegurar el sellado de sus componentes requiere del desarrollo y aplicación de tecnología moderna y eficiente en la fabricación de los retenes. La constante actividad de nuestro Departamento de Ingeniería, aplicada al desarrollo e investigación de nuevos materiales y componentes para lograr la mejor performance de nuestros productos, acompañada de la realización de ensayos de vida y exigentes pruebas específicas que garantizan el perfecto desempeño en los distintos medios funcionales y la utilización de modernas técnicas de diseño aplicada a la construcción de nuevos labios y perfiles hidrodinámicos, permite ofrecer al mercado productos que superan las necesidades de estanqueidad del motor.



1 - NUEVOS PERFILES

Facilita el montaje y asegura el agarre.

2 - POSICION PREFERENCIAL DEL LABIO

Permite trabajar el labio en posiciones no utilizadas del eje.

3 - MODERNOS DISEÑOS

Permite trabajar el labio en una parte del eje no utilizable hasta el momento.









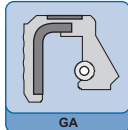
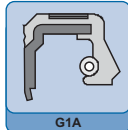
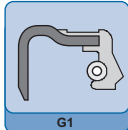
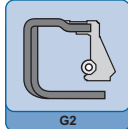

RETENES - MATERIALES Oil Seal - Materials

	ASTM D1418	ISO 1629	TARANTO	TEMPERATURA TEMPERATURE
<p>SILICONA Material para aplicaciones de baja y alta temperatura, muy usado en motores de elevada exigencia y en transmisiones automáticas. No recomendada para aceites EP (Extrema Presión).</p> <p>SILICONE Material para aplicação em baixas e altas temperaturas, muito usado em motores de elevada exigência. Não é recomendada para óleos EP (Extrema Pressão).</p> <p>SILICONE Material for low and high temperature applications, highly recommended for engines and automatic transmission. It should not be used for EP oils (Extreme Pressure).</p>	VMQ	MVQ	S	-50°C a +180°C
<p>NITRÍLICO Es el material más comúnmente utilizado en sellado para aplicaciones generales. Buena resistencia a la abrasión y a la acción de aceites y grasas minerales.</p> <p>NITRILICA É o material mais comumente utilizado em vedação para aplicações gerais. Tem boa resistência ao atrito e a ação de óleos e graxas minerais.</p> <p>NITRILE It is the most commonly used sealing material for general applications. Good resistance to abrasion and to mineral oils and greases.</p>	NBR	NBR	N	-35°C a +110°C
<p>POLIACRÍLICO Recomendado para aplicaciones en motor y especialmente en transmisión con aceites EP. Deformación permanente más elevada.</p> <p>POLIACRÍLICO Recomendado para aplicações em motores e especialmente em transmissões com óleo EP. Deformação permanente mais elevada.</p> <p>ACRYLIC (POLYACRYLATE) Highly recommended for engines and especially in transmission with EP oils. Higher permanent set.</p>	ACM	ACM	P	-30°C a +150°C
<p>FLUORELASTOMERO Compuesto para altas exigencias con mejor resistencia a altas temperaturas y ataques químicos. Ofrece duración en servicio muy superior, pero a costo más elevado.</p> <p>FLUORELASTÓMERO Composto para altas exigências com melhor resistência a altas temperaturas e ataques químicos. Oferece duração em serviço muito superior, porém a um custo mais elevado.</p> <p>FLUORELASTOMERS Compound for high demands with better resistance to high temperatures and chemical aggressions. It grants a better duration in service but at higher costs.</p>	FKM	FPM	V	-30°C a +200°C
<p>POLITETRAFLUORETILENO Usos de elevada temperatura, gran ataque químico y severas condiciones de fricción.</p> <p>POLITETRAFLUORETILENO Utilizado em ambientes com altas temperaturas e elevado ataque químico, e em condições severas de atrito.</p> <p>POLYTETRAFLUORETHYLENE High temperature uses, great chemical attack and severe friction conditions.</p>	PTFE	PTFE	T	-80°C a +250°C
<p>FLUORELASTOMERO / POLITETRAFLUORETILEO Compuesto especial desarrollado por Taranto (Viflón®) para altas exigencias de temperatura, ataque químico e importantes condiciones de fricción. Es la elección ideal entre el tipo V y el tipo T.</p> <p>FLUROELASTOMER / POLITETRAFLUORETILENO Composto especial desenvolvido pela Taranto (Viflón®) para os requisitos de alta temperatura, gravura e importantes condições por atrito. É a escolha ideal entre o tipo V e T -type</p> <p>FLUROELASTOMER / POLYTETRAFLUROETHYLENE Special compound developed by Taranto (Viflón®) or high temperature requirements, chemical attack and important conditions of friction . Is the ideal choice between the V type and T-type</p>	FKM PTFE	FKM PTFE	T	-30°C a +200°C

DESCRIPCIÓN - TIPOS DE RETENTES RADIALES

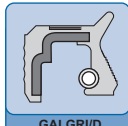
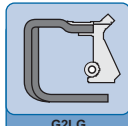
Types oil seal - description

GA	Goma armada Exterior borracha Rubber case	G1A	Exterior goma metal Exterior metal borracha Outer rubber metal	G1	Exterior metal Exterior metálico Outer metal			
G2	Blindado Blindado Armoured	RI	Roscado izquierdo Rosca esquerda Left Threaded	RD	Roscado derecho Rosca direita Right Threaded			
SR	Sin resorte Sem mola Without spring	LG	Labio guardapolvo Láblio guarda-pó Dust Lip	HD	Hélice derecha Hélice direita Right helix			
HI	Hélice izquierda Hélice esquerda Left helix	ESP	Especial Especial Special	BI	Bidireccional Bidireccional Bi-directional			

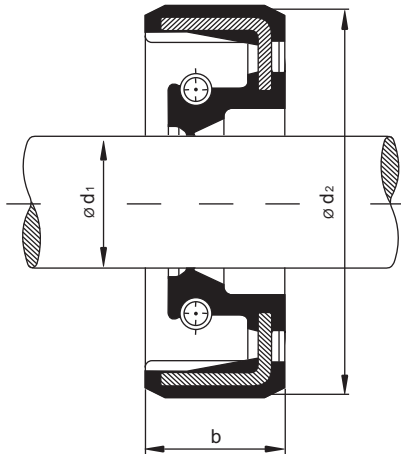

- > Diámetro de Eje (d1)
- > Altura (b)
- > Alojamiento (d2)
- > Diâmetro do eixo (d1)
- > Altura (b)
- > Alojamento (d2)
- > Shaft diameter (d1)
- > Height housing (b)
- > Housing Bore (d2)

RETENES POR DIÁMETRO DE EJE					MATERIAL							MATERIAL										
CODIGO	EJE	ALOJAM.	ALT.	TIPO	N	S	P	V	T	Vf		CODIGO	EJE	ALOJAM.	ALT.	TIPO	N	S	P	V	T	Vf
R300347	7,90	16,00	6	GA	●							R230448	24,00	46,50	10	ESP		●				
R550614	8,10	14,30	4,2	U'RING				●				R250156	25,00	35,00	7	GA	●					
R550447	8,40	16,00	6,5	GA	●							R280415	25,00	40,00	8	GALG-BI	●					
R460215	9,50	16,00	4	GALGSR	●							R560113	25,00	42,00	7	GALGHD		●	●			
R550515	12,70	25,40	6,5	GAHI			●					R240415	26,00	42,00	8	G1ALGHD		●	●			
R223543	13,00	21,90	5/6,5	ESP-GADUO						●		R550660	26,00	42,00	8/17	EGALG	●					
R240048	13,00	26,00	7	GALG	●							R350315	26,00	45,00	10	G1	●					
R550051	13,00	26,00	9	GALG	●							R902115	26,00	49,0	9.5/11	ESP	●					
R250148	14,00	24,00	7	ESP	●							R270515	27,00	37,00	7	G1ALGHD			●			
R550451	15,00	26,00	7	GALG	●							R860012	27,00	39,50	7	GALGHD		●				
R300748	15,50	28,00	6/15	ESP	●							R231313	27,00	42,00	8	G1ALGHD			●			
R300048	15,70	23,81	4,76	GA SR	●							R470813	27,00	47,00	7	GALGHD			●			
R550648	16,00	22,80	4,8	GA	●							R550951	27,95	56,00	10	GALGHD		●				
R250448	16,00	24,60	9/20	ESP	●							R570351	27,95	70,00	10	GALGHD		●				
R450348	17,00	23,00	7	ESP	●							R320013	28,00	38,00	7	GALGHD		●	●			
R910514	17,00	28,00	7	GALG		●						R300351	28,00	40,00	8	GALGHD	●					
R910515	17,00	28,00	7	GALG		●						R570913	28,00	42,00	5	GALGHD			●			
R300749	17,00	28,00	7/10	GALGHD	●							R222313	28,00	42,00	7	GALGHI			●			
R550450	17,00	28,00	7/13	GAHD	●							R450557	28,00	45,00	8	GAHD		●				
R280215	17,50	32,00	6	GALGHD	●		●	●				R580013	28,00	47,00	5,5	GALGHD			●			
R220649	20,00	35,00	7/10,5	GAHD			●					R250151	28,00	47,00	8	GAHD	●					
R240949	21,00	32,00	7,5	G1LGHD	●							R510012	28,50	41,25	6	GALGHD			●			
R232430	21,00	35,22	9	ESP			●					R300051	28,58	41,20	6,2	G1HD	●					
R300751	21,50	40,00	7	GAHD			●					R250660-1	29,80	50,00	10/13,5	G1ALGHD			●			
R250652	22,00	35,00	8	GALG	●							R250660	29,80	52,00	10/13,5	G1ALGHI			●			
R250451	22,00	40,00	7/8,5	G2LGHD	●							R200849	29,90	45,00	7	G1HD			●			
R560114	22,00	45,00	7	GALGHI			●	●				R460760	29,90	47,00	11,3	GALGRD c/f		●				
R220349	22,10	40,00	12/17	GALGHD	●							R550615	30,00	40,00	7	GAHD	●	●	●			
R400213	22,22	34,92	6,35	GA	●							R860013	30,00	40,00	7	GA-B		●				
R400215	22,22	35,70	9,52	ESP-RD	●							R260113	30,00	42,00	7	GALGHD			●	●		
R260251	22,80	40,00	7/8,5	G2LGHD			●					R550413	30,00	42,00	8	GAHI	●	●				
R250457	23,00	37,00	13,5	ESP			●					R150012	30,00	42,04	8	GALGHD	●					
R550550	24,00	36,00	8/12	GAHD	●							R260112	30,00	43,00	8	G1ALGHD		●	●			

c/f Con Feltro/With Felt











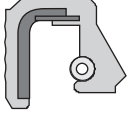

RETENES POR DIÁMETRO DE EJE					MATERIAL												MATERIAL						
CODIGO	EJE	ALOJAM.	ALT.	TIPO	N	S	P	V	T	VF	CODIGO	EJE	ALOJAM.	ALT.	TIPO	N	S	P	V	T	VF		
R900913	30,00	44,00	7	GALGHD		●					R810012	35,00	62,00	7	GALG-BI	●							
R270614	30,00	44,00	8	GALGHI				●			R920012	36,00	49,00	7	GALGD		●						
R240713	30,00	45,00	8	GALGHD	●	●					R460213	36,00	50,00	8	GALGHD			●	●				
R250255	30,00	45,00	8	GA	●						R550055	36,00	54,00	7	G1	●							
R950512	30,00	46,00	8	GALGHD	●	●					R550460	36,00	54,00	8/11	E-GALG c/f*	●							
R570614	30,00	47,00	6	GAHI			●				R250257	36,00	68,00	10/13	GAHD	●							
R260914	30,00	47,00	7	G1ALGHD			●	●			R310812	36,51	52,48	8	GALGHD			●					
R340312	30,00	50,00	7,5	GALGRD				●			R230513	37,00	47,00	10	GALGHD				●				
R250413	30,00	52,00	7	GALGRD			●				R520912	37,00	50,00	6	GALGHD		●						
R260313	30,00	52,00	7	G1ALGHD	●	●	●				R302212	37,00	50,00	8	GALGHD					●			
R252012	31,00	41,00	7	G1ALGHD				●			R230413	38,00	48,00	8	GALGHD	●							
R270615	31,00	41,00	7	GALGHD				●			R452113	38,00	50,00	6	GALGHD					●			
R240012	31,00	50,00	8	GALGHD			●	●			R242513	38,00	50,00	8	-					●			
R272213	31,00	55,00	7	G1ALGHD				●			R290912	38,00	50,00	8	G1ALGHD					●			
R200051	31,68	44,45	6,35	G1HD	●						R320913	38,00	52,00	6	GALGHD					●			
R230512	32,00	42,00	7	G1ALGHD			●	●			R250155	38,00	52,00	10	G1	●							
R570512	32,00	44,00	6	GALGHD				●			R200859	38,00	52,00	8,5/2,5	ESP-GALG	●							
R230412	32,00	45,00	6,5	GALGRD			●				R300755	38,00	58,50	7	GA-BI	●							
R910613	32,00	46,00	6	GALGHD				●			R300050	38,10	60,30	12,5/19	ESP-RI	●							
R220412	32,00	47,00	10	GALGHD			●	●			R310256	38,10	63,55	12,7	GA	●							
R230113	32,00	47,00	10	GALG-BI			●	●			R970012	38,50	58,00	11	GALGHD	●	●						
R950012	32,00	48,00	7	GALGHD	●	●					R210912	39,68	58,73	9,46	GALGRD	●							
R920014	32,00	50,00	8	GALGHD			●				R300057	39,68	80,29	7/16	ESP-RD	●							
R450351	32,00	50,00	10	GAHD			●				R540057	39,68	80,29	7/16	ESP-RD	●							
R550012	32,00	50,00	10	GALGHD	●						R340112	39,95	62,00	7,4	GALGHD					●			
R250050	32,00	56,00	10	GALGHI	●						R280212	40,00	52,00	6	GALGHD			●	●				
R250256	32,54	51,43	9,92	GA	●						R420613	40,00	52,00	7	GALGHD					●			
R320912	33,00	47,00	5	GALGHD				●			R902112	40,00	52,00	7	GALGHD		●						
R300255	33,33	57,15	12,7	G2	●						R220455	40,00	52,00	7,5	GALG	●							
R900912	34,00	48,00	7	GALGHD			●				R240455	40,00	52,00	8,5	E-GALG	●							
R550455	34,00	52,00	7,5	GA	●						R320055	40,00	55,00	6,5	G1SRLG	●							
R220150	34,92	56,00	10,7	GALGRI	●						R270713	40,00	55,00	7	G1ALGHD					●			
R420612	35,00	45,00	7	GALGHD			●				R300358	40,00	55,00	8	GALG	●							
R570612	35,00	47,00	5,5	GALGHD				●			R971512	40,00	55,00	8	GALGHD					●			
R550613	35,00	47,00	7	GAHD			●	●			R310760	40,00	55,00	9	G1LG-BI	●							
R240013	35,00	48,00	7	GALGHD			●	●			R920013	40,00	55,00	9	GALGHD					●			
R300350	35,00	49,70	12,7	G1LGRI	●						R250412	40,00	56,00	7	GALGRD	●	●						
R470013	35,00	50,00	7	GALG-BI			●	●			R260312	40,00	56,00	7	G1ALGHD	●	●	●					
R520915	35,00	50,00	8	GALG	●						R450350	40,00	58,00	10	GAHI	●	●						
R910513	35,00	50,00	8	GALGHD		●					R460760-1	40,00	58,00	10	GALG-BI c/f*					●			
R950712	35,00	50,00	8		●						R250012	40,00	60,00	10	GAHD	●							
R550412	35,00	50,00	9	GALGHD	●	●	●				R470014	40,00	62,00	7	GALGHI						●		
R520212	35,00	52,00	8	GALGHD			●				R340115	40,00	62,00	7,4	GALGHD			●					
R520215	35,00	52,00	8	GALGHD			●				PR320015	40,00	-	-	PORTA						●		
R250158	35,00	52,00	8,8	G1	●						R220359	40,10	52,00	9	ESP-GALG	●							
R240960	35,00	54,00	10/15	G1ALG-BI	●						R320313	42,00	53,00	7	GALGHD			●	●				

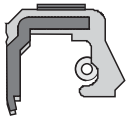
c/f Con Filtro/With Felt

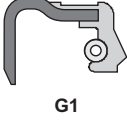
RETENES RADIALES

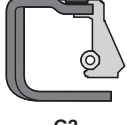
Oil Seal Catalog



RETENES POR DIÁMETRO DE EJE					M A T E R I A L							M A T E R I A L										
CODIGO	EJE	ALOJAM.	ALT.	TIPO	N	S	P	V	T	Vf		CODIGO	EJE	ALOJAM.	ALT.	TIPO	N	S	P	V	T	Vf
R570412	42,00	54,00	6	GALGHD			•	•				R470015	47,50	62,00	7	GALGHI						•
R250112	42,00	56,00	7	ESP-G1	•		•					R330313	47,60	66,70	11,3	GALGRD						•
R250455	42,00	56,00	7	GA	•							R340512	47,62	65,07	7,95	G1LGHD						•
R300612	42,00	56,00	7	GAHD	•		•	•				R302715	47,63	63,50	8,5/12,3	GALGHD						•
R910612	42,00	60,00	7	GALGHD	•	•						R300212	47,65	65,05	11,83	G1AHD	•	•				
R450412-1	42,00	60,00	8	GALGHD			•					R310252	47,70	73,10	12,7	ESP	•					
R450012	42,00	60,00	10	GALGHD	•		•					R320712	48,00	65,00	7,85	GALGHD	•					
R460212	42,00	62,00	7	GALGHD		•	•	•				R150011	48,00	65,00	10	GALGHI	•					
R800312	42,00	65,00	10	GALGHD			•	•				R950212	48,00	65,00	10	GAHD		•	•			
R460712	42,00	66,00	8	GALGHD				•				R520812	48,00	68,00	11	GALGHD		•				
R500012	42,00	68,00	10/16	GALGHD	•							R900012	48,00	70,00	9	GALGHD	•					
R700912	42,00	72,00	10	GALG	•							R902312	48,00	70,00	9	GALGHD		•				
R300312	43,41	56,02	9,3	ESP-G1LGHD	•		•					R970312	48,00	70,00	12	GALGHD	•					
R910512	44,00	60,00	7	GALGHI		•						R220356	48,00	72,00	7/8,5	GALG	•					
R950312	44,00	60,00	7	GALGHD	•	•	•					R550555	48,70	58,00	8,5	ESP	•					
R220158	44,45	53,97	4,67	GA	•							R460255	48,90	63,00	10,8/12,8	E-GALG-BI				•		
R510412	44,45	57,15	9,5	GALGHD		•						R210012	49,20	65,09	12,7	GALGHD	•	•				
R300012	44,45	60,30	11,11	G1AHD	•		•					R300258-1	49,22	63,62	7,26	ESP	•					
R540912	44,45	61,95	9,52	GAHD	•							R300455	50,00	65,00	9	ESP-G1	•					
R220112	44,45	63,50	9,52	GAHD	•		•					R240712	50,00	65,00	10	-	•					
R200012	44,47	61,19	9,57	G1LGHD	•		•					R550612	50,00	68,00	10	GALGRD			•	•		
R220355	44,50	62,00	11	GALG-BI	•							R270113	50,00	70,00	10	GALGRD			•	•		
R570613	45,00	57,00	6,5	GALGHD			•	•				R300258	50,80	66,60	6,5	G1SRLG	•					
R510812	45,00	57,15	9,5	GALGHD				•				R550458	50,80	69,85	9,53	GA	•					
R250258	45,00	59,00	10	G1	•							R410912	50,90	69,80	9,5	GAHD	•					
R420614	45,00	60,00	7	GALGHI				•				R900812	51,00	70,00	11	GALGHD					•	
R450412-2	45,00	60,00	7	GALGHD			•					R520312	52,00	68,00	9,5	GALGHD						•
R450158	45,00	60,00	10	GA	•							R450055-1	52,00	75,00	12	GA	•					
R450412	45,00	60,00	10	GALGHD	•		•					R540012	52,38	81,02	11	GALGHD	•					
R450055	45,00	62,00	12	GA	•							R450355	53,00	79,00	10	ESP	•					
R220358	45,00	65,00	8	GALG	•							R220012	53,97	80,96	14,68	E-GARD	•					
R250212	45,00	65,00	10	E-GAHD	•							R242512	54,00	82,00	11,45	-					•	
R351112	45,00	67,00	8	GALGHD						•		R270612	55,00	68,00	8	GALGHD						•
R922512	45,00	68,00	7	-		•						R241515	55,00	70,00	8	GALGHI						•
R950412	45,00	68,00	12	GALG	•							R270115	55,00	70,00	10	GALGHD						•
R500112	45,00	68,00	10/16	GALGHD	•							R300759	55,00	70,00	6/10	ESP	•					
R800513	45,00	75,00	10	G1ALGHI						•		R700612	55,00	72,00	10	GALGHD	•					
R301712	45,00	63,8/77,6	10,8	G1ALGHD		•						R810151	55,00	75,00	9	G1LGHD						•
R360112	45,00	74,5/79,5	12/14,5	E-RD						•		R510512	55,00	81,00	15,8	G1LGHD				•	•	
R272030	45,70	23,30	10,5	ESP						•		R150211	55,95	69,1/70,7	10	GAHI	•					
R902512	46,00	58,00	7	GALGHD		•	•					R500412	56,00	80,00	10	GAHD					•	
R310658	46,00	65,50	7/8,5	G1LG-BI	•							R430012	57,00	71,00	9	GALGRD						•
R250757	46,00	78,00	10	G1LGHD	•							R950511	57,00	77,00	10	GALGHI		•	•			
R550459	46,43	69,78	12,3	GALG	•							R850012	57,15	76,20	9,5	GALGHD	•	•				
R430013	46,70	62,00	9	GALGHD						•		R220013	57,15	80,98	11,5	GALGRD						•
R340712	47,00	63,40	8,8	GALGHD						•		R420112	57,30	76,20	12,7	GALGHD	•					
R340412	47,00	65/80	15	E-G1LGHD			•					R430015	57,50	74,00	8	GASRLG	•					

c/f Con Filtro/With Felt



RETENES POR DIÁMETRO DE EJE					M A T E R I A L												M A T E R I A L						
CODIGO	EJE	ALOJAM.	ALT.	TIPO	N	S	P	V	T	VF	CODIGO	EJE	ALOJAM.	ALT.	TIPO	N	S	P	V	T	VF		
R950011	58,00	74,00	9,5	GALGHI		●					R970011	75,00	100,00	13	GALGRI		●	●					
R310458	58,95	76,00	9	G1SRLG	●						R700212	75,00	100,00	17	GALGHD	●							
R550655	60,00	70,00	9,1	ESP	●						R200811	75,90	95,00	11,3	GALGH			●					
R500211-1	60,00	75,00	5	EXPAN		●					R241911	76,00	92,00	10	GALGRI		●	●					
R581812	60,00	75,00	7	GALGRD				●			R220111	76,20	95,22	9,32	GARI	●							
R990011	60,00	75,00	8	GALGHI			●				R510411	76,20	95,25	9,5	GALGHD		●						
R950711	60,00	78,00	10	GALGHI			●				R271511	78,00	100,00	9	GALGSRRI				●	●			
R940011	60,00	80,00	8	GALGHI		●					R460511	78,00	100,00	10	G1ALGHI				●				
R330012	60,30	82,50	11	G1HD			●				R310412	78,00	100,00	13	GALGHD			●	●				
R400012	60,32	79,36	9,5	GALGHD	●		●	●			R351012	78,00	104,00	11	GASRRD C/F			●					
R320111	60,45	76,18	10	GALGHI				●			R860011	79,00	126,00	1,25	ESPFI			●					
R260950	63,00	69,50	11	ESP			●				PR320011	79,00	-	16	PORTA				●				
R870012	63,50	79,50	9	G1ALGRD				●	●	●	R330311	79,30	99,00	9,8	GALGHI				●				
R200011	64,00	78,00	12	2 PARTES			●				PR340111	79,30	-	-	PORTA				●	●			
R200011-1	64,00	78,00	12	2 PARTES		●					R300611	79,38	95,25	11,11	GAHI			●	●				
R200011-2	64,00	78,00	12	EXPAN		●					R520811	80,00	96,00	9	GALGRI		●	●					
R450411-1	64,00	80,00	5	EXPAN		●					R910511	80,00	96,00	9	GALGHI		●						
R250111	64,00	80,00	8	G1ALGHI	●		●	●			R950611	80,00	96,00	9	GALGRI			●					
R250811	64,00	80,00	8	G1ALGHD	●		●				R240411	80,00	98,00	10	G1ALGRI			●	●				
R700112	64,00	85,00	12	GAHD	●						R570011	80,00	100,00	8	GALGRI				●				
R470012	64,00	88,00	6	GALGHD				●			R250211	80,00	100,00	10	GALGHI	●		●					
PR260911	64,00	-	-	PORTA				●			R810115	80,00	100,00	12	G1LG-BI				●				
R650112	65,00	85,00	13	G1ALGHD			●				R950411	80,00	100,00	12	GALGHI		●						
R350212	65,00	90,00	15	G1LGHD			●				R550811	80,00	100,00	13	GARI			●	●				
R330312	66,67	85,70	10	GALGRD				●			R902311	80,00	100,00	13	GALGHI		●	●					
R320012	66,67	89,30	10	GALGRD			●	●			R970311	80,00	105,00	13	GALGHI		●	●					
R330212	66,70	88,80	11/12,5	G1ALGHD	●		●				PR320911	80,00	-	-	PORTA					●			
R350957	68,00	85,00	10	GALGHD				●			PR340314	80,00	-	-	PORTA			●					
R360057	68,00	85,00	10	GALG	●						R300711	82,00	105,00	12	GALGHI			●					
R581813	70,00	85,00	7	GALGRD				●			R902111	84,00	104,00	11	GALGRI			●					
R260011	70,00	85,00	8	G1ALGHI			●				R903411	84,00	117,00	8,5	GALGRI				●				
R570511	70,00	86,00	8	GALGHI			●				R560111	85,00	105,00	8	GALGRI			●	●				
R971511	70,00	88,00	11	-			●				R910611	85,00	105,00	10	GAHI	●	●						
R220311	70,00	90,00	10	GAHI			●				R560611	85,00	105,00	11	GALGRI				●				
R270112	70,00	90,00	10	GALGHD			●	●			R220411	85,00	105,00	12	GALGRI			●	●	●			
R550411	70,00	90,00	10	GALGHI	●		●				PR221711	85,00	-	-	PORTA				●	●			
R800012	70,00	90,00	15	G1LGHD			●				PR230211	85,00	-	-	PORTA				●	●			
PR270112	70,00	-	-	PORTA				●			PR231211	85,00	-	-	PORTA						●		
R950311	72,00	96,00	9	GALGRI		●	●				R300911	85,70	100,00	5,5	E-GARI	●		●					
R270511	74,00	88,00	8	G1ALGRI			●				R300011	85,70	102,62	9,73	GAHI			●					
R260111	74,00	90,00	10	G1ALGRI			●	●			R240311	85,90	104,00	11	GALGRI			●	●				
PR270511-1	74,00	-	-	PORTA				●			R300911-1	86,00	100,00	5,5	EXPAN		●						
PR270711	74,00	-	-	PORTA				●			R280211	87,00	100,00	8,5	GALGRI				●				
PR271911	74,00	-	-	PORTA				●			R320311	88,00	108,00	10	GALGRI				●				
R870212	75,00	93,00	9/10	G1ALGRD				●	●		R301711	88,00	108,00	11	GAHI			●					
R350858	75,00	95,00	13	GALG	●						PR302211	88,00	-	-	PORTA						●		
R350612	75,00	100,00	12	G1LGHDI			●				R420611	88,90	105,00	9,5	GARI			●					

c/f Con Fieltro/With Felt



RETENES POR DIÁMETRO DE EJE					M A T E R I A L							TIPO	M A T E R I A L										
CODIGO	EJE	ALOJAM.	ALT.	TIPO	N	S	P	V	T	Vf	CODIGO		EJE	ALOJAM.	ALT.	N	S	P	V	T	Vf		
R240211	90,00	104,00	11	GALGRI		•	•					R351011	115,00	140,00	13	G1ASRR1 c/f		•					
R350211-1	90,00	106,00	7,5	EXPAN		•						R650111	115,00	140,00	16	G1ALGHI		•					
R460211	90,00	110,00	7	GALGRI		•						R210011	118,00	143,00	13	GARI	•						
R971811	90,00	110,00	8,5	-		•						R360011	120,00	140,00	13	G1ALGRI				•			
R460211-1	90,00	110,00	10	GALGRI						•		R350455	120,00	145,00	15	G2LG	•						
R550611	90,00	110,00	13	GALGRI						•		R850011	120,65	146,07	12,7	GALGRI c/pista		•					
R270111	90,00	115,00	13	GALGHI								R330011	122,20	140,80	12	GALGHI				•			
R500411	90,00	120,00	12	G1ALGHI						•		R350955	125,00	150,00	15	G2LG-BI	•						
R520911	91,00	111,00	9	GALGHI		•						R870011	130,00	150,00	12/13	GALGRI					•	•	•
R330511	91,00	111,00	10	G1ALGRI						•		R330411	130,00	160,00	12	G1ALGRI					•		
R300411	91,50	106,50	5,5	ESP-GARI	•							R810111	130,00	160,00	15	GALGRI					•		
R321811	92,00	106,00	5	2 PARTES						•		R400211	133,35	158,75	11/13	GALGRI				•	•		
R302511	92,00	107,58	9,5	G1ARI						•		R800511	140,00	165,00	13	G1ALGRI					•		
R300311	92,00	108,00	9,8	GAHI						•		R650411	150,00	172,00	18,3	GAHI		•					
R581811	93,00	108,00	7	GALGRI						•		R800055	180,00	200,00	12	G1ALG	•						
R351111	93,00	114,00	13	GALGHI						•		EL MISMO RETEN FABRICADO EN DISTINTOS CAUCHOS											
PR270911	93,00	-	-	PORTA						•	<p>Aconsejamos el uso prioritario de los materiales recomendados en las aplicaciones y referencias originales de nuestro catálogo.</p> <p>No obstante con el propósito de ofrecer un mejor servicio, atendiendo las preferencias de diferentes mercados y clientes, algunos retenes de nuestro catálogo se fabrican también en materiales alternativos.</p> <p>Si el material prioritario recomendado no se ajusta a sus necesidades, le sugerimos que consulten la lista de retenes TARANTO, clasificado por dimensiones, para verificar si la misma pieza puede ser suministrada en otro caucho.</p>												
PR351211	93,00	-	-	PORTA						•	O MESMO RETENTOR FABRICADO EM DIFERENTES MATERIAIS												
R321111	95,00	114,50	9,5	GALGHI		•						<p>Recomendamos o uso prioritário dos compostos indicados nas aplicações e referências originais do nosso catálogo.</p> <p>No entanto, com o intuito de oferecer melhor serviço, atendendo as preferências de diferentes mercados e clientes, alguns retentores de nosso catálogo são fabricados em materiais alternativos.</p> <p>Se o material prioritário recomendado não se ajusta a suas necessidades sugerimos que consultem a lista de retentores TARANTO classificados por dimensão para verificar se a mesma peça pode ser fornecida em outra borracha.</p>											
R340911	95,00	114,50	11	GALGRI						•		THE SAME OIL SEAL MANUFACTURED IN VARIOUS RUBBERS											
R922211	95,00	115,00	9,5	GALGHI		•						<p>It is suggested, as a priority, the use of the materials recommended in the applications and original references (OEM) of our catalogue.</p> <p>However, in order to offer a better service and to assist the preferences of different markets and customers, some oil seals of our catalogue are also manufactured with alternative materials.</p> <p>If the recommended material does not meet your requirements, you should consult TARANTO oil seal list classified by dimensions, to confirm if the same piece can be supplied in another rubber.</p>											
R280111	95,00	115,00	12	GALGRI						•		DISEÑO											
R351155	95,00	115,00	13	GALG-BI	•							<p>La constante mejora de nuestros retenes produjo cambios en el diseño tales como:</p> <ul style="list-style-type: none"> ⓐ Modificación de diseño externo: Facilita el montaje y asegura el agarre. ⓑ Labios desplazados: Permiten trabajar el labio en una parte del eje no utilizada hasta el momento. ⓒ Diseño de labio: Se potenció el uso de la rosca como sello hidrodinámico. 											
R242111	95,00	115,00	12,5	GALGHI		•	•						PROJETO										
R240711	95,00	118,00	8,5	GALGHI		•							<p>A constante melhora de nossos retentores produziu mudanças de projeto como:</p> <ul style="list-style-type: none"> ⓐ Modificação de desenho externo: Facilita a montagem e assegura o alojamento. ⓑ Lábios deslocados: Permite que o lábio trabalhe em uma parte do eixo ainda não utilizada. ⓒ Desenho do lábio: Aumentou a utilização da rosca como vedação hidrodinâmica. 										
R350258	95,00	130,00	13	G2LG		•							DESIGN										
R570611	98,00	110,00	7	GALGRI						•			<p>The steady improvement of our oil seals produced changes in design such as:</p> <ul style="list-style-type: none"> ⓐ Changes in external design: Making assembly easier and ensuring housing. ⓑ Displaced Lips: Allowing the lip to work in a part of shaft not used so far. ⓒ Lip Design: The use of thread as hydrodynamic seal was potentialized. 										
R470011	98,00	120,00	7	GALGHI						•			DISEÑO										
R290711	99,00	114,00	11	GALGRI						•			<p>La constante mejora de nuestros retenes produjo cambios en el diseño tales como:</p> <ul style="list-style-type: none"> ⓐ Modificación de diseño externo: Facilita el montaje y asegura el agarre. ⓑ Labios desplazados: Permiten trabajar el labio en una parte del eje no utilizada hasta el momento. ⓒ Diseño de labio: Se potenció el uso de la rosca como sello hidrodinámico. 										
PR430011	99,45	-	-	PORTA						•			PROJETO										
R270311	100,00	118,00	10	GALGHI						•			<p>A constante melhora de nossos retentores produziu mudanças de projeto como:</p> <ul style="list-style-type: none"> ⓐ Modificação de desenho externo: Facilita a montagem e assegura o alojamento. ⓑ Lábios deslocados: Permite que o lábio trabalhe em uma parte do eixo ainda não utilizada. ⓒ Desenho do lábio: Aumentou a utilização da rosca como vedação hidrodinâmica. 										
R350458	100,00	120,00	13	G2LG	•								DESIGN										
R650912	100,00	120,00	15	GALGHD						•			<p>The steady improvement of our oil seals produced changes in design such as:</p> <ul style="list-style-type: none"> ⓐ Changes in external design: Making assembly easier and ensuring housing. ⓑ Displaced Lips: Allowing the lip to work in a part of shaft not used so far. ⓒ Lip Design: The use of thread as hydrodynamic seal was potentialized. 										
R350958	100,00	125,00	12	G1A-BI	•								DISEÑO										
R360812	100,00	130,00	11	GALGRD						•			<p>La constante mejora de nuestros retenes produjo cambios en el diseño tales como:</p> <ul style="list-style-type: none"> ⓐ Modificación de diseño externo: Facilita el montaje y asegura el agarre. ⓑ Labios desplazados: Permiten trabajar el labio en una parte del eje no utilizada hasta el momento. ⓒ Diseño de labio: Se potenció el uso de la rosca como sello hidrodinámico. 										
R930111	100,00	135/140	15	GALGHI		•							PROJETO										
R900811	101,57	125,00	13	GALGHI		•							<p>A constante melhora de nossos retentores produziu mudanças de projeto como:</p> <ul style="list-style-type: none"> ⓐ Modificação de desenho externo: Facilita a montagem e assegura o alojamento. ⓑ Lábios deslocados: Permite que o lábio trabalhe em uma parte do eixo ainda não utilizada. ⓒ Desenho do lábio: Aumentou a utilização da rosca como vedação hidrodinâmica. 										
R850511	101,60	127,00	7,94	GALGHI						•			DESIGN										
R850512	101,60	127,00	12,7	GALGHD						•			<p>The steady improvement of our oil seals produced changes in design such as:</p> <ul style="list-style-type: none"> ⓐ Changes in external design: Making assembly easier and ensuring housing. ⓑ Displaced Lips: Allowing the lip to work in a part of shaft not used so far. ⓒ Lip Design: The use of thread as hydrodynamic seal was potentialized. 										
R360012	105,00	130,00	12	G1ALGRD						•			DISEÑO										
R310411	110,00	130,00	13	GALGHI						•			<p>La constante mejora de nuestros retenes produjo cambios en el diseño tales como:</p> <ul style="list-style-type: none"> ⓐ Modificación de diseño externo: Facilita el montaje y asegura el agarre. ⓑ Labios desplazados: Permiten trabajar el labio en una parte del eje no utilizada hasta el momento. ⓒ Diseño de labio: Se potenció el uso de la rosca como sello hidrodinámico. 										
R350255	110,00	140,00	13	G2LG	•								PROJETO										
R650212	110,00	140,00	16	GALGHD		•							<p>A constante melhora de nossos retentores produziu mudanças de projeto como:</p> <ul style="list-style-type: none"> ⓐ Modificação de desenho externo: Facilita a montagem e assegura o alojamento. ⓑ Lábios deslocados: Permite que o lábio trabalhe em uma parte do eixo ainda não utilizada. ⓒ Desenho do lábio: Aumentou a utilização da rosca como vedação hidrodinâmica. 										
R200311	112,50	130,00	11	G1ALGRI						•			DESIGN										
R360811	113,00	140,00	12	GALGRI						•			<p>The steady improvement of our oil seals produced changes in design such as:</p> <ul style="list-style-type: none"> ⓐ Changes in external design: Making assembly easier and ensuring housing. ⓑ Displaced Lips: Allowing the lip to work in a part of shaft not used so far. ⓒ Lip Design: The use of thread as hydrodynamic seal was potentialized. 										
R800311	114,00	135,00	13	G1ALGRI						•			DISEÑO										
PR270111-1	114,00	-	-	PORTA						•			<p>La constante mejora de nuestros retenes produjo cambios en el diseño tales como:</p> <ul style="list-style-type: none"> ⓐ Modificación de diseño externo: Facilita el montaje y asegura el agarre. ⓑ Labios desplazados: Permiten trabajar el labio en una parte del eje no utilizada hasta el momento. ⓒ Diseño de labio: Se potenció el uso de la rosca como sello hidrodinámico. 										

c/f Con Feltro/With Felt

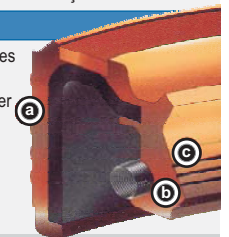



taranto



HAB12075

BARRA DE EXTENSION CON LUZ LED

Práctica barra de extensión con encastre de 1/2 x 75mm. Para trabajar en lugares oscuros. Superbrillante y potente luz led con baterías alojadas en el interior de la barra.



KIT HAK12-38 Taranto.

Práctico Juego de llaves especiales para motor.

- ▶ Contiene todos los tipos y medidas de herramientas necesarios para el trabajo sobre vehículos de última generación.
- ▶ Posee tubos y tubos con punta de alta resistencia son fabricados en acero cromo vanadio con doble cromado y moleteados para mejorar el agarre.
- ▶ Encastre de 12.7 mm. Con espacio para bola de retención.



HERRAMIENTAS ESPECIALES PARA MOTOR

Set of Special Automotive Tools



KIT HAK12-38



FORMACION DEL CODIGO DE ARTICULO

H	A	T	5	5	0	5	5
LINEA		TIPO	MEDIDA		LARGO HERRAMIENTA		

LINEA	TIPOS DE LLAVE
HA: Herramienta de ajuste	D: Tubo Estriado S: Tubo Hexagonal B: Barra de Extención E: Tubo Torx Hembra N: Tubo con Punta Estriado R: Tubo con Punta Ribe T: Tubo con Punta Torx

KIT HAK 12-38

38 PIEZAS ENCASTRE DE 12.7mm (1/2")

CANT.	CONTENIDO
9	TUBOS HEXAGONALES 12,13,14,15,17,19,21,24,27mm
5	TUBOS ESTRIADOS 10,12,14,17,19mm
6	TUBOS TORX HEMBRA E10,E12,E14,E16,E18,E20
5	TUBOS CON PUNTA TORX T55X55,T55X100,T60X55,T60X100,T70X100mm
5	TUBOS CON PUNTA ESTRIADA M9X100,M10X55,M10X100,M12X55,M12X100mm
3	TUBOS CON PUNTA RIBE R10X168,R12X63,R14X63mm.
5	TUBOS CON PUNTA HEXAGONAL H8X55,H8X90,H8X120,H10X55,H10X140mm.

TUBOS HEXAGONALES	CODIGO	DESCRIPCION	D (mm)	L (mm)
	HAS12038	HEXAGONAL 12mm	22	38
	HAS13038	HEXAGONAL 13mm	22	38
	HAS14038	HEXAGONAL 14mm	22	38
	HAS15038	HEXAGONAL 15mm	22	38
	HAS17038	HEXAGONAL 17mm	24	38
	HAS19038	HEXAGONAL 19mm	26	38
	HAS21038	HEXAGONAL 21mm	28	38
	HAS24038	HEXAGONAL 24mm	32	38
	HAS27038	HEXAGONAL 27mm	36	42

TUBOS ESTRIADOS	CODIGO	DESCRIPCION	D (mm)	L (mm)
	HAD10038	ESTRIADO 10mm	22	38
	HAD12038	ESTRIADO 12mm	22	38
	HAD14038	ESTRIADO 14mm	22	38
	HAD17038	ESTRIADO 17mm	24	38
	HAD19038	ESTRIADO 19mm	26	38

TUBOS TORX	CODIGO	DESCRIPCION	D (mm)	L (mm)
	HAE10038	TORX Hembra E10	23	38
	HAE12038	TORX Hembra E12	23	38
	HAE14038	TORX Hembra E14	23	38
	HAE16038	TORX Hembra E16	23	38
	HAE18038	TORX Hembra E18	23	38
	HAE20038	TORX Hembra E20	24	38

TUBOS CON PUNTA TORX	CODIGO	DESCRIPCION	D (mm)	L (mm)
	HAT55055	Punta TORX T55 x 55mm	24	55
	HAT55100	Punta TORX T55 x 100mm	24	100
	HAT60055	Punta TORX T60 x 55mm	24	55
	HAT60100	Punta TORX T60 x 100mm	24	100
	HAT70100	Punta TORX T70 x 100mm	24	100

TUBOS CON PUNTA ESTRIADA	CODIGO	DESCRIPCION	D (mm)	L (mm)
	HAN09100	Punta ESTRIADA M9 x 100mm	24	100
	HAN10055	Punta ESTRIADA M10 x 55mm	24	55
	HAN10100	Punta ESTRIADA M10 x 100mm	24	100
	HAN12055	Punta ESTRIADA M9 x 100mm	24	55
	HAN12100	Punta ESTRIADA M12 x 55mm	24	100

TUBOS CON PUNTA RIBE	CODIGO	DESCRIPCION	D (mm)	L (mm)
	HAR10168	Punta RIBE R10 x 168mm	24	168
	HAR12063	Punta RIBE R12 x 63mm	24	63
	HAR14063	Punta RIBE R14 x 63mm	24	63

TUBOS CON PUNTA HEXAGONAL	CODIGO	DESCRIPCION	D (mm)	L (mm)
	HAH08055	Punta HEXAGONAL H8 x 55mm	24	55
	HAH08090	Punta HEXAGONAL H8 x 90mm	24	90
	HAH08120	Punta HEXAGONAL H8 x 120mm	24	120
	HAH10055	Punta HEXAGONAL H10 x 55mm	24	55
	HAH10140	Punta HEXAGONAL H10 x 140mm	24	140

BARRA DE EXTENSION CON LUZ LED ENCASTRE 12.7mm (1/2")

TUBOS CON PUNTA RIBE	CODIGO	DESCRIPCION	D (mm)	L (mm)
	HAB12075	Barra de extensión 1/2"x 75 mm con luz led	12.7	75

Práctica barra de extensión con encastrado de 1/2" x 75mm. Para trabajar en lugares oscuros!

Super brillante y potente luz LED con baterías alojadas en el interior de la barra.

3 baterías de repuesto incluidas en el kit.



taranto



KIT HAK639512-111 Taranto.

Práctico Juego de llaves combinadas para Taller.

- Contiene 111 Tubos y llaves SmarDriv encastre 1/4", 3/8" y 1/2"
- Forjados en acero especial, niquelados y cromados anticorrosión.
- Diseñados y fabricados con un rango de medidas acorde a las necesidades de cada pieza.





taranto

Luego de meses de investigación y ensayos en motores hemos logrado esta nueva versión de junta combinando la sellabilidad de materiales fibrosos y el cierre de cámara de combustión de juntas Multiláminas (MLS).

NUEVA TECNOLOGIA



Aro de fuego de acero sólido 4 mm. de apoyo en zona crítica.

✓ Mayor coeficiente de disipación térmica

— Aro de fuego solapado.
Junta de baja resistencia térmica.



Nueva Tecnología Taranto.

Las juntas están diseñadas para superar las exigencias de presión y temperatura que producen los motores de última generación.

- Micro y macro sellado en zonas críticas.
- Compensa los espesores rectificadas, con el objetivo de no alterar la relación de compresión.
- Aro de fuego de acero sólido que garantiza el excelente sellado de la cámara de combustión en las zonas críticas.

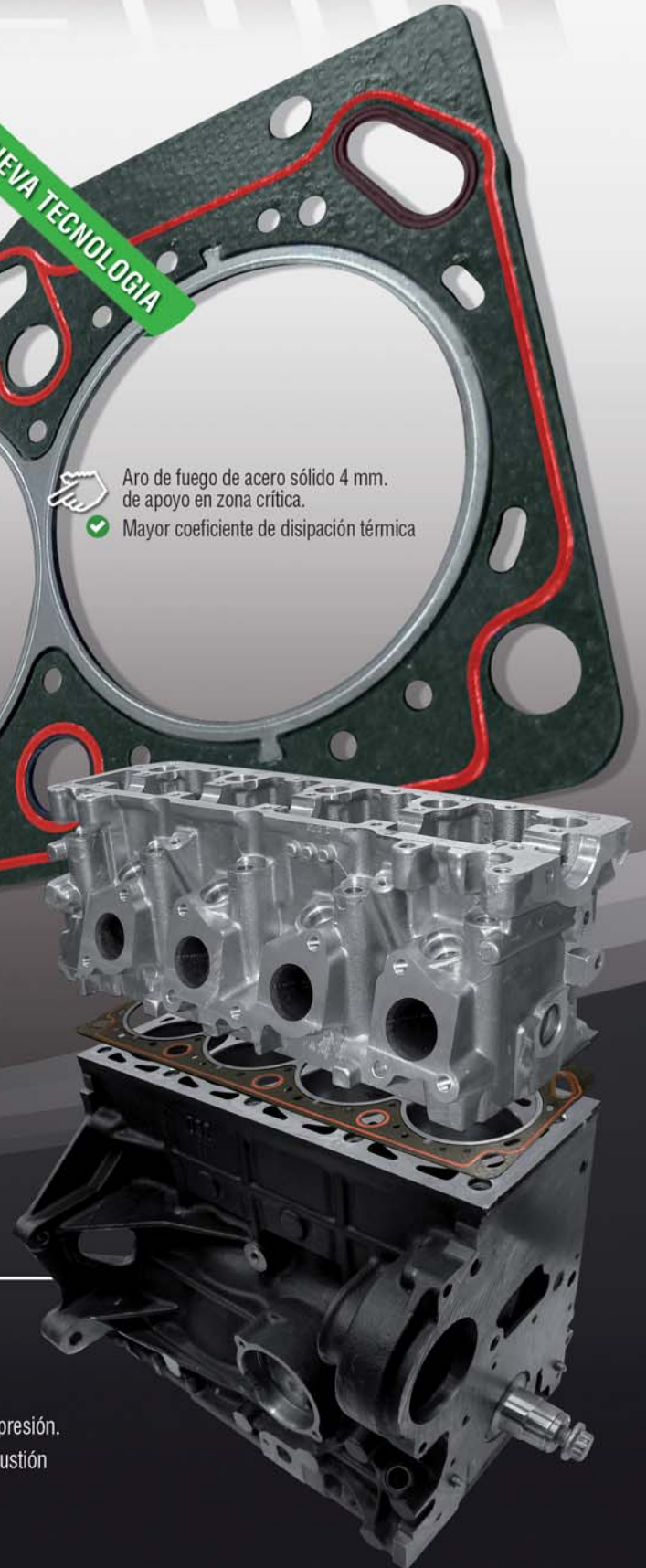



MOTORES NAFTA - DIESEL

950207 	Código	Ø	⊗	Kit Bulón	Modelo
	950207	81.5	1.60	B980000 (HAE14038)	320 - 520 1977/82 - 323i 1977/82 1990cc. M20 122HP Ø80 2315cc. M20 142HP Ø80 (950200-R) pág. 02
980007 	Código	Ø	⊗	Kit Bulón	Modelo
	980007	81.0	1.80	B980000 (HAE14038)	520i 1982/90 - 1987/90, 320i 1982/93 - 1988/91 - 323i 1982/86 1990cc. M20 (206KA) 125/129HP - 206EE 130HP Ø80 2315cc. M20 (236EE) 139/150HP Ø80 (980000-R) pág. 03
980207 	Código	Ø	⊗	Kit Bulón	Modelo
	980207-2M 980207-3M	81.0 81.0	1.68 1.87	B980200 (HAE14038)	325 TD 1991/92 - 525 TDS 1990/92 2498cc. M51 (256T1/T1L) 115/143HP Ø80 - DIESEL (980201-R) pág. 04
980507 	Código	Ø	⊗	Kit Bulón	Modelo
	980507-1M 980507-2M 980507-3M	81.0 81.0 81.0	1.55 1.68 1.87	B980500 (HAE14038)	324 D 1985/90 - 524 D 1986/87 - 324 TD 1987/93 - 524 TD 1982/87 2443cc. M21 (246D/DA/TB/TA) 86/115HP Ø80 DIESEL (980501-R) pág. 05
981107 	Código	Ø	⊗	Kit Bulón	Modelo
	981107-2M 981107-3M	81.0 81.0	1.68 1.87	B981100 (HAE14038)	318TDS 1994/99 - 318 Compact TDS 1995/00 1670cc. M41D (174T1) 90HP Ø80 - DIESEL (981101-R) pág. 06
981207 	Código	Ø	⊗	Kit Bulón	Modelo
	981207-2M 981207-3M	81.0 81.0	1.68 1.87	B980200 (HAE14038)	725 TDS 1995/... - 325 TDS - 525 TDS - 325 TD - 525 TD 1994/... 2498cc. M51 (256T1/T1L) 115/143HP Ø80 - DIESEL (981201-R) pág. 07
981307 - 981308 	Código	Ø	⊗	Kit Bulón	Modelo
	981307 981308	78.0 78.0	0.95 0.65	B981300 (HAS15038)	One Coupe (Mini R50) 2000/01 - Cooper Coupe (Mini R50) 2000/01 1598cc. W10B16A 90/116HP Ø77 (981300-R) pág. 08
981407 	Código	Ø	⊗	Kit Bulón	Modelo
	981407	86.0	1.70		1500 1962/86 - 316 (E21) 1975/84 - 1500 - 1502 - 1600 (E6) 1602 - 1600 Ti (E10) - 1600 GT 1499cc. M10 B15 70HP Ø84 1573cc. M10 B16 73/84/90/103HP Ø84 (981400-R) pág. 09
981508 	Código	Ø	⊗	Kit Bulón	Modelo
	981508	85.5	1.30	B981500	523i 2005/... - 323i, 325i, 325xi, X3i, Z4i 2006/... 2497cc. N52B25A (DOHC) 24V 177/218HP Ø82 (981500-R MLS) pág. 10
982008 	Código	Ø	⊗	Kit Bulón	Modelo
	982008	84.5	0.45		316i, 316ci Coupe, 316ti 2000/... 318ti, 318ci Cabrio, 318ci Coupe 2000/... - 320is 2001/..., 318ci Cabrio, 318ci Coupe, 318ti 2003/... - X3i 2003/... - Z4i 2004/... 1796cc. N42B18A (VALVETRONIC) - N40B16A - 115/116HP Ø84 1995cc. N42B20A (VALVETRONIC) - N46B20A - N46B20C - 143HP Ø84 (DOHC) 16V (982000-R MLS) pág. 11

BMW



Motor/Engine	Cm³	HP	Ø
M20	1990	122	80
M20	2315	142	80

BMW: 320 - 520 - 323i 1977/82



Nº OE	Descripción/Description	Mat.	Ref.
	Jgo. de juntas para motor		950200-R
11121738609	Junta tapa cilindros Ø 81.5 \pm 1.60	NFT	1 950207
11121726478	Jgo. tornillos tapa cilindros (HAE14038)		B980000
11121730271	Junta tapa de válvulas	NH	1 950210
11131730234	Junta para cárter	NH	1 950211
11141720903	Tapa distribución	NB	1 950212
	Tapa bomba de agua	NB	1 950214
11621723877	Jgo. múltiple escape (6)	NFT	1 950216
11611730743	Jgo. múltiple admisión (5)	NB	1 950217
18111245429	Salida de escape	NFT	2 950218
	Acople bomba de agua	NB	1 950219
	Bomba aceite	NB	1 950227
	Bomba nafta	NB	2 950228
	Brida bomba aceite	NB	1 950229
	Inyección	NB	1 950230
	Inyección	NB	1 950231
07119963130	Arandela tapón cárter A 12 x 15.5 x 1.5 A	AL	
	Kit de retenes completo		R950200
11349059172	Jgo. retén válvulas (12)	V	1 R950210V
11401706999	Retén bancada 90 x 110 x 13	V	1 R550611V
11141275466	Retén distribución 48 x 65 x 10	P	1 R950212P
11121285609	Retén árbol levas 38 x 50 x 6	V	1 R452113V

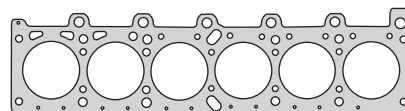

950207

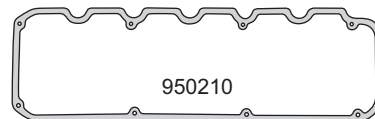

950210

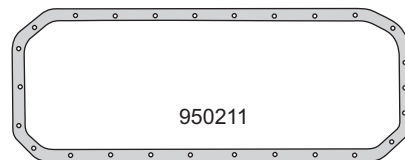

950211

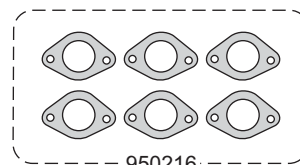

950216

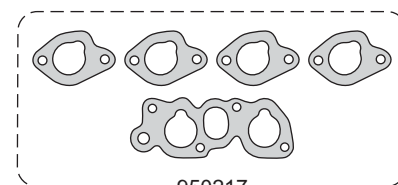

950217

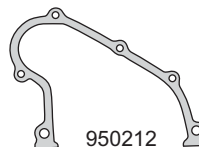

950212

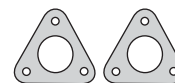

950218



950214



950219



950227



950229



950231



950228



950230



A 12 x 15.5 x 1.5 A



R550611V



R950212P



R452113V

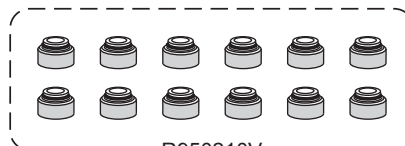

R950210V

BMW



Motor/Engine	Cm³	HP	Ø
M20 (206KA)	1990	125/129	80
M20 (236EE)	2315	139/150	80

BMW: 520i 1982/90 - 1987/90
320i 1982/93 - 1988/91
323i E30 1982/86



Nº OE	Descripción/Description	Mat.	Ref.
	Jgo. de juntas para motor		● 980000-R
11131738611	Junta tapa cilindros Ø 81 ± 1.80	NFT	1 980007
11121726478	Jgo. tornillos tapa cilindros (HAE14038)		B980000
11121730271	Junta tapa de válvulas	NFT	1 950210
11131730234	Junta para cárter	CG	1 950211
11141720903	Tapa distribución	NH	1 950212
	Tapa bomba de agua	NH	1 950214
11621723877	Jgo. múltiple escape (2)	NFT	1 980016
11611730743	Jgo. múltiple admisión (5)	NH	1 950217
18111245429	Salida de escape	AC	2 950218
	Acople bomba de agua	NH	1 950219
	Bomba aceite	NH	950227
	Bomba nafta	NH	2 950228
	Porta retén bancada trasera	CB	1 980529
	Brida bomba aceite	NH	1 950229
	Junta	CB	1 980030
	Junta	CB	1 980031
	Inyección	NH	950230
	Inyección	NH	950231
	Tapón goma	GS	4 950240
	Arandela A 13.3 x 10 x 0.86 A	AL	1
	Arandela A 14 x 17.8 x 1.36 A	AL	4
	Arandela A 14 x 17.8 x 1.40 C	CU	2
	Arandela A 15.3 x 12.3 x 1.36 A	AL	3
	Arandela A 27 x 22 x 1.36 A	AL	1
	O´ring G 60 x 3.5	GS	1
	O´ring G 55 x 2	GS	1
	O´ring G 40 x 3	GS	2
	O´ring G 40 x 4	GS	1
	O´ring G 27 x 2.4	GS	1
	O´ring G 27 x 3	GS	2
	O´ring G 7.5 x 3.6	GS	13
	O´ring G 6.5 x 2	GS	1
	Kit de retenes completo		R950200
11349059172	Jgo. retén válvulas (12)	V	1 R950210V
11401706999	Retén bancada 90 x 110 x 13	V	1 R550611V
11141275466	Retén distribución 48 x 65 x 10	P	1 R950212P
11121285609	Retén árbol levas 38 x 50 x 6	V	2 R452113V

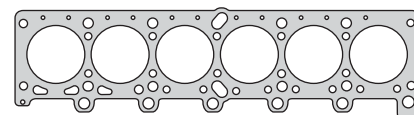

980007

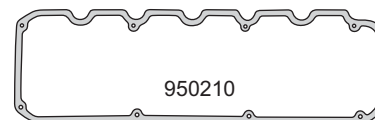

950210

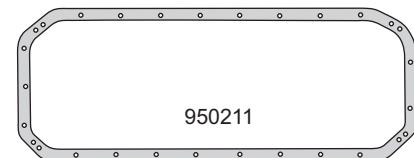

950211

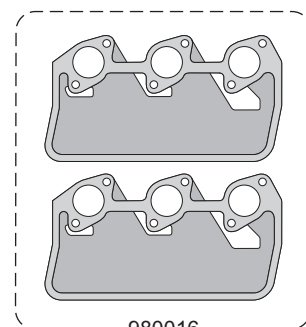

980016

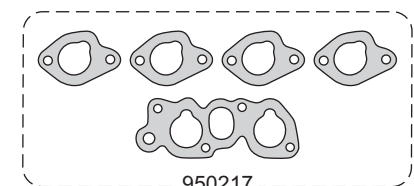

950217

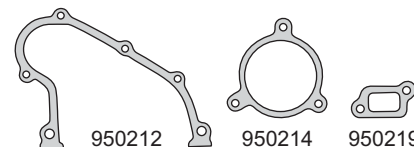

950212

950214

950219



980529

950229

950218

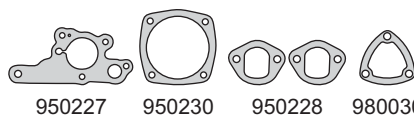

950227

950230

950228

980030



980031

950240

950231



R452113V



R550611V



R950212P

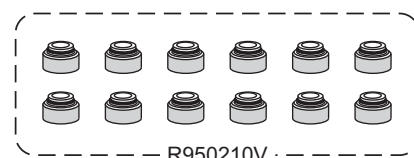

R950210V

BMW



Motor/Engine	Cm³	HP	Ø
M51 (256T1)	2498	115	80
M51 (256T1-L)	2498	143	80

BMW: 325 TD 1991/92 - 525 TDS 1990/92

DIESEL



Nº OE	Descripción/Description	Mat.	Ref.
	Jgo. de juntas para motor		980201-R
11129065445	Jgo. de juntas superior	●	980295
11122245483	Junta tapa cilindros Ø 81 \pm 1.68	NFT	980207-2M
11122245427	Junta tapa cilindros Ø 81 \pm 1.87	NFT	980207-3M
11129067790	Jgo. tornillos tapa cilindros (HAE14038)		B980200
11122244398	Junta tapa válvulas	GS 1	980210
11139065503	Junta para cárter	NH 1	980211
	Placa distribución	NH 1	980213
11622243782	Jgo. múltiple escape con reflector (5)	CHA 1	980216
11612244391	Jgo. múltiple admisión (6)	NH 1	980217
	Salida de escape	NFT 1	980218
	Base filtro aceite a bomba	NH 1	980227
	Junta porta retén trasero	CB 1	980229
	Acople bomba aceite	NH 1	980230
	Retorno aceite a turbo	SLS 1	980231
	Cierre distribución	GS 1	980232
	O'ring G 69.5 x 3.5	GS 2	2
	O'ring G 11.6 x 1.59	GS 2	2
	O'ring G 12.6 x 1.6	GS 4	4
	O'ring G 70 x 5	GS	1
	O'ring G 50 x 2	GS	1
	O'ring G 4.5 x 1.4	GS	1
	O'ring G 14.6 x 3	GS	1
	O'ring G 18 x 2	GS	1
	O'ring G 9 x 2	GS	1
	O'ring G 19 x 2.5	GS	1
	O'ring G 35 x 3	GS	1
	O'ring G 28 x 2	GS	1
	Arandela A 15.25 x 12.4 x 1.3 A	AL 4	4
	Arandela A 14.9 x 12.2 x 1.4 C	CU 2	2
	Arandela A 23.8 x 20 x 1.3 C	CU	1
	Arandela A 12.8 x 10 x 1 C	CU	4
	Arandela A 17.8 x 14 x 1.3 A	AL	1
	Arandela A 15.8 x 10.2 x 1 A	AL	1
07119963130	Arandela tapón cárter A 12 x 15.5 x 1.5 A	AL	1
	Kit de retenes completo		R980200
11349064457	Jgo. retén válvulas (12)	V 1	R980210V
11141706999	Retén bancada 90 x 110 x 10	V 1	R980211V
11141275466	Retén distribución 48 x 65 x 10	V 1	R950212V

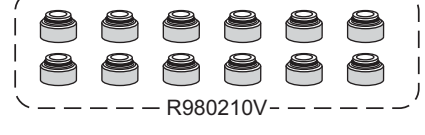
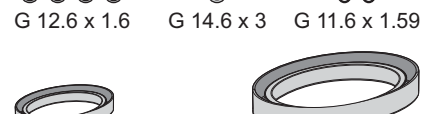
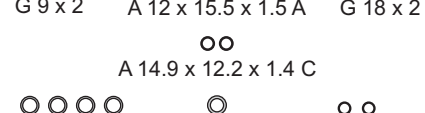
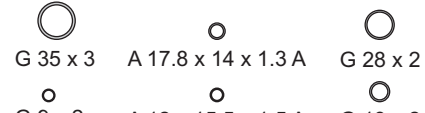
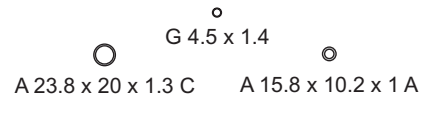
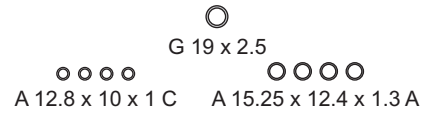
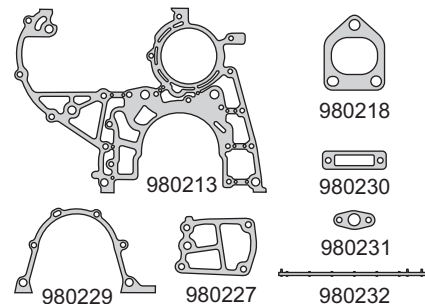
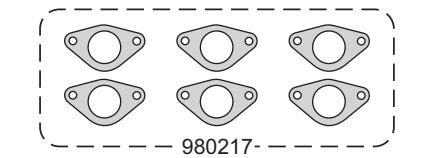
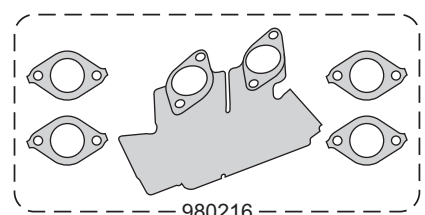
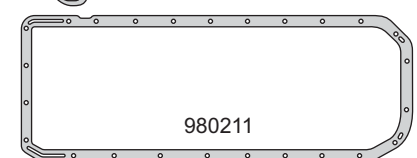
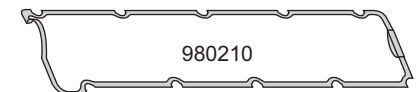
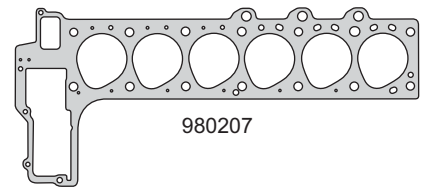

BMW



Motor/Engine	Cm³	HP	Ø
M21 (246D/DA)	2443	86	80
M21 (246TB/TA)	2443	115	80

BMW: 324 D 1985/90 - 524 D 1986/87
324 TD 1987/93 - 524 TD 1982/87

DIESEL



Nº OE	Descripción/Description	Mat.	Ref.
	Jgo. de juntas para motor		980501-R
11122243879	Jgo. de juntas superior		980595
11122244727	Junta tapa cilindros Ø 81 \pm 1.55	NFT	980507-1M
11122244728	Junta tapa cilindros Ø 81 \pm 1.68	NFT	980507-2M
11122244729	Junta tapa cilindros Ø 81 \pm 1.87	NFT	980507-3M
11122243143	Jgo. tornillos tapa cilindros (HAE14038)		B980500
11121285973	Junta tapa válvulas	GS 1 1	980510
11131730234	Junta para cárter	NH 1 1	980511
11141720903	Tapa distribución	CB 1 1	950212
	Bomba de agua	NH 1 1	950214
	Bomba de agua	NH 1 1	980514
11622243866	Jgo. múltiple escape (6)	FCH 1 1	980216
11612243867	Jgo. múltiple admisión (3)	NH 1 1	980517
	Termostato	NH 1 1	980519
	Base filtro aceite a bomba	CB 1 1	980527
	Porta retén bancada trasera	CB 1 1	980529
	Base termostato	NH 1 1	980530
	Junta	NH 1 1	980531
	Retorno agua	CB 1 1	980532
	Chupador aceite	CB 1 1	980533
	Retorno aceite a turbo	CB 1 1	980539
07119963130	Arandela tapón cárter A 12 x 15.5 x 1.5 A	AL 1 1	
	Arandela A 17.85 x 14 x 1.36 A	AL 3 3	
	Arandela A 22 x 16 x 1.35 C	CU 1 1	
	Arandela A 20 x 16 x 1.3 C	CU 2 2	
	Arandela A 20 x 14.3 x 1.5 A	AL 4 4	
	Arandela A 14.9 x 12.2 x 1.5 C	CU 2 2	
	Arandela A 15.25 x 12 x 1.3 A	AL 6 6	
	Arandela A 17.8 x 14 x 1.3 A	AL 6 6	
	Arandela A 19.8 x 16 x 1.3 C	CU 2 2	
	O'ring G 5 x 2	GS 2 2	
	O'ring G 36.5 x 30 x 3	GS 1 1	
	O'ring G 13.8 x 2	GS 1 1	
	O'ring G 28 x 4.72	GS 1 1	
	O'ring G 10 x 8	GS 1 1	
	O'ring G 60 x 3.5	GS 1 1	
	O'ring G 40 x 3.15	GS 1 1	
	O'ring G 102 x 4	GS 1 1	
	O'ring G 92 x 5.38	GS 1 1	
	Kit de retenes completo		R980500
11349059172	Jgo. retén válvulas (12)	V 1 1	R980510V
11141706999	Retén bancada 110 x 90 x 10	V 1 1	R980211V
11141275466	Retén distribución 48 x 65 x 10	V 1 1	R950212V
11121285609	Retén árbol de levas 38 x 50 x 7	V 2 2	R980513V

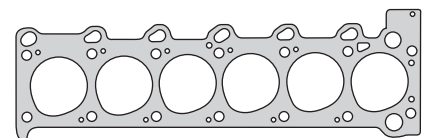

980507

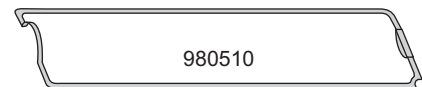

980510

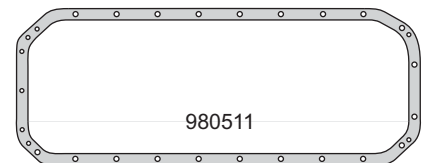

980511

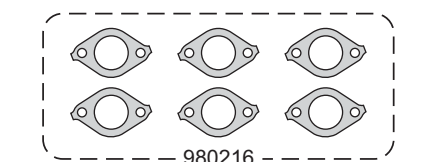

980216

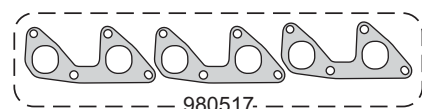

980517

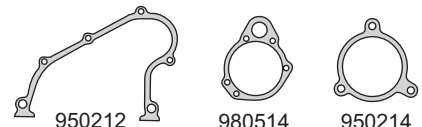

950212

980514

950214

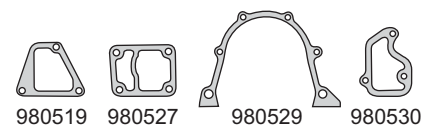

980519

980527

980529

980530



980539

980533

980531

980532

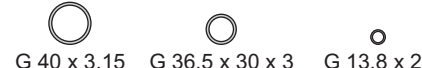

G 40 x 3.15

G 36.5 x 30 x 3

G 13.8 x 2



G 102 x 4

G 92 x 5.38

G 60 x 3.5

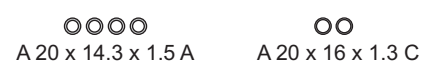

A 20 x 14.3 x 1.5 A

A 20 x 16 x 1.3 C

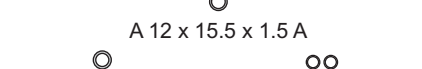

A 12 x 15.5 x 1.5 A

A 22 x 16 x 1.35 C

A 14.9 x 12.2 x 1.5 C



G 10 x 8

G 28 x 4.72

G 5 x 2



A 17.8 x 14 x 1.3 A

A 15.25 x 12 x 1.3 A



A 17.85 x 14 x 1.36 A

A 19.8 x 16 x 1.3 C



R980211V



R950212V



R980513V

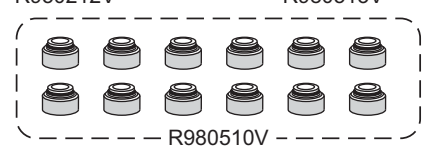

R980510V

BMW



Motor/Engine	Cm³	HP	Ø
M41D (174T1)	1670	90	80

BMW: 318TDS 1994/99
318 Compact TDS 1995/00

DIESEL



Nº OE	Descripción/Description	Mat.	Ref.
	Jgo. de juntas para motor		981101-R
11122246704	Jgo. de juntas superior	●	981195-2M
	Jgo. de juntas superior		981195-3M
11122246093	Junta tapa cilindros Ø 81 \pm 1.68	NFT 1	981107-2M
11122246092	Junta tapa cilindros Ø 81 \pm 1.87	NFT	981107-3M
11129067792	Jgo. tornillos tapa cilindros (HAE14038)		B981100
11122245599	Conj. junta tapa válvulas (7)	GS 1	981110
11139067655	Junta para cárter	GS 1	981111
	Tapa distribución	SLS 1	981112
11622245274	Jgo. múltiple escape con reflectores (3)	CHA 1	981115
11612245438/9	Jgo. múltiple admisión (5)	GS 1	981117
	Salida de escape	NFT 1	980218
	Brida	SLS 1	981132
11122245844	Arandelas tapa válvulas	CH/GS 6	981133
	Guarnición bomba de aceite	GS 1	981134
	Junta inspección distribución	SLS 1	981135
	Junta porta reten trasero motor	SLS 1	981136
	O´ring G 9.60 x 2.5	GS 2	
	O´ring G 9.20 x 2.2	GS 2	
	O´ring G 16.50 x 4	GS 2	
	O´ring G 9.48 x 2.38	GS 2	
	O´ring G 12.46 x 1.5	GS 2	
	O´ring G 60 x 3.5	GS 2	
	O´ring G 14.50 x 3	GS 1	
	O´ring G 63.5 x 2.54	GS 1	
	O´ring G 28.26 x 2	GS 1	
	O´ring G 36 x 3	GS 1	
	O´ring G 68 x 5.04	GS 1	
	Arandela A 14.4 x 18 x 1.5 A	AL 3	
	Arandela A 12.3 x 15.3 x 1.3 A	AL 2	
	Arandela A 10 x 12.9 x 1 C	CU 2	
	Arandela A 10 x 13.3 x 0.9 C	CU 2	
	Arandela A 12.4 x 16.8 x 1.3 C	CU 1	
	Arandela A 20.4 x 23.76 x 1.4 C	CU 1	
	Arandela A 14.3 x 17.8 x 1.4 A	AL 1	
	Kit de retenes completo		R981100
11342245151	Jgo. retén válvulas (8)	V 1	R981110V
11142245364	Retén bancada trasera 90 x 110 x 12	V 1	R981111V
11141274346	Retén distribución 48 x 65 x 10	V 1	R981112V
	Retén árbol de levas 42 x 66 x 6	V 1	R981113V

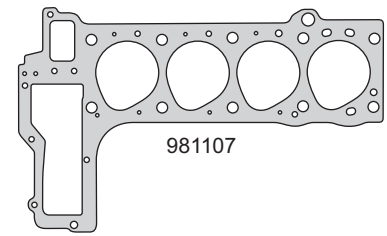

981107

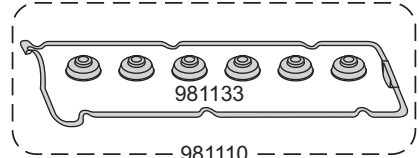

981133

981110

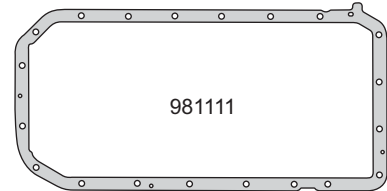

981111

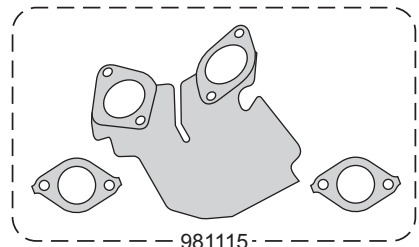

981115



G 43 x 39 x 2 G 60 x 56 x 2

981117

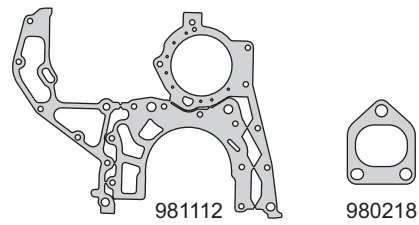

981112

980218

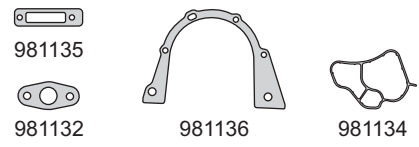

981135

981136

981134

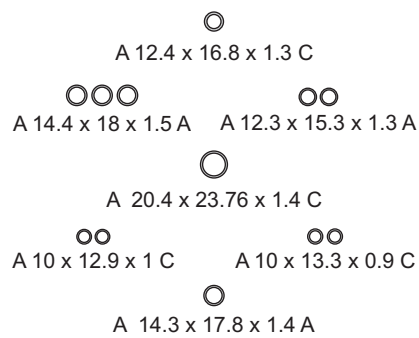

A 12.4 x 16.8 x 1.3 C

A 14.4 x 18 x 1.5 A A 12.3 x 15.3 x 1.3 A

A 20.4 x 23.76 x 1.4 C

A 10 x 12.9 x 1 C A 10 x 13.3 x 0.9 C

A 14.3 x 17.8 x 1.4 A

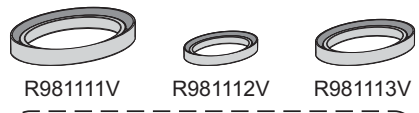

R981111V

R981112V

R981113V

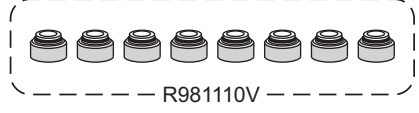

R981110V

BMW



Motor/Engine	Cm³	HP	Ø
U25TD/X25TD	2498	130	80
D256TM	2498	136	80
M51 (256T1)	2498	115/143	80
M51 (256T1-L)	2498	143	80

BMW: 725 TDS - 325 TD/TDS - 525 TD/TDS 1994/...

Opel: Omega B TD 1994/96

Rover: Range Rover Turbo 1994/02

DIESEL



Nº OE	Descripción/Description	Mat.	Ref.
	Jgo. de juntas para motor		981201-R
11122244328	Jgo. de juntas superior	●	981295-2M
	Jgo. de juntas superior		981295-3M
11122245483	Junta tapa cilindros Ø 81 \pm 1.68	NFT 1	981207-2M
11122245427	Junta tapa cilindros Ø 81 \pm 1.87	NFT	981207-3M
11129067790	Jgo. tornillos tapa cilindros (HAE14038)		B980200
11122244398	Junta tapa válvulas	GS 1	980210
11139066503	Junta para cárter	NH 1	981211
	Frente distribución	SLS 1	980213
11622246172	Jgo. multiple escape (5)	CHA 1	980216
11612244391	Jgo. multiple admisión (6)	NH 1	980217
	Salida de escape	NFT 1	980218
	Base filtro aceite a bomba	SLS 1	981227
	Porta retén bancada trasero	NH 1	981229
	Acople bomba aceite	SLS 1	981230
	Retorno aceite a turbo	SLS 1	981231
	Cierre distribución	GS 1	980232
	O'ring G 61.26 x 3.89	GS 2	2
	O'ring G 9.2 x 2.62	GS 2	2
	O'ring G 12.6 x 1.60	GS 4	4
	O'ring G 120 x 3.6	GS	1
	O'ring G 70 x 5	GS	1
	O'ring G 35 x 3	GS	1
	O'ring G 14.6 x 3	GS	1
	O'ring G 19 x 2.5	GS	1
	O'ring G 4.5 x 1.4	GS	1
	O'ring G 9.4 x 2	GS	1
	O'ring G 65 x 2.63	GS	1
	O'ring G 28 x 2	GS	2
	Arandela A 15.25 x 12.4 x 1.3 A	AL 4	4
	Arandela A 15 x 12.20 x 1.43 C	CU 2	2
	Arandela A 23.8 x 20 x 1.3 C	CU	1
	Arandela A 13.8 x 10.4 x 0.8 C	CU	4
	Arandela A 15 x 10.2 x 1 A	AL	2
	Arandela A 18 x 14.3 x 1.5 A	AL	1
	Kit de retenes completo		R980200
11349064457	Jgo. retén válvulas (12)	V 1	R980210V
11141706999	Retén bancada 90 x 110 x 10	V 1	R980211V
11141275466	Retén distribución 48 x 65 x 10	V 1	R950212V

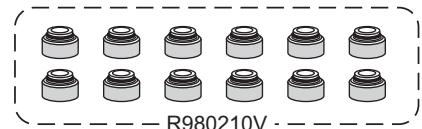
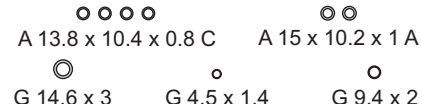
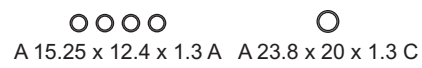
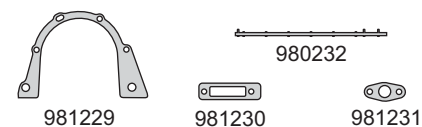
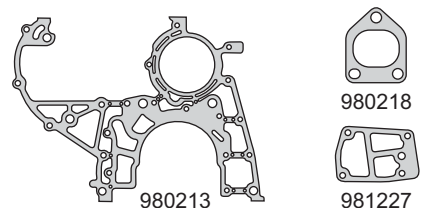
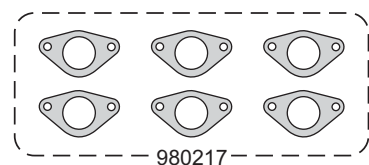
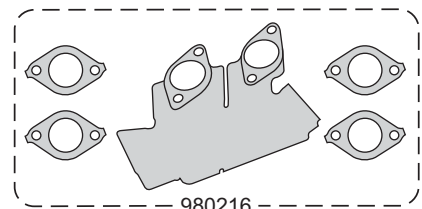
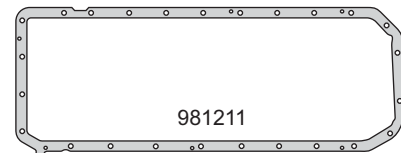
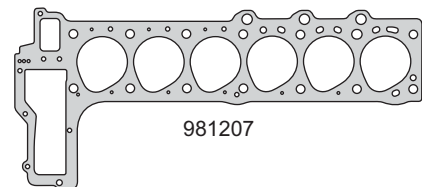

MINI COOPER



Motor/Engine	Cm³	HP	Ø
W10B16A	1598	90/116	77

Mini Cooper: One Coupe (Mini R50) 2000/01
Cooper Coupe (Mini R50) 2000/01



Nº OE	Descripción/Description	Mat.	Ref.
	Jgo. de juntas para motor		981300-R
11.12.7.508.44	Junta tapa cilindros Ø 78 \pm 0.95	NFT	981307
11.12.7.508.543	Junta tapa cilindros Ø 78 \pm 0.65	MLS 1	981308
	Jgo. tornillos tapa cilindros (HAS15038)		B981300
1112.1.485.838	Jgo. junta tapa válvulas (5)	GS 1	981310
	Junta para cárter	GS 1	981311
	Tapa distribución	SLS 1	981312
11.62.1.174.968	Múltiple escape	SLS 1	981315
	Múltiple admisión	SLS 1	981317
11.61.7.513.044	Jgo. múltiple admisión (4)	GS 1	981317-1
18.11.1.170.941	Salida de escape	NFT 1	981318
	Anillo tapa válvulas	GS 4	981333
13.64.1.437.474	O´ring pico inyector superior e inf. G 7.52 x 3.51	GS 8	
	O´ring G 28 x 3.4	GS 2	
	O´ring G 31 x 2.6	GS 1	
	O´ring G 19.5 x 2.3	GS 1	
	O´ring G 15 x 2	GS 1	
	Kit de retenes completo		R981300
13.34.0.029.571	Jgo. retén válvulas (16)	V 1	R981310V
	Retén bancada 91 x 111 x 10	V 1	R981311V
	Retén distribución 32 x 45 x 6	V 1	R981312V

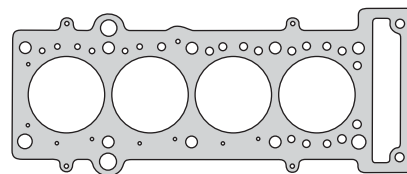

981308

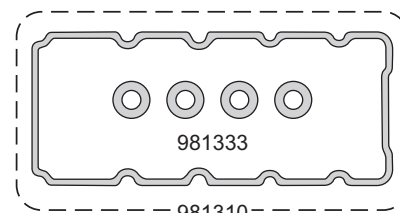

981333

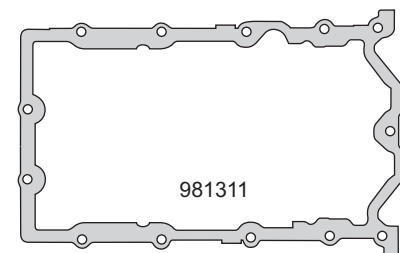

981311

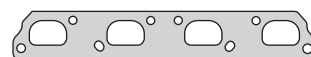

981315



981317



981317-1

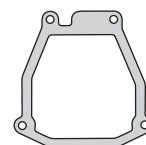

981312



981318



G 15 x 2



G 7.52 x 3.51



G 31 x 2.6



G 19.5 x 2.3



G 28 x 3.4



R981311V



R981312V

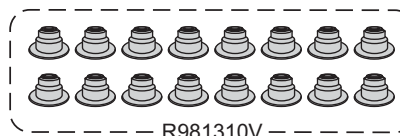

R981310V

BMW



Motor/Engine	Cm³	HP	Ø
M10 B15	1499	70	82
M10 B16	1573	73/84	84
M10 B16	1573	90/103	84

BMW: 1500 1962/86
316 (E21) 1975/84
1500 - 1502 - 1600 (E6)
1602 - 1600 Ti (E10) - 1600 GT



Nº OE	Descripción/Description	Mat.	Ref.
	Jgo. de juntas para motor		981400-R
	Jgo. de juntas superior		981495
	Junta tapa cilindros Ø 86 ±1.70	NFT 1 1	981407
	Junta tapa de válvulas	NFT 1 1	981410
	Junta para cárter	NH 1 1	981411
	Tapa distribución	NB 1 1	981412
	Tapa distribución	NB 1 1	981412-1
	Base distribución	NB 1 1	981413
	Bomba de agua	NB 1 1	981414
	Jgo. múltiple escape (4)	FCH 1 1	981415
	Jgo. múltiple admisión (2)	NB 1 1	981417
	Salida de escape	FCH 1 1	981418
	Bomba de agua	NB 1 1	981419
	Junta carburador	NB 1 1	981423
	Junta	NB 1 1	981427
	Junta bomba de nafta	NB 2 2	981428
	Junta	NB 1 1	981429
	Junta	NB 2 2	981431
	Junta cierre bancada	NB 1 1	981432
	Junta cierre bancada	NB 1 1	981433
	Junta tapón bomba aceite	NB 1 1	981437
	Junta	NB 1 1	981440
	Junta	NB 1 1	981441
	Guarnición goma G 22 x 28 x 4.2	GS 1 1	
	O´ring G 18 x 5	GS 2 2	
	O´ring G 12 x 3	GS 2 2	
	O´ring G 10 x 3.53	GS 1 1	
	Arandela blindada B 22.3 x 26.75 x 2 CN	CN 1 1	
	Arandela blindada B 8.3 x 12 x 1.5 CN	CN 1 1	
	Arandela A 36 x 42 x 2 A	AL 1 1	
	Arandela A 30 x 36 x 2 A	AL 2 2	
	Arandela A 22.5 x 27 x 1.5 A	AL 2 3	
	Arandela A 14.2 x 17.9 x 1.5 A	AL 3 5	
	Arandela A 8 x 11.5 x 1.25 A	AL 2 2	
	Arandela A 22.5 x 27 x 1.5 C	CU 4 4	
	Arandela A 12 x 15 x 1.5 C	CU 5 5	
	Arandela A 6.5 x 10 x 1 C	CU 4 4	
	Arandela A 10.5 x 16 x 1 C	CU 1 1	
	Arandela A 12 x 18 x 1.5 A	AL 1 1	
	Arandela A 12.5 x 15 x 1.5 A	AL 2 2	
	Arandela A 10 x 13 x 1 A	AL 1 1	
	Arandela A 5 x 7 x 1 A	AL 1 1	
	Kit de retenes completo		R981400
	Jgo. retén válvulas (8)	V 1 1	R981410V
	Retén bancada 90 x 110 x 12	V 1 1	R981411V
	Retén distribución 35 x 55 x 12	P 1 1	R981412P

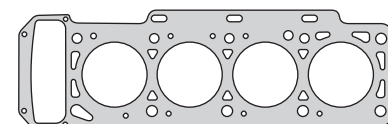

981407

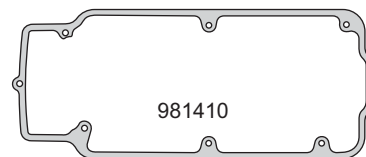

981410

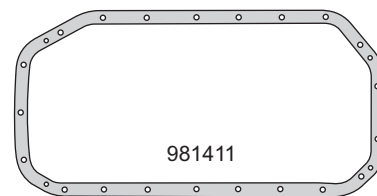

981411

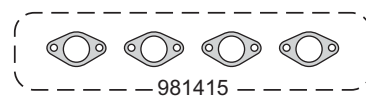

981415

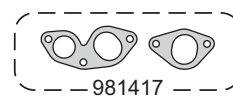

981417

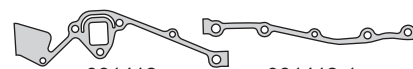

981412

981412-1

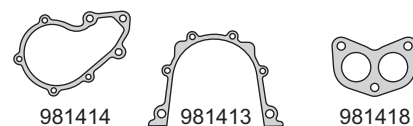

981414

981413

981418

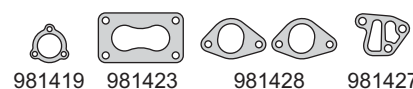

981419

981423

981428

981427

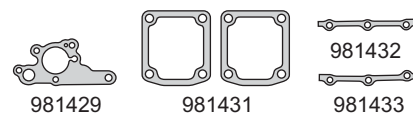

981429

981431

981433

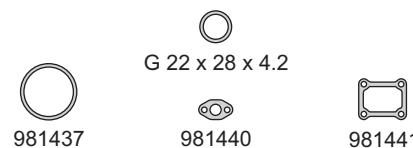

981437

981440

981441

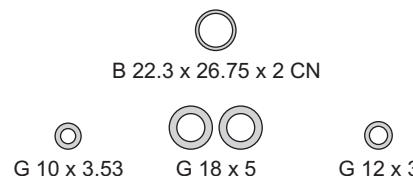

B 22.3 x 26.75 x 2 CN

G 10 x 3.53

G 18 x 5

G 12 x 3



B 8.3 x 12 x 1.5 CN

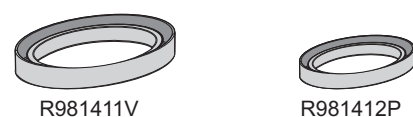

R981411V

R981412P

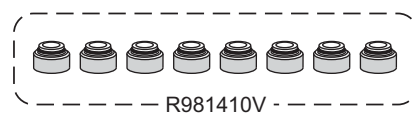

R981410V

BMW



Motor/Engine

Cm³

HP

Ø

N52B25A
(DOHC) 24V

2497

177/218

82

BMW: 523i 2005/... - 323i - 325i - 325xi - X3i
Z4i 2006/...



Nº OE	Descripción/Description	Mat.	Ref.
	Jgo. de juntas para motor		981500-R MLS
	Junta tapa cilindros Ø 85.5 ± 1.30	MLS	1 981508
	Jgo. de tornillos para tapa de cilindros		B981500
	Conj. junta tapa válvulas (2)	GS	1 981510
	Junta para cárter	AC/GS	1 981511
	Jgo. múltiple escape (6)	GFT	1 981515
	Jgo. múltiple admisión G 49 x 2 x 5 (6)	GS	1 981517
	Salida de escape	NFT	2 981518
	Junta termostato	SLS	1 981519
	Junta base filtro aceite	GS	1 981527
	Junta	AC/GS	1 981528
	Junta válvula EGR	GFT	1 981531
	Junta válvula mariposa G 82 x 3 x 11	NFT	1 981532
	Junta tapón árbol de levas	AC/GS	1 981539
	Anillo	AC/GS	1 981540
	Junta llenado aceite	GS	1 981541
	Tapón varilla aceite	GS	1 981542
	Arandela A 22 x 27 x 1.60 C	CU	2
	Arandela A 12.4 x 18 x 1.30 A	AL	1
	O´ring G 7.5 x 3.5	GS	12
	O´ring G 8 x 2	GS	1
	O´ring G 9.2 x 2.5	GS	1
	O´ring G 18 x 2	GS	1
	O´ring G 18 x 3	GS	4
	O´ring G 24 x 2.9	GS	2
	O´ring G 25 x 4	GS	2
	O´ring G 28 x 3	GS	1
	O´ring G 29 x 3.7	GS	1
	Kit de retenes completo		R981500
	Jgo. retén válvulas (24)	V	1 R981510V
	Retén bancada 89 x 110 x 12	T	1 R981511T
	Retén distribución 65 x 79 x 20	T	1 R981513T

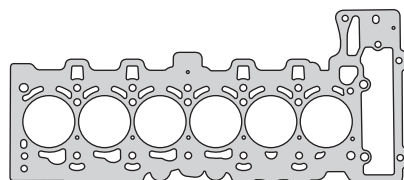

981508

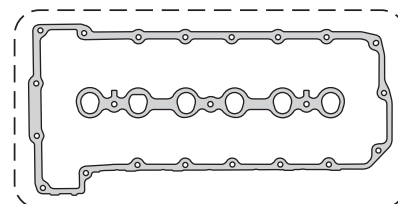

981510

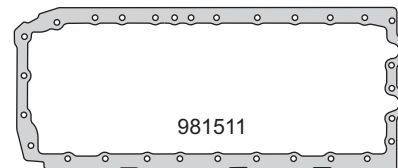

981511

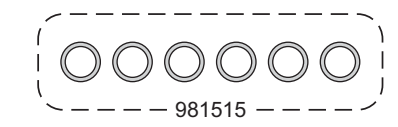

981515



981517

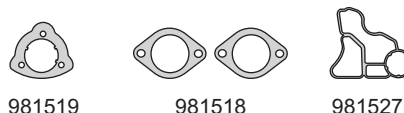

981519

981518

981527



981528

981531

981532



981539

981540

981541

981542

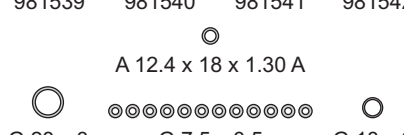

G 28 x 3

G 7.5 x 3.5

G 18 x 2



G 24 x 2.9

G 18 x 3

G 25 x 4

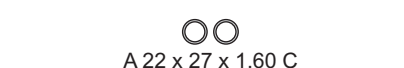

A 22 x 27 x 1.60 C



G 8 x 2

G 29 x 3.7

G 9.2 x 2.5



R981511T



R981513T

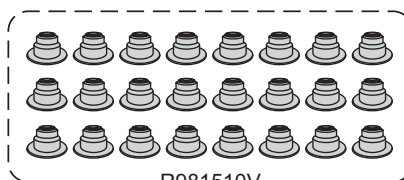

R981510V

BMW



Motor/Engine	Cm³	HP	Ø
N42B18A	1796	115/116	84
N40B16A	1796	115/116	84
N42B20A	1995	143/150	84
N46B20A/B/C (VALVETRONIC) (DOHC) 16V	1995	143/150	84

BMW: 316i - 316 ci Coupe - 316 ti 2000/...
318 ti - 318 ci Cabrio, Coupe 2000/...
320 is 2001/... - 318 ci Cabrio, Coupe
318ti - X3i 2003/... - Z4i 2004/...



Nº OE	Descripción/Description	Mat.	Ref.
	Jgo. de juntas para motor		● 982000-R MLS
	Junta tapa cilindros Ø 84.5 ± 0.45	MLS	1 982008
	Junta tapa de válvulas	GS	1 982010
	Junta para cárter	AL/GS	1 982011
	Junta distribución	GS	1 982012
	Múltiple escape	AC	1 982015
	Jgo. múltiple admisión (4)	GS	1 982017
	Salida de escape	GFT	1 982018
	Junta termostato	GS	1 982019
	Junta bomba de nafta	AL	1 982027
	Junta bomba de nafta	PLAST	1 982028
	Guarnición goma	GS	1 982029
	Guarnición goma	GS	1 982030
	Guarnición base filtro	GS	1 982031
	Guarnición válvula mariposa	GS	1 982032
	Guarnición válvula IAC	GS	1 982033
	Guarnición goma	GS	1 982034
	Guarnición goma	GS	1 982035
	Guarnición base inyector	GS	4 982042
	Guarnición goma	GS	2 982043
	Guarnición entrada de aire	GS	1 982045
	Anillo G 17.5 x 25 x 4.6	GS	3
	O´ring G 30 x 3.53	GS	2
	O´ring G 22 x 3.10	GS	1
	O´ring G 15.9 x 3.20	GS	1
	O´ring G 18 x 3.05	GS	3
	O´ring G 8.8 x 3.05	GS	1
	O´ring G 24.5 x 2.45	GS	4
	O´ring G 7.5 x 3.45	GS	8
	O´ring G 20.5 x 2.50	GS	1
	O´ring G 21.5 x 2.20	GS	2
	O´ring G 24 x 2.90	GS	1
	O´ring G 29.5 x 3.30	GS	4
	O´ring G 31.8 x 4.20	GS	2
	O´ring G 55 x 2.40	GS	1
	Arandela A 13.8 x 18 x 1 A	AL	1
	Arandela A 12.4 x 15.6 x 1 A	AL	1
	Arandela A 22.2 x 27 x 1.5 C	CU	2
	Kit de retenes completo		R982000
	Jgo. retén válvulas (16)	V	1 R982010V
	Retén bancada 90 x 110 x 12	V	1 R982011V
	Retén distribución 65 x 79 x 20	V	1 R982012V

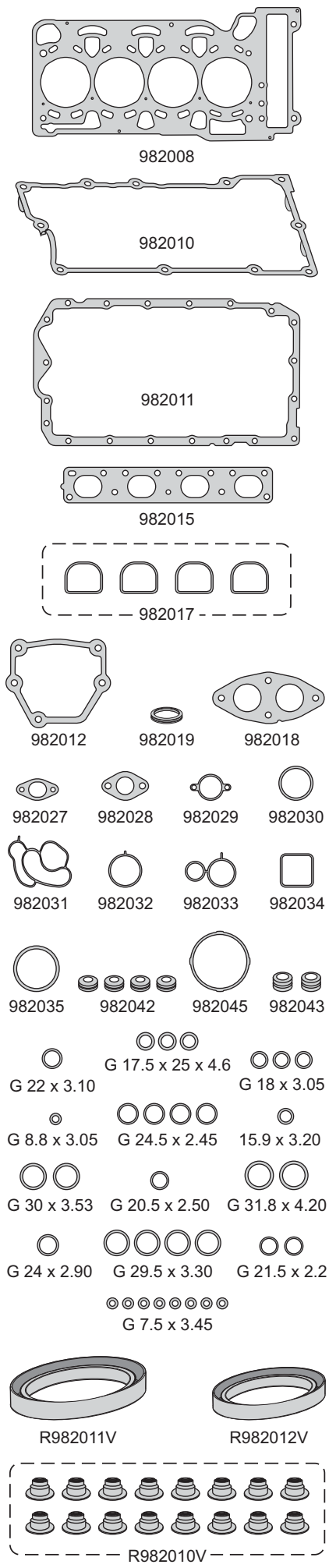



taranto



Junta Tapa de Cilindros Taranto.

Las juntas están diseñadas para superar las exigencias de presión y temperatura que producen los motores de última generación.

- Eliminación del retorque en juntas 07 y 08.
- Mayor resistencia mecánica y térmica.
- Compuestos sellantes especiales que aseguran la máxima estanqueidad.
- Superficie sellante antiadherente que no daña las partes metálicas del motor.
- Ahorro de mano de obra, evita trabajos adicionales.
- Utilización de materiales ecológicos.





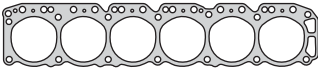
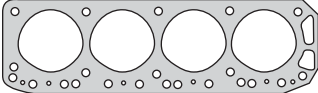
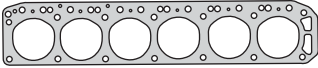
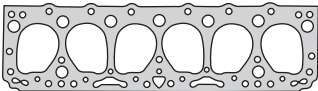
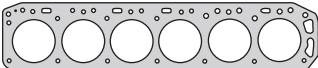
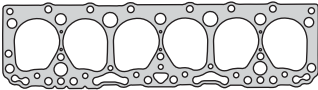
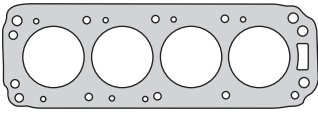
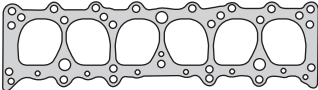
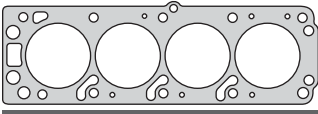
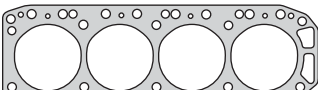





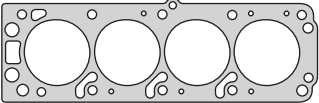

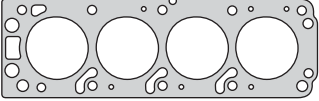

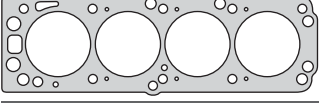



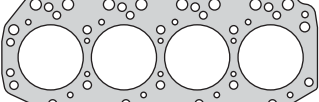

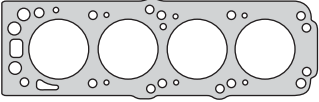



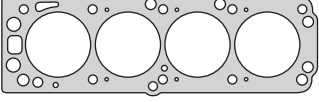

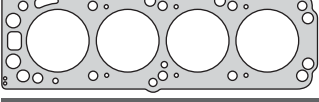

MOTORES NAFTA - DIESEL

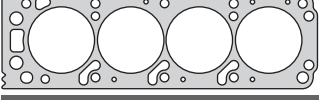

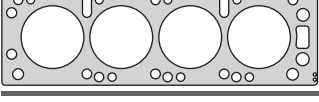
200005 	Código	Ø	⊗	Kit Bulón	Modelo
	200005	102.6	1.40	B200000	400 1964/72 - Super 1964/69 - RS Malibu - Pick Up Chevy 1969/79
200205 	Código	Ø	⊗	Kit Bulón	Modelo
	200205	96.0	1.40		Opel K180 1974/79
200305 - 200307 	Código	Ø	⊗	Kit Bulón	Modelo
	200305 200307	103.0 103.0	1.40 1.40	B200000	Pick Up C10 1989/...
200405 	Código	Ø	⊗	Kit Bulón	Modelo
	200405	95.0	1.70		Apache C10 3.9/16 - Camión 4400 1957/... - Bel Air - Impala 1953/62
200507 	Código	Ø	⊗	Kit Bulón	Modelo
	200507	102.0	1.40	B200000	Silverado - Pick Up 7B 1980/... - Cheyenne 1979/81
200605 	Código	Ø	⊗	Kit Bulón	Modelo
	200605	98.5	1.70		Camión 3 3/4 6500 1954/62 - C10/C14/C60 BR 1969/...
200805 	Código	Ø	⊗	Kit Bulón	Modelo
	200805	84.0	1.40		Chevette 1973/89
200905 	Código	Ø	⊗	Kit Bulón	Modelo
	200905	94.0	1.40		Chevrolet 3 1/2 - Chevrolet 3 9/16 1939/53
240005 	Código	Ø	⊗	Kit Bulón	Modelo
	240005	86.2	1.40	B240000 (HAT55055) (HAT55100)	Monza 1.8 SLE - SEE - Rekord - Kadett 1983/.. Astra 1991/97 - Vectra 1989/95 - Monza - Kadett 1986/91
240105 	Código	Ø	⊗	Kit Bulón	Modelo
	240105	104.4	1.40		Opala 153 1969/73 - Opala A10 80/84/610 1976/.. Opala - C10 - A10 1974/... - Comodoro - Caravan - A10 1980/84

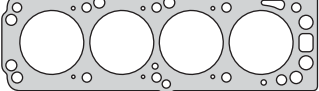

MOTORES NAFTA - DIESEL



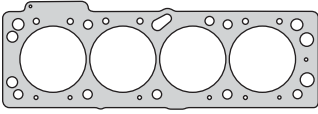
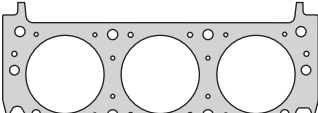
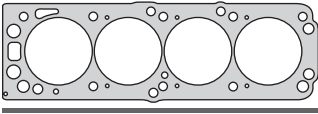
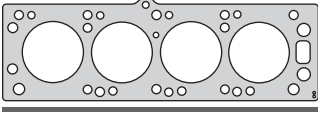
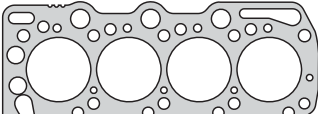

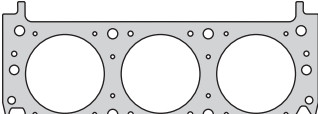
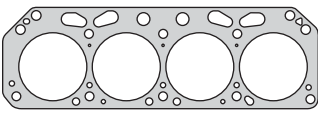
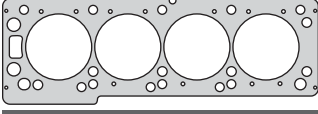
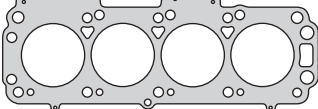





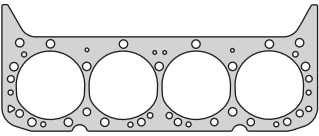



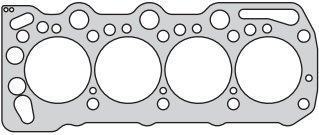





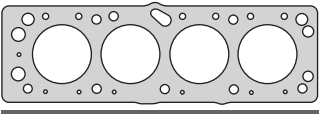

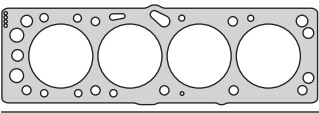

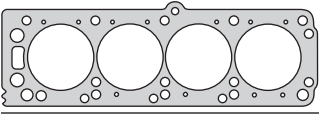
	240205 Código	Ø 88.0	∇ 1.40	Kit Bulón B240000 (HAT55055) (HAT55100)	Modelo Monza 1996/... - Astra 1991/... - Kadett 1986/91 - Ascona 1986/88 Vectra 1988/95 - Blazer
	Motor 1796cc. C18NE FII 90HP Ø84.8 1998cc. C20NE 115/130HP Ø86 (240200-R)  pág. 29				
	240305 Código	Ø 81.5	∇ 1.40	Kit Bulón B240000 (HAT55055) (HAT55100)	Modelo Monza - Kadett 1981/86
	Motor 1598cc. CN16/16SH 90HP Ø80.3 (240300-R)  pág. 30				
	240405 - 240407 Código	Ø 80.5	∇ 1.40	Kit Bulón B240400-1 B240400 (HAE12038)	Modelo Corsa 1.4 EFI - Corsa 1.6 MPFI - Corsa A GSI - Corsa - Vectra Kadett 1999/... - Ascona C 1986/88 - Cavalier 1988/94 - Vectra A 1991/97 Nova 1987/93 - Kadett E 1986/91 - Astra F TD 1994/97
	Motor 1389cc. C14 NV/NZ 60/75HP Ø76.5 (240400-R)  pág. 31 1598cc. C16LZ/NZ/SV-E16ASE-X16SZ 75/82HP Ø79 (240400-R)  pág. 31 1598cc. C16SE/X16SRZ 75/100HP Ø79 (242300-R)  pág. 47				
	240707 - 240708 Código	Ø 94.0	∇ 1.50	Kit Bulón B240700 (HAS17038)	Modelo Pick Up Luv
	Motor 2499cc. 4JA1 76HP Ø93 - DIESEL (240700-R)  pág. 32				
	240905 - 240908 Código	Ø 73.5	∇ 1.40	Kit Bulón B280600 B240400 (HAE12038)	Modelo Celta - Classic - Corsa 2003/... Corsa 1.0 EFI - B10 NZ 1994/... - Corsa B 1993/97 - Prisma - Onix
	Motor 996cc. OHC 60HP Ø71 - 1196cc. OHC 60HP Ø71 (240900-R)  pág. 34 999cc. MPFI (SOHC) 8V 60HP Ø71.1 (241200-R)  pág. 37 999cc. MPFI VHC 60HP Ø71.1 (243300-R MLS)  pág. 52 999cc. SPE/4 80HP Ø71.1 (244200-R MLS)  pág. 57				
	241005 - 241007 Código	Ø 79.0	∇ 1.70	Kit Bulón B240400 B240400-1 B244000 (HAE12038)	Modelo Celta MPFI 2004/... - Corsa A 1990/93 - Kadett E 1986/91 - Nova 1985/... Corsa Econoflex - Classic - Agile - Celta 2006/... - Prisma, Onix
	Motor 1389cc. C14E Familia I 85HP Ø77.6 (241000-R)  pág. 35 1196cc. 12NV/12ST 54/55HP Ø77.8 (241195-R)  pág. 36 1389cc. X14SE/Y14NE - MPFI 90/92HP Ø77.6 (244000-R)  pág. 55 1389cc. SPE/4 106HP Ø77.6 (244300-R MLS)  pág. 58				
	241307 Código	Ø 77.0	∇ 1.30	Kit Bulón B240400 (HAE12038)	Modelo Kadett D - Kadett E 1979/86 - Cavalier - Astra 1980/85
	Motor 1297cc. 13N/SB - 13N/S - 13NS/SC 60/70/75HP Ø75 (241395-R)  pág. 38				
	241507 Código	Ø 88.0	∇ 1.30	Kit Bulón B240000 (HAT55055) (HAT55100)	Modelo Omega MPFI - Vectra MPFI 1992/98 - Frontera 1991/95 - Calibra Cavalier - Kadett 1986/91 - Astra 1991/96 - Omega A 1986/94
	Motor 1998cc. OHC - C20NE/SEH/SER/NEF 110/115/130HP Ø86 (241500-RMX)  pág. 40				
	241607 Código	Ø 84.0	∇ 1.30	Kit Bulón B241700 (HAT55055) (HAT55100)	Modelo Astra 1991/94 - Vectra A 1989/95 - Astra Max 1990/... - Belmont 1989/91
	Motor 1700cc. 17D/DR 57/60HP Ø82.5 - DIESEL (241601-R)  pág. 41				
	241707 Código	Ø 84.0	∇ 1.30	Kit Bulón B241700 (HAT55055) (HAT55100)	Modelo Astra TD - Astra F TD 1994/97
	Motor 1700cc. 17DTL 68HP Ø82.5 - DIESEL (241701-R)  pág. 42				

MOTORES NAFTA - DIESEL



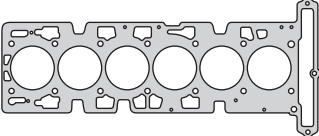

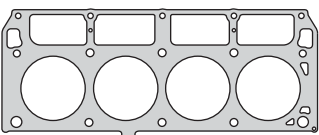





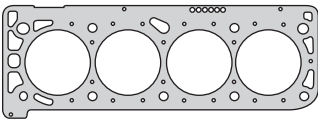

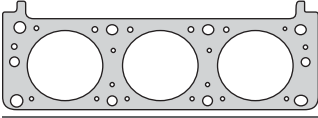

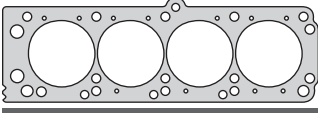

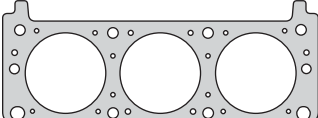

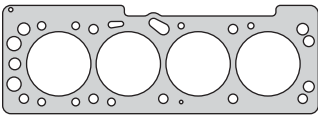

241808 	Código	Ø	≡	Kit Bulón	Modelo
	241808	82.0	0.35	B280600 (HAE12038)	Corsa II - Meriva 2003/...
241905 	Código	Ø	≡	Kit Bulón	Modelo
	241905	91.5	1.70		Cutlass - Century - Eurosport - Cavalier 1989/94
242207 - 242208 	Código	Ø	≡	Kit Bulón	Modelo
	242207 242208	82.0 82.0	1.40 1.40	B242200 (HAE12038)	Corsa - Meriva 2003 - Spin - Cobalt
242407 	Código	Ø	≡	Kit Bulón	Modelo
	242407-SM 242407-1M 242407-2M	82.0 82.0 82.0	1.30 1.40 1.50	B241700 (HAT55055) (HAT55100)	Kadett D - Kadett E 1984/89 - Ascona C - Belmont - Cavalier 1982/86 Ascona C - Kadett E 1986/89
242507 - 242508 	Código	Ø	≡	Kit Bulón	Modelo
	242507-SM 242507-1M 242507-2M 242508-SM 242508-1M 242508-2M	80.0 80.0 80.0 80.0 80.0 80.0	1.40 1.50 1.60 1.40 1.50 1.60	B280200 (HAH10055) (HAH10140)	Astra G DTI - Corsa C DI - Combo Tour TD 2000/...
242607 	Código	Ø	≡	Kit Bulón	Modelo
	242607-SM 242607-1M 242607-2M	77.0 77.0 77.0	1.40 1.50 1.60	B280200 (HAH10055) (HAH10140)	Corsa A TD 1987/92 - Kadett E TD 1984/91 - Nova 1991/96 Isuzu I- Mark - Gemini 1987/... - I-Mark - Gemini TD 1988/...
242805 	Código	Ø	≡	Kit Bulón	Modelo
	242805	92.5	1.20		Citation - Celebrity - Century 1982/86
242905 	Código	Ø	≡	Kit Bulón	Modelo
	242905	103.0	1.20		Pontiac Vin E 1988/92
243408 	Código	Ø	≡	Kit Bulón	Modelo
	243408	89.0	1.40		Astra 2004/... - S10 2005/... - Vectra 2006/...
243508 	Código	Ø	≡	Kit Bulón	Modelo
	243508-SM 243508-1M 243508-2M	84.0 84.0 84.0	1.30 1.40 1.50	B241700 (HAT55055) (HAT55100)	Astra TD 1994/97 - Astra GTD 1998/00 - Motor 14555260 08/1994

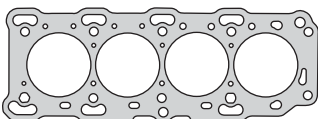

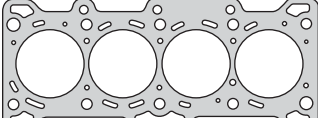
MOTORES NAFTA - DIESEL



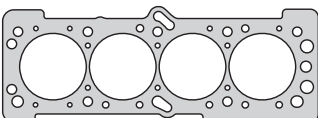







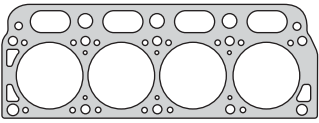

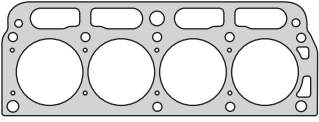



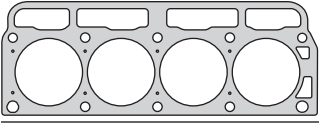

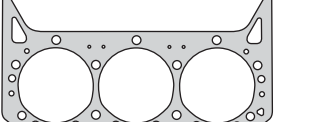



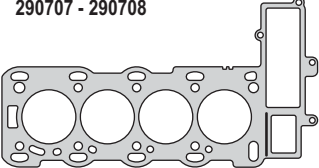



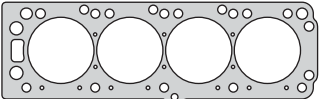



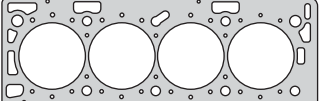

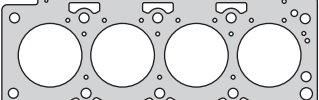

	280105 Código	\varnothing 105.0	∇ 1.20	Kit Bulón	Modelo 283 - 302 - 307 - 327 Carburador - 327 - 350 No Corvette Truck 1996/01 - Pick Up y Medianos - 327 Camiones 1967/... Camiones 350 1986/95 - Vortec Vin R
	Motor 5735cc. GM C350 V8 \varnothing 101.6 (280100-R)  pág. 60 5735cc. GM C350L V8 \varnothing 101.6 (280800)  pág. 67 5735cc. GM C350 V8 \varnothing 101.6 (281100-RMX)  pág. 68				
	280207 - 280208 Código	\varnothing	∇	Kit Bulón	Modelo Corsa D - Combo D 1997/... - Vectra TD 1991/96 - Astra TD 1994/97
	280207-SM 280207-1M 280207-2M 280208-SM 280208-1M 280208-2M	81.0 81.0 81.0 80.5 80.5 80.5	1.40 1.50 1.60 1.40 1.50 1.60	B280200  (HAH10055) (HAH10140)	Motor 1686cc. 4EE1 - 4EE1T 60/82HP \varnothing 79 - DIESEL (280201-R)  pág. 61
	280307 Código	\varnothing 105.0	∇ 1.80	Kit Bulón B280300	Modelo GM D20 - D40 - Pick Up D20
	Motor 3990cc. Maxion S4 102HP \varnothing 100 - DIESEL (280300-R)  pág. 62				
	280407 Código	\varnothing 91.0	∇ 1.70	Kit Bulón B280400  (HAH10055) (HAH10140)	Modelo Luv - Pick Up 1986/92
Motor 2254cc. 4ZD1 88HP \varnothing 89.3 (280400-R)  pág. 63					
	280507 Código	\varnothing 74.0	∇ 1.40	Kit Bulón B280600  (HAE12038)	Modelo Corsa 1998/...
	Motor 999cc. MPFI (DOHC) 16V 68HP \varnothing 71.1 (280500-R)  pág. 64				
	280607 Código	\varnothing 80.5	∇ 1.30	Kit Bulón B280600  (HAE12038)	Modelo Corsa - Opel - Tigra - Astra - Vectra 1993/...
	Motor 1598cc. C16XE - C16XEL (DOHC) 16V 109HP \varnothing 79 (280600-R)  pág. 65				
	280705 - 280707 Código	\varnothing	∇	Kit Bulón	Modelo Astra 1995/... - Omega B - Calibra 1994/... - Vectra 1997/... Calibra - Zafira 1994/... - Sintra 1996/99
	280705 280707	88.0 88.0	1.40 1.40	B280700  (HAT55055) (HAT55100)	Motor 1998cc. X20 XEV (DOHC) 16V 136HP \varnothing 86 (280700-R)  pág. 66 2000/2200cc. MPFI (SOHC) 8V 116/123HP \varnothing 86 (241400-R)  pág. 39 1998/2198cc. X20 XEV - X22 XE 136/141HP \varnothing 86 (290800-R)  pág. 90
	281207 Código	\varnothing 110.0	∇ 1.70	Kit Bulón	Modelo Silverado/GMC Sierra 2500/3500HD - Suburban/GMC Yukon XL Avalanche 2500 - Kodiak 2001/04
Motor 8123cc. L18 V8 550HP \varnothing 108 (281200-R)  pág. 69					
	281308 Código	\varnothing 94.0	∇ 0.70	Kit Bulón	Modelo Trail Blazer 2002/06
	Motor 4160cc. Atlas LL8 - L6 (DOHC) 24V 275HP \varnothing 94 (281300-R)  pág. 70				
	281408 - 281508 Código	\varnothing	∇	Kit Bulón	Modelo Vortec - Silverado - Sierra - Suburban - Tahoe Yukon 2001/03 Express - Pick Up 2500/3500 2001/03
	281408 281508	97.4 102.7	1.30 1.30	Motor 4800cc. LY2 V8 295HP \varnothing 96 - 5300cc. L59 V8 295HP \varnothing 96 (281400-R)  pág. 71 6000cc. LQ4 325HP \varnothing 101.6 (281500-R)  pág. 72	

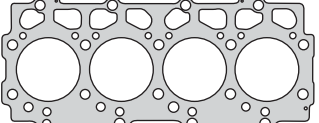
MOTORES NAFTA - DIESEL

	281608	Código	Ø	⊗	Kit Bulón	Modelo	Astra 2000/03
	281608		81.5	0.50	B280600 (HAE12038)	Motor	1796cc. Z18XE 120HP Ø80.5 (281600-R)  pág. 73
	281707	Código	Ø	⊗	Kit Bulón	Modelo	Malibu 2000/03 - Malibu 1997/99
	281707		92.0	1.62		Motor	3100cc. V6 LG8 170HP Ø89 (281700-R)  pág. 74 3136cc. LG8 V6 170HP Ø89 (282200-R)  pág. 79
	281907	Código	Ø	⊗	Kit Bulón	Modelo	Astra 1995/98, Optra, Zafira 1998/...
	281907		88.0	1.30		Motor	1998cc. X20 XEV (DOHC) 16V 128/136HP Ø86 (281900-R)  pág. 76
	282007	Código	Ø	⊗	Kit Bulón	Modelo	Venture - Impala - Monte Carlo - Alero - Gran Am - Aztek - Silhouette Trans Port 2000/03 - Venture 1997/99
	282007		95.0	1.40		Motor	3350cc. LA1 V6 170HP Ø92 (282000-R)  pág. 77 3350cc. LA1 V6 185HP Ø92 (282600-R)  pág. 83
	282108	Código	Ø	⊗	Kit Bulón	Modelo	Cavalier - Malibu - HHR - Astra - Zafira - Vectra - Pontiac Sunfire Grand Am 2000/03
	282108		87.0	0.50		Motor	2168cc. Z22SE - L61 (DOHC) 16V 147HP Ø86 (282100-R)  pág. 78
	282307	Código	Ø	⊗	Kit Bulón	Modelo	Corsa 2002/04
	282307		79.0	1.70		Motor	1389cc. ZX14E 16V 90HP Ø73.4 (282300-R)  pág. 80
	282407	Código	Ø	⊗	Kit Bulón	Modelo	Pontiac Sunfire, Grand Am, Malibu, Cavalier Z24, 1996/04 - Alero 1999/...
	282407		91.0	1.30		Motor	2393cc. LD9 141/152HP Ø90 (282400-R)  pág. 81
	282507	Código	Ø	⊗	Kit Bulón	Modelo	Spark 2003/06 - Aveo 2006/...
	282507		70.0	1.40		Motor	995cc. B10S 63HP Ø68.5 (282500-R)  pág. 82
	290008	Código	Ø	⊗	Kit Bulón	Modelo	Captiva 2008/...
	290008		89.0	0.70		Motor	2384cc. LE5 16V 174HP Ø88 (290000-R MLS)  pág. 84
	290107 - 290108	Código	Ø	⊗	Kit Bulón	Modelo	Nubira 2003/05 - Aveo MPI 2004/...
	290107 290108		80.5 80.0	1.20 0.60	B290100	Motor	1598cc. F16 D3 (DOHC) 16V 103/109HP Ø79 (290100-R)  pág. 85

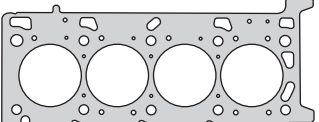

MOTORES NAFTA - DIESEL

	Código 290207	Ø 91.5	 1.60	Kit Bulón 	Modelo Lumina - Cavalier 1987/97
	Motor 2190cc. LN2 120HP Ø89 (290200-R)  pág. 86				
	Código 290307	Ø 91.5	 1.60	Kit Bulón 	Modelo Lumina - Cavalier 1994/97 - Cavalier 1998/03
	Motor 2190cc. LM3 120HP Ø89 (290300-R)  pág. 87 2190cc. LN2 120HP Ø89 (281800-R)  pág. 75				
	Código 290407	Ø 92.0	 1.60	Kit Bulón 	Modelo Cavalier 1994/02
	Motor 2200cc. C134				
	Código 290607	Ø 105.0	 1.20	Kit Bulón 	Modelo Capriche - Impala - Regal - Blazer MPFI 1996/98 - Pick Up 1986/92
	Motor 4294cc. 262 V6 180/193HP Ø101.6 (290600-R)  pág. 88 4300cc. 262 TK V6 Ø101.6 (242700-RMX)  pág. 49 4300cc. 262 V6 Ø101.6 (242100-RMX)  pág. 45				
	Código 290707-SM 290707-1M 290707-2M 290708-SM 290708-1M 290708-2M	Ø 86.0 86.0 86.0 86.0 86.0 86.0	 1.20 1.30 1.40 1.20 1.30 1.40	Kit Bulón B290700  (HAE18038)	Modelo Astra - Vectra - Omega - Opel - Zafira - Frontera - Sintra
	Motor 1995cc. X20 DTL-DTH 82/100HP Ø84 2171cc. X22 DTH 115/116HP Ø84 - DIESEL (290701-R)  pág. 89				
	Código 290907	Ø 88.0	 1.30	Kit Bulón B290900  (HAE14038)	Modelo Vectra 1994/96 - Calibra 1989/97 - Kadett E 1987/91 Calibra Turbo 1992/97 - Vectra Turbo 1993/95
	Motor 1998cc. C20XE 136/150HP - C20LET 204HP Ø86 (290995)  pág. 91				
	Código 291008	Ø 82.0	 0.60	Kit Bulón B280600  (HAE12038)	Modelo Aveo 2009/... - Cruze 2008/... - Astra H 2004/... - Signum - Vectra C 2006/... Zafira B 2005/... - Insignia 2008/...
	Motor 1399cc. F14D4 (DOHC) 16V 101HP Ø73.4 1796cc. F18D4 (DOHC) 16V 141HP Ø80.5 (291000-R MLS)  pág. 92				
	Código 291108-1M 291108-2M 291108-3M	Ø 89.0 89.0 89.0	 1.10 1.20 1.30	Kit Bulón B291100	Modelo Epica - Optra 2006/11 - Lacetti - Nubira - Captiva - Tosca 2007/... Cruze 2009/... - Opel Antara 2006/10
	Motor 1991cc. Z20S/Z20DM 121/150HP (SOHC) 16V Ø83 (291101-R)  pág. 93				
	Código 520307-SM 520307-1M 520307-2M 520308-SM 520308-1M 520308-2M	Ø 95.0 95.0 95.0 95.0 95.0 95.0	 1.40 1.50 1.60 1.42 1.52 1.62	Kit Bulón B520300  (HAS14038)	Modelo Frontera A TD 1995/98
	Motor 2499cc. VM41B 115HP Ø92 - DIESEL (520301-R)  pág. 456				
	Código 582308	Ø 85.0	 0.80	Kit Bulón B580000  (HAE18038)	Modelo Vivaro CDTI 2006/08 - 2008/...
	Motor 1995cc. M9R 780/782/784/786/788 (DOHC) 16V 90/114HP Ø84 - DIESEL (582300-R MLS)  pág. 448				

CHEVROLET



Motor/Engine	Cm³	HP	Ø
194	3185		90.48
230	3769		98.43
250	4047		98.43

Chevrolet: 400 1964/72
Super 1964/69 - RS Malibu
Pick Up Chevy 1969/79

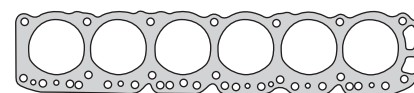

200005

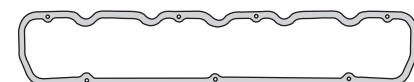

200010

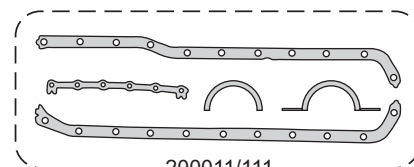

200011/111



200016



200036

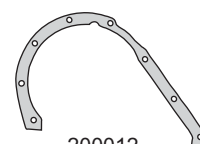

200012

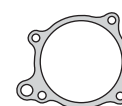

200014



200018

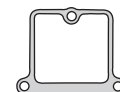

200017



200019



200025



200027



200028



200029



200030



200031



A 13 x 20 x 2 C



200035

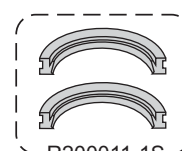

R200011-1S

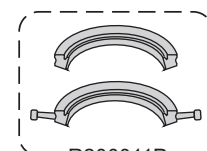

R200011P



R200011-2S



R200012P

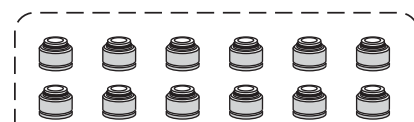

R200010P

Nº OE	Descripción/Description	Mat.	Ref.
	Jgo. de juntas para motor		200000-R
	Jgo. de juntas superior		200095
3788416	Junta tapa cilindros Ø 102.6 ±1.40	NFT 1 1	200005
	Jgo. de tornillos para tapa de cilindros		B200000
3828276	Junta tapa válvulas superior	CG 1 1	200010
3791198	Jgo. junta para cárter hasta 1967 (5)	CG 1 1	200011
5751118	Jgo. junta para cárter 1968/78 (5)	CG 1 1	200111
3788471	Tapa distribución	NB 1 1	200012
3788478	Bomba de agua	NB 1 1	200014
3788487	Múltiple admisión y escape	FCH	200015
3788487	Múltiple escape	NFT 1 1	200016
3788485	Múltiple admisión	NFT 1 1	200017
3696990	Salida de escape	FCH 1 1	200018
3701777	Termostato	CB 1 1	200019
	Jgo. juntas carburador ZENITH - GALILEO	VS	200020
5749650	Jgo. juntas carburador HOLLEY R2751A	VS	200021
	Jgo. juntas carburador HOLLEY RX7214A	VS	200022
2017354	Jgo. juntas carburador ROCHESTER	VS	200023
3828267	Base carburador	NB 1 1	200025
3789970	Tapa bomba aceite	NB	1 200027
5752121	Base bomba nafta	CB	1 200028
	Acople bomba aceite	CB	1 200029
	Base bomba aceite	NB	1 200030
	Succión bomba aceite	NB	1 200031
2017354	Tapa diferencial DANA 44	CG	540034
3789161	Cubierta termostato	NB 1 1	200035
3788497	Tapa válvulas lateral	CG	2 200036
	Jgo. juntas caja velocidades importada	VS	200050
	Jgo. juntas caja velocidades FAE 1ra. Serie	VS	200051
	Jgo. juntas caja velocidades SAGINAW	VS	200151
	Jgo. juntas empaquetadura bancada	SLA	200058
	Diferencial autoblocante	CG	200059
3832420	Jgo. juntas para cárter 1968/78	CGT	200160
5751118	Tapa válvulas superior	CG	200061
3828276	Diferencial autoblocante	CGT	200067
3832420	Tapa diferencial DANA 44	CGT	540068
	Tapa diferencial DANA 44	NH	300086
	Jta. tapa cilindros competición (0.6)	NFT	200090-0.6
	Jta. tapa cilindros competición (0.8)	NFT	200090-0.8
	Jta. tapa cilindros competición (1.0)	NFT	200090-1.0
	Jta. tapa cilindros competición lámina	AC	200090L
	Jta. tapa cil. compet. (0.6) (boca redonda)	NFT	200091-0.6
	Jta. tapa cil. compet. (0.8) (boca redonda)	NFT	200091-0.8
	Jta. tapa cil. compet. (1.0) (boca redonda)	NFT	200091-1.0
	Jta. tapa cil. comp. lámina (boca redonda)	NFT	200091L
	Arandela tapón cárter A 13 x 20 x 2 C	CU	
	Kit de retenes completo		R200000
	Jgo. retén válvulas (12)	P 1	R200010P
	Jgo. retén bancada (2 mitades) 230	P	R200011P
	Jgo. retén bancada (2 mitades) 250	S	R200011-1S
	Jgo. retén bancada reforma expansible	S 1	R200011-2S
	Retén distribución 44.47 x 61.19 x 9.57	P 1	R200012P

GM / CHEVROLET

CHEVROLET



Motor/Engine	Cm³	HP	Ø
K180	1790		90.49

Chevrolet: Opel K180 1974/79



GM / CHEVROLET

Nº OE	Descripción/Description	Mat.	Ref.
	Jgo. de juntas para motor		200200-R
2637381	Junta tapa cilindros Ø 96 ± 1.40	NFT 1	200205
3873851	Junta tapa válvulas superior	CG 1	200210
	Jgo. junta para cárter (4)	CG 1	200211
3788471	Tapa distribución	NB 1	200012
3788478	Bomba de agua	NB 1	200014
2637660	Múltiple escape	NFT 1	200216
2637457	Múltiple admisión	NFT 1	200217
2638526	Salida de escape	FCH 1	200218
3701777	Termostato	CB 1	200019
	Jgo. juntas carburador	VS	200220
5753411	Base carburador	NB 1	200225
3789970	Tapa bomba aceite	NB 1	200027
5752121	Base bomba nafta	CB 1	200028
3789161	Cubierta termostato	NB 1	200035
3788549	Tapa válvulas lateral	CG 1	200236
	Jgo. juntas caja velocidades FAE	VS	200250
	Arandela tapón cárter A 13 x 20 x 2C	CU	
	Kit de retenes completo		R200200
	Jgo. retén válvulas (8)	P 1	R220110P
	Retén bancada (2 mitades)	P	R200011P
	Retén bancada (2 mitades)	S	R200011-1S
	Retén bancada extensible	S 1	R200011-2S
	Retén distribución 44.47 x 61.19 x 9.57	P 1	R200012P

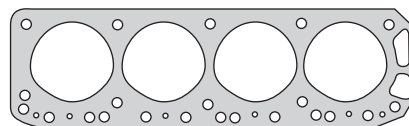

200205

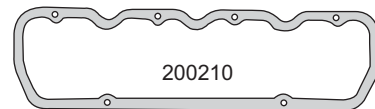

200210

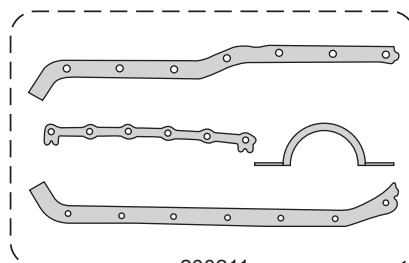

200211

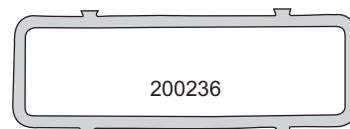

200236



200216

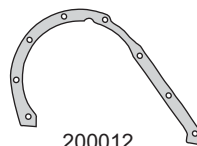

200012

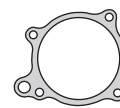

200014



200019



200218



200019



200225



200027



200028



A 13 x 20 x 2 C



200035

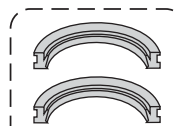

R200011-1S

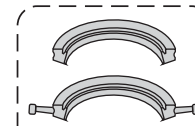

R200011P



R200011-2S



R200012P



R220110P

CHEVROLET



Motor/Engine	Cm³	HP	Ø
250	4097		98.47

Chevrolet: Pick Up C10 1989/...



Nº OE	Descripción/Description	Mat.	Ref.
	Jgo. de juntas para motor		200300-R
	Junta tapa cilindros Ø 103 ± 1.40	NFT	1 200305
	Junta tapa cilindros Ø 103 ± 1.40	NFT	200307
	Jgo. de tornillos para tapa de cilindros		B200000
3828276	Junta tapa válvulas superior	CG	1 200010
	Jgo. junta para cárter (4)	CG	1 200311
	Tapa distribución	NB	1 200312
3788478	Bomba de agua	NB	1 200014
3788487	Múltiple escape	NFT	1 200016
3788485	Múltiple admisión	NFT	1 200017
3701777	Termostato	CB	1 200019
	Jgo. juntas carburador SOLEX TEIE	VS	200120
	Base carburador	NB	200325
	Base carburador SOLEX EIES	NB	2 300425
	Tapa bomba de aceite	NB	1 200327
5752121	Base bomba nafta	CB	1 200028
	Base distribuidor	NB	1 200329
2017354	Tapa diferencial DANA 44	CG	540034
3789161	Cubierta termostato	NB	1 200035
3788497	Tapa válvulas lateral	CG	2 200036
	Jgo. juntas caja velocidades FAE 1ra. Serie	VS	200051
	Jgo. empaquetadura bancada (2)	SNA	1 200658
3828276	Tapa válvulas superior	CG	200061
2017354	Tapa diferencial DANA 44	CGT	540068
2017354	Tapa diferencial DANA 44	NH	300086
	Arandela tapón cárter A 13 x 20 x 2 C	CU	
	Kit de retenes completo		R200300
	Jgo. retén válvulas (12)	P	1 R200010P
	Jgo. retén válvulas (12)	N	1 R200610N
	Retén bancada (2 mitades)	S	R200011-1S
	Retén bancada reforma expansible	S	1 R200011-2S
	Retén bancada 112.5 x 130 x 11	P	R200311P
	Retén distribución 44.47 x 61.19 x 9.57	P	1 R200012P

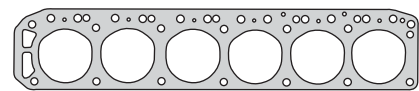

200305

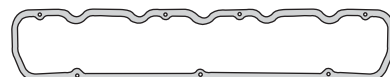

200010

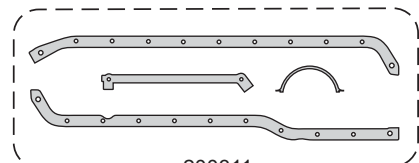

200311



200016



200036

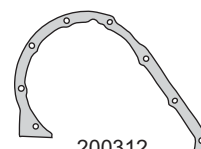

200312

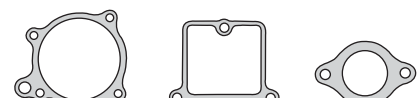

200014

200017

200019

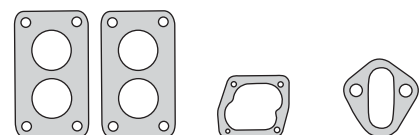

300425

200327

200028

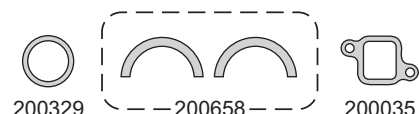

200329

200658

200035

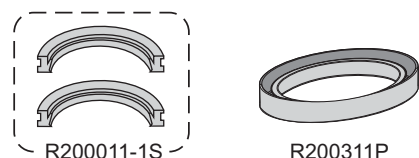

R200011-1S

R200311P



R200011-2S

R200012P

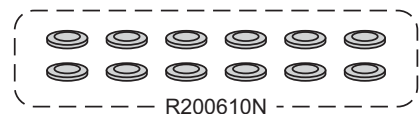

R200610N

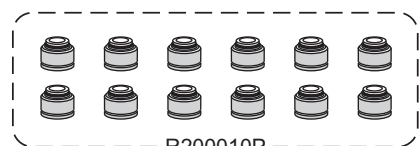

R200010P

GM / CHEVROLET

CHEVROLET



Motor/Engine	Cm³	HP	Ø
235	3851	130	90.48

Chevrolet: Apache C10 3.9/16
Camión 4400 1957/...
Bel Air - Impala 1953/62



N° OE	Descripción/Description	Mat.	Ref.
7364640	Jgo. de juntas para motor		200400-R
3703179	Junta tapa cilindros Ø 95 ± 1.70	NFT 1	200405
3708648	Junta tapa válvulas superior	CG 1	200410
3714551	Jgo. junta para cárter (4)	CG 1	200411
838206	Tapa distribución	CG 1	200912
3835412	Placa distribución	NB 1	200413
3836162	Cuerpo bomba de agua	NB 1	200414
3694871	Jgo. múltiple admisión y escape (3)	NFT 1	200416
838290	Entre múltiples	NFT 1	200917
3696990	Salida de escape	FCH 1	200018
	Jgo. juntas carburador	VS	200420
	Base carburador	NB 1	200425
601348	Base carburador	NB 1	200925
839166	Tapa bomba aceite	NB 1	200927
838263	Base bomba nafta	CB 1	200928
838297	Termostato	CB 1	200929
838341	Salida agua	CB 1	200930
839173	Asiento válvula distribución aceite	NB 1	200931
839174	Tapa distribución aceite	NB 1	200932
838210	Arandelas bujías	CG 6	200933
1523096	Vaso filtro nafta	CG 1	200934
3701542	Tapa válvulas lateral	CG 1	200436
	Jgo. empaquetadura cigüeñal (2)	SNA 1	200658
3714551	Jgo. juntas para cárter	CGT	200460
	Arandela tapón cárter A 13 x 20 x 2 A	AL	
	Kit de retenes completo		R200400
	Jgo. retén válvulas (12)	N 1	R200610N
	Retén distribución 44.47 x 61.19 x 9.57	P 1	R200012P

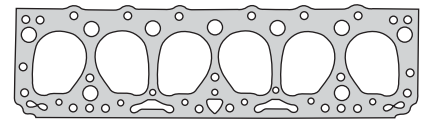

200405

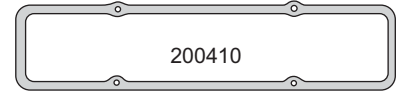

200410

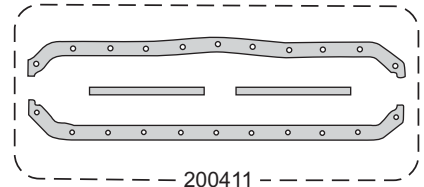

200411

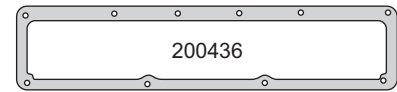

200414

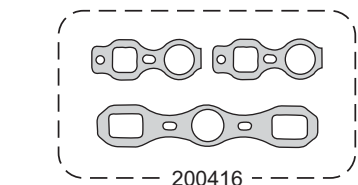

200420

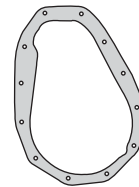

200425

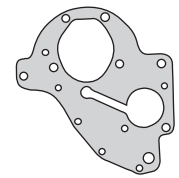

200927

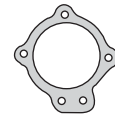

200928



200929

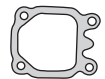

200930



200931



200932

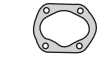

200933



200934

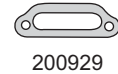

200436

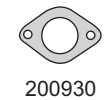

200460



200460



200460



200460



200460

A 13 x 20 x 2 A



200658



R200012P

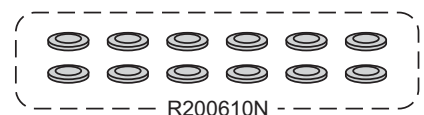

R200610N

GM / CHEVROLET

CHEVROLET



Motor/Engine	Cm³	HP	Ø
250	4097		98.43

Chevrolet: Silverado - Pick Up 7B 1980/...
Cheyenne 1979/81



Nº OE	Descripción/Description	Mat.	Ref.
	Jgo. de juntas para motor		200500
	Junta tapa cilindros Ø 102 ± 1.40	NFT	1 200507
	Jgo. de tornillos para tapa de cilindros		B200000
	Junta tapa válvulas	CG	1 200510
	Jgo. junta para cárter (4)	CG	1 200511
	Tapa distribución	NB	1 200012
	Bomba de agua	NB	1 200014
	Múltiple admisión y escape	NFT	1 200515
	Junta entre múltiples	NFT	1 200017
	Salida de escape	FCH	1 200018
	Junta termostato	CB	1 200019
	Junta base carburador	NB	1 200525
	Junta tapa bomba aceite	NB	1 200027
	Junta tapa bomba nafta	CB	1 200028
	Junta acople bomba aceite	CB	1 200029
	Junta base bomba aceite	NB	1 200030
	Junta succión bomba de aceite	NB	1 200031
	Junta cubierta termostato	NB	1 200035
	Junta lateral válvulas	CG	2 200536
	Arandela tapón cárter A13 x 20 x 2 C	CU	1
	Jgo. retén válvulas (12)	P	R200010P
	Retén bancada 112.5 x 130 x 11	P	R200311P
	Retén distribución 44.47 x 61.19 x 9.57	P	R200012P

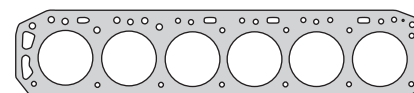

200507

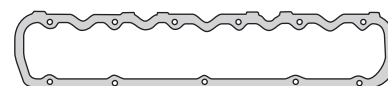

200510

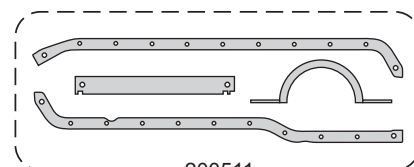

200511

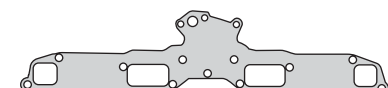

200515



200536

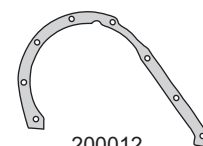

200012

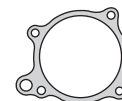

200014



200018

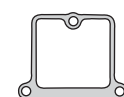

200017



200019

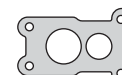

200525



200027



200028



200029



200030



200031



200035

A 13 x 20 x 2 C



R200311P



R200012P

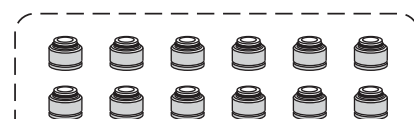

R200010P

GM / CHEVROLET

CHEVROLET



Motor/Engine	Cm³	HP	Ø
261	4277	142	95.25

Chevrolet: Camión 3 3/4 6500 1954/62
C10 - C14 - C60 BR 1969/...

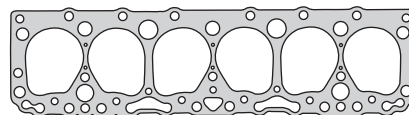

200605



200410

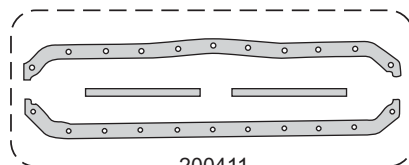

200411

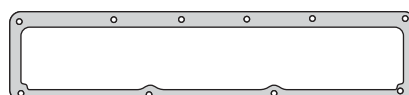

200436

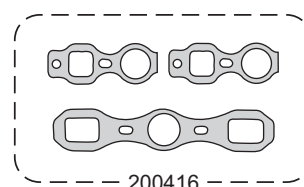

200416

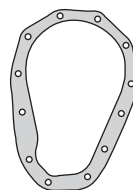

200912



200018

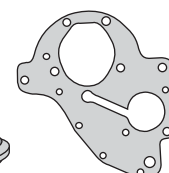

200413

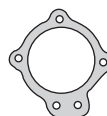

200414



200917



200425



200925



200927



200928

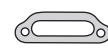

200929



200930



200931



200932



200933



200934

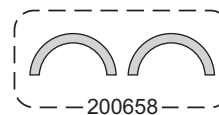

200658



R200012P

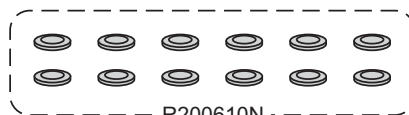

R200610N

Nº OE	Descripción/Description	Mat.	Ref.
	Jgo. de juntas para motor		200600-R
3750625	Junta tapa cilindros Ø 98.5 ± 1.70	NFT 1	200605
3708646	Junta tapa válvulas superior	CG 1	200410
3714551	Jgo. junta para cárter (4)	CG 1	200411
838206	Tapa distribución	CG 1	200912
3835412	Placa distribución	NB 1	200413
3836162	Cuerpo bomba de agua	NB 1	200414
3694871	Jgo. múltiple admisión y escape (3)	NFT 1	200416
838290	Entre múltiples	NFT 1	200917
3696990	Salida de escape	FCH 1	200018
	Base carburador	NB 1	200425
601348	Junta base carburador	NB 1	200925
839166	Tapa bomba aceite	NB 1	200927
838263	Bomba nafta	CB 1	200928
838297	Termostato	CB 1	200929
838341	Salida agua	CB 1	200930
839173	Asiento válvula distribución aceite	NB 1	200931
839174	Tapa distribución aceite	NB 1	200932
838210	Arandelas bujías	CG 6	200933
1523096	Vaso filtro nafta	CG 1	200934
3701542	Tapa válvulas lateral	CG 1	200436
	Jgo. empaquetadura cigüeñal (2)	SNA 1	200658
	Arandela tapón cárter A 13 x 20 x 2 A	AL	
	Kit de retenes completo		R200400
	Jgo. retén válvulas (12)	N 1	R200610N
	Retén distribución 44.47 x 61.19 x 9.57	P 1	R200012P

GM / CHEVROLET

CHEVROLET



Motor/Engine	Cm³	HP	Ø
GMC 85	1393	45	82
GMC 98	1599	71	82

Chevrolet: Chevette 1973/89



Nº OE	Descripción/Description	Mat.	Ref.
7329442	Jgo. de juntas para motor		200800-R
	Jgo. de juntas superior		200895
94601825	Junta tapa de cilindros Ø 84 ± 1.40	NFT 1 1	200805
8966782	Junta tapa válvulas	CG 2 2	200810
8966813	Junta para cárter	CG 1 1	200811
8966792	Tapa distribución frontal motor	CG 1 1	200812
8966851	Bomba de agua	NB 1 1	200814
8966704	Múltiple escape	NFT 1 1	200816
8966825	Múltiple admisión	NB 1 1	200817
9308295	Salida de escape	FCH 1 1	200818
8966853	Base termostato	NB 1 1	200819
	Jgo. juntas carburador	VS	200820
8930191	Junta base carburador	NB 1 1	200725
8930353	Bomba nafta	NB 2 2	550628
8966783	Arandelas tapa válvulas A 8 x 14 x 1.5 NB	NB 4 4	200833
B4A6698A	Buje bomba aceite	GS 1 1	300234
8981886	Árbol de levas	CG 1 1	200835
8966812	Bomba aceite	NB 1 1	200837
8966864	Arandela termostato	NB 1 1	200838
105452	Arandela tapón cárter A 14 x 20 x 1.5 A	AL 1 1	200840
	Kit de retenes completo		R200800
	Jgo. retén válvulas (8)	P 1	R200810P
	Retén bancada 75.9 x 95 x 11.3	P 1	R200811P
	Retén distribución 45 x 60 x 10	P 2	R450412P

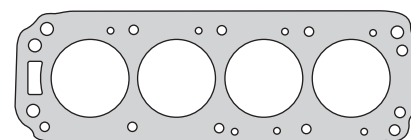

200805

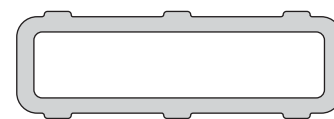

200810

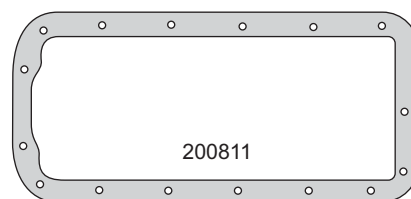

200811



200816

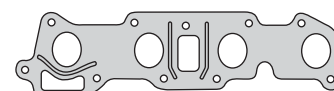

200817

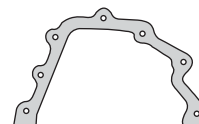

200812



200814



200819

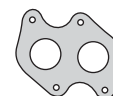

200818



200725



300234



550628



200835



200837



A 14 x 20 x 1.5 A



200838



A 8 x 14 x 1.5 NB



R200811P



R450412P



R200810P

GM / CHEVROLET

CHEVROLET



Motor/Engine	Cm³	HP	Ø
216 - 224 - 235	3540		88.9
216 - 224 - 235	3674		90.5

Chevrolet: Chevrolet 3 ½
Chevrolet 3 9/16 1939/53



Nº OE	Descripción/Description	Mat.	Ref.
	Jgo. de juntas para motor		200900
3835465	Junta tapa cilindros Ø 94 ±1.40	NFT 1	200905
838337	Junta tapa válvulas superior	CG 1	200910
604338	Jgo. junta para cárter (4)	CG 1	200911
838206	Tapa distribución	CG 1	200912
839048	Placa distribución	CB 1	200913
839469	Tapa bomba de agua	CB 1	200914
602483	Jgo. múltiple admisión y escape (3)	NFT 1	200916
838290	Múltiple admisión	NFT 1	200917
3696990	Salida de escape	FCH 1	200018
839470	Placa bomba de agua	CB 1	200919
	Junta base carburador	VS	200920
	Jgo. juntas carburador	NB 1	200425
601348	Base carburador	NB 1	200925
839166	Tapa bomba aceite	NB 1	200927
838263	Bomba nafta	CB 1	200928
838297	Termostato	CB 1	200929
838341	Salida agua	CB 1	200930
839173	Asiento válvula distribución aceite	NB 1	200931
839174	Tapa distribución aceite	NB 1	200932
838210	Arandelas bujías	CG 6	200933
1523096	Vaso filtro nafta	CG 1	200934
602336	Tapa válvulas lateral	CG 1	200936
	Jgo. empaquetadura cigüeñal (2)	SNA	200158
	Arandela tapón cárter A 13 x 20 x 2 A	AL	
	Retén distribución 44.47 x 61.19 x 9.57	P	R200012P

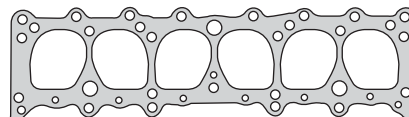

200905

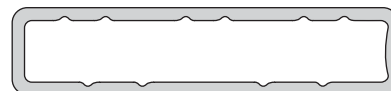

200910

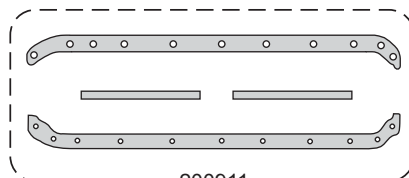

200911

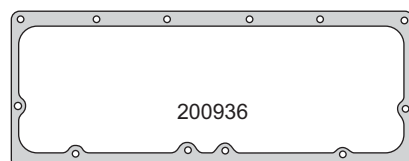

200936

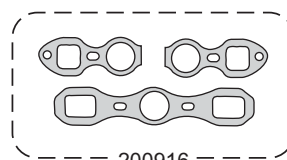

200916

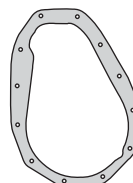

200912



200018

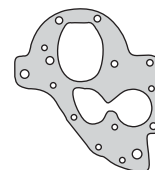

200913

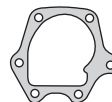

200914



200917



200919



200425



200925



200927



200928



200929



200930



200931



200932



200933



200934



A 13 x 20 x 2 A

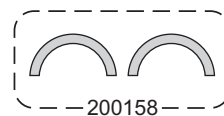

200158



R200012P

CHEVROLET



Motor/Engine	Cm³	HP	Ø
C18N S/E	1796	75/90	84.8

Chevrolet: Monza 1.8 SLE - SEE
Kadett - Rekord 1983/...



Nº OE	Descripción/Description	Mat.	Ref.
	Jgo. de juntas para motor		240000-R
	Jgo. de juntas superior		240095
90122951	Junta tapa cilindros Ø 86.2 ± 1.40	NFT	1 1 240005
	Jgo. de tornillos JTC (HAT55055/HAT55100)		B240000
90106506	Junta tapa válvulas	CG	1 1 240010
90106425	Junta para cárter	CG	1 1 240011
90106432	Bomba aceite y filtro a block	NB	1 1 240012
90106456	O'ring bomba de agua G 90 x 3	GS	1 1 240014
90106615	Múltiple escape	NFT	1 1 240016
90106610	Múltiple admisión	NB	1 1 240017
90128293	Salida de escape	FCH	1 1 240018
90118437	O'ring termostato G 50 x 4	GS	1 1 240019
94624122	Base carburador	NB	2 2 240025
94632563	O'ring bomba aceite succión G 16 x 2.5	GS	1 1 240027
9275602	Separador bomba agua	NB	2 2 550628
90122258	Nivel aceite	NB	1 1 240029
90128513	O'ring succión bomba aceite G 64 x 3	GS	1 1 240030
105462	Arandela frente cárter A 20 x 24 x 1.5 A	AL	1 1 240031
1169011	Arandela bomba aceite A14 x 20 x 1.5 A	AL	2 2 240032
	O'ring termostato G 47 x 4	GS	1 1
	Kit de retenes completo		R240300
	Jgo. retén válvulas (8)	V	1 1 R240010V
	Retén bancada 85.9 x 104 x 11	P	1 1 R240311P
	Retén distribución 31 x 50 x 8	P	1 1 R240012P
	Retén árbol levas 35 x 48 x 7	P	1 1 R240013P

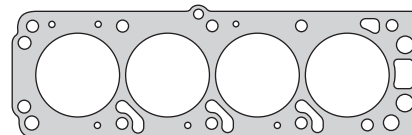

240005

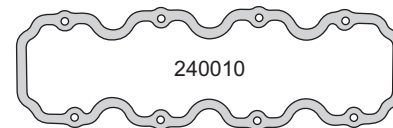

240010

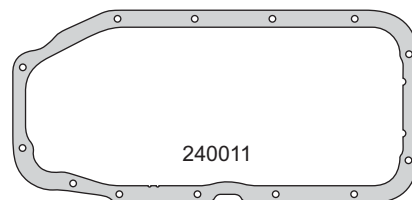

240011

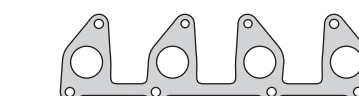

240012



240014



240016

240019

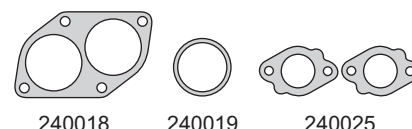

240025

240027

550628

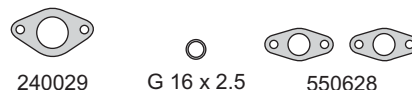

240030

G 16 x 2.5

550628

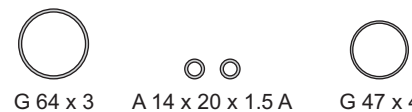

G 64 x 3

A 14 x 20 x 1.5 A

G 47 x 4



A 20 x 24 x 1.5 A

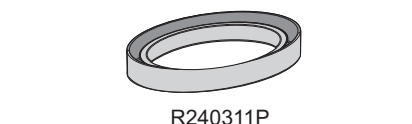

R240311P



R240012P

R240013P



R240010V

CHEVROLET



Motor/Engine	Cm³	HP	Ø
GM 153	2475		101.6

Chevrolet: Opala 153 1969/73
Opala A10 80/84/610 1976/...



GM / CHEVROLET

Nº OE	Descripción/Description	Mat.	1	2	Ref.
7322161	Jgo. de juntas para motor				240100
	Jgo. de juntas superior		●	●	240195
9298684	Junta tapa cilindros Ø 104.4 ± 1.40		NFT	1 1	240105
3873851	Junta tapa válvulas		CG	1 1	200210
7322169	Jgo. junta para cárter (4)		CG	1	240111
3923472	Tapa distribuidor		NB	1	200312
3788478	Tapa bomba de agua		NB	1	200014
7330252	Múltiple admisión y escape		NFT	1 1	240116
3788485	Entre múltiple		NFT	1 1	200017
9299824	Salida de escape		FCH	1 1	200018
3701777	Tapa termostato		CB	1 1	200019
7324660	Base carburador		NB		240125
7324660	Base carburador		NB	1	240825
3789970	Tapa bomba de aceite		NB	1	200327
838263	Base bomba nafta		CB	1	240128
	Base distribuidor		NB		200329
3789161	Cubierta termostato		NB	1 1	200035
3788549	Lateral junta tapa válvulas		CG	1	200236
3921989	Arandela tapón cárter A 13 x 20 x 1 F		F	1	240139
	Junta bomba termostato		NFT	1	240138
	Jgo. empaquetadura cigüeñal (2)		SNA	1	240158
	Jgo. retén válvulas (8)		N	1	R200610N
	Retén bancada 112.5 x 130 x 11		S		R200311P
	Retén distribución 44.47 x 61.19 x 9.57		P		R200012P

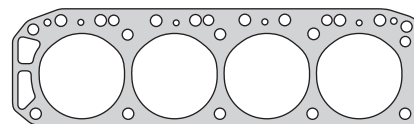

240105

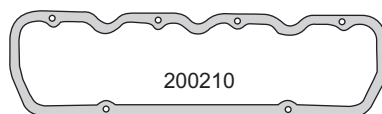

200210

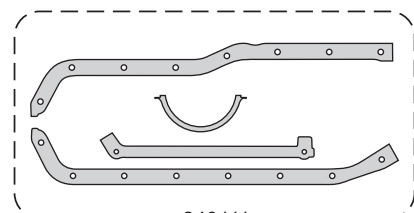

240111

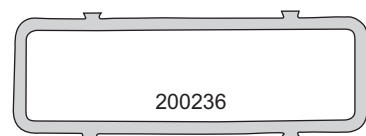

200236

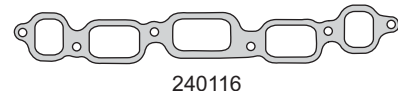

240116

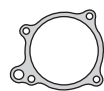
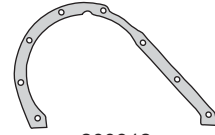

200312

200014

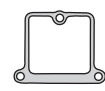

200017

200018

200019



240125

240825

200327



240128

200329

200035

240138

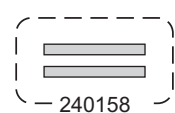

240158



A 13 x 20 x 1 F



R200311P



R200012P

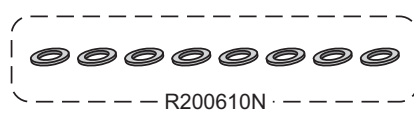

R200610N

CHEVROLET



Motor/Engine	Cm³	HP	Ø
C18NE FII	1796	90	84.8
C20NE	1998	115/130	86

Chevrolet: Monza 1996/... - Astra 1991/...
Kadett 1986/91 - Ascona 1986/88
Vectra 1988/95 - Blazer



Nº OE	Descripción/Description	Mat.	Ref.
	Jgo. de juntas para motor		240200-R
	Jgo. de juntas superior		240295
52272664	Junta tapa cilindros Ø 88 ± 1.40	NFT 1 1	240205
	Jgo. de tornillos JTC (HAT55055/HAT55100)		B240000
90220309	Junta tapa válvulas	CG 1 1	240010
90194295	Junta para cárter	N 1 1	240211
90106432	Block a filtro	NB 1 1	240012
90106456	O'ring tapa bomba de agua G 90 x 3	GS 1 1	240014
90106615	Múltiple escape	NFT 1 1	240016
90215011	Múltiple admisión	NB 1 1	240217
	Múltiple admisión inyección	NFT 1 1	240517
90128293	Salida de escape	FCH 1 1	240018
90118437	O'ring carcasa termostato G 50 x 4	GS 1 1	240019
94624122	Base carburador	NB 2 2	240025
94649659	Base carburador	NB 2 2	240225
94632563	O'ring G 16 x 2.5	GS 1 1	240027
90265732	Base bomba nafta	NB 2 2	550628
90122258	Junta de comando chevrolet	NB 1 1	240029
90128513	O'ring tubo G 64 x 3	GS 1 1	240030
11069511	Arandela bomba aceite A 14 x 20 x 1.5 A	AL 2 2	240032
90231306	Tubo separador bomba aceite	NB 1 1	240232
90183165	Válvula termostato	NB 1 1	240233
11029589	Arandela tapón cárter A 14 x 18 x 1.5 A	AL 1 1	
	Arandela A 20 x 24 x 1.5 A	AL 1 1	
	Kit de retenes completo		R240200
	Jgo. retén válvulas (8)	V 1 1	R240210V
	Retén bancada 90 x 104 x 11	P 1 1	R240211P
	Retén distribución 31 x 50 x 8	P 1 1	R240012P
	Retén árbol levas 35 x 48 x 7	P 1 1	R240013P

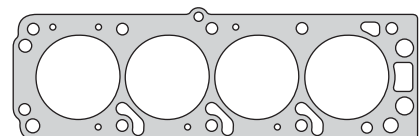

240205

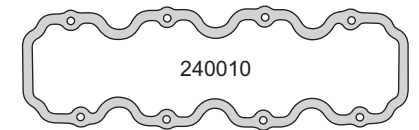

240010

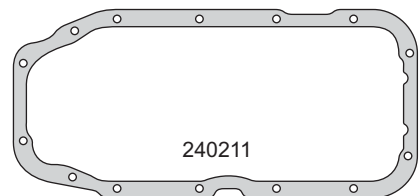

240211

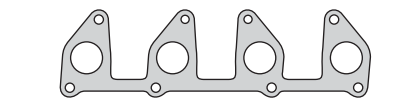

240016



240217

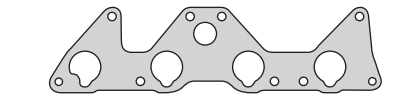

240517



240012



240014

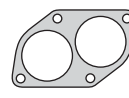

240018



240019

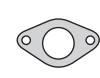

240029



240225

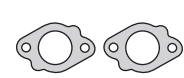

240025

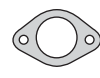

240232

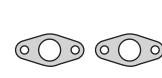

550628

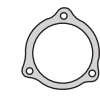

240233



A 20 x 24 x 1.5 A



A 14 x 18 x 1.5 A



G 16 x 2.5

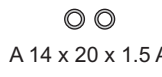

A 14 x 20 x 1.5 A



G 64 x 3



R240012P



R240211P



R240013P



R240210V

CHEVROLET



Motor/Engine	Cm³	HP	Ø
CN16/16SH	1598	90	80.3

Chevrolet: Monza - Kadett 1981/86



Nº OE	Descripción/Description	Mat.	Ref.
	Jgo. de juntas para motor		240300-R
	Jgo. de juntas superior	●	240395
90122958	Junta tapa cilindros Ø 81.5 ± 1.40	NFT 1 1	240305
	Jgo. de tornillos JTC (HAT55055/HAT55100)		B240000
90106506	Junta tapa válvulas	CG 1 1	240010
90106425	Junta para cárter	CG 1 1	240011
90106432	Bomba aceite y filtro a block	NB 1 1	240012
90106456	O'ring bomba de agua G 90 x 3	GS 1 1	240014
90106615	Múltiple escape	NFT 1 1	240016
90106610	Múltiple admisión	NB 1 1	240017
	Múltiple admisión nafta		240317
90128293	Salida de escape	FCH 1 1	240018
90118437	O'ring termostato G 50 x 4	GS 1 1	240019
94624122	Base carburador	NB 2 2	240025
94632563	O'ring succión bomba aceite G 16 x 2.5	GS 1 1	240027
9275602	Bomba nafta	NB 2 2	550628
90122258	Medidor de aceite	NB 1 1	240029
90128513	O'ring succión bomba aceite G 64 x 3	GS 1 1	240030
105462	Arandela desagote cárter A 20 x 24 x 1.5 A	AL 1 1	240031
1169011	Arandela succión b/aceite A14 x 20 x 1.5 A	AL 2 2	240032
	O'ring termostato G 47 x 4	GS 1 1	
	Kit de retenes completo		R240300
	Jgo. retén válvulas (8)	P 1 1	R240010P
	Retén bancada 85.9 x 104 x 11	P 1 1	R240311P
	Retén distribución 31 x 50 x 8	P 1 1	R240012P
	Retén árbol levas 35 x 48 x 7	P 1 1	R240013P

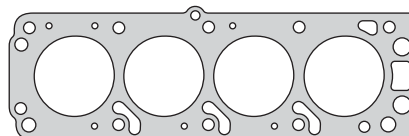

240305

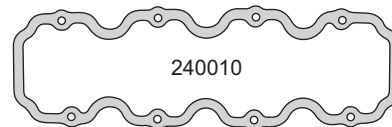

240010

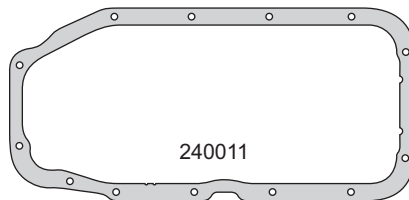

240011

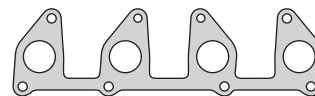

240016



240017



240012

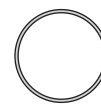

240014



240018



240019



240025



240029



550628



G 16 x 2.5



G 64 x 3



A 14 x 20 x 1.5 A



G 47 x 4



A 20 x 24 x 1.5 A



R240311P



R240012P



R240013P



R240010P

CHEVROLET



Motor/Engine	Cm³	HP	Ø
C14NV/NZ	1389	60/75	76.5
G15MF	1498	75/78	76.5
OHC	1598	75	79
E16SE/X16SZ	1598	75/82	79
C16LZ/NZ/SV	1598	75/82	79

Chevrolet: Corsa 1.4 EFI - 1.6 MPFI - Ascona C 1986/88 - Astra - Vectra A 1991/97
 Corsa A GSI - Nova 1987/93
 Kadett E 1986/91 - Cavalier 1988/94

Daewoo: Lemans - Racer 1989/...
 Cielo - Espero 1994/97



GM / CHEVROLET

Nº OE	Descripción/Description	Mat.	Ref.
	Jgo. de juntas para motor		240400-R
	Jgo. de juntas superior	●	240495
	Junta tapa cilindros Ø 80.5 ± 1.40	NFT 1 1	240405
	Jta. tapa cilindros Ø 80.5 ± 1.40	NFT	240407
	Jgo. tornillos tapa cilindros (HAE12038)		B240400
	Junta tapa válvulas	CG 1 1	240410
	Junta para cárter	CG 1	240411
	Frente motor bomba aceite	NB 1	240412
	O'ring bomba de agua G 79.5 x 3	GS 1	240414
	Múltiple escape	NFT 1 1	240416
	Múltiple admisión 1.4 - C14 NV/NZ	NB 1 1	240417
	Multiple admisión 1.6 - C16 NZ	NB 1 1	240617
	Salida de escape	FCH	240418
	Anillo termostato - Hasta 1998	GS 1 1	240419
	Anillo termostato G 41 x 47 - Desde 1999/...	N 1	240428
	Salida gases 1.4	NB 1	240429
	Salida gases 1.6	NB 1	240629
	Base T.B.I.	NB 1	240433
	Junta tapa botadores	NB 1	240432
	Arandela A 14 x 20 x 1.5 C	CU 2	240434
	O'ring distribución G 40 x 3	GS 1	240436
	O'ring distribuidor G 15.54 x 2.62	GS 1	240435
	O'ring G 40.87 x 3.53	GS 1	
	O'ring G 64 x 3	GS 1	
	Kit de retenes completo		R240400
	Jgo. retén válvulas (8)	V 1	R240210V
	Retén bancada 80 x 98 x 10	V 1	R240411V
	Retén árbol levas 35 x 48 x 7	V 1	R240013V
	Retén distribución 26 x 42 x 8	V 1	R240415V

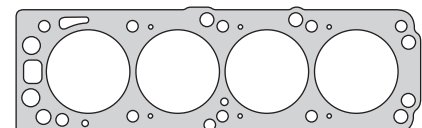

240405

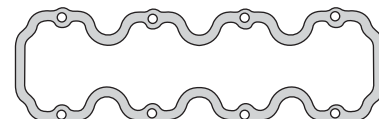

240410

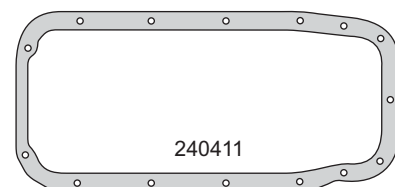

240411

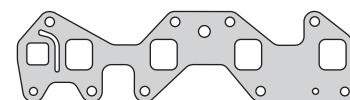

240617

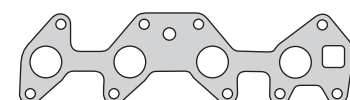

240417

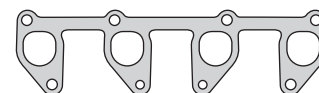

240416

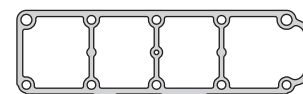

240432

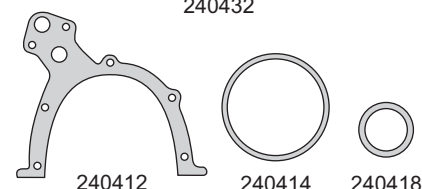

240412

240414

240418



240419

240629

240428

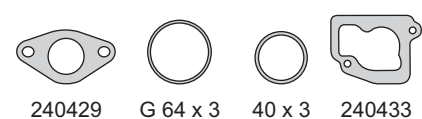

240429

G 64 x 3

40 x 3

240433



A 14 x 20 x 1.5 C

G 15.54 x 2.62

G 40.87 x 3.53

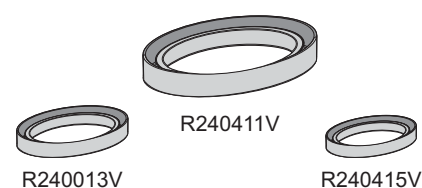

R240013V

R240411V

R240415V



R240210V

CHEVROLET



Motor/Engine	Cm³	HP	Ø
4JA1	2499	76	93
4JB1/4JB1T	2771	87/102	93

Chevrolet: Pick Up Luv
Isuzu: Trooper - Trooper TD 1988/92



DIESEL

Nº OE	Descripción/Description	Mat.	Ref.
	Jgo. de juntas para motor		240700-R
8.94332-326-0	Junta tapa cilindros Ø 94 \pm 1.50	NFT	240707-1M
8.94332-327-0	Junta tapa cilindros Ø 94 \pm 1.60	NFT	240707-2M
8.94332-328-0	Junta tapa cilindros Ø 94 \pm 1.70	NFT	240707-3M
	Junta tapa cilindros Ø 94 \pm 1.50	MLS 1	240708
	Junta tapa cilindros Ø 94 \pm 1.60	MLS	240708-2M
	Junta tapa cilindros Ø 94 \pm 1.70	MLS	240708-3M
897133416-1	Jgo. tornillos tapa cilindros (HAS17038)		B240700
89424-7-403-1	Junta tapa válvulas	GS 1	240710
	Junta para cárter	GS 1	240711
894150-790	Cogotera trasera cárter	GS 1	930511-3
897120-933-0	Cogotera delantera cárter	GS 1	930511-4
PTG84	Tapa distribución	GS 1	930512
	Placa distribución	NH 1	240713
	Bomba de agua	GS 1	240714
	Múltiple escape con reflector	CHA 1	930515
	Múltiple admisión	NH 1	240717
	Tapa termostato	NH 1	240719
	Guarnición base filtro aceite	GS 1	240727
	Base termostato	NH 1	240729
	Acople termostato	NH 1	240730
	Brida	NH 1	240731
97113069-0	Cárter inferior trasero	NH 1	930532
	Guarnición tapa válvulas	CH/GS	240733
	Arandela especial con rebaje A 8 x 12 x 2.5 C	CU 1	240734
	Arandela con inserto	CH/GS 3	240735
	Bujes cónicos	CH/GS 4	240736
	O'ring G 14.5 x 2.62	GS 4	
	O'ring G 78 x 3	GS	
	Arandela A 14 x 24 x 1 C	CU 1	
	Arandela A 8.5 x 14 x 1 C	CU 2	
	Kit de retenes completo		R240700
	Jgo. retén válvulas (8)	V 1	R240710V
	Retén bancada 95 x 118 x 8.5	P 1	R240711P
	Retén distribución 50 x 68 x 10	P 1	R550612P
	Retén árbol de levas 30 x 45 x 8	P	R240713P

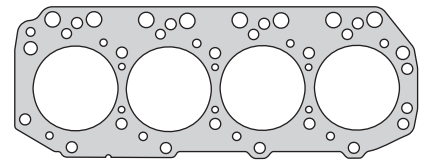

240708

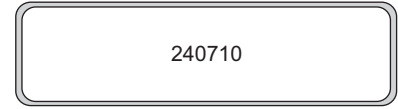

240710

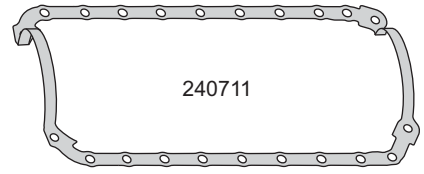

240711



930532

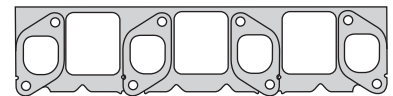

930515



240717



930511-3

930511-4

930512

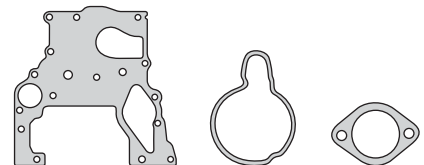

240713

240714

240719

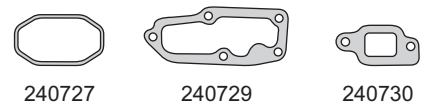

240727

240729

240730

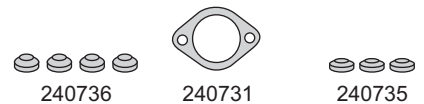

240736

240731

240735

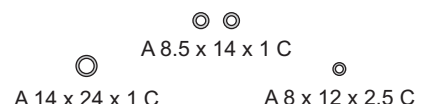

A 8.5 x 14 x 1 C

A 14 x 24 x 1 C

A 8 x 12 x 2.5 C



G 14.5 x 2.62

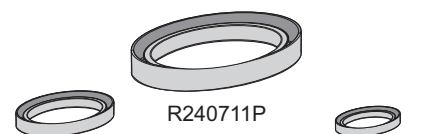

R240711P

R550612P

R240713P



R240710V

CHEVROLET



Motor/Engine	Cm³	HP	Ø
GM151	2475	90	101.6

Chevrolet: Opala - C10 - A10 1974/...
Comodoro - Caravan - A10 1980/84



Nº OE	Descripción/Description	Mat.	Ref.
9300141	Jgo. de juntas para motor		240800
	Jgo. de juntas superior		240895
9298684	Junta tapa cilindros Ø 104.4 ± 1.40	NFT 1 1	240105
3873851	Junta tapa válvulas	CG 1 1	200210
7322169	Jgo. junta para cárter (4)	CG 1	240111
3923472	Tapa distribución	NB 1	200312
3788478	Tapa bomba de agua	NB 1	200014
9298047	Múltiple admisión y escape	NFT 1 1	240816
3788485	Entre múltiple	NFT 1 1	200017
9299824	Salida de escape	FCH 1 1	200018
3701777	Tapa termostato	CB 1 1	200019
7324660	Base carburador	NB 1 1	240825
3789970	Tapa bomba de aceite	NB 1	200327
838263	Base bomba nafta	CB 1	240128
3789161	Cubierta termostato	NB 1 1	200035
3788549	Lateral junta tapa válvulas	CG 1	200236
3921989	Arandela tapón cárter A 13 x 20 x 1 F	F 1	240139
7328511	Jgo. empaquetadura cigüeñal (2)	SNA 1	240158
3835333	Jgo. retén válvulas (8)	N 1	R200610N
3980267	Retén bancada 112.5 x 130 x 11	P	R200311P
	Retén distribución 44.47 x 61.19 x 9.57	P	R200012P

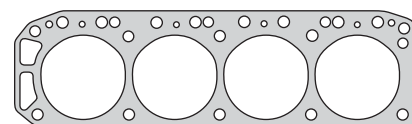

240105

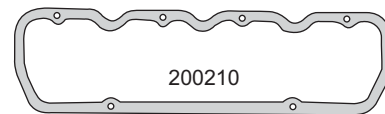

200210

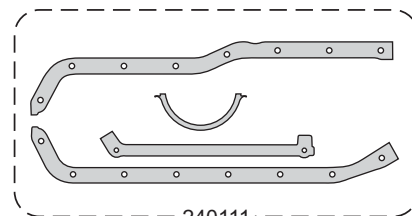

240111

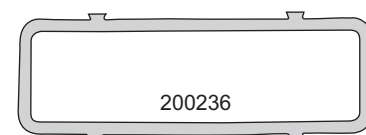

200236



240816

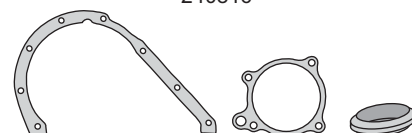

200312

200014

200018



200017

200019

240825

200327

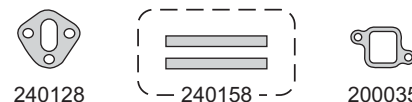

240128

240158

200035

A 13 x 20 x 1 F

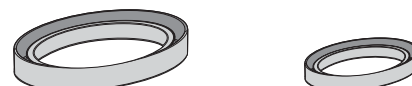

R200311P



R200012P

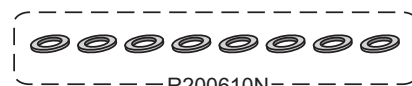

R200610N

GM / CHEVROLET

CHEVROLET



Motor/Engine	Cm³	HP	Ø
OHC	996	60	71
C12NZ/12NZ	1196	45	72
X12SZ	1196	45	72

Chevrolet: Corsa 1.0 EFI - B10 NZ 1994/...
Corsa B 1993/97

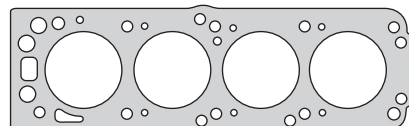

240905

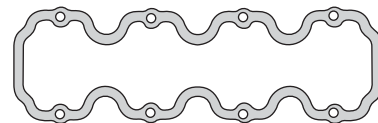

240410

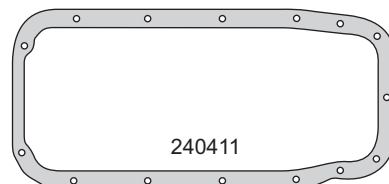

240411

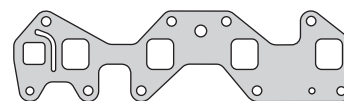

240617

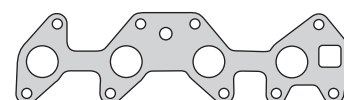

240417

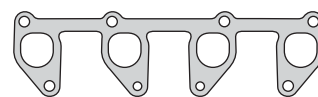

240416

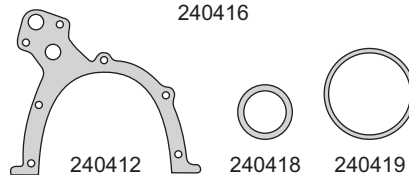

240412

240418

240419

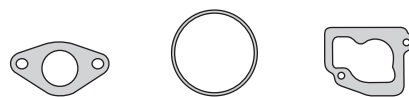

240429

G 79.5 x 3

240433



G 40 x 3



A 14 x 20 x 1.5 A



G 15.54 x 2.62



G 64 x 3



R240411P



R240013P



R240415P



R240210V

Nº OE	Descripción/Description	Mat.	1	1	Ref.
	Jgo. de juntas para motor				240900-R
	Jgo. de juntas superior	●			240995
	Jta. tapa cilindros Ø 73.5 ±1.40	NFT	1	1	240905
607998	Jta. tapa cilindros Ø 74 ±1.40	MLS			240908
	Jgo. tornillos tapa cilindros (HAE12038)				B240400
	Junta tapa válvulas	CG	1	1	240410
	Junta para cárter	CG	1	1	240411
	Frente motor bomba aceite	NB	1	1	240412
	Múltiple escape	NFT	1	1	240416
	Múltiple admisión	NB	1	1	240417
	Múltiple admisión 1.6	NB	1	1	240617
	Salida de escape	FCH			240418
	Anillo termostato	GS	1	1	240419
	Salida gases 1.4	NB		1	240429
	Base T.B.I.	NB		1	240433
	O'ring distribuidor G 15.54 x 2.62	GS		1	
	O'ring bomba agua G 79.5 x 3	GS		1	
	O'ring G 40 x 3	GS		1	
	O'ring distribución G 64 x 3	GS		1	
	Arandela A 14 x 20 x 1.5 A	AL		1	
	Kit de retenes completo				R240400
	Jgo. retén válvulas (8)	V	1	1	R240210V
	Retén bancada 80 x 98 x 10	P	1	1	R240411P
	Retén distrib. bomba aceite 26 x 42 x 8	P	1	1	R240415P
	Retén árbol levas 35 x 48 x 7	P	1	1	R240013P

CHEVROLET



Motor/Engine	Cm³	HP	Ø
C14E Familia I	1389	85	77.6

Chevrolet: Celta MPFI 2004/...



Nº OE	Descripción/Description	Mat.	Ref.
	Jgo. de juntas para motor		241000-R
	Jgo. de juntas superior	●	241095
	Junta tapa cilindros Ø 79 \pm 1.20		241007
	Junta tapa cilindros Ø 79 \pm 1.80	NFT 1 1	241007-1.8
	Jgo. tornillos tapa cilindros (HAE12038)		B240400-1
	Junta tapa válvulas	N 1 1	241010
	Junta para cárter	CG 1 1	240411
	Frente bomba aceite	SLS 1 1	241812
	Múltiple escape	NFT 1 1	240416
	Múltiple admisión	NB 1 1	240617
	Múltiple admisión	NB 1 1	241017
	Salida de escape	FCH 1 1	240018
	Descarga gases 1.4	GS 1 1	240419
	Junta termostato	GS 1 1	241219
	Junta termostato	NB 1 1	240429
	Junta	CB 1 1	241230
	Anillo goma	NB 1 1	241231
	Junta tapa botadores	NB 1 1	240432
	Arandela A 14 x 20 x 1.5 C	CU 2 2	
	Arandela A 20 x 24 x 1.5 A	AL 1 1	
	O´ring G 13.94 x 2.62	GS 1 1	
	O´ring G 21.89 x 2.62	GS 2 2	
	O´ring G 47 x 4	GS 1 1	
	O´ring G 64.77 x 2.62	GS 1 1	
	O´ring G 79.5 x 3	GS 1 1	
	O´ring G 9.19 x 2.62	GS 1 1	
	Kit de retenes completo		R240400
	Jgo. retén válvulas (8)	V 1 1	R240210V
	Retén bancada 80 x 98 x 10	P 1 1	R240411P
	Retén distrib. bomba aceite 26 x 42 x 8	P 1 1	R240415P
	Retén árbol levas 35 x 48 x 7	P 1 1	R240013P

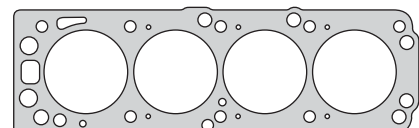

241007-1.80

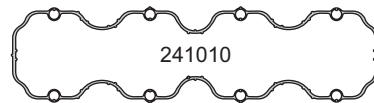

241010

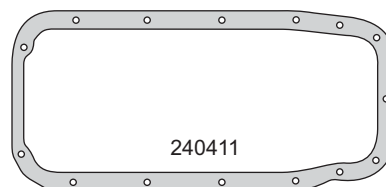

240411

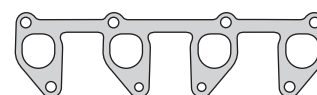

240416

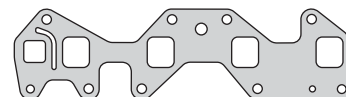

240617

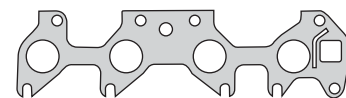

241017

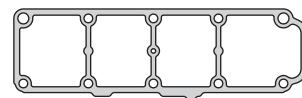

240432

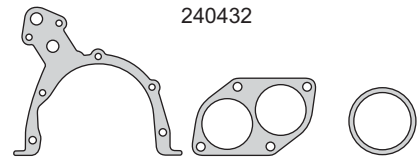

241812

240018

241219

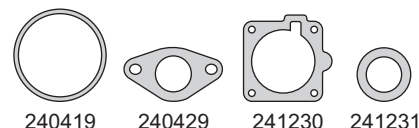

240419

240429

241230

241231



A 14 x 20 x 1.5 C

A 20 x 24 x 1.5 A

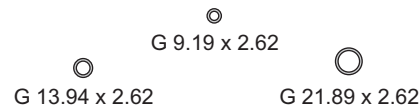

G 9.19 x 2.62

G 13.94 x 2.62

G 21.89 x 2.62



G 79.5 x 3

G 64.77 x 2.62

G 47 x 4



R240013P

R240411P

R240415P

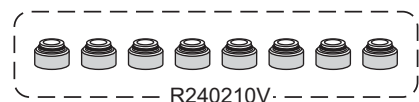

R240210V

GM / CHEVROLET

CHEVROLET



Motor/Engine	Cm³	HP	Ø
12NV	1196	55	77.8
12ST	1196	54/55	77.8

Chevrolet: Corsa A 1990/93 - Kadett E 1986/91
Vauxhall: Nova 1985/...

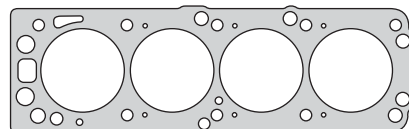

241007

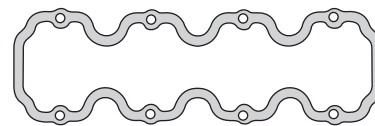

240410

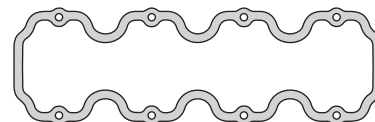

241110

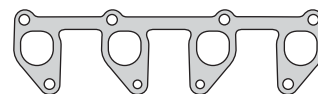

240416

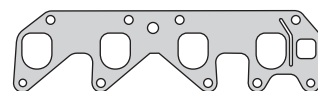

241117

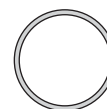

240419



R240013P



R240210V

Nº OE	Descripción/Description	Mat.	Ref.
	Jgo. de juntas superior	●	241195-R
	Junta tapa cilindros Ø 79 \pm 1.70	NFT	241005
	Junta tapa cilindros Ø 79 \pm 1.20	NFT 1	241007
	Junta tapa cilindros Ø 79 \pm 1.80	NFT	241007-1.8
	Jgo. tornillos tapa cilindros (HAE12038)		B240400
	Jgo. tornillos tapa cilindros (HAE12038)		B240400-1
	Junta tapa válvulas	CG 1	240410
	Junta tapa válvulas	CG 1	241110
	Múltiple escape	NFT 1	240416
	Múltiple admisión	NB 1	241117
	Anillo termostato	GS 1	240419
	Jgo. retén válvulas (8)	V 1	R240210V
	Retén arbol levas 35 x 48 x 7	P 1	R240013P

GM / CHEVROLET

CHEVROLET



Motor/Engine	Cm³	HP	Ø
MPFI (SOHC) 8V	999	60	71.1

Chevrolet: Celta 2000/...
Suzuki: Fun 2002/...



Nº OE	Descripción/Description	Mat.	Ref.
	Jgo. de juntas para motor		241200-R
	Jgo. de juntas superior		241295
	Junta tapa cilindros Ø 73.5 ± 1.40	NFT 1 1	240905
607998	Junta tapa cilindros Ø 74 ± 1.40	MLS	240908
	Jgo. tornillos tapa cilindros (HAE12038)		B280600
	Junta tapa válvulas	N 1 1	241010
	Junta para cárter	CG 1	240411
	Frente motor bomba aceite	NB 1	240412
	Múltiple admisión y escape	NFT 1 1	240416
	Múltiple admisión	NB 1 1	241017
	Junta termostato	GS 1	241219
	Salida gases 1.4	NB 1 1	240429
	Junta soporte inyección TBI	CB 1 1	241230
	Anillo goma	NB 1	241231
	O'ring G 79.5 x 3	GS 1	
	O'ring G 9.19 x 2.62	GS 1	
	O'ring G 64 x 3	GS 1	
	Kit de retenes completo		R240400
	Jgo. retén válvulas (8)	V 1	R240210V
	Retén bancada 80 x 98 x 10	P 1	R240411P
	Retén árbol levas 35 x 48 x 7	P 1	R240013P
	Retén distrib. bomba aceite 26 x 42 x 8	P 1	R240415P

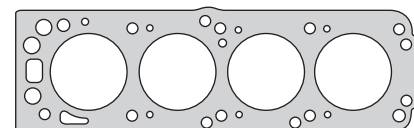

240905



241010

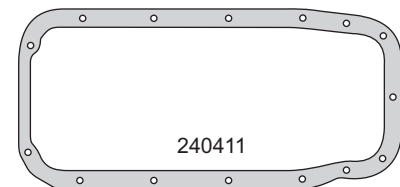

240411

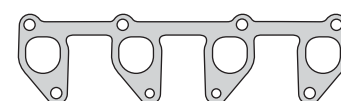

240416

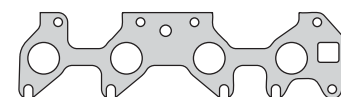

241017

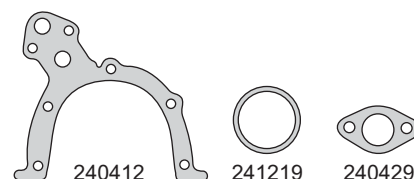

240412

241219

240429



241230

241231

G 79.5 x 3

G 64 x 3

G 9.19 x 2.62



R240013P



R240415P



R240411P



R240210V

CHEVROLET



Motor/Engine	Cm³	HP	Ø
13N/SB	1297	60/70/75	75
13N/S-13NS/SC	1297	60/70/75	75

Chevrolet: Kadett D - Kadett E 1979/86
Vauxhall: Cavalier - Astra 1980/85

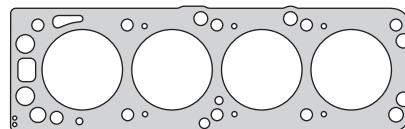

241307

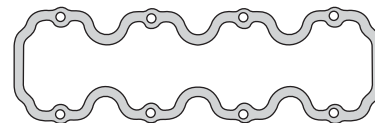

240410

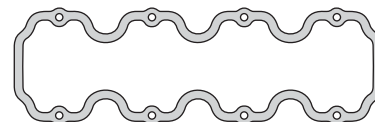

241110

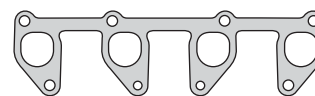

240416

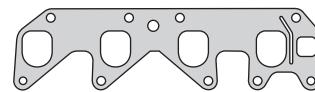

241117



240419



G 64.77 x 2.62



R240013P



R240210V

Nº OE	Descripción/Description	Mat.	Ref.
	Jgo. de juntas superior		241395-R
	Junta tapa cilindros Ø 77 ± 1.30	NFT 1	241307
	Jgo. tornillos tapa cilindros (HAE12038)		B240400
	Junta tapa válvulas	CG 1	240410
	Junta tapa válvulas	CG 1	241110
	Múltiple escape	NFT 1	240416
	Múltiple admisión	NB 1	241117
	Anillo termostato	GS 1	240419
	O´ring G 64.77 x 2.62	GS 1	
	Jgo. retén válvulas (8)	V 1	R240210V
	Retén arbol levas 35 x 48 x 7	P 1	R240013P

GM / CHEVROLET

CHEVROLET



Motor/Engine	Cm³	HP	Ø
MPFI	2000	116	86
MPFI (SOHC) 8V	2200	123	86

Chevrolet: Vectra 1997/...



Nº OE	Descripción/Description	Mat.	Ref.
	Jgo. de juntas para motor		241400-R
	Jgo. de juntas superior		241495
	Junta tapa cilindros Ø 88 ±1.40	NFT 1 1	280705
	Junta tapa cilindros Ø 88 ±1.40		280707
	Jgo. de tornillos JTC (HAT55055/HAT55100)		B280700
90 467 661	Junta tapa de válvulas	N 1 1	241410
6 52 635	Junta para cárter superior	NFT 1 1	290811
90106615	Bomba aceite filtro a block	NB 1 1	240012
	Múltiple admisión y escape	NFT 1 1	240016
	Múltiple admisión EFI	NFT 1 1	240517
90128293	Múltiple admisión MPFI	NB 1 1	241417
94649659	Salida de escape	FCH 1 1	240018
90122258	Junta base carburador	NB 2 2	240225
	Junta mando	NB 1 1	240029
	Junta soporte inyección TBI	CB 1 1	241230
	Junta	NB 1 1	241430
90231306	Junta	NB 1 1	241431
90183165	Tubo separador bomba aceite	NB 1 1	240232
	Válvula termostato	NB 1 1	240233
6 52 636	Junta sobre cárter	CG 1 1	290832
	Arandela A 14 x 18 x 1.5 A	AL 1 1	
	O´ring G 15.54 x 2.62	GS 1 1	
	O´ring G 16 x 2	GS 1 1	
	O´ring G 47.22 x 3.53	GS 2 2	
	O´ring G 50 x 4	GS 1 1	
	O´ring G 52.07 x 2.62	GS 1 1	
	O´ring G 53.7 x 1.78	GS 1 1	
	O´ring G 64.77 x 2.62	GS 3 3	
	O´ring G 88.57 x 2.62	GS 1 1	
	Kit de retenes completo		R240200
	Jgo. retén válvulas (8)	V 1 1	R240210V
614 827	Retén bancada 90 x 104 x 11	P 1 1	R240211P
646 265	Retén distribución 31 x 50 x 8	P 1 1	R240012P
636 841	Retén árbol de levas 35 x 48 x 7	P 1 1	R240013P

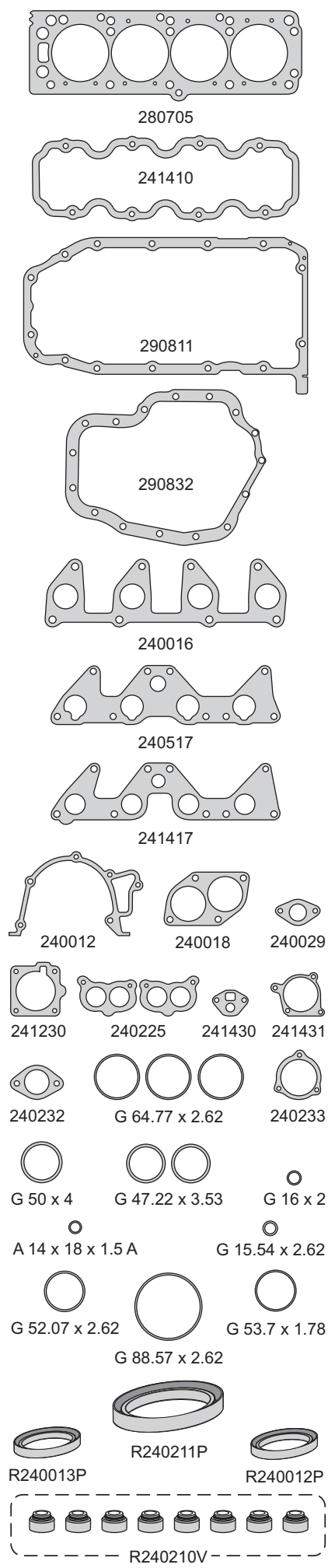

GM / CHEVROLET

CHEVROLET



Motor/Engine	Cm³	HP	Ø
OHC	1998	110/130	86
C20LE/C20NE	1998	97/110	86
C20NE/SEH/SER	1998	100/130	86
C20NEF	1998	100/130	86

Chevrolet: Omega MPFI - Vectra MPFI 1992/98
Daewoo: Lemans - Racer 1989/97
 Aranos 1995/... - Nubira II 1999/...
Opel: Frontera 1991/95 - Calibra - Cavalier
 Kadett 1986/91 - Astra 1991/96
 Omega A 1986/94

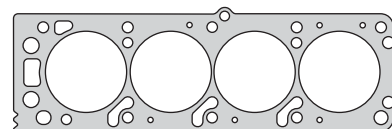

241507

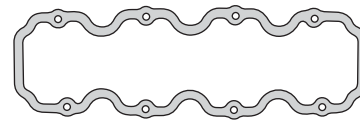

240010

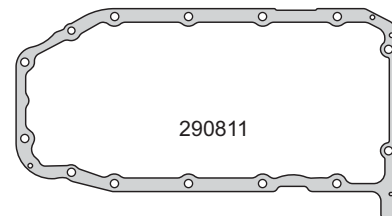

290811

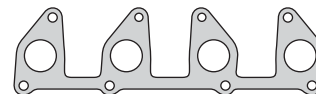

240016



240217

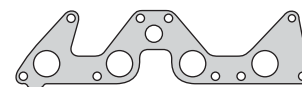

241417



240012



240025



240232



241431



290833



G 48 x 4



A 14 x 20 x 1.5 A



A 20 x 25 x 2 A



G 90 x 3



G 64.77 x 2.62



G 50 x 4



G 55.25 x 2.62



R240211P



R241515V



R240012P



R240013P

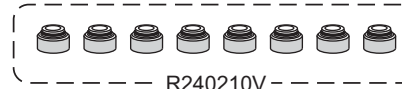

R240210V

Nº OE	Descripción/Description	Mat.	Ref.
	Jgo. de juntas para motor		241500-RMX
	Jgo. de juntas superior	●	241595
	Junta tapa cilindros Ø 88 ± 1.30 N.R.º	NFT 1 1	241507
	Jgo. de tornillos JTC (HAT55055/HAT55100)		B240000
652 635	Junta tapa de válvulas	CG 1 1	240010
	Junta para cárter superior	NFT 1 1	290811
	Bomba aceite y filtro a block	NB 1 1	240012
	Múltiple escape	NFT 1 1	240016
	Múltiple admisión	NB 1 1	240217
90128293	Múltiple admisión MPFI	NB 1 1	241417
	Base carburador	NB 2	240025
	Tubo separador bomba aceite	NB 1	240232
	Junta	NB 1	241431
	Junta	NB 1	290833
	Arandela A 14 x 20 x 1.5 A	AL 1	
	Arandela A 20 x 25 x 2 A	AL 1	
	O´ring G 48 x 4	GS 1	
	O´ring G 50 x 4	GS 1	
	O´ring G 55.25 x 2.62	GS 1 1	
	O´ring G 64.77 x 2.62	GS 1	
	O´ring G 90 x 3	GS 1	
	Kit de retenes completo		R241500
	Jgo. retén válvulas (8)	V 1	R240210V
	Retén bancada 90 x 104 x 11	P 1	R240211P
	Retén distribución 31 x 50 x 8	P 1	R240012P
636 841	Retén árbol de levas 35 x 48 x 7	P 1	R240013P
	Retén auxiliar 55 x 70 x 8	V 1	R241515V

GM / CHEVROLET

CHEVROLET



Motor/Engine	Cm³	HP	Ø
17D/DR	1700	57/60	82.5

Chevrolet: Astra 1991/94 - Vectra A 1989/95
Vauxhall: Astra Max 1990/... - Belmont 1989/91

DIESEL



Nº OE	Descripción/Description	Mat.	Ref.
	Jgo. de juntas para motor		241601-R
	Jgo. de juntas superior		241695
	Junta tapa cilindros Ø 84 \pm 1.30	NFT	241607-SM
	Junta tapa cilindros Ø 84 \pm 1.40	NFT	241607-1M
	Junta tapa cilindros Ø 84 \pm 1.50	NFT	241607-2M
	Jgo. de tornillos JTC (HAT55055/HAT55100)		B241700
90106506	Junta tapa válvulas	CG 1 1	240010
90106425	Junta para cárter	CG 1 1	240011
90106432	Bomba aceite y filtro a block	NB 1 1	240012
90106456	O'ring bomba de agua G 90 x 3	GS 1 1	240014
	Múltiple escape	NFT 1 1	241616
	Múltiple admisión	NB 1 1	241617
90122258	Nivel aceite	NB 1 1	240029
	Junta termostato	GS 1 1	560131
1169011	Arandela bomba aceite A 14 x 20 x 1.5 C	CU 2 2	240032
	Salida de escape	CHA 1 1	241640
	Arandela A 18 x 24 x 1.5 A	AL 1 1	
	Arandela A 14 x 22 x 2 C	CU 4 4	
	Arandela A 17 x 21 x 0.5 C	CU 4 4	
	O'ring G 15.54 x 2.62	GS 1 1	
	O'ring G 48 x 4	GS 1 1	
	Kit de retenes completo		R241600
	Jgo. retén válvulas (8)	P 1 1	R240010P
	Retén bancada 90 x 104 x 11	V 1 1	R240211V
	Retén árbol levas 35 x 48 x 7	V 1 1	R240013V
	Retén árbol levas 35 x 50 x 7	V 1 1	R470013V

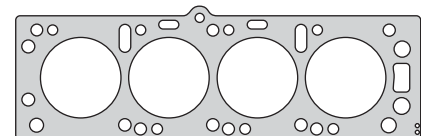

241607

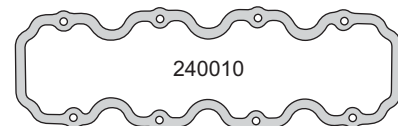

240010

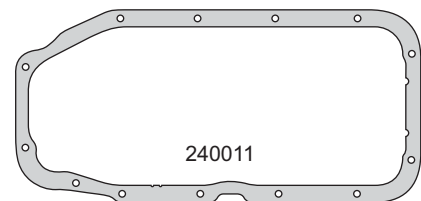

240011

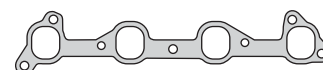

241616



241617

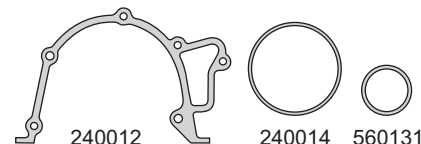

240012

240014

560131

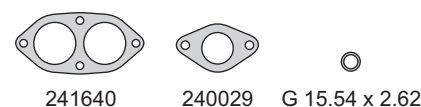

241640

240029

G 15.54 x 2.62

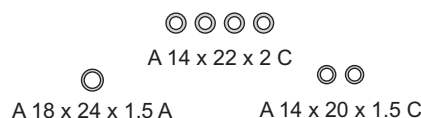

A 14 x 22 x 2 C

A 18 x 24 x 1.5 A

A 14 x 20 x 1.5 C

A 17 x 21 x 0.5 C

G 48 x 4



R240211V



R240013V



R470013V

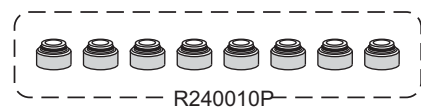

R240010P

GM / CHEVROLET

CHEVROLET



Motor/Engine	Cm³	HP	Ø
17DTL	1700	68	82.5

Chevrolet: Astra TD - Astra F TD 1994/97

DIESEL



Nº OE	Descripción/Description	Mat.		Ref.
	Jgo. de juntas para motor			241701-R
	Jgo. de juntas superior			241795
607464	Junta tapa cilindros Ø 84 \pm 1.30	NFT		241707-SM
607472	Junta tapa cilindros Ø 84 \pm 1.40	NFT		241707-1M
607466	Junta tapa cilindros Ø 84 \pm 1.50	NFT		241707-2M
	Jgo. de tornillos JTC (HAT55055/HAT55100)			B241700
638733	Junta tapa válvulas	N	1	241010
652586	Junta para cárter	CG	1	240011
	Junta para cárter	CG	1	240411
90106615	Junta bomba aceite y filtro a block	NB	1	240012
	Junta bomba aceite y filtro a block	NB	1	240412
90106456	O´ring bomba de agua G 90 x 3	GS	1	240014
5850616	Múltiple escape	NFT	1	241616
	Múltiple escape	NFT	1	240416
849511	Múltiple admisión	NB	1	241617
	Múltiple admisión	NB	1	241017
90122258	Junta nivel de aceite	NB	1	240029
	Descarga gases	NB	1	240429
	Arandela B18 x 24 x 2.3 CN	CN	1	450029
	Junta	CB	1	241230
1169011	Junta termostato	GS	1	560131
	Anillo	NB	1	241231
	Arandela bomba aceite A 14 x 20 x 1.5 C	CU	2	240032
	Arandela A 17 x 21 x 1.5 C	CU	4	
	Arandela inyección A 14 x 22 x 2 C	CU	4	
	O´ring G 48 x 4	GS	1	
642526	O´ring G 15.54 x 2.62	GS	1	
	O´ring G 79.5 x 3	GS	1	
	O´ring G 9.19 x 2.62	GS	1	
	Kit de retenes completo			R241700
614827	Jgo. retén válvulas (8)	V	1	R240210V
646266	Retén bancada 80 x 98 x 10	P	1	R240411V
	Retén distribución 35 x 50 x 7	P	1	R470013P
	Retén árbol levas 35 x 48 x 7	V	1	R240013V
	Retén distribución 26 x 42 x 8	V	1	R240415V

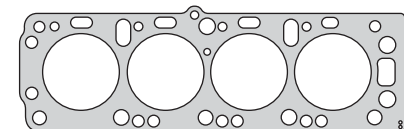

241707

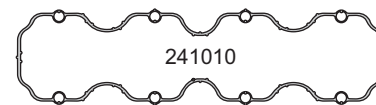

241010

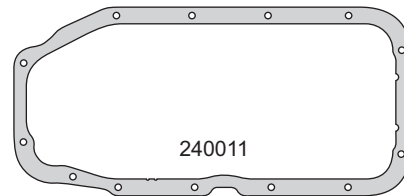

240011

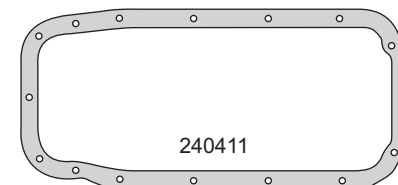

240411

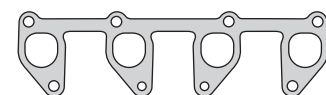

240416

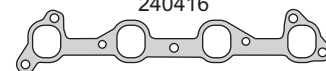

241616



241617

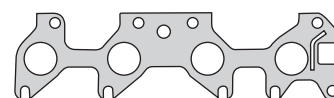

241017

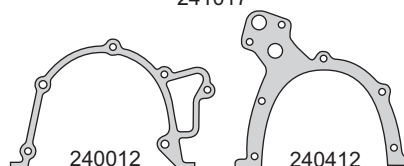

240012

240412

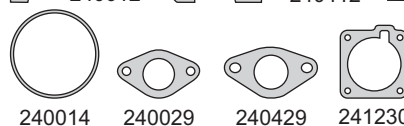

240014

240029

240429

241230

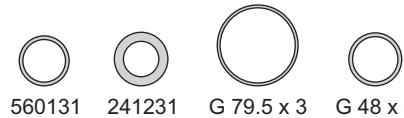

560131

241231

G 79.5 x 3

G 48 x 4



A 17 x 21 x 1.5 C

A 14 x 22 x 2 C

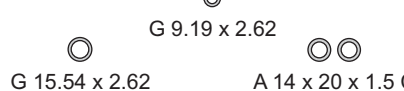

G 15.54 x 2.62

A 14 x 20 x 1.5 C



R240411V



R240013V



R470013P



R240415V

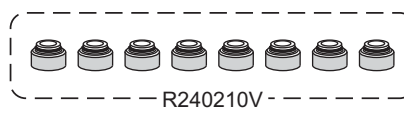

R240210V

CHEVROLET



Motor/Engine	Cm³	HP	Ø
L79 ALX (DOHC) 16V	1781	122	80.5

Chevrolet: Corsa II - Meriva 2003/...
Fiat: Palio Fase II 2004/...



Nº OE	Descripción/Description	Mat.	Ref.
	Jgo. de juntas para motor		● 241800-R MLS
	Jgo. de juntas superior (MLS)	●	241895 MLS
93294584	Junta tapa cilindros Ø 82 \pm 0.35 N.R. (HAE12038)	MLS	1 241808
90412701	Jgo. tornillos tapa cilindros (HAE12038)		B280600
7083391	Conj. junta tapa válvulas (11)	N	1 1 241810
93335205/1	Junta para cárter superior	NFT	1 290811
90573301	Frente motor bomba de aceite	SLS	1 241812
09158173	Bomba de agua G 79.5 x 3	GS	1 240414
90470036	Múltiple escape	NFT	1 1 280615
90536057	Múltiple admisión	SLS	1 1 241817
90231452	Salida de escape	FCH	1 1 240018
09157005	Guarnición base termostato G 60.05 x 1.78	GS	1 1 241819
90566088	Válvula aceleración	NB	1 1 241830
90536272	Junta válvula EGR	AC	1 1 241831
90220436	Guarnición termostato G 52.07 x 2.62	GS	1 1 241835
	O´ring G 10 x 2	GS	10 10
	Kit de retenes completo		R241800
90410741	Jgo. reten válvulas (16)	V	1 R280610V
90352111	Retén bancada 80 x 98 x 10	V	1 R240411V
90501719	Retén distribución 30 x 42 x 8	P	1 R550413P
90180529	Retén árbol levas 35 x 48 x 7	P	2 R240013P

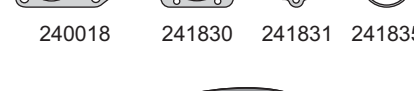
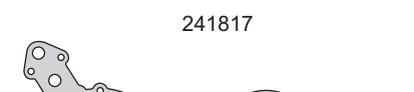
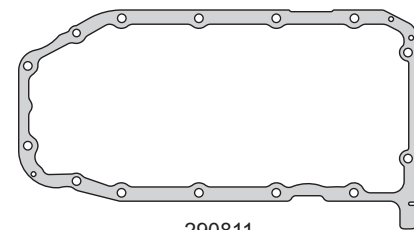
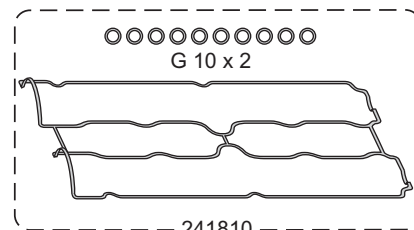
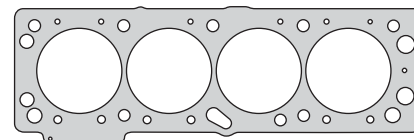

GM / CHEVROLET

CHEVROLET



Motor/Engine	Cm³	HP	Ø
172 V6 2da. Generación Cabeza de Aluminio	2800 3100		

Chevrolet: Cutlass - Century - Eurosport
Cavalier 1989/94



GM / CHEVROLET

Nº OE	Descripción/Description	Mat.		Ref.
	Jgo. de juntas para motor		●	241900-RMX
	Jgo. de juntas superior		●	241995
	Jgo. junta tapa cilin. Ø 91.5 ± 1.70 (2)	NFT	1 1	241905
	Conj. junta tapa válvulas (2)	GS	1 1	241910
	Junta para cárter	GS	1 1	241911
	Junta distribución	NB	1 1	241912
	Jgo. múltiple escape (2)	GFT	1 1	241915
	Jgo. múltiple admisión (4)	NFT	1 1	241917
	Junta	CB	1 1	290227
	Guarnición cierre admisión	GS	2 2	241930
	Junta	NB	1 1	241931
	Junta	GFT	1 1	290231
	Junta	NB	1 1	241932
	Junta	NB	1 1	241933
	Junta	CB	1 1	241934
	Junta	NB	1 1	241937
	Junta	NB	1 1	241938
	Junta	NB	1 1	241939
	Junta	NB	1 1	241940
	Arandela A 33 x 46	CB	1 1	280143
	Arandela tapa válvulas A 13 x 21 x 1.5 F	F	1 1	
	O´ring G 12.42 x 1.78	GS	1 1	
	O´ring G 23.39 x 3.53	GS	1 1	
	Guarnición G 7 x 10 x 2	GS	12 12	
	Kit de retenes completo			R241900
	Jgo. retén válvulas (12)	P	1 1	R241910P
	Retén bancada 76 x 92 x 10	P	1 1	R241911P
	Retén distribución 44.47 x 61.19 x 9.57	P	1 1	R200012P

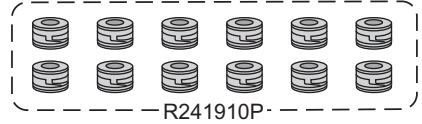
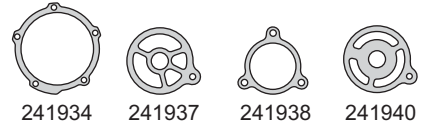
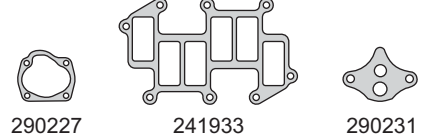
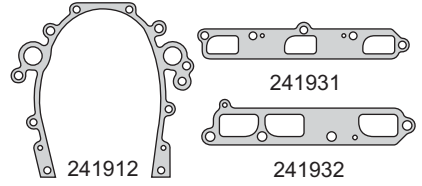
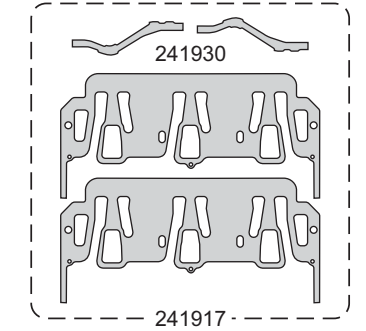
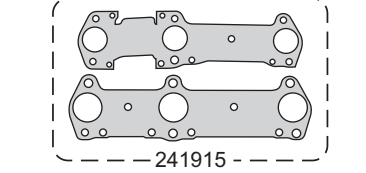
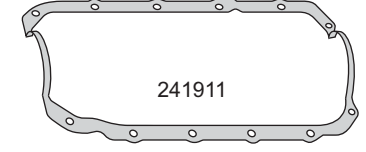
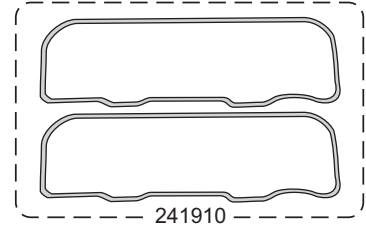
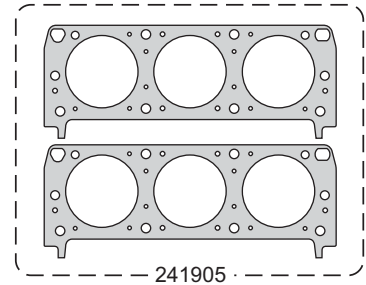

CHEVROLET



Motor/Engine	Cm³	HP	Ø
262 V6	4300		101.6

Chevrolet: Pick Up 1988/93



Nº OE	Descripción/Description	Mat.	Ref.
	Jgo. de juntas para motor		242100-RMX
	Jgo. de juntas superior	●	242195
	Jgo. jta. tapa cil. Ø105 ± 1.20 (2) N.R.	NFT	1 1 290607
	Jgo. junta tapa válvulas (2)	CG	1 1 242110
	Jgo. junta para cárter (4)	CG	1 1 242111
	Junta distribución	CB	1 1 280112
	Jgo. múltiple escape (6)	NFT	1 1 242116
	Jgo. múltiple admisión (2)	NFT	1 1 242117
	Jgo. múltiple admisión (2)	NFT	1 1 242117-1
	Salida de escape	NFT	1 1 242118
	Bomba de agua	CB	1 1 280119
	Base bomba nafta	CB	1 200028
	Base bomba aceite	NFT	1 280828
	Junta acople bomba aceite	CB	2 200029
	Guarnición	CG	1 1 242730
	Guarnición	CG	1 1 242731
	Junta	CB	1 242132
	Junta tapa inspección	CB	1 280132
	Junta porta retén	CB	1 280834
	Junta	AC	2 2 280835
	Junta	NB	1 242139
	Arandela A 33 x 46	CB	1 280143
	Junta	CB	1 280144
	Arandela A 12 x 16 x 2 A	AL	1
	O´ring G 15.54 x 2.62	GS	1
	O´ring G 64.77 x 2.62	GS	1
	Kit de retenes completo		R242100
	Jgo. retén válvulas (12)	P	1 R242110P
	Retén bancada 95 x 115 x 12.5	S	1 R242111S
	Retén distribución 44.47 x 61.19 x 9.57	P	1 R200012P

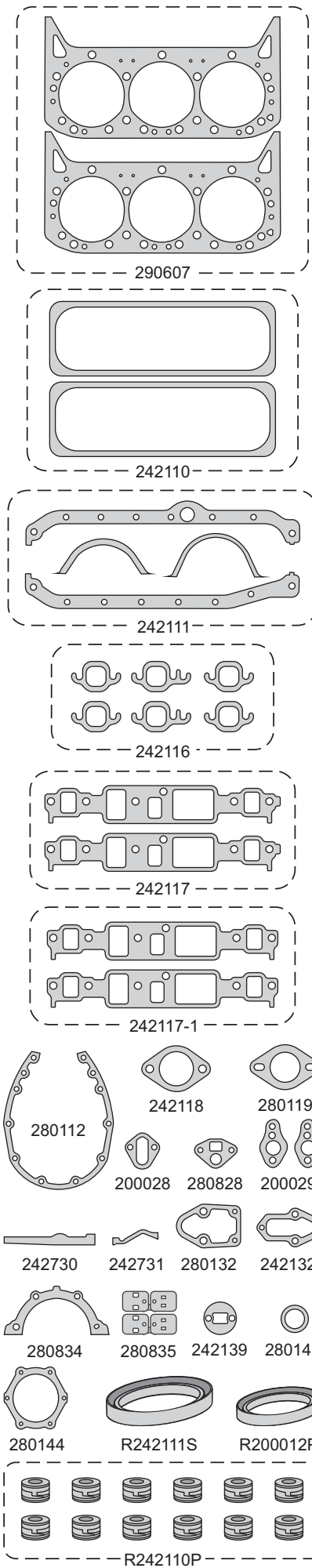

GM / CHEVROLET

CHEVROLET



Motor/Engine	Cm³	HP	Ø
GM Powertrain OHC 171190 MPFI 8V	1796 1796	102 102	80.5 80.5

Chevrolet: Corsa - Meriva 2003
Fiat: Stylo - Strada Working
 Adventure - Palio 2003



GM / CHEVROLET

Nº OE	Descripción/Description	Mat.	Ref.
	Jgo. de juntas para motor		242200-R
	Jgo. de juntas superior	●	242295
	Jgo. de juntas superior (MLS)		242295 MLS
	Junta tapa cilindros Ø 82 ± 1.40	NFT 1 1	242207
93294583	Junta tapa cilindros Ø 82 ± 1.40	MLS	242208
	Jgo. tornillos tapa cilindros (HAE12038)		B242200
	Junta tapa válvulas	N 1 1	241010
	Junta para cárter	CG 1 1	240411
	Frente motor bomba aceite	NB 1 1	240412
	Múltiple admisión y escape	NFT 1 1	240416
90106615	Múltiple admisión	NB 1 1	241017
7084890	Jgo. múltiple admisión entre colectores (4)	GS 1 1	252317
	Salida de escape	FCH 1 1	240018
7084981	Junta cuerpo mariposa aceleración	GS	242226
	Junta base termostato	N 1 1	240428
90128293	Salida gases 1.4	NB 1 1	240429
	Junta soporte inyección TBI	CB 1 1	241230
71716584	Guarnición admisión	GS 1 1	270731
	Junta acople admisión	GS 1 1	252332
	O'ring G 9.19 x 2.62	GS 1	
	O'ring G 79.5 x 3	GS 1	
	O'ring G 37.47 x 3	GS 1	
	Kit de retenes completo		R242200
	Jgo. retén válvulas (8)	V 1	R240210V
	Jgo. retén válvulas (8)	V 1	R242210V
	Retén bancada 80 x 98 x 10	V 1	R240411V
	Retén distribución 26 x 42 x 8	V 1	R240415V
	Retén árbol levas 35 x 48 x 7	V 1	R240013V

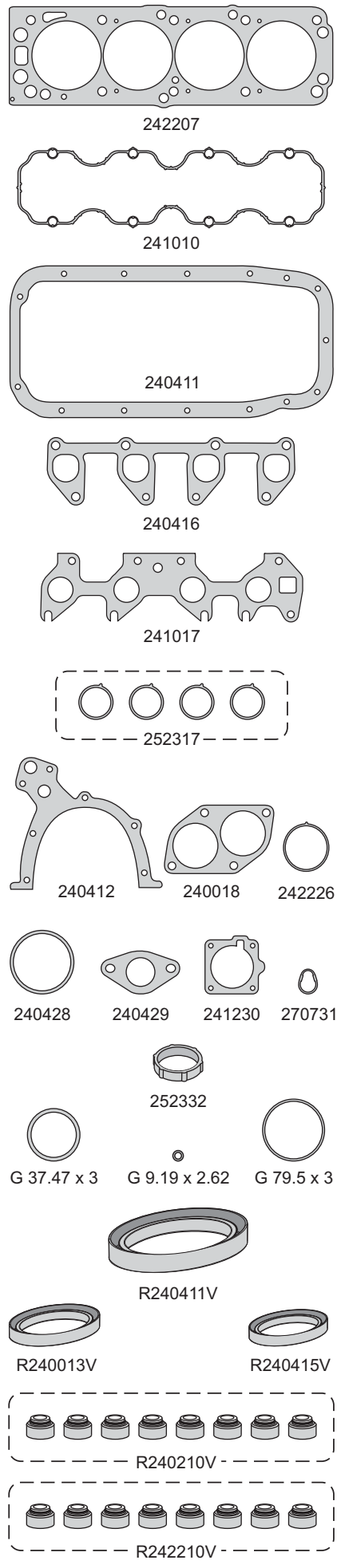

CHEVROLET



Motor/Engine	Cm³	HP	Ø
C16 SE 8V	1598	75/100	79
X16 SZR 8V	1598	75/100	79

Chevrolet: Corsa - Vectra - Kadett 1999/...



Nº OE	Descripción/Description	Mat.	Ref.
	Jgo. de juntas para motor		242300-R
	Jgo. de juntas superior		242395
	Junta tapa cilin. Ø 80.5 \pm 1.40 N.R.	NFT 1 1	240407
	Jgo. tornillos tapa cilindros (HAE12038)		B240400-1
	Junta tapa válvulas	N 1 1	241010
	Junta para cárter	CG 1 1	240411
	Frente motor bomba aceite	NB 1 1	240412
	Múltiple admisión y escape	NFT 1 1	240416
	Múltiple admisión GM Vectra - Kadett	NB 1 1	241017
	Múltiple admisión GM Corsa	NB 1 1	240617
	Junta termostato	GS 1 1	241219
	Junta base termostato	N 1 1	240428
	Salida gases 1.4	NB 1 1	240429
	Junta soporte inyección TBI	CB 1 1	241230
	Anillo goma	NB 1 1	241231
	O'ring G 79.5 x 3	GS 1 1	
	O'ring G 9.19 x 2.62	GS 1 1	
	Kit de retenes completo		R240400
	Jgo. retén válvulas (8)	V 1 1	R240210V
	Retén bancada 80 x 98 x 10	P 1 1	R240411P
	Retén distrib. bomba aceite 26 x 42 x 8	P 1 1	R240415P
	Retén árbol levas 35 x 48 x 7	P 1 1	R240013P

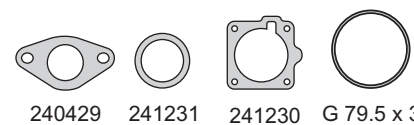
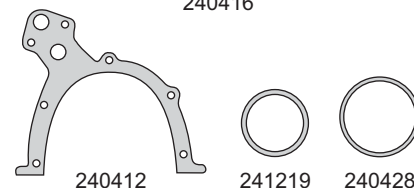
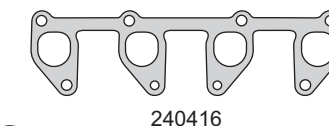
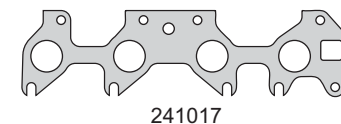
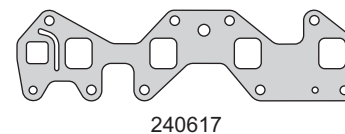
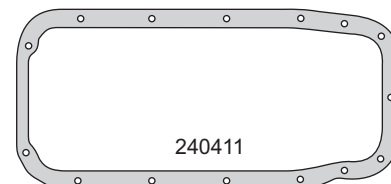
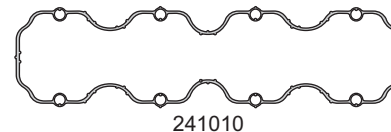
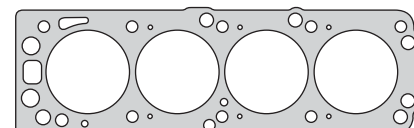

G 9.19 x 2.62

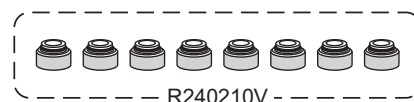
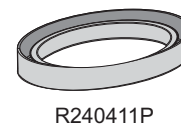

CHEVROLET



Motor/Engine	Cm³	HP	Ø
Y17 DIT/DTL Iny. Directa (DOHC) 16V	1686	65/75	79

Chevrolet: Corsa - Astra G DTI - Corsa C DI
Combo Tour TD 2000/...

DIESEL



Nº OE	Descripción/Description	Mat.	Ref.
	Jgo. de juntas para motor		242501-R
	Junta tapa cilindros Ø 80 ± 1.40 N.R.	NFT	242507-SM
	Junta tapa cilindros Ø 80 ± 1.50 N.R.	NFT	242507-1M
	Junta tapa cilindros Ø 80 ± 1.60 N.R.	NFT	242507-2M
97102350-SM	Junta tapa cilindros Ø 80 ± 1.40 N.R.	MLS	242508-SM
97102350-1M	Junta tapa cilindros Ø 80 ± 1.50 N.R.	MLS	242508-1M
97102350-2M	Junta tapa cilindros Ø 80 ± 1.60 N.R.	MLS	242508-2M
	Jgo. tornillos tapa cilin. (HAH10055/HAH10140)		B280200
97183007	Junta tapa válvulas	N	242510
	Junta para cárter superior	NFT	242511
	Bomba de agua	CB	280214
97219444	Múltiple escape	AC	242515
97218652	Múltiple admisión	NB	242517
97183214	Base porta termostato	NB	242519
	Junta filtro de aire	NB	280230
97183468	Junta caja porta árbol levas a tapa cilindros	SLS	242531
97313965	Junta caja porta árbol levas a tapa cil. - Meriva TD	SLS	242531-1
94457048	Tapa termostato	NB	242534
97218651	Entre colectores admisión	NB	242536
97185863	Cierre gases tapa válvulas	NB	242537
97189134	Guarnición base filtro de aceite	SLS	242538
94362672	Retorno aceite turbo a turbo	NB	242539
	Junta cárter inferior	NB	242541
	Arandela A 14 x 20 x 1.5 C	CU	
94000378	Arandela entrada agua A 20 x 28 x 1 C	CU	
94420097	O'ring sellador válvula G 14 x 2	GS	
90448217	O'ring llenado aceite G 37.47 x 3	GS	
	O'ring G 64.77 x 2.62	GS	
	Kit de retenes completo		R242500
	Jgo. retén válvulas (16)	V	1 R230510V
	Retén bancada trasera 87 x 100 x 8.5	V	1 R280211V
	Retén distribución 54 x 82 x 11.45	P	1 R242512P
	Retén árbol de levas 38 x 50 x 6	V	1 R452113V
	Retén bomba depresora 17.5 x 32 x 6	V	1 R280215V

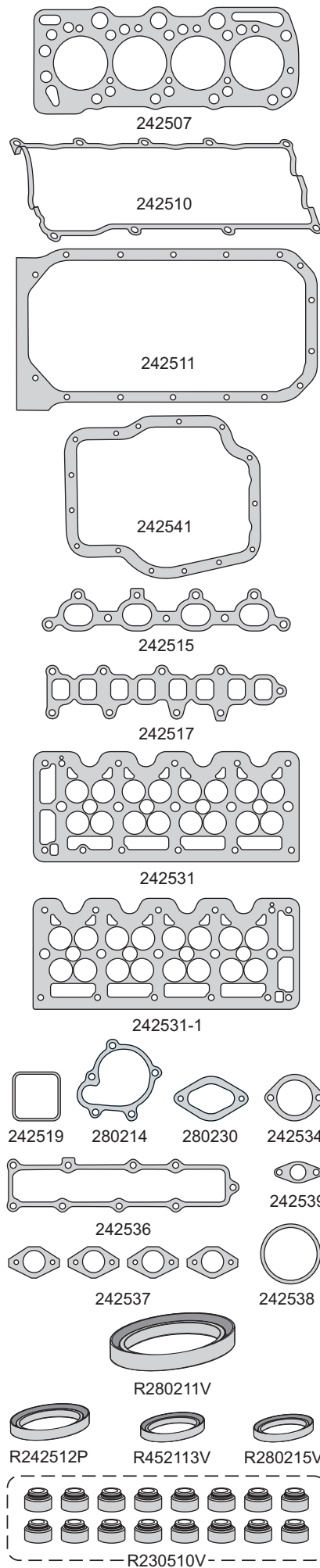

CHEVROLET



Motor/Engine	Cm³	HP	Ø
262 TK V6	4300		101.6

Chevrolet: Pick Up 1986/92



Nº OE	Descripción/Description	Mat.	Ref.
	Jgo. de juntas para motor		242700-RMX
	Jgo. de juntas superior	●	242795
	Jta. tapa cilindros Ø105 ± 1.20 (2)	NFT 1 1	290607
	Jgo. junta tapa válvulas (2)	GS 1 1	242710
	Junta para cárter	GS 1 1	242711
	Junta distribución	CB 1 1	280112
	Jgo. múltiple escape (6)	NFT 1 1	242116
	Jgo. múltiple admisión (4)	NFT 1 1	242117-1MX
	Salida de escape	FCH 1 1	540118
	Bomba de agua	CB 1 1	280119
	Junta base bomba nafta	CB 1 1	200028
	Junta EGR	NFT 1 1	280828
	Junta acople bba aceite	CB 2 2	200029
	Guarnición unión admisión	CG 1 1	242730
	Guarnición unión admisión	CG 1 1	242731
	Junta	CB 1 1	242732
	Junta tapa de inspección	CB 1 1	280132
	Junta	CB 1 1	242132
	Junta porta reten	CB 2 2	280834
	Junta	NB 1 1	242139
	Arandela A 33 x 46	CB 1 1	280143
	Junta	CB 1 1	280144
	Arandela A 12 x 16 x 2 A	AL 1 1	
	O´ring G 15.54 x 2.62	GS 1 1	
	O´ring G 66.27 x 3.53	GS 1 1	
	Kit de retenes completo		R242100
	Jgo. reten válvulas (12)	P 1 1	R242110P
	Reten bancada 95 x 115 x 12.5	S 1 1	R242111S
	Reten distribución 44.47 x 61.19 x 9.57	P 1 1	R200012P

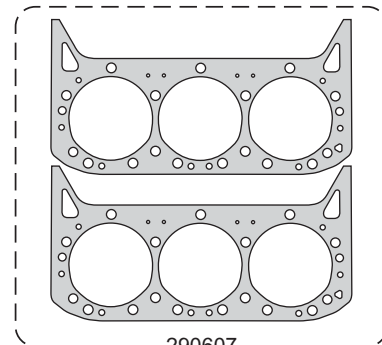

290607

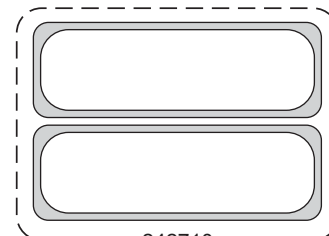

242710

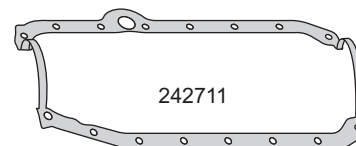

242711

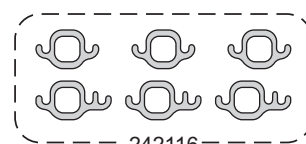

242116

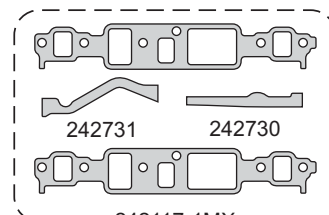

242731 242730

242117-1MX



280112



540118



280119



200028



280828



200029



242732



280132



242132



242139



280143



280834



280144



R242111S



R200012P



R242110P

GM / CHEVROLET

CHEVROLET



Motor/Engine	Cm³	HP	Ø
172 V6 Carburados	2800		

Chevrolet: Citation - Celebrity - Century
1982/86



GM / CHEVROLET

Nº OE	Descripción/Description	Mat.	1	2	Ref.	
	Jgo. de juntas para motor				242800-R	
	Jgo. de junta superior		●		242895	
	Jgo. junta tapa cilin. Ø 92.5 ± 1.20 (2)		NFT	1	1	242805
	Jgo. junta tapa válvulas (2)		CG	1	1	242810
	Jgo. junta para cárter (3)		CG		1	242811
	Tapa distribución		NB		1	241912
	Tapa distribución		CG		1	242813
	Bomba de agua		CB		1	242814
	Jgo. múltiple escape (3)		NFT	1	1	242816
	Jgo. múltiple admisión (4)		NFT	1	1	242817
	Junta bomba aceite		CB		1	290227
	Junta		NB		1	242830
	Guarnición cierre admisión		GS	2	2	241930
	Junta		NB		1	242831
	Junta		NB		1	242832
	Junta entre múltiples		NB		1	241933
	Junta		NB		1	242833
	Junta		CG		1	242834
	O'ring G 7 x 10 x 2		GS	12	12	
	O'ring G 23.39 x 3.53		GS		1	
	Kit de retenes completo					R242800
	Jgo. retén válvulas (12)		P		1	R242110P
	Retén bancada 76 x 92 x 10		P		1	R241911P
	Retén distribución 44.47 x 61.19 x 9.57		P		1	R200012P

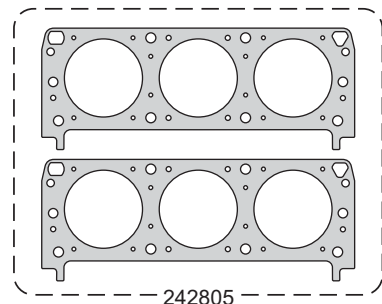

242805

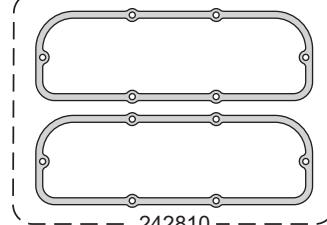

242810

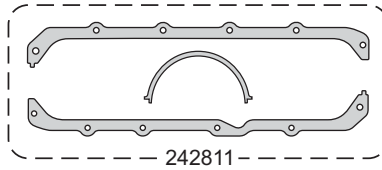

242811

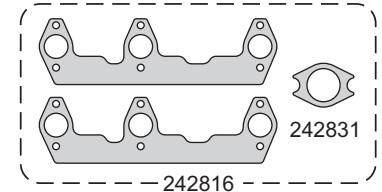

242816

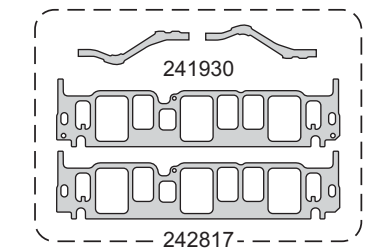

242817

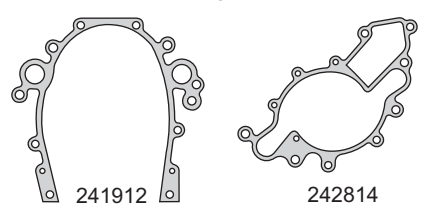

241912

242814

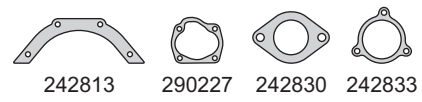

242813

290227

242830

242833

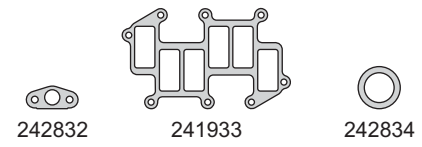

242832

241933

242834



G 7 x 10 x 2

G 23.39 x 3.53



R241911P

R200012P

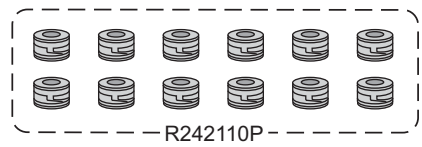

R242110P

CHEVROLET



Motor/Engine	Cm³	HP	Ø
L4 - 151	2500		

Chevrolet: Pontiac Vin E 1988/92



Nº OE	Descripción/Description	Mat.	Ref.
	Jgo. de juntas para motor		242900-RMX
	Jgo. de juntas superior		242995
	Jgo. junta tapa cilindros Ø 103 \pm 1.20	NFT 1 1	242905
	Junta tapa válvulas	CG 1 1	242910
	Jgo. junta para cárter (4)	CG 1 1	242911
	Tapa distribución	NB 1 1	200312
	Bomba de agua	NB 1 1	200014
	Bomba de agua	CB 1 1	242914
	Múltiple escape	NFT 1 1	242916
	Múltiple admisión	NFT 1 1	242917
	Salida de escape	NFT 1 1	242918
	Tapa bomba de aceite	NB 1 1	200327
	Junta bomba nafta	CB 1 1	200028
	E.G.R	NFT 1 1	280828
	Junta	NB 2 1	242930
	Junta	NB 1 1	242931
	Junta	CB 1 1	242933
	Junta	CG 1 1	242934
	Junta	CB 1 1	242935
	Junta	CG 1 1	242936
	Junta	NB 1 1	242937
	Válvula E.G.R	NFT 1 1	280839
	Junta	CB 1 1	290343
	O'ring G 40.94 x 2.62	GS 1 1	
	O'ring G 7 x 10 x 2	GS 4 1	
	O'ring G 6.07 x 1.78	GS 1 1	
	Kit de retenes completo		R242900
	Jgo. retén válvulas (4)	P 1 1	R242910P
	Retén bancada 75.9 x 95 x 11.3	P 1 1	R200811P
	Retén distribución 44,47 x 61.19 x 9,57	N 1 1	R200012N

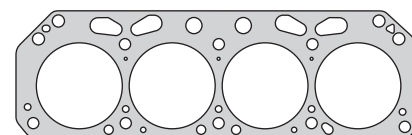

242905

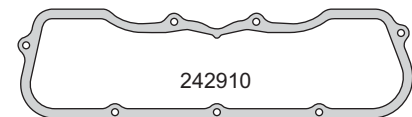

242910

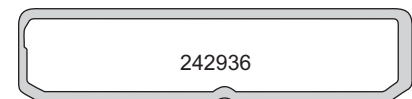

242936

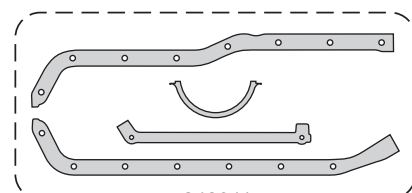

242911



242916



242917

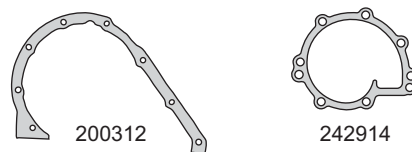

200312

242914

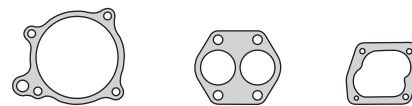

200014

242918

200327

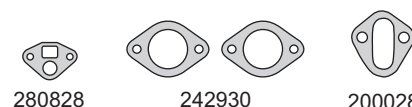

280828

242930

200028

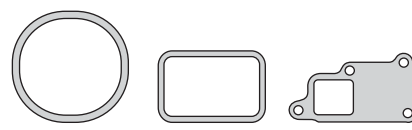

242933

242934

242935

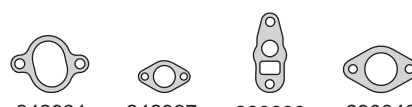

242931

242937

280839

290343



G 6.07 x 1.78

G 40.94 x 2.62



R200811P

R200012N



G 7 x 10 x 2

R242910P

GM / CHEVROLET

CHEVROLET



Motor/Engine Cm³ HP Ø

MPFI VHC 999 60 71.1

Chevrolet: Celta - Classic - Corsa 2003/...

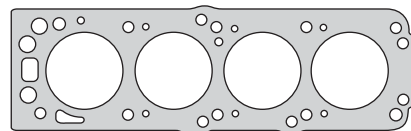

240908

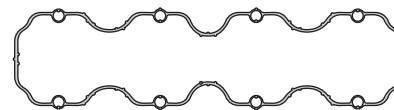

241010

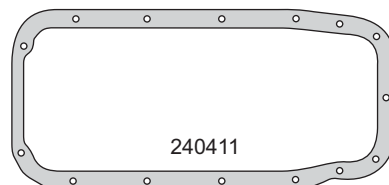

240411

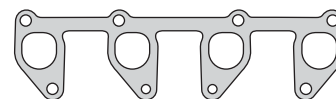

240416

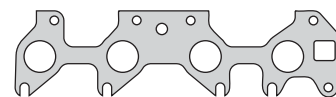

241017

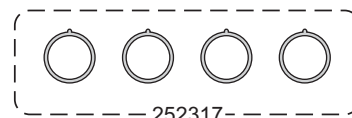

252317

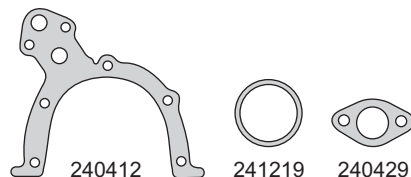

240412

241219

240429



241230



241231



G 79.5 x 3



G 9.19 x 2.62



R240013P



R240415P



R240411P

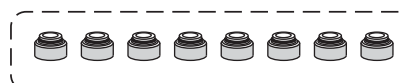

R240210V

Nº OE	Descripción/Description	Mat.	Ref.
	Jgo. de juntas para motor		● 243300-R MLS
	Jgo. de juntas superior (MLS)	●	243395 MLS
	Jta. tapa cilindros Ø 74 ± 1.40 N.R.	MLS 1 1	240908
	Jgo. tornillos tapa cilindros (HAE12038)		B240400-1
	Junta tapa válvulas	N 1 1	241010
	Junta para cárter	CG 1	240411
	Frente motor bomba aceite	NB 1	240412
	Múltiple admisión y escape	NFT 1 1	240416
	Múltiple admisión	NB 1 1	241017
	Jgo. múltiple admisión (4)	GS 1 1	2523017
	Junta termostato	GS 1	241219
	Salida gases 1.4	NB 1 1	240429
	Junta soporte inyección TBI	CB 1 1	241230
	Anillo goma	NB 1	241231
	O'ring G 79.5 x 3	GS 1	
	O'ring G 9.19 x 2.62	GS 1	
	Kit de retenes completo		R240400
	Jgo. retén válvulas (8)	V 1	R240210V
	Retén bancada 80 x 98 x 10	P 1	R240411P
	Retén árbol levas 35 x 48 x 7	P 1	R240013P
	Retén distrib. bomba aceite 26 x 42 x 8	P 1	R240415P

GM / CHEVROLET

CHEVROLET



Motor/Engine	Cm³	HP	Ø
Powertrain	2405	147	87.5

Chevrolet: Astra 2004/... - S10 2005/...
Vectra 2006/...



Nº OE	Descripción/Description	Mat.	Ref.
	Jgo. de juntas para motor		● 243400-R MLS
	Jgo. de juntas superior (MLS)		● 243495 MLS
56 07 409	Jta. tapa cilindros Ø 89 \pm 1.40	NFT	1 1 243408
607 647	Conj. tapa de válvulas (11)	N	1 1 280710
652 635	Junta para cárter superior	NFT	1 1 290811
	Bomba aceite filtro a block	NB	1 1 240012
90220436	O´ring bomba de agua G 88.57 x 2.62	GS	1 1 280614
850 656	Múltiple escape	NFT	1 1 280715
850 655	Múltiple admisión	NB	1 1 280717
854 933	Salida de escape	FCH	1 1 240018
	Placa admisión	NFT	1 1 280729
	Guarnición goma termostato G 44.17 x 1.78	GS	1 1 280730
	Guarnición goma termostato G 66.4 x 1.78	GS	1 1 280731
652 636	Junta para cárter inferior	CG	1 1 290832
	Nivel aceite	SLS	1 1 280733
	Junta	NB	1 1 290833
	Junta	NB	1 1 290834
	Junta	CG	1 1 290835
	Arandela A 14 x 20 x 1C	CU	1 1
	Arandela A 20 x 24 x 1.5 A	AL	1 1
	O´ring G 9 x 2	GS	10 10
	O´ring G 15.54 x 2.62	GS	1 1
	O´ring G 16 x 2	GS	1 1
	O´ring G 47.22 x 3.53	GS	2 1
	O´ring G 50 x 4	GS	1 1
	O´ring G 52.07 x 2.62	GS	1 1
	O´ring G 53.7 x 1.78	GS	1 1
	O´ring G 64.77 x 2.62	GS	3 1
	Kit de retenes completo		R280700
642 533	Jgo. retén válvulas (16)	V	1 1 R280610V
614 827	Retén bancada 90 x 104 x 11	V	1 1 R240211V
646 265	Retén distribución 31 x 50 x 8	V	1 1 R240012V
636 841	Retén árbol de levas 35 x 48 x 7	V	2 1 R240013V

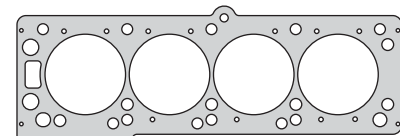

243408

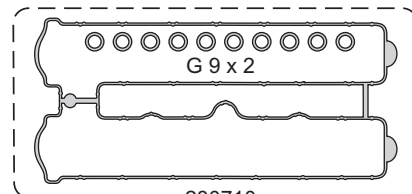

280710

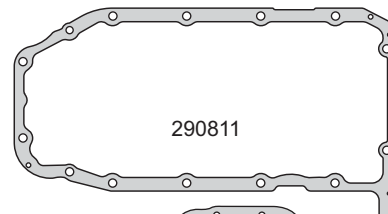

290811

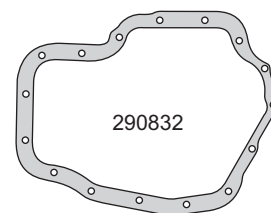

280715



280717

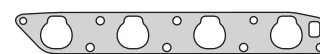

240012

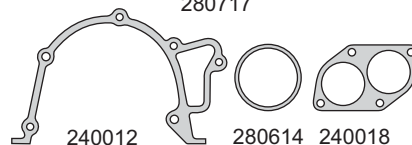

280614



240018



280729



280730



280731



280733



290832



280733



290833



290834



290835

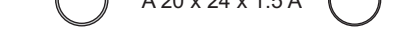

G 50 x 4



G 64.77 x 2.62



G 47.22 x 3.53



A 20 x 24 x 1.5 A



G 52.07 x 2.62



G 53.7 x 1.78



G 15.54 x 2.62

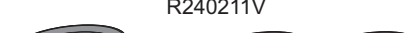

G 16 x 2



A 14 x 20 x 1 C



R240211V



R240012V



R240013V



R280610V

CHEVROLET



Motor/Engine	Cm³	HP	Ø
X17 DTL 8V	1700	68	82.5

Chevrolet: Astra TD 1994/97
Astra GTD 1998/00
Motor 1455260 08/1994

DIESEL



Nº OE	Descripción/Description	Mat.	1	2	Ref.
	Jgo. de juntas para motor				243501-R
	Jgo. de juntas superior				243595
5607443	Junta tapa cilindros Ø 84 \pm 1.30	MLS			243508-SM
5607444	Junta tapa cilindros Ø 84 \pm 1.40	MLS			243508-1M
5607445	Junta tapa cilindros Ø 84 \pm 1.50	MLS			243508-2M
	Jgo. de tornillos JTC (HAT55055/HAT55100)				B241700
638192	Junta tapa válvulas	GS	1	1	241410
652608	Junta para cárter superior	NB		1	243511
652609	Junta para cárter inferior	NB		1	243532
90106615	Frente bomba aceite a block	NB	1	1	240012
90106456	O'ring bomba de agua G 90 x 3	GS		1	240014
850608	Múltiple escape	NFT	1	1	241616
850616	Múltiple admisión	NB	1	1	241617
90122268	Junta válvula nivel de aceite	NB		1	240029
	Arandela B 18 x 24 x 2.3 CN	CN			450029
	Junta termostato	GS	1	1	560131
854929	Salida de escape	CHA	1	1	241640
	O'ring G 48 x 4	GS	1	1	
	O'ring G 15.54 x 2.62	GS	1	1	
469011	Arandela bomba aceite A 14 x 20 x 1.5 A	CU		2	
	Arandela inyectores A 14 x 22 x 2 C	CU	4	4	
	Arandela A 17 x 21 x 6.5 C	CU	4	4	
	Kit de retenes completo				R241600
642526	Jgo. retén válvulas (8)	P		1	R240010P
614827	Retén bancada 90 x 104 x 11	V		1	R240211V
646266	Retén distribución 35 x 48 x 7	V		1	R240013V
646290	Retén árbol levas 35 x 50 x 7	V		1	R470013V

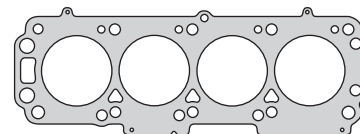

243508

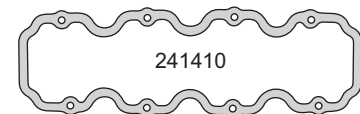

241410

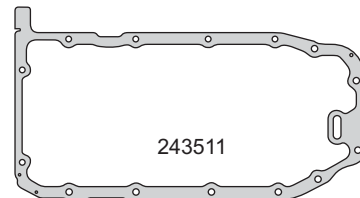

243511

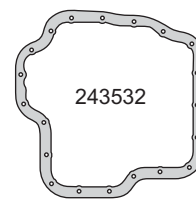

243532

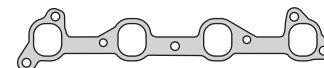

241616



241617



240012

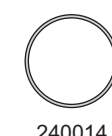

240014



240029



560131



241640



G 15.54 x 2.62



A 18 x 24 x 2.3



G 48 x 4



A 14 x 22 x 2 C



A 14 x 20 x 1.5 A

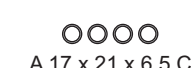

A 17 x 21 x 6.5 C



R240211V



R240013V



R470013V

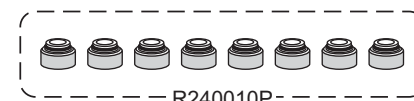

R240010P

CHEVROLET



Motor/Engine	Cm³	HP	Ø
X14SE/Y14NE MPFI (SOHC) 8V	1389	90/92	77.6

Chevrolet: Corsa Econoflex - Classic - Agile
Celta 2006/2009 - 2009/...



Nº OE	Descripción/Description	Mat.	Ref.
	Jgo. de juntas para motor		244000-R
	Jgo. de juntas superior		244095
	Junta tapa cilindros Ø 79 \pm 1.80	NFT	1 1 241007-1.80
	Jgo. tornillos tapa cilindros (HAE12038)		B244000
7083232	Junta tapa de válvulas	N	1 1 241010
	Junta cárter con control de compresibilidad	CG	1 240411
7083280	Frente motor y bomba de aceite	SLS	1 241812
	O'ring cierre bomba de agua G 79.5 x 3	GS	1 240414
93396858	Múltiple escape	AC	1 1 240415
90571863	Múltiple admisión	NB	1 1 241017
7084980	Jgo. múltiple admisión (4)	GS	1 1 252317
73502844	Salida de escape catalizador	AC	1 1 252318
90128293	Salida de escape	FCH	240018
	Junta termostato	GS	1 241219
7084981	Junta cuerpo mariposa aceleración	GS	1 1 252326
	Junta soporte inyección TBI	CB	1 241230
7083288	Descarga gases	NB	1 240429
7086225	Conducto agua admisión a EGR	GS	1 1 270731
	Guarnición acople admisión	GS	1 1 252332
7083229	Guarnición tapa llenado de aceite G 38 x 4	GS	1 1
	Kit de retenes completo		R244000
7083335	Jgo. retén válvulas (8)	V	1 R244010V
7084149	Retén bancada 80 x 98 x 10	V	1 R240411V
90280463	Retén árbol de levas 35 x 48 x 7	V	1 R240013V
90501719	Retén distribución 26 x 42 x 8	V	1 R240415V

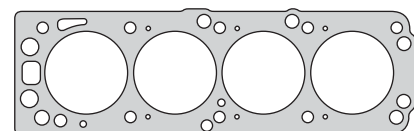

241007-1.80

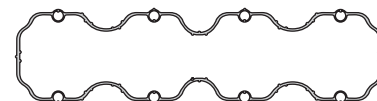

241010

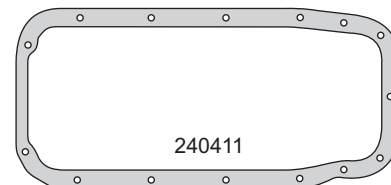

240411

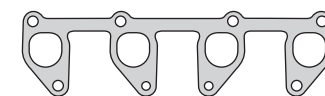

240415

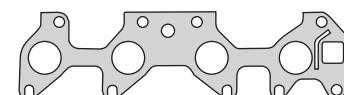

241017

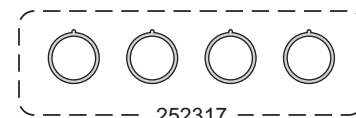

252317

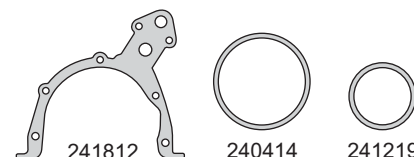

241812

240414

241219

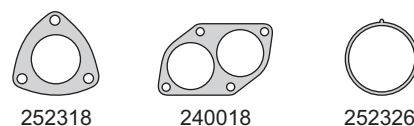

252318

240018

252326

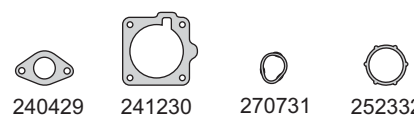

240429

241230

270731

252332



G 38 x 4



R240411V



R240013V



R240415V

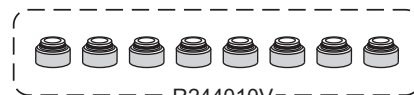

R244010V

GM / CHEVROLET

CHEVROLET



Motor/Engine Cm³ HP Ø

N18XFN 1796 108 80.5

Chevrolet: Spin - Cobalt



GM / CHEVROLET

Nº OE	Descripción/Description	Mat.	Ref.
	Jgo. de juntas para motor	●	244100-R MLS
	Junta tapa cilindros Ø 82 \times 1.40 N.R.	NFT	242207
93294583	Junta tapa cilindros Ø 82 \times 1.40 N.R.	MLS	1 242208
90409594	Junta tapa válvulas	N	1 241010
90573301	Frente motor bomba de aceite	SLS	1 241812
09158173	O´ring bomba de agua G 79.5 x 3	GS	1 240414
24579972	Múltiple admisión y escape	AC	1 240415
7084890	Jgo. múltiple admisión entre colectores (4)	GS	1 252317
94733773	Salida de escape	AC	1 244118
73502844	Salida de escape catalizador	AC	1 252318
90128293	Salida gases 1.4	NB	1 240429
93278411	O´ring tapa de válvulas G 64.5 x 2.6	GS	1
90190637	O´ring G 15.3 x 2.4	GS	1
	Kit de retenes completo		R244100
90410741	Jgo. retén válvulas (8)	V	1 R242210V
24578614	Retén bancada 80 x 98 x 10	V	1 R240411V
90511719	Retén distribución 26 x 42 x 8	V	1 R240415V
90180529	Retén árbol levas 35 x 48 x 7	V	1 R240013V

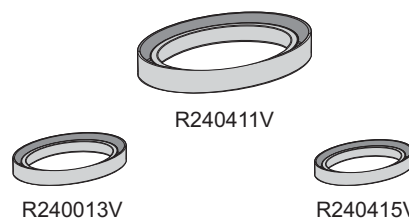
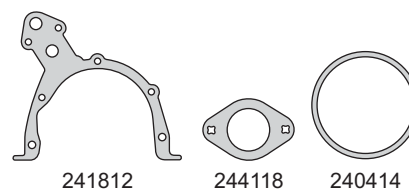
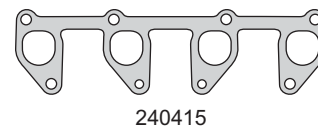
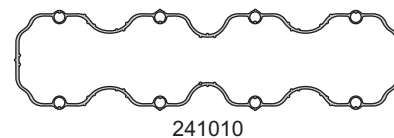
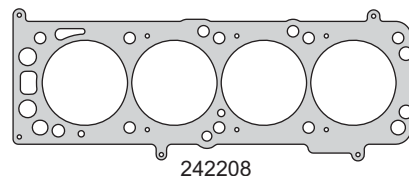

CHEVROLET



Motor/Engine	Cm³	HP	Ø
SPE/4	999	80	71.1

Chevrolet: Prisma - Onix



Nº OE	Descripción/Description	Mat.	Ref.
	Jgo. de juntas para motor		● 244200-R MLS
93221445	Junta tapa cilindros Ø 74 \pm 1.40	MLS	1 240908
	Jgo. tornillos tapa cilindros (HAE12038)		B242200
24578675	Junta tapa válvulas	GS	1 244210
90573301	Frente motor bomba de aceite	SLS	1 241812
09158173	O´ring bomba de agua G 79.5 x 3	GS	1 240414
24579972	Múltiple admisión y escape	AC	1 240415
7084890	Jgo. múltiple admisión entre colectores (4)	GS	1 252317
94733773	Salida de escape	AC	1 244118
90128293	Salida gases 1.4	NB	1 240429
	Kit de retenes completo		R244100
90410741	Jgo. retén válvulas (8)	V	1 R242210V
24578614	Retén bancada 80 x 98 x 10	V	1 R240411V
90511719	Retén distribución 26 x 42 x 8	V	1 R240415V
90180529	Retén árbol levas 35 x 48 x 7	V	1 R240013V

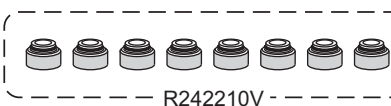
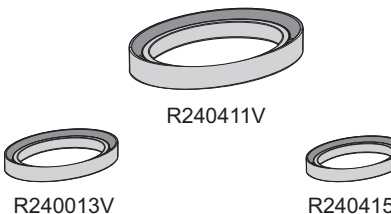
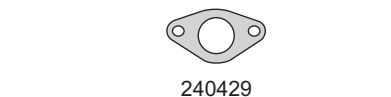
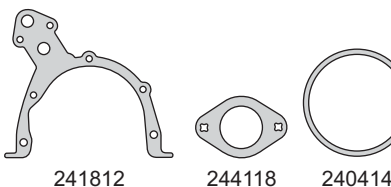
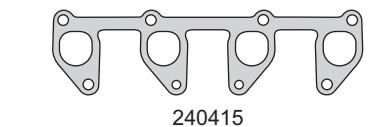
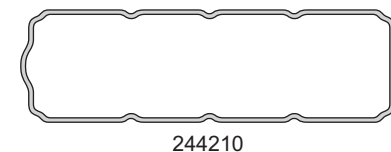
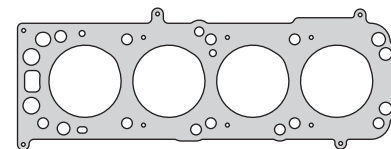

GM / CHEVROLET

CHEVROLET



Motor/Engine	Cm ³	HP	Ø
SPE/4	1389	106	77.6

Chevrolet: Prisma - Onix



GM / CHEVROLET

Nº OE	Descripción/Description	Mat.	Ref.
	Jgo. de juntas para motor		244300-R MLS
93346293	Junta tapa cilindros Ø 79 \times 1.80	MLS	1 241007-1.80
	Jgo. tornillos tapa cilindros (HAE12038)		B242200
24578675	Junta tapa válvulas	GS	1 244210
90573301	Frente motor bomba de aceite	SLS	1 241812
09158173	O´ring bomba de agua G 79.5 x 3	GS	1 240414
24579972	Múltiple admisión y escape	AC	1 240415
7084890	Jgo. múltiple admisión entre colectores (4)	GS	1 252317
94733773	Salida de escape	AC	1 244118
90128293	Salida gases 1.4	NB	1 240429
	Kit de retenes completo		R244100
90410741	Jgo. retén válvulas (8)	V	1 R242210V
24578614	Retén bancada 80 x 98 x 10	V	1 R240411V
90511719	Retén distribución 26 x 42 x 8	V	1 R240415V
90180529	Retén árbol levas 35 x 48 x 7	V	1 R240013V

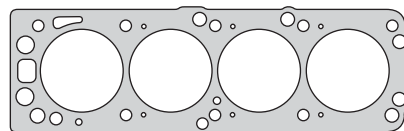

241007-1.80



244210

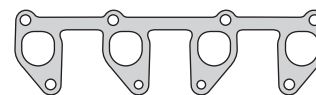

240415



252317

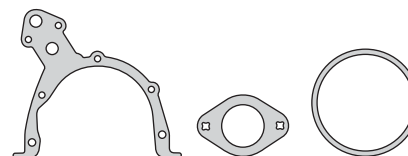

241812

244118

240414

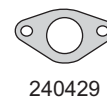

240429



R240411V



R240013V



R240415V

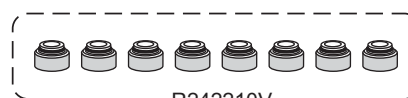

R242210V

CHEVROLET



Motor/Engine	Cm³	HP	Ø
C18NE/NV	1796	90	84.5
C18NZ	1796	90	84.5

Chevrolet: Monza - Kadett 1986/91
Astra 1991/97 - Vectra 1989/95



Nº OE	Descripción/Description	Mat.	Ref.
	Jgo. de juntas para motor		280000-R
	Jgo. de juntas superior		280095
	Junta tapa cilindros Ø 86.2 ± 1.40	NFT 1 1	240005
90122951	Jgo. de tornillos JTC (HAT55055/HAT55100)		B240000
	Junta tapa válvulas	CG 1 1	240010
90220309	Junta para cárter	N 1 1	240211
90124295	Block a filtro	NB 1 1	240012
90106432	O'ring tapa bomba de agua G 90 x 3	GS 1 1	240014
90106456	Múltiple escape	NFT 1 1	240016
90106615	Múltiple admisión	NB 1 1	240217
90215011	Múltiple admisión	NFT 1 1	240517
	Salida de escape	FCH 1 1	240018
90128293	O'ring carcasa termostato G 50 x 4	GS 1 1	240019
90118437	Base carburador	NB 2 2	240025
94624122	O'ring G 16 x 2.5	GS 1 1	240027
94632563	Base bomba nafta	NB 2 2	550628
90265732	Nivel aceite	NB 1 1	240029
90122258	O'ring tubo G 64 x 3	GS 1 1	240030
90128513	Arandela A 20 x 24 x 1.5 A	AL 1 1	240031
105462	Arandela bomba aceite A 14 x 20 x 1.5 A	AL 2 2	240032
11069511	O'ring termostato 55.25 x 2.62	GS 1 1	240033
	Arandela tapón cárter B 14 x 18 x 2 CN	CN 1 1	150034
	Arandela A 14 x 18 x 1.5 A	AL 1 1	
	O'ring termostato G 47 x 4	GS 1 1	
	Kit de retenes completo		R240200
	Jgo. retén válvulas (8)	V 1 1	R240210V
	Retén bancada 90 x 104 x 11	P 1 1	R240211P
	Retén distribución 31 x 50 x 8	P 1 1	R240012P
	Retén árbol levas 35 x 48 x 7	P 1 1	R240013P

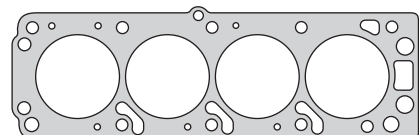

240005

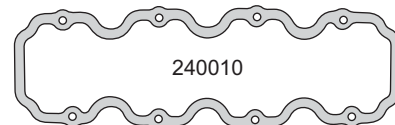

240010

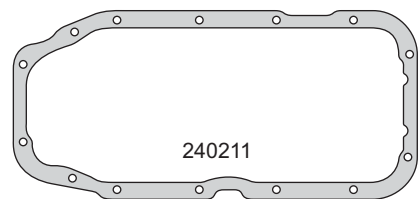

240211

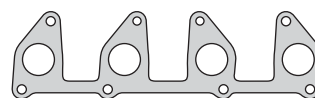

240016



240217



240517



240012



240014

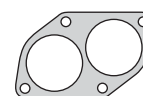

240018

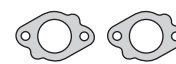

240025



G 16 x 2.5

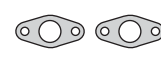

550628



240029



G 64 x 3



G 50 x 4



G 47 x 4



A 14 x 18 x 1.5 A



A 14 x 20 x 1.5 A

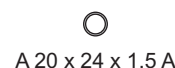

A 20 x 24 x 1.5 A



R240012P



R240211P



R240013P



R240210V

GM / CHEVROLET

CHEVROLET



Motor/Engine
GM C350 V8



Cm³
5735

HP

Ø
101.6

Chevrolet: 283 - 302 - 307 - 327 Carburador
327 - 350 No Corvette
350 - Pick Up y Medianos
283 - 307 - 327 Camiones 1967/...



GM / CHEVROLET

Nº OE	Descripción/Description	Mat.	Ref.
	Jgo. de juntas para motor		280100-R
	Jgo. junta tapa cilindros Ø 105 ±1.20 (2)	NFT	1 280105
	Junta tapa válvulas	CG	2 280110
	Jgo. junta para cárter (7)	CG	1 280111
	Tapa distribución	CB	1 280112
	Jgo. múltiple escape (2)	NFT	1 280116
	Jgo. múltiple admisión (4)	NFT	1 280117
	Salida de escape	FCH	2 200018
	Salida de escape	NFT	280118
	Codo termostato	CB	280119
	Tapa bomba aceite	CB	280127
	Base bomba nafta	CB	1 200028
	Acople bomba aceite	CB	1 200029
	Base termostato	CB	280131
	Tapa inspección	CB	1 280132
	Puntera cierre admisión Chevrolet C-350	N	1 280133
	Puntera cierre admisión Chevrolet C-350	N	1 280134
	Sello metálico admisión	AC	280135
	Acople escape	NFT	280136
	Subida aceite	NFT	280137
	Bajada aceite	NFT	280138
	Arandela A 33 x 46	CB	1 280143
	Arandela A 67 x 80	CB	280142
	Junta	CB	1 280144
	Junta	CB	1 280145
	Junta	CB	1 280146
	Arandela A 129 x 140	CB	280139
	Arandela A 106 x 116	CB	280140
	Arandela A 78 x 90	CB	280141
	Arandela tapón cárter A 12.8 x 22.8 x 2	PLAST	
	Kit de retenes completo		R280100
	Jgo. retén válvulas (16)	P	1 R280110P
	Retén bancada (2 mitades)	S	1 R200011-1S
	Retén distribución 44.47 x 61.19 x 9.57	P	1 R200012P

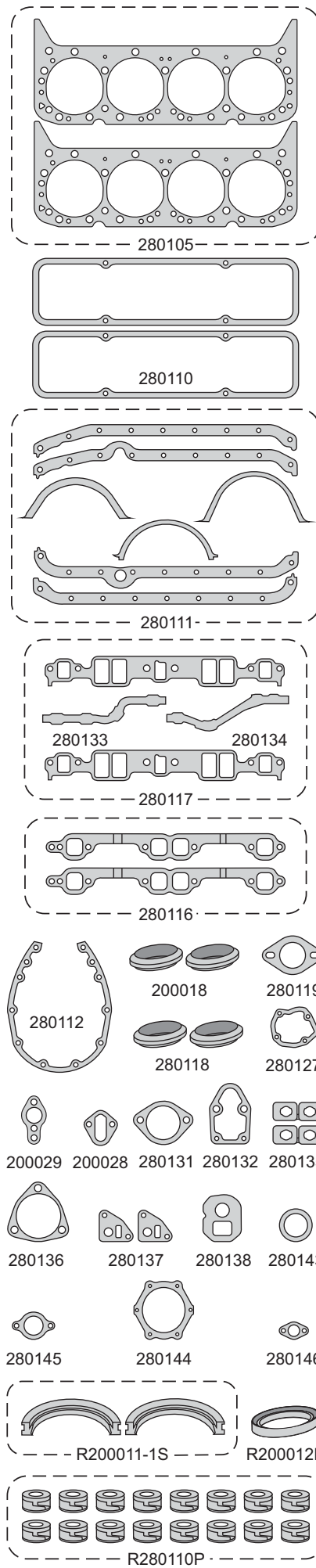

CHEVROLET



Motor/Engine	Cm³	HP	Ø
4EE1	1686	60	79
4EE1T	1686	82	79

Chevrolet: Corsa D - Combo D 1997/...
Vectra TD 1991/96 - Astra TD 1994/97



DIESEL

Nº OE	Descripción/Description	Mat.	Ref.
	Jgo. de juntas para motor		280201-R
	Jgo. de juntas superior		280295-SM
	Jgo. de juntas superior		280295-1M
	Jgo. de juntas superior		280295-2M
	Jgo. de juntas superior (MLS)		280295-SM MLS
	Jgo. de juntas superior (MLS)		280295-1M MLS
	Jgo. de juntas superior (MLS)		280295-2M MLS
608.805	Junta tapa cilindros Ø 81 \geq 1.40	NFT	1 280207-SM
608.806	Junta tapa cilindros Ø 81 \geq 1.50	NFT	280207-1M
608.804	Junta tapa cilindros Ø 81 \geq 1.60	NFT	280207-2M
	Jta. tapa cilindros Ø 80.5 \geq 1.40	MLS	280208-SM
	Jta. tapa cilindros Ø 80.5 \geq 1.50	MLS	280208-1M
	Jta. tapa cilindros Ø 80.5 \geq 1.60	MLS	280208-2M
	Jgo. de tornillos JTC (HAH10055/HAH10140)		B280200
	Conj. junta tapa de válvulas (2)	GS	1 1 280210
	Junta para cárter	NB	1 280211
	Bomba de agua	CB	1 280214
	Múltiple escape	NFT	1 1 280215
	Múltiple admisión	NB	1 1 280217
	Termostato	NB	1 1 280219
	Cámara de agua	NB	1 1 280229
	Filtro de aire	NB	1 1 280230
	Inspección tapa cilindros	NB	1 1 280231
	Retorno agua	NB	1 1 280232
	Guarnición cierre	GS	280233
	Bomba de agua	CB	280234
	O'ring bomba de aceite G 63.5 x 3	GS	1 280235
	Guarnición G 56.5 x 66.5 x 6	GS	1 280236
	Guarnición buje bomba de aceite G 17 x 24 x 9	GS	1 280237
	Guarnición medialuna árbol levas	GS	1 1 280238
	O'ring G 23.52 x 1.78	GS	1
	O'ring G 17.17 x 1.78	GS	1
	O'ring G 16.5 x 3	GS	1
	O'ring G 10.77 x 2.62	GS	1
	Arandela A 14 x 20 x 1.5 C	CU	1
	Arandela A 12 x 17 x 2 C	CU	1
	Arandela A 8 x 14 x 1 C	CU	2
	Kit de retenes completo		R280200
	Jgo. retén válvulas (8)	V	1 R280210V
	Retén bancada 87 x 100 x 8.5	V	1 R280211V
	Retén distribución 40 x 52 x 6	V	2 R280212V
	Retén bomba depresora 17.5 x 32 x 6	V	1 R280215V

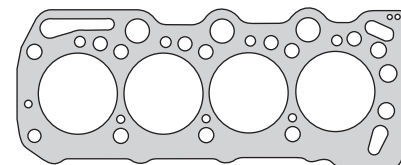

280207

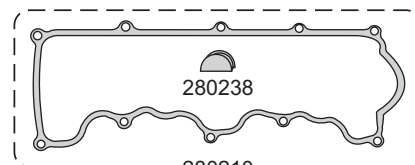

280238



280210

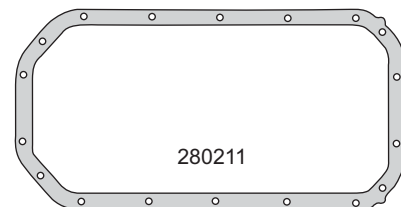

280211



280215



280217



280214



280219



280229



280230



280231



280232



G 23.52 x 1.78



G 17.17 x 1.78



G 10.77 x 2.62

G 63.5 x 3



G 16.5 x 3



G 17 x 24 x 9

G 56.5 x 66.5 x 3



A 12 x 17 x 2 C



A 14 x 20 x 1.5 C

A 8 x 14 x 1 C



R280211V

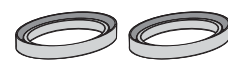

R280212V



R280215V

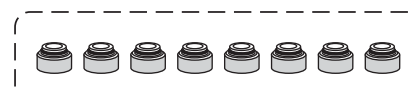

R280210V

GM / CHEVROLET

CHEVROLET



Motor/Engine **Cm³** **HP** **Ø**

Maxion S4 **3990** **102** **100**

Chevrolet: GM D20 - D40 - Pick Up D20

DIESEL



Nº OE	Descripción/Description	Mat.		Ref.
	Jgo. de juntas para motor			280300-R
	Jgo. de juntas superior		●	280395
3681E016	Jta. tapa cilindros Ø 105 \pm 1.80		NFT	1 1 280307
	Jgo. de tornillos para tapa de cilindros			B280300
7049258	Conj. junta tapa válvulas (5)		N	1 1 280310
70490178	Junta para cárter		CG	1 280311
70490259	Tapa distribución		NB	1 280312
36814137	Placa distribución		NB	1 410613
70490255	Bomba de agua cuerpo trasero		NB	1 280314
36886007	Jgo. múltiple escape (2)		NFT	1 1 280316
	Jgo. múltiple admisión (3)		NFT	1 1 280317
70490144	Bomba de agua a block		NB	1 410719
36853514	Cuerpo salida agua		NB	1 1 410632
36862538	Adaptador al aceite		NB	1 410433
36851409	Tapa trasera tapa cilindros		NB	1 1 410633
36834143	Registro bomba inyectora		NB	1 400435
36817157	Porta retén bancada trasera		NB	1 400236
70490257	Codo a motor a múltiple		NB	1 1 280336
70490254	Conexión agua a tapa termostato		NB	1 1 280337
33817132	Arandela cierre tapa válvulas		GS	280340
70490145	Cuerpo delantero y trasero bomba de agua		NB	1 410640
	Anillo goma especial		GS	280341
36851113	Bomba alimentación a block		NB	1 410642
36832122	Tubo succión vacío		NB	1 410643
0490773	Bomba inyectora		NB	1 400146
	Guarnición cierre tapa válvulas		GS	4 4 400446
36865511	Adaptador vacío		NB	1 410747
	Jgo. gomas (13)		GS	1 1 280348
	Junta colector a escape turbo		AC	1 350462
70920104	Arandelas inyector A 7.5 x 15 x 2 C		CU	4 4
	Arandela A 6 x 9 x 1 C		CU	8 8
	Arandela A 8 x 12 x 1 C		CU	2
	Arandela A 10 x 15 x 1.5 A		AL	3
	Arandela A 15 x 21 x 1.5 A		AL	4 4
	Arandela A 17 x 22 x 1.25 A		AL	3
	Arandela A 22.5 x 29 x 2 A		AL	1
	Arandela A 13 x 17 x 2 A		AL	1
	Arandela A 20 x 28 x 1 A		AL	1
	Anillo G 41.5 x 47.5 x 7		GS	1 1
	Anillo G 6 x 10.5 x 5.8		GS	1 1
	Anillo G 73 x 82 x 9.7		GS	1 1
	O´ring G 15.6 x 1.78		GS	4 4
	O´ring G 18.77 x 1.78		GS	2 2
	O´ring G 15.5 x 30 x 12.5		GS	4 4
	Kit de retenes completo			R280300
	Jgo. retén válvulas (8)		P	1 R280310P
	Jgo. retén válvulas (8)		P	1 R300310P
	Retén distribución 60.32 x 79.36 x 9.5		P	1 R400012P
	Retén bancada 133.35 x 158.75 x 11/13		V	1 R400211V

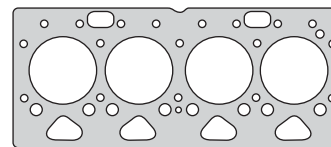

280307

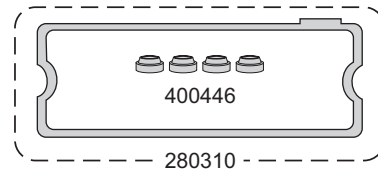

400446

280310

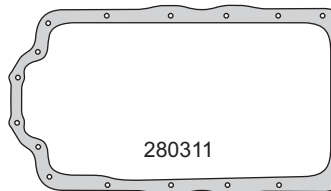

280311



280317

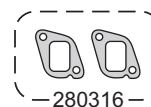

280316

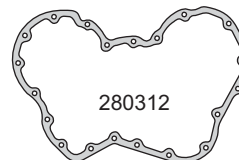

280312



410613

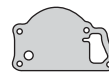

410719



280314



410632



410433

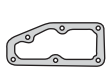

410633

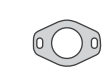

400435



280336

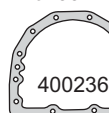

400236



280337



410640



410642

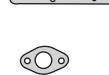

410643

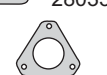

400146



410747



350462



A 15 x 21 x 1.5 A



A 17 x 22 x 1.25 A



A 10 x 15 x 1.5 A



G 15.6 x 1.78



G 18.77 x 1.78



A 22.5 x 29 x 2 A



A 6 x 9 x 1 C



A 7.5 x 15 x 2 C



A 20 x 28 x 1 A



A 8 x 12 x 1 C



A 13 x 17 x 2 A



G 41.5 x 47.5 x 7



R400211V



R400012P



R280310P



R300310P

GM ISUZU



Motor/Engine	Cm³	HP	Ø
4ZD1	2254	88	89.3

Isuzu: Luv - Pick Up 1986/92

DIESEL



Nº OE	Descripción/Description	Mat.	Ref.
	Jgo. de juntas para motor		280400-R
	Junta tapa cilindros Ø 91 \pm 1.70	NFT	1 280407
	Jgo. tornillos tapa cilin. (HAH10055/HAH10140)		B280400
	Conj. junta tapa válvulas (4)	GS	1 280410
	Jgo. junta para cárter	GS	1 280411
	Base distribución	CB	1 280413
6403172711	Bomba de agua	NB	1 280414
6403122721	Múltiple escape	CHA	1 280415
6403172881	Múltiple admisión	NB	1 280417
	Base carburador	CB	2 280425
	Base filtro aceite	NB	1 280427
	Codo termostato	NB	280431
	Junta	NB	1 280430
	Tapa termostato	NB	1 280432
	Arandela fijación tapa de válvulas	GS	3 280433
	O'ring G 64.77 x 2.62	GS	1
	O'ring G 35 x 3.5	GS	1
	O'ring G 7.52 x 3.53	GS	8
	Kit de retenes completo		R280400
	Jgo. retén válvulas (8)	V	1 R280410V
	Retén bancada 95 x 118 x 8.5	P	1 R240711P
	Retén distribución 40 x 56 x 7	P	1 R260312P
	Retén árbol levas 30 x 45 x 8	P	1 R240713P
	Retén bomba de aceite 25 x 40 x 8	N	1 R280415N

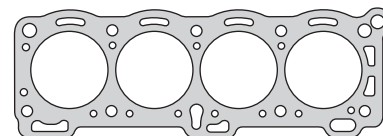

280407

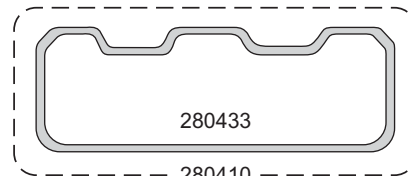

280433

280410

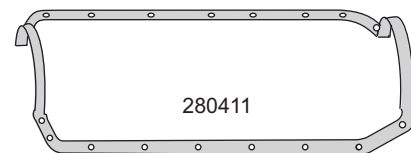

280411



280415



280417

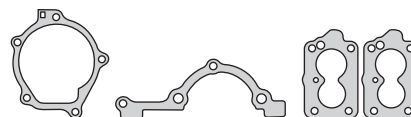

280414

280413

280425



280427

280430

280431

280432



G 64.77 x 2.62



G 35 x 3.5



G 7.52 x 3.53



R240711P



R260312P



R240713P



R280415N



R280410V

GM / CHEVROLET

CHEVROLET



Motor/Engine Cm³ HP Ø

MPFI (DOHC) 16V 999 68 71.1

Chevrolet: Corsa 1998/...



GM / CHEVROLET

Nº OE	Descripción/Description	Mat.	Ref.
	Jgo. de juntas para motor		280500-R
	Jgo. de juntas superior	●	280595
	Jta. tapa cilindros Ø 74 \pm 1.40 N.R.º	NFT 1 1	280507
	Jgo. tornillos tapa cilindros (HAE12038)		B280600
638 737/736	Conj. juntas tapa válvulas (12)	N 1 1	280610
652669	Junta para cárter	N 1 1	280611
	Frente motor bomba aceite	NB 1 1	240412
5850613	Múltiple escape	NFT 1 1	280615
850668	Múltiple admisión	NB 1 1	280617
90128293	Salida de escape	FCH 1 1	240018
	Termostato	NFT 1 1	280519
	Junta TBI	CB 1 1	280530
5850612	Entre múltiples colectores X16XE	NB 1 1	280634
5050611	Entre múltiple colectores X16XE	NB 1 1	280637
	O'ring G 9 x 2	GS 10 10	
	O'ring G 55.25 x 2.62	GS	1
	O'ring G 60.05 x 1.78	GS	1
	O'ring G 64 x 3	GS	1
	O'ring G 79.5 x 3	GS	1
	Arandela A 14 x 19 x 1.5 C	CU	4
	Kit de retenes completo		R280600
036/109675//	Jgo. retén válvulas (16)	V 1 1	R280610V
614830	Retén bancada 80 x 98 x 10	V 1 1	R240411V
636 841	Retén árbol levas 35 x 48 x 7	V 2 2	R240013V
646274	Retén bomba aceite 26 x 42 x 8	V 1 1	R240415V

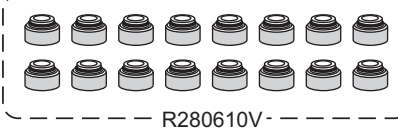
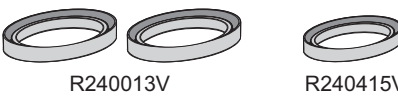
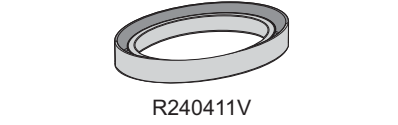
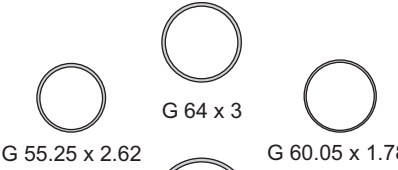
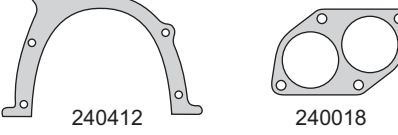
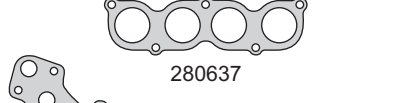
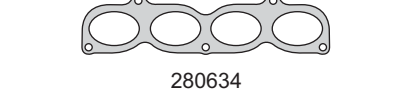
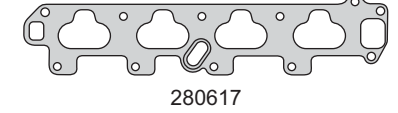
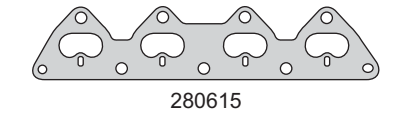
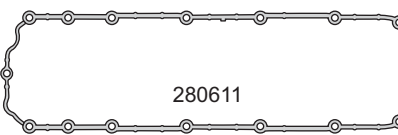
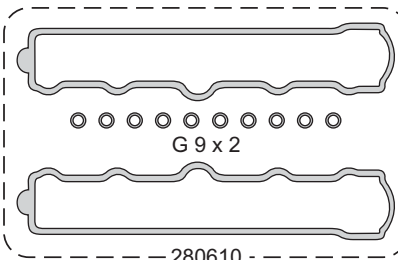
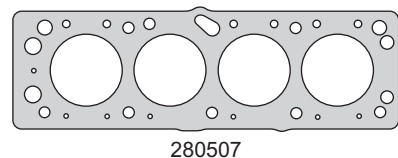

CHEVROLET



Motor/Engine	Cm³	HP	Ø
C16XE - C16XEL (DOHC) 16V	1598	109	79

Chevrolet: Corsa - Opel - Tigra
Astra - Vectra 1993/...



Nº OE	Descripción/Description	Mat.	Ref.
	Jgo. de juntas para motor		280600-R
	Jgo. de juntas superior		280695
91 06 305	Jta. tapa cilindros Ø 80.5 ± 1.30	NFT	1 1 280607
	Jgo. tornillos tapa cilindros		B280600
638 737/736	Conj. junta tapa válvulas (12)	N	1 1 280610
652669	Junta para cárter	N	1 1 280611
	Frente distribución	NH	280612
	Frente bomba aceite	NB	1 240412
90220436	O´ring bomba de agua G 88.57 x 2.62	GS	1 280614
5850613	Múltiple escape	NFT	1 1 280615
850668	Múltiple admisión	NB	1 1 280617
90118437	O´ring termostato G 50 x 4	GS	1 240019
	Anillo termostato	GS	1 240419
	Descarga gases	NB	1 240429
90412738	Guarnición termostato	GS	280629
	Salida gases		280630
5850612	Entre múltiples colectores X16XE	NB	1 1 280634
5050611	Entre múltiple colectores X16XE	NB	1 1 280637
	O´ring G 9 x 2	GS	10 10
	O´ring G 60.05 x 1.78	GS	1 1
	O´ring distribución G 15.54 x 2.62	GS	1
	Arandela A 14 x 22 x 2 C	CU	4
	Arandela A 17 x 21 x 0.5 C	CU	4
	Kit de retenes completo		R280600
642 533	Jgo. retén válvulas (16)	V	1 R280610V
614830	Retén bancada 80 x 98 x 10	V	1 R240411V
636 841	Retén árbol levas 35 x 48 x 7	V	2 R240013V
646274	Retén bomba aceite 26 x 42 x 8	V	1 R240415V

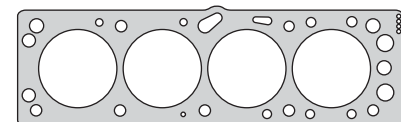

280607

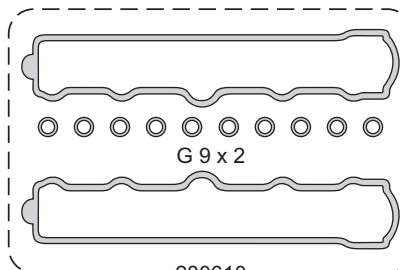

G 9 x 2

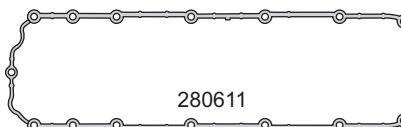

280611



280615

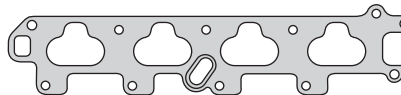

280617



280634



280637

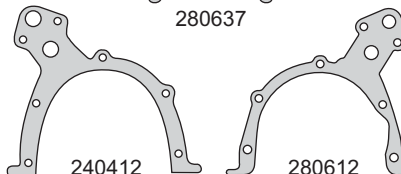

240412

280612

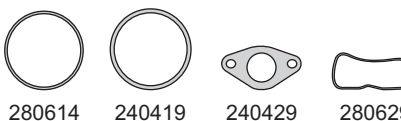

280614

240419

240429

280629



280630

G 15.54 x 2.62

G 50 x 4



A 14 x 22 x 2 C

A 17 x 21 x 0.5 C



R240411V



R240013V

R240415V

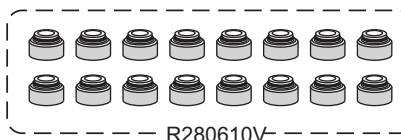

R280610V

GM / CHEVROLET

CHEVROLET



Motor/Engine	Cm³	HP	Ø
X20XEV	1998	136	86
X20SED	1998	136/148	86
X20SED (DOHC) 16V	2198	140	86

Chevrolet: Astra 1995/...
Omega B - Calibra 1994/...

Daewoo: Leganza 1997/... - Nubira 1997/...
Nubira II 1999/... - Magnus 2001/...



Nº OE	Descripción/Description	Mat.	Ref.
	Jgo. de juntas para motor		280700-R
	Jgo. de juntas superior	●	280795
	Jta. tapa cilindros Ø 88 ± 1.40	NFT	280705
56 07 449	Jta. tapa cilindros Ø 88 ± 1.40	NFT	280707
	Jgo. de tornillos JTC (HAT55055/HAT55100)		B280700
607 647	Conj. junta tapa de válvulas (11)	N	280710
	Junta para cárter	N	240211
652 274	Junta para cárter con rompeolas	CHA	280711
	Bomba aceite filtro a block	NB	240012
850 655	Múltiple escape	NFT	280715
850 656	Múltiple admisión	NB	280717
854 933	Salida de escape	FCH	240018
	Placa admisión	NFT	280729
	Guarnición goma termostato G 44.17 x 1.78	GS	280730
	Guarnición goma termostato G 66.4 x 1.78	GS	280731
	Nivel aceite	SLS	280733
	Arandela A 14 x 20 x 1 C	CU	
	Arandela A 20 x 24 x 1.5 A	AL	
	O´ring G 9 x 2	GS	10
	O´ring G 16 x 2.5	GS	1
	O´ring G 17.17 x 1.78	GS	1
	O´ring G 94 x 3	GS	1
	Kit de retenes completo		R280700
642 533	Jgo. retén válvulas (16)	V	1
614 827	Retén bancada 90 x 104 x 11	V	1
646 265	Retén distribución 31 x 50 x 8	V	1
636 841	Retén árbol de levas 35 x 48 x 7	V	2

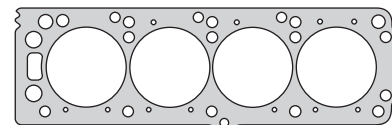

280707

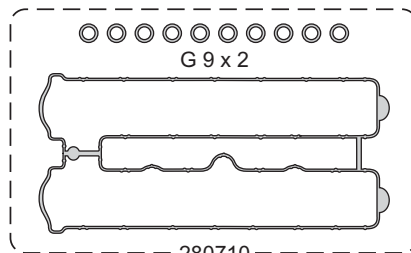

G 9 x 2

280710

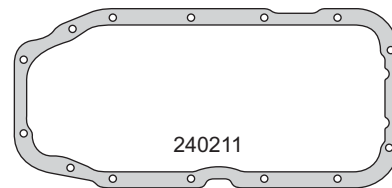

240211

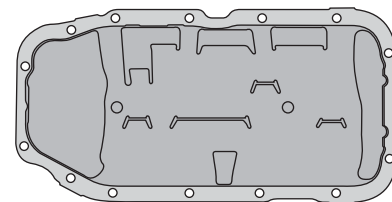

280711

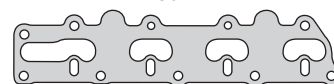

280715

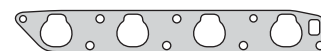

280717



240012

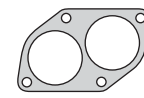

240018

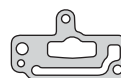

280729



280730



280731



280733



G 94 x 3



A 14 x 20 x 1C



G 16 x 2.5



G 17.17 x 1.78



A 20 x 24 x 1.5 A



R240211V



R240013V



R240012V

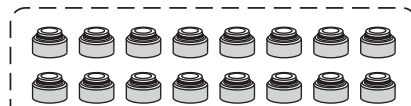

R280610V

CHEVROLET



Motor/Engine **C350L V8** Cm³ **5735** HP Ø **101.6**

Chevrolet: 350 1986/93 No Corvette
Pick Up - Camiones 350 1986/95



Nº OE	Descripción/Description	Mat.	Ref.
	Jgo. de juntas para motor	●	280800
	Jgo. junta tapa de cilindros Ø 105 ± 1.20 (2)	NFT	1 280105
	Junta tapa válvulas	CG	2 280110
	Junta tapa válvulas	GS	2 281110
	Jgo. junta para cárter (2)	CGT	1 280811
	Tapa distribución	CB	1 280112
	Jgo. múltiple escape (2)	NFT	1 280116
	Jgo. múltiple escape (4)	NFT	1 280816
	Jgo. múltiple admisión (4)	NFT	1 280117
	Jgo. múltiple admisión (2)	NFT	1 280817
	Salida de escape	FCH	2 200018
	Codo termostato	CB	1 280119
	Tapa bomba aceite	CB	1 280127
	Base bomba nafta	CB	1 200028
	E.G.R	NFT	1 280828
	Acople bomba aceite	CB	2 200029
	Tapa inspección	CB	1 280132
	Cierre admisión	N	1 280133
	Salida gases	CB	1 280833
	Cierre admisión	N	1 280134
	Porta retén	CB	1 280834
	Sello metálico admisión	AC	2 280835
	Base carburador	CB	1 280837
	Base carburador	CB	1 280838
	Válvula E.G.R	NFT	1 280839
	Tapa filtro aire carburador A 129 x 140 x 1.6	CB	2 280139
	Llenado aceite A 33 x 46 x 0.8	CB	1 280143
	Arandela tapón cárter A 13 x 23 x 1.5 C	CU	1
	Anillo G 82.2 x 91 x 4.75	GS	1
	Anillo G 85.5 x 3.35	GS	1
	Anillo G 85 x 3	GS	1

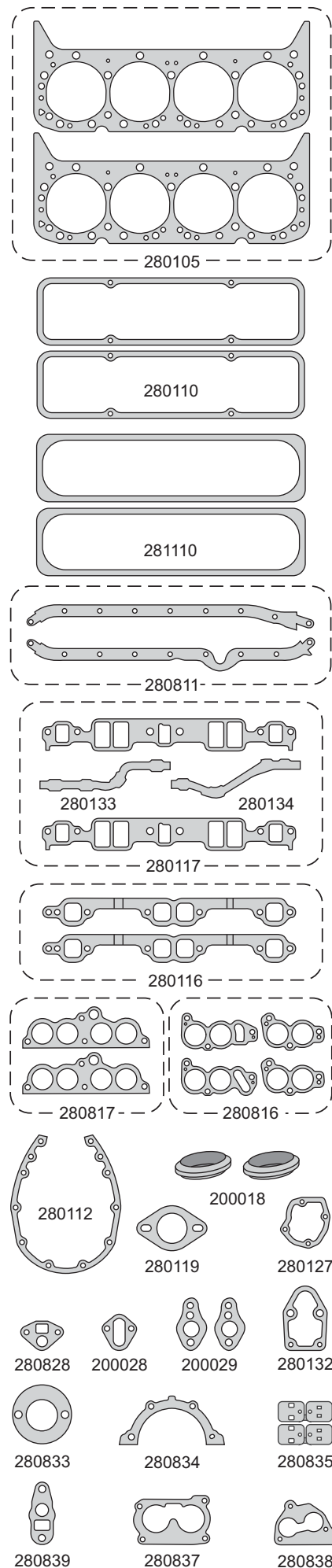

GM / CHEVROLET

CHEVROLET



Motor/Engine **Cm³** **HP** **Ø**
C350 V8 **5735** **101.6**

Chevrolet: Trucks 1996/01 - Vortec Vin R



GM / CHEVROLET

Nº OE	Descripción/Description	Mat.	Ref.
	Jgo. de juntas para motor		281100-RMX
	Jgo. de juntas superior	●	281195
	Jgo. junta tapa cilin. Ø 105 ± 1.20 (2)	NFT 2 2	280105
	Junta tapa de válvulas	GS 2 2	281110
	Junta para cárter	GS 1	280111
	Jgo. múltiple escape (3)	AC 2 2	281116-1
	Jgo. múltiple admisión (4)	VS 1 1	281117
	Acople bomba aceite	CB 2	200029
	Junta base distribuidor	NB 1	200329
	Guarnición unión admisión	CG 1	242730
	Guarnición unión admisión	CG 1	242731
	Junta porta retén	CB 1	280834
	Guarnición	GS 1 1	281136
	Guarnición	GS 1 1	281137
	Guarnición	GS 1 1	281138
	Guarnición	GS 1 1	281139
	O´ring G 18.72 x 2.62	GS 2	
	O´ring G 66.27 x 3.53	GS 1	
	O´ring G 85.32 x 3.53	GS 1	
	Kit de retenes completo		R281100
	Jgo. retén válvulas (16)	P 1	R281110P
	Retén bancada 95 x 115 x 12.5	S 1	R242111S
	Retén distribución 44.47 x 61.19 x 9.57	P 1	R200012P

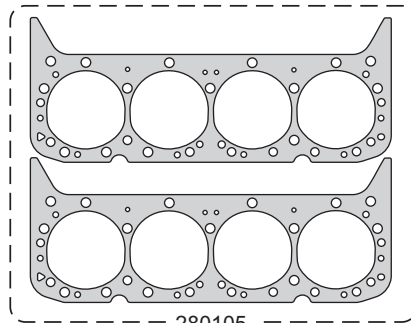

280105

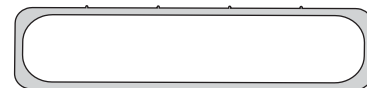

281110

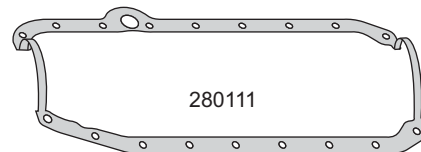

280111

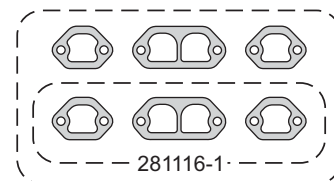

281116-1

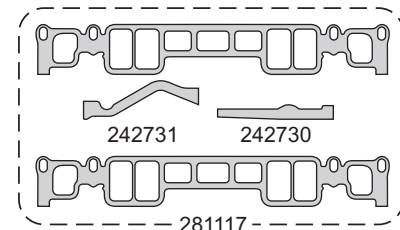

281117

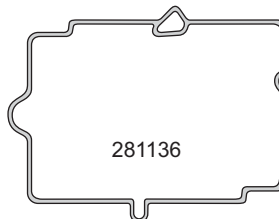

281136



200029



200329



280834



281137



281138



G 18.72 x 2.62



281139



G 66.27 x 3.53



G 85.32 x 3.53



R242111S



R200012P

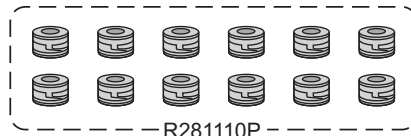

R281110P

CHEVROLET



Motor/Engine **L18 V8** Cm³ **8123** HP **550** Ø **108**

Chevrolet: Silverado/GMC Sierra 2500/3500HD
Suburban/GMC Yukon XL
Avalanche 2500
Kodiak 2001/04



Nº OE	Descripción/Description	Mat.	Ref.
	Jgo. de juntas para motor		281200-R
	Jgo. jta. tapa cilindro Ø 110 ± 1.70 (2)	NFT	1 281207
	Junta tapa válvulas	GS	2 281210
	Junta para cárter	GS	1 281211
	Tapa distribución	GS	1 281212
	Jgo. múltiple escape (2)	GFT	1 281216
	Jgo. múltiple admisión (4)	AC/GS	1 281217
	Bomba de agua	AC/GS	1 281230
	Tubo bomba de agua	GFT	1 281231
	Válvula EGR	GFT	1 290231
	Tubo válvula EGR	GFT	1 281232
	Tubo válvula EGR	GFT	1 281233
	Junta cuerpo aceleración	NH	1 281234
	Junta	N	1 290244
	O´ring G 7.52 x 3.53	GS	16
	Kit de retenes completo		R281200
	Jgo. retén válvulas (16)	P	1 R281210P
	Retén bancada	T	1 R281211T
	Retén distribución	T	1 R281212T

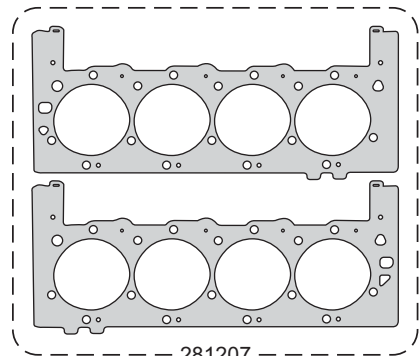

281207

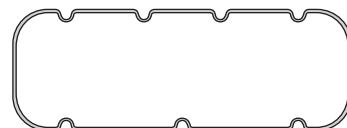

281210

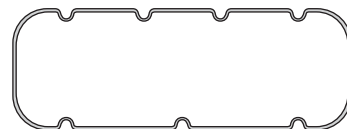

281211

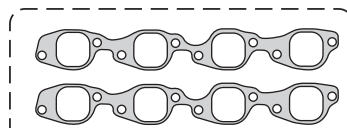

281216

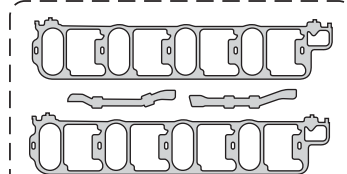

281217

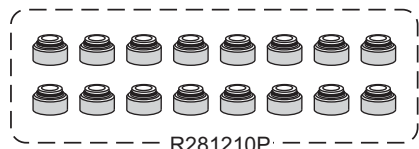
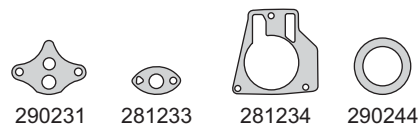
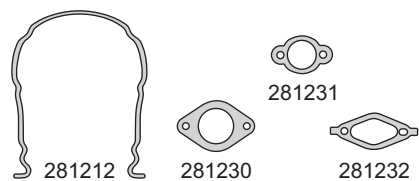

GM / CHEVROLET

CHEVROLET



Motor/Engine	Cm ³	HP	Ø
Atlas LL8 - L6 (DOHC) 24V	4160	275	94

Chevrolet: Trail Blazer 2002/06



GM / CHEVROLET

Nº OE	Descripción/Description	Mat.	Mat.	Mat.	Ref.
	Jgo. de juntas para motor				281300-R
	Jgo. de juntas superior		●		281395
	Junta tapa de cilin. Ø 94 ± 0.70	MLS	1	1	281308
	Conj. junta tapa válvulas (7)	GS	1	1	281310
	Múltiple escape	AC	1	1	281315
	Jgo. múltiple admisión (3)	GS	1	1	281317
	Bomba de agua	AC		1	281330
	Junta tubo de succión aceite	AC/GS		1	281331
	Junta salida caja termostato	GS		1	281333
	Junta salida anticongelante	GS		1	281334
	Junta	GS		1	281335
	Junta cuerpo de aceleración	GS	1	1	281336
	Junta válvula control de emisiones	GFT		1	281337
	O´ring termostato G 56.7 x 3.53	GS		1	
	Kit de retenes completo				R281300
	Jgo. retén válvulas (24)	V		1	R281310V
	Retén bancada 105 x 128 x 11/13.5	T		1	R281311T
	Retén distribución 44 x 59 x 8.5/10	T		1	R281312T

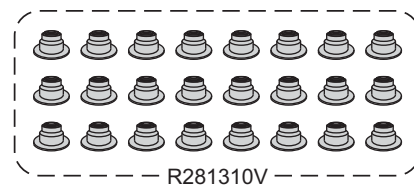
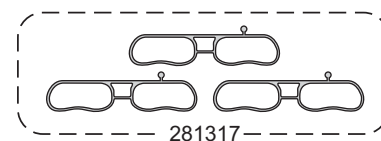
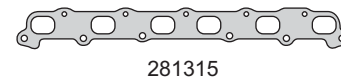
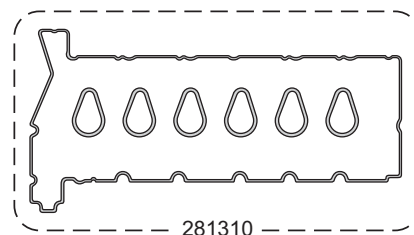
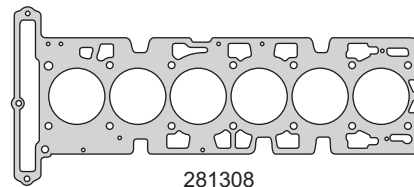

CHEVROLET



Motor/Engine	Cm³	HP	Ø
LY2	4800	295	96
L59	5300	295	96

Chevrolet: Vortec - Silverado - Sierra
Suburban - Tahoe Yukon 2001/03

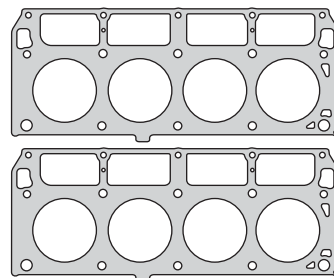

281408

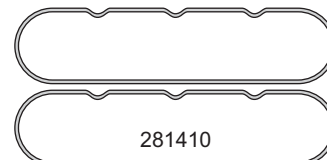

281410

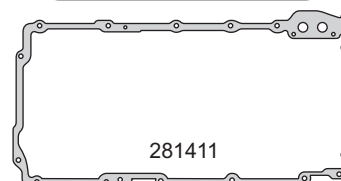

281411

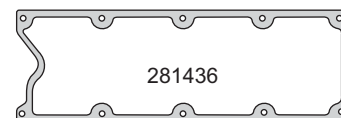

281436

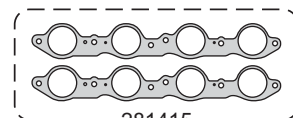

281415

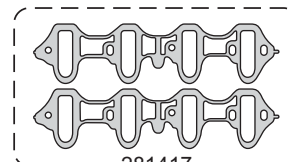

281417

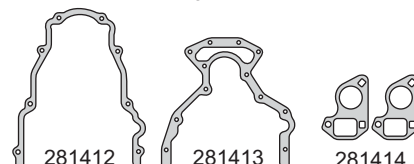

281412

281413

281414



281418

281430

281431

281432

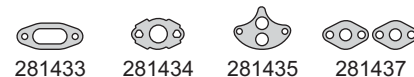

281433

281434

281435

281437



281438

G 7.52 x 3.53

G 9.19 x 2.62

290243

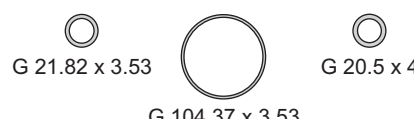

G 21.82 x 3.53

G 104.37 x 3.53

G 20.5 x 4

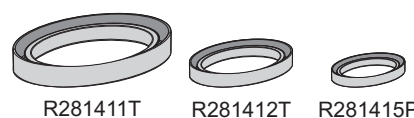

R281411T

R281412T

R281415P

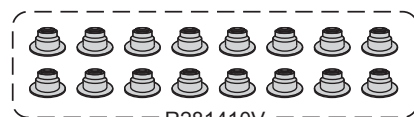

R281410V

Nº OE	Descripción/Description	Mat.	Ref.
	Jgo. de juntas para motor		● 281400-R
	Junta tapa cilindros Ø 97.4 ± 1.30	MLS	2 281408
	Junta tapa válvulas	GS	2 281410
	Junta para cárter	AL/GS	1 281411
	Junta distribución	AL/GS	1 281412
	Junta distribución	AL/GS	1 281413
	Bomba de agua	AC/GS	2 281414
	Jgo. múltiple escape (2)	AC	1 281415
	Jgo. múltiple admisión (2)	PLAST	1 281417
	Junta	GS	2 281418
	Junta	AC/GS	4 281430
	Junta	AC/GS	1 281431
	Junta	GS	1 281432
	Junta	AC/GS	1 281433
	Junta	GFT	1 281434
	Junta	NFT	1 281435
	Junta	AL/GS	1 281436
	Junta	NFT	2 281437
	Junta	NB	2 281438
	O´ring G 11 x 20.5 x 2.5	GS	1 290243
	O´ring G 21.82 x 3.53	GS	1
	O´ring G 104.37 x 3.53	GS	1
	O´ring G 9.19 x 2.62	GS	8
	O´ring G 20.5 x 4	GS	1
	O´ring G 7.52 x 3.53	GS	8
	Kit de retenes completo		R281400
	Jgo. retén válvulas (16)	V	1 R281410V
	Retén bancada 100 x 114.8 x 10	T	1 R281411T
	Retén distribución 55 x 72 x 8.5	T	1 R281412T
	Retén auxiliar 18 x 47.7 x 9	P	1 R281415P

CHEVROLET



Motor/Engine	Cm³	HP	Ø
LQ4	6000	325	101.6

Chevrolet: Vortec - Silverado - Sierra
Suburban - Tahoe Yukon - Express
Pick Up 2500/3500 2001/03

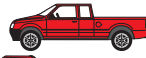

GM / CHEVROLET

Nº OE	Descripción/Description	Mat.	Ref.
	Jgo. de juntas para motor		281500-R
	Jgo. de juntas superior	●	281595
	Junta tapa cilin. Ø 102.7 ± 1.30	MLS 2 2	281508
	Junta tapa válvulas	GS 2 2	281410
	Junta para cárter	AL/GS 1	281411
	Junta distribución	AL/GS 1	281412
	Junta distribución	AL/GS 1	281413
	Bomba de agua	AC/GS 2	281414
	Jgo. múltiple escape (2)	AC 1 1	281415
	Jgo. múltiple admisión (2)	PLAST 1 1	281417
	Junta	GS 2 2	281418
	Junta	AC/GS 4 4	281430
	Junta	AC/GS 1 1	281431
	Junta	GS 1 1	281432
	Junta	AC/GS 1	281433
	Junta	GFT 1	281434
	Junta	NFT 1 1	281435
	Junta	AL/GS 1 1	281436
	Junta	NFT 2	281437
	Junta	NB 2	281438
	O´ring G 11 x 20.5 x 2.5	GS 1	290243
	O´ring G 21.82 x 3.53	GS 1	
	O´ring G 104.37 x 3.53	GS 1	
	O´ring G 9.19 x 2.62	GS 8 8	
	O´ring G 20.5 x 4	GS 1 1	
	O´ring G 7.52 x 3.53	GS 8	
	Kit de retenes completo		R281500
	Jgo. retén válvulas (16)	V 1	R281410V
	Retén bancada 100 x 114.8 x 10	T 1	R281411T
	Retén distribución 55 x 72 x 8.5	T 1	R281412T
	Retén auxiliar 18 x 47.7 x 9	P 1	R281415P

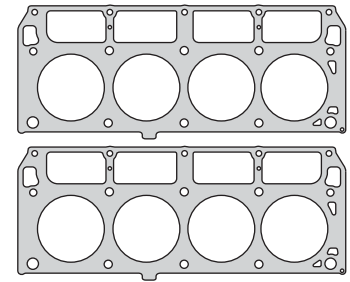

281508

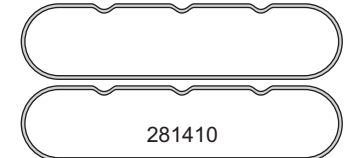

281410

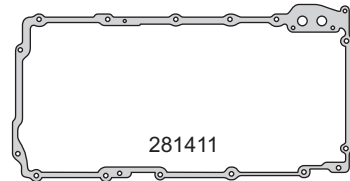

281411

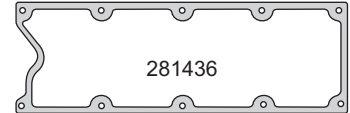

281414

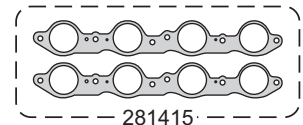

281415

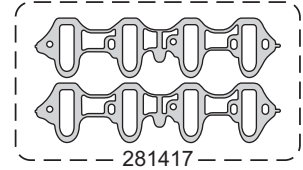

281417

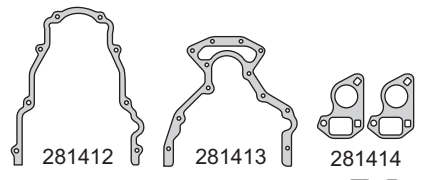

281412

281413

281414



281418

281430

281431

281432

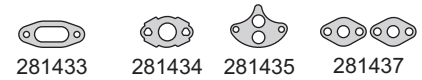

281433

281434

281435

281437

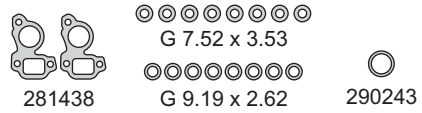

281438

G 7.52 x 3.53

G 9.19 x 2.62

290243



G 21.82 x 3.53

G 104.37 x 3.53

G 20.5 x 4

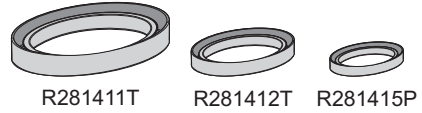

R281411T

R281412T

R281415P



R281410V

CHEVROLET



Motor/Engine	Cm³	HP	Ø
Z18XE	1796	120	80.5

Chevrolet: Astra 2000/03



Nº OE	Descripción/Description	Mat.	Ref.
	Jgo. de juntas para motor		281600-R
	Jgo. de juntas superior		281695
	Jta. tapa cilindros Ø 81.5 ± 0.50 N.R.	MLS 1 1	281608
	Jgo. tornillos tapa cilindros (HAE12038)		B280600
	Junta tapa válvulas	GS 1 1	281610
	Frente motor bomba de aceite	SLS 1 1	241812
	Múltiple escape	AC 1 1	281615
	Múltiple admisión	SLS 1 1	241817
	Kit de retenes completo		R281600
	Jgo. retén válvulas (16)	V 1	R281610V
	Retén bancada 80 x 98 x 10	P 1	R240411P
	Retén árbol de levas 35 x 48 x 7	P 2	R240013P
	Retén auxiliar 30 x 40 x 7	P 1	R550615P

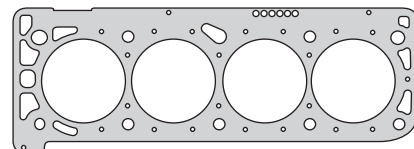

281608

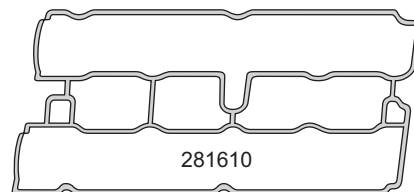

281610



281615



241817

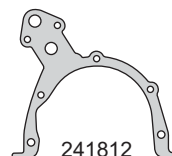

241812



R240411P

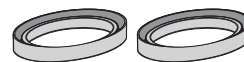

R240013P



R550615P

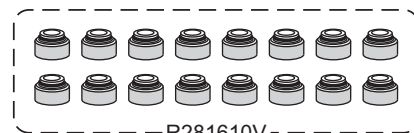

-R281610V-

GM / CHEVROLET

CHEVROLET



Motor/Engine	Cm³	HP	Ø
V6 LG8	3100	170	89

Chevrolet: Malibu 2000/03



GM / CHEVROLET

Nº OE	Descripción/Description	Mat.		Ref.
	Jgo. de juntas para motor		●	281700-R
	Jgo. de juntas superior		●	281795
	Jgo. jta. tapa cil. Ø 92 ± 1.62 (2)	NFT	1 1	281707
	Jgo. junta tapa válvulas (2)	GS	1 1	281710
	Junta para cárter	GS	1 1	281711
	Junta distribución	NB	1 1	241912
	Jgo. múltiple escape (2)	CHA	1 1	281715
	Jgo. múltiple admisión (2)	PLAST	1 1	281717
	Junta	NFT	1 1	281730
	Junta	CB	1 1	281731
	Junta chupador aceite	GFT	1 1	290231
	Jgo. entre múltiples (2)	NB	1 1	281732
	Guarnición goma	GS	7 7	281733
	Bomba de agua	CB	1 1	241934
	Junta base termostato	NB	1 1	241937
	O´ring G 11 x 20.5 x 2.5	GS	1 1	290243
	Guarnición goma	N	1 1	290244
	O´ring G 10.77 x 2.62	GS	1 1	
	O´ring G 9.19 x 2.62	GS	6 6	
	O´ring G 13.94 x 2.62	GS	2 2	
	O´ring G 6.07 x 1.78	GS	1 1	
	O´ring G 7.52 x 3.53	GS	12 12	
	O´ring G 17.12 x 2.62	GS	1 1	
	O´ring G 21.89 x 2.62	GS	1 1	
	O´ring G 18.77 x 1.78	GS	1 1	
	O´ring G 12.42 x 1.78	GS	1 1	
	O´ring G 21.95 x 1.78	GS	1 1	
	Kit de retenes completo			R281700
	Jgo. retén válvulas (12)	P	1 1	R281710P
	Retén bancada 76 x 92 x 10	P	1 1	R241911P
	Retén distribución 44.47 x 61.19 x 9.57	N	1 1	R200012N

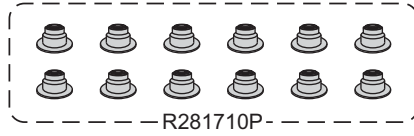
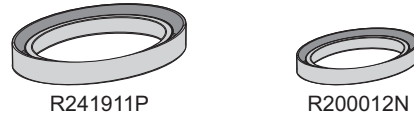
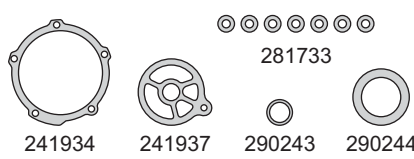
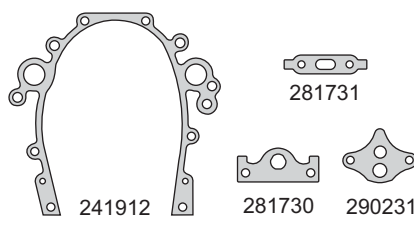
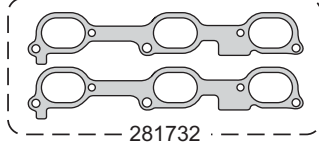
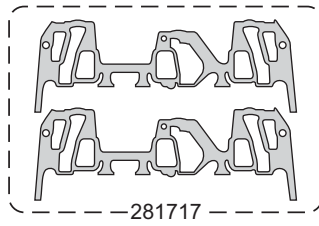
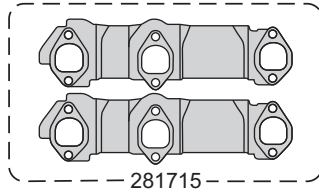
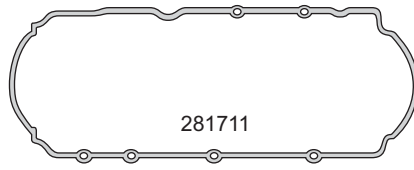
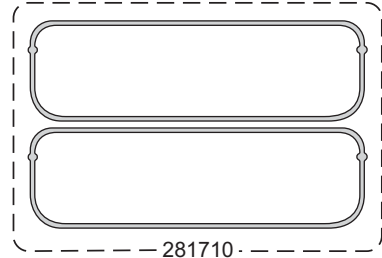
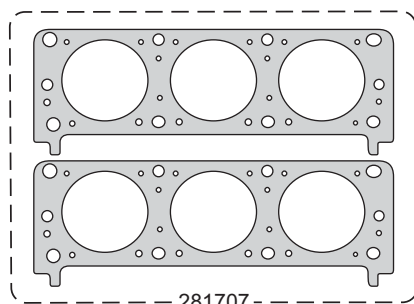

CHEVROLET



Motor/Engine	Cm³	HP	Ø
LN2	2190	120	89

Chevrolet: Cavalier 1998/03



Nº OE	Descripción/Description	Mat.	Ref.
	Jgo. de juntas para motor		281800-R
	Jgo. de juntas superior		281895
	Jta. tapa cilindros Ø 91.5 \pm 1.60	NFT 1 1	290307
	Junta tapa válvulas	GS 1 1	290410
	Jgo. junta para cárter (2)	CG 1	290211
	Múltiple escape	NFT 1 1	290416
	Múltiple admisión	NFT 1 1	290417
	Base termostato	GFT 1 1	290219
	Bomba aceite	CB 1	290227
	Tapa termostato	CB 1	290230
	Junta	NB 1	281830
	Chupador aceite	GFT 1	290231
	Junta	NFT 1	290431
	Junta	NB 1	290432
	Junta	CB 1	290433
	Cogotera	N 1	290238
	Lateral	N 1	290241
	Guarnición	CB 1	290344
	Arandela A 12.8 x 22.8 x 2 PL	PLAST 1	
	Arandela A 13 x 23 x 1.5 C	CU 1	
	O´ring G 24.99 x 3.53	GS 1	
	O´ring G 20 x 2	GS 4 4	
	O´ring G 14 x 2.5	GS 1	
	O´ring G 12.42 x 1.78	GS 4 4	
	O´ring G 8 x 1.50	GS 2	
	O´ring G 6.07 x 1.78	GS 2	
	Kit de retenes completo		R281800
	Jgo. retén válvulas (8)	V 1	R281810V
	Retén bancada 76 x 92 x 10	P 1	R241911P
	Retén distribución 44.47 x 61.19 x 9.57	P 1	R200012P

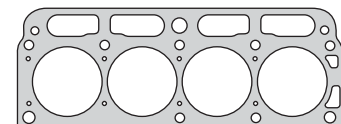

290307

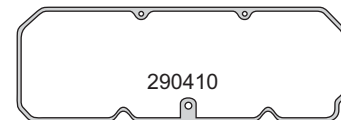

290410

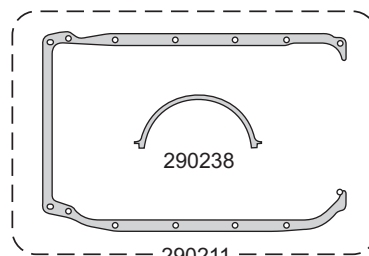

290211



290416



290417

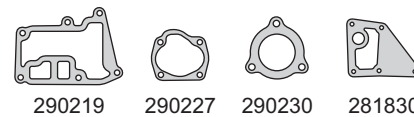

290219

290227

290230

281830

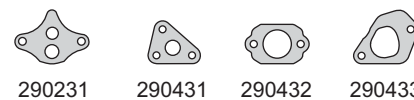

290231

290431

290432

290433

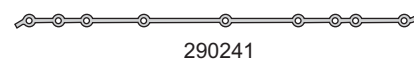

290241



G 8 x 1.5

290344

G 14 x 2.5



G 20 x 2



A 12.8 x 22.8 x 2

A 13 x 23 x 1.5 C

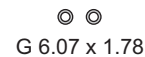

G 6.07 x 1.78

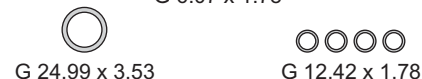

G 24.99 x 3.53

G 12.42 x 1.78



R241911P

R200012P



R281810V

GM / CHEVROLET

CHEVROLET



Motor/Engine	Cm ³	HP	Ø
X20XEV (DOHC) 16V	1998	128/136	86

Chevrolet: Astra 1995/98 - Zafira - Optra 1998/...



Nº OE	Descripción/Description	Mat.	Ref.
	Jgo. de juntas para motor		281900-R
	Jgo. de juntas superior	●	281995
56 07 449	Jta. tapa cilindros Ø 88 \pm 1.30	NFT	1 1 281907
607 647	Conj. junta tapa de válvulas (11)	N	1 1 280710
	Bomba aceite filtro a block	NB	1 240012
850 655	Múltiple escape	NFT	1 1 280715
850 656	Múltiple admisión	NB	1 1 280717
	Guarnición goma termostato	GS	1 1 280730
	Guarnición goma termostato	GS	1 1 280731
	Junta	NB	1 290833
	Junta	AC	1 1 290836
	Junta	AC	1 1 290837
	Arandela A 20 x 25 x 2 A	AL	1
	O´ring G 9 x 2	GS	10 10
	Kit de retenes completo		R281900
642 533	Jgo. retén válvulas (16)	V	1 R280610V
614 827	Retén bancada 90 x 104 x 11	P	1 R240211P
646 265	Retén distribución 31 x 50 x 8	P	1 R240012P
636 841	Retén árbol de levas 35 x 48 x 7	P	2 R240013P

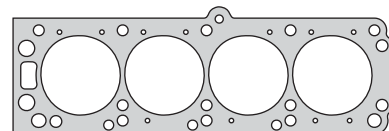

281907

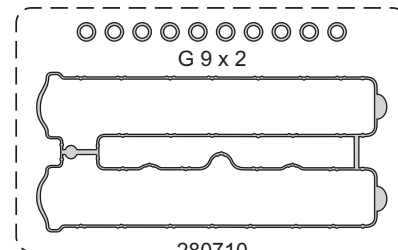

280710

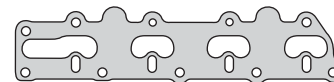

280715

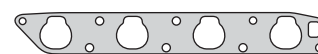

280717

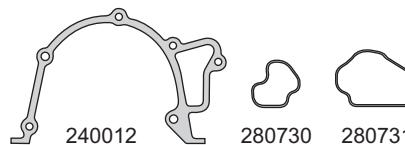

240012

280730

280731



290833



290836



290837



A 20 x 25 x 2 A



R240211P



R240013P



R240012P

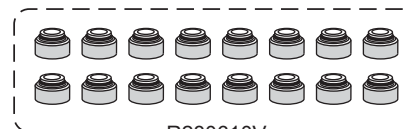

R280610V

GM / CHEVROLET

CHEVROLET



Motor/Engine	Cm³	HP	Ø
LA1 3400 V6	3350	170	92

Chevrolet: Venture - Impala - Monte Carlo
Alero - Gran Am - Aztek - Silhouette
Trans Port 2000/03



Nº OE	Descripción/Description	Mat.	Ref.
	Jgo. de juntas para motor		282000-R
	Junta tapa cilindros Ø 95 ±1.40 N.R.	GFT	2 282007
	Conj. junta tapa válvulas (2)	GS	1 281710
	Junta para cárter	GS	1 281711
	Junta distribución	NB	1 241912
	Jgo. múltiple escape (2)	CHA	1 281715
	Jgo. múltiple admisión (2)	PLAST	1 281717
	Junta	NFT	1 281730
	Junta chupador aceite	GFT	1 290231
	Jgo. entre múltiples (2)	NB	1 281732
	Bomba de agua	CB	1 241934
	Junta base termostato	NB	1 241937
	O´ring G 11 x 20.5 x 2.5	S	1 290243
	Guarnición	N	1 290244
	O´ring G 10.77 x 2.62	GS	1
	O´ring G 9.19 x 2.62	GS	6
	O´ring G 13.94 x 2.62	GS	2
	O´ring G 6.07 x 1.78	GS	1
	O´ring G 7.52 x 3.53	GS	12
	O´ring G 17.12 x 2.62	GS	1
	O´ring G 21.89 x 2.62	GS	1
	O´ring G 18.77 x 1.78	GS	1
	O´ring G 12.42 x 1.78	GS	1
	O´ring G 21.95 x 1.78	GS	1
	Kit de retenes completo		R281700
	Jgo. retén válvulas (12)	P	1 R281710P
	Retén bancada 76 x 92 x 10	P	1 R241911P
	Retén distribución 44.47 x 61.19 x 9.57	N	1 R200012N

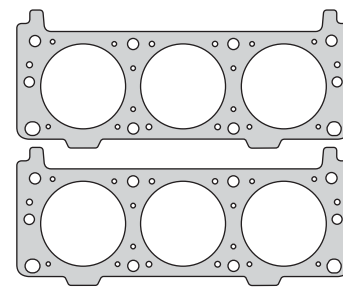

282007

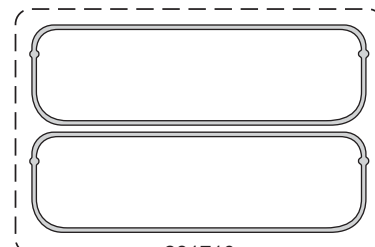

281710

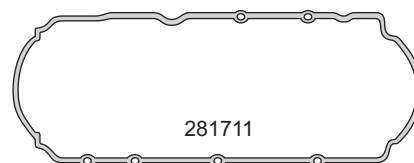

281711

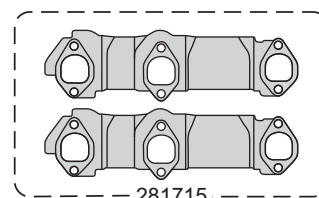

281715

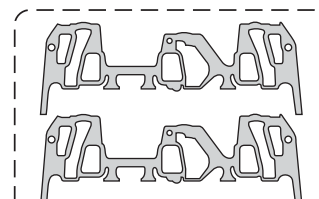

281717

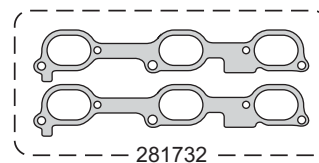

281732

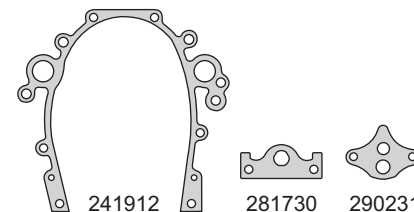

241912

281730

290231

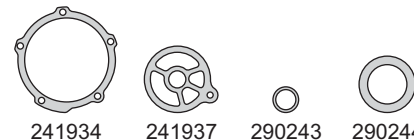

241934

241937

290243

290244



R241911P

R200012N

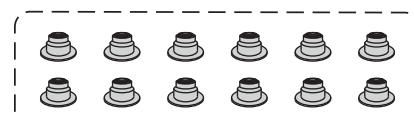

R281710P

CHEVROLET



Motor/Engine	Cm ³	HP	Ø
Z22SE L61 (DOHC) 16V	2198	147	86

Chevrolet: Cavalier - Malibu - HHR - Astra - Zafira
Vectra - Pontiac Sunfire - Grand Am
2000/03

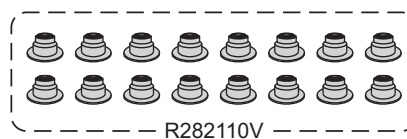
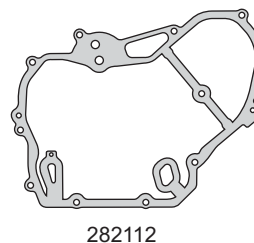
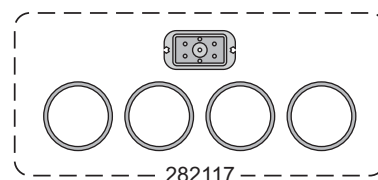
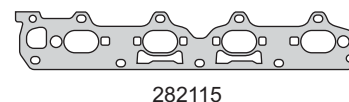
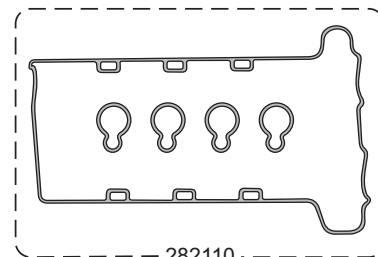
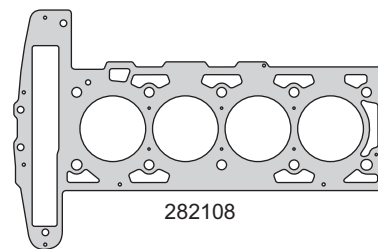

Nº OE	Descripción/Description	Mat.	Ref.
	Jgo. de juntas para motor		282100-R
	Junta tapa de cilindros Ø 87 ± 0.50	MLS 1	282108
	Conj. junta tapa válvulas (5)	GS 1	282110
	Junta distribución	GS/AC 1	282112
	Múltiple escape	GFT 1	282115
	Jgo. múltiple admisión (5)	VS 1	282117
	Junta	GS 1	282130
	Kit de retenes completo		R282100
	Jgo. retén válvulas (16)	P 1	R282110P
	Retén bancada 90 x 104 x 11	P 1	R240211P

GM / CHEVROLET

CHEVROLET



Motor/Engine **Cm³** **HP** **Ø**

LG8 **3136** **170** **89**

Chevrolet: Malibu 1997/99



Nº OE	Descripción/Description	Mat.	Ref.
	Jgo. de juntas para motor		282200-R
	Jgo. junta tapa cilin. Ø 92 ±1.62 (2) N.R.	NFT	1 281707
	Jgo. junta tapa válvulas (2)	GS	1 281710
	Junta para cárter	GS	1 281711
	Junta distribución	NB	1 241912
	Jgo. múltiple escape (2)	CHA	1 281715
	Jgo. múltiple admisión (2)	PLAST	1 282217
	Junta	NFT	1 281730
	Junta	CB	1 281731
	Junta chupador aceite	GFT	1 290231
	Jgo. entre múltiples (2)	NB	1 282232
	Guarnición	GS	7 281733
	Bomba de agua	CB	1 241934
	Junta base termostato	NB	1 241937
	O´ring G 11 x 20.5 x 2.5	S	1 290243
	Guarnición	N	1 290244
	O´ring G 10.77 x 2.62	GS	1
	O´ring G 9.19 x 2.62	GS	6
	O´ring G 13.94 x 2.62	GS	2
	O´ring G 6.07 x 1.78	GS	1
	O´ring G 7.52 x 3.53	GS	12
	O´ring G 17.12 x 2.62	GS	1
	O´ring G 21.89 x 2.62	GS	1
	O´ring G 18.77 x 1.78	GS	1
	O´ring G 12.42 x 1.78	GS	1
	O´ring G 21.95 x 1.78	GS	1
	O´ring G 28 x 5	GS	1
	Kit de retenes completo		R282600
	Jgo. retén válvulas (12)	V	1 R282210V
	Retén bancada 76 x 92 x 10	P	1 R241911P
	Retén distribución 44.47 x 61.19 x 9.57	N	1 R200012N

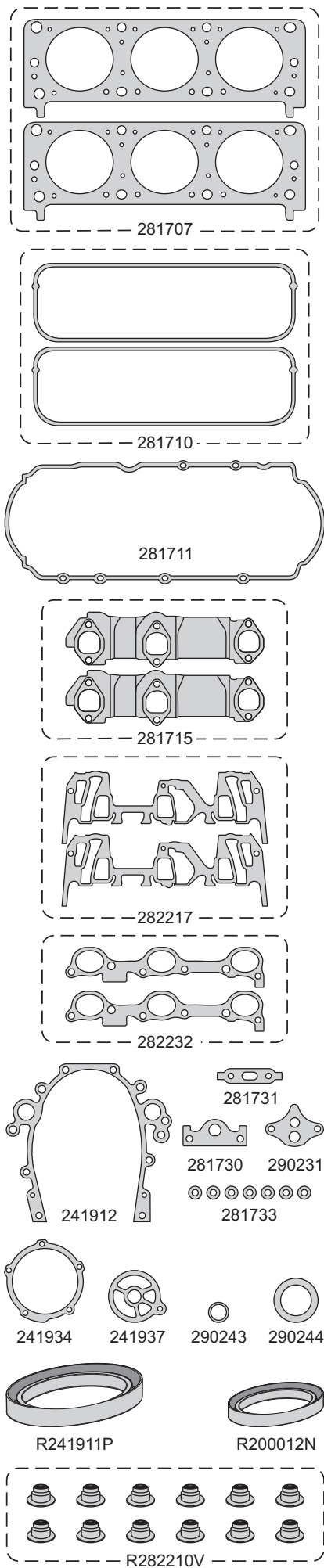

GM / CHEVROLET

CHEVROLET



Motor/Engine Cm³ HP Ø

ZX14E 1389 90 73.4

Chevrolet: Corsa 2002/04

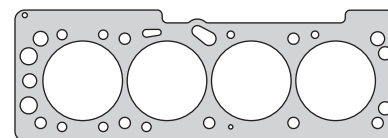

282307

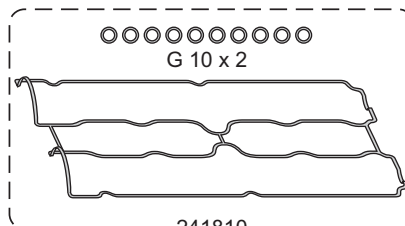

G 10 x 2

241810



282316

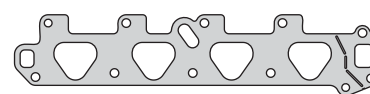

282317

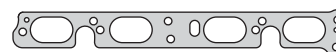

282332

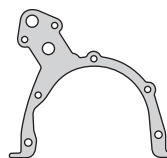

241812



282331



282330



G 60.05 x 1.78



G 80 x 3



G 15.54 x 2.62



A 14 x 18 x 1.25 A



A14 x 20 x 1.5 A



R240411P



R240013P



R240415V



R280610V

Nº OE	Descripción/Description	Mat.	Ref.
	Jgo. de juntas para motor		282300-R
	Junta tapa cilindros Ø 79 ±1.70	GFT 1	282307
	Conj. junta tapa válvulas (11)	GS 1	241810
	Junta distribución	SLS 1	241812
	Múltiple escape	GFT 1	282316
	Múltiple admisión	NB 1	282317
	Junta	NB 1	282330
	Junta	NB 1	282331
	Múltiple pleno de admisión	NB 1	282332
	O´ring G 10 x 2	GS 10	
	O´ring G 15.54 x 2.62	GS 1	
	O´ring G 80 x 3	GS 1	
	O´ring G 60.05 x 1.78	GS 1	
	Arandela A 14 x 18 x 1.25 A	AL 1	
	Arandela A14 x 20 x 1.5 A	AL 1	
	Kit de retenes completo		R282300
	Jgo. retén válvulas (16)	V 1	R280610V
	Retén bancada 85 x 105 x 12	P 1	R240411P
	Retén arbol levas 35 x 48 x 7	P 2	R240013P
	Retén distribución 26 x 42 x 8	V 1	R240415V

GM / CHEVROLET

CHEVROLET



Motor/Engine	Cm³	HP	Ø
LD9	2392	141/152	90

Chevrolet: Pontiac Sunfire - Grand Am - Malibu
Cavalier Z24 1996/04
Alero 1999/...

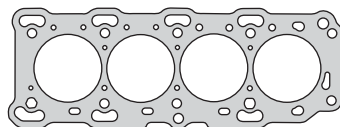

282407

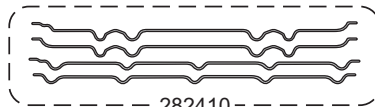

282410

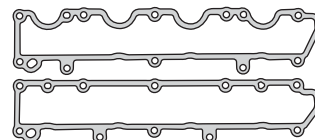

282436

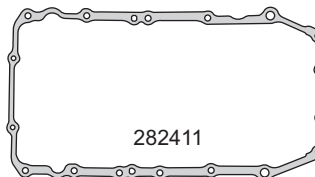

282411

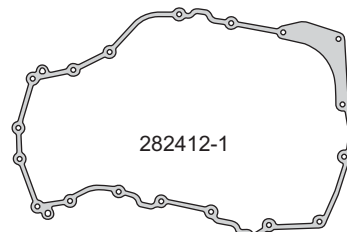

282412-1

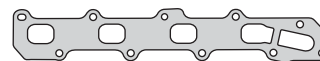

282415



282417

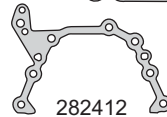

282412

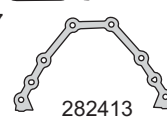

282413



282414



282414-1

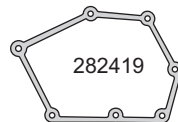

282419



282427



282430



230243



282444

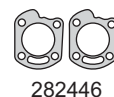

282446



G 59.69 x 3.53



282445



G 17.17 x 1.78



G 15.54 x 2.62

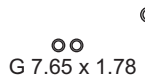

G 7.65 x 1.78

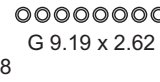

G 9.19 x 2.62



G 4.42 x 2.62



G 41 x 1.78

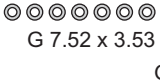

G 7.52 x 3.53



G 28.17 x 3.53



R282411V



R282412P

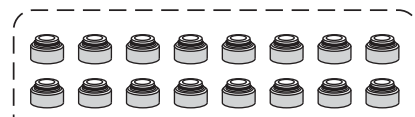

R282410V

Nº OE	Descripción/Description	Mat.	Ref.
	Jgo. de juntas para motor		282400-R
	Junta tapa cilindros Ø 91 ± 1.30	NFT	1 282407
	Conj. junta tapa válvulas (4)	GS	1 282410
	Junta para cárter	AL/GS	1 282411
	Junta distribución	NH	1 282412
	Junta distribución	AL/GS	1 282412-1
	Junta tapa distribución	NB	1 282413
	Bomba de agua	NB	1 282414
	Bomba de agua	NB	1 282414-1
	Múltiple escape	AC	1 282415
	Múltiple admisión	PLAST	1 282417
	Junta placa de agua	AL/GS	1 282419
	Junta bomba aceite a block	GFT	1 282427
	Junta brida	AL/GS	1 282430
	Junta tapa de válvulas		2 282436
	Guarnición goma	GS	1 230243
	Junta	NH	1 282444
	Junta	SLS	2 282446
	Junta	NB	1 282445
	O´ring G 59.69 x 3.53	GS	1
	O´ring G 41 x 1.78	GS	1
	O´ring G 28.17 x 3.53	GS	1
	O´ring G 17.17 x 1.78	GS	1
	O´ring G 15.54 x 2.62	GS	2
	O´ring G 9.19 x 2.62	GS	8
	O´ring G 7.65 x 1.78	GS	2
	O´ring G 7.52 x 3.53	GS	8
	O´ring G 4.42 x 2.62	GS	1
	Kit de retenes completo		R282400
	Jgo. retén válvulas (16)	V	1 R282410V
	Retén bancada 82 x 96 x 8	V	1 R282411V
	Retén distribución 51 x 73.2 x 9.5	P	1 R282412P

GM / CHEVROLET

CHEVROLET



Motor/Engine	Cm³	HP	Ø
B10S	995	63	68.5
F12S3	1148	71/72	68.5

Chevrolet: Spark 2003/06 - Aveo 2006/...
Daewoo: Matiz 2003/06 - Kalos 2002/...



GM / CHEVROLET

Nº OE	Descripción/Description	Mat.	Ref.
93740055	Jgo. de juntas para motor		282500-R
	Jgo. de juntas superior	●	282595
	Jta. tapa cilindros Ø 70 \pm 1.40	NFT 1 1	282507
	Junta tapa válvulas	GS 1 1	282510
	Junta distribución	NB 1 1	940012
	Bomba de agua	NB 1 1	940014
	Múltiple escape	NFT 1 1	282515
	Múltiple admisión	GS 1 1	282517
	Bomba aceite	NB 1 1	940027
	Mariposa aceleración	GS 1 1	282532
	Tapa inyección	NB 1 1	940039
	Porta retén inyección	NB 1 1	940041
	Kit de retenes completo		R282500
	Jgo. retén válvulas (8)	P 1	R282510P
	Retén bancada 60 x 80 x 8	S 1	R940011S
	Retén árbol levas y distrib. 32 x 47 x 10	P 2	R230113P

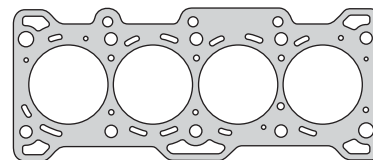

282507

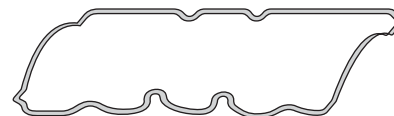

282510

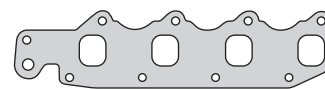

282515



282517



940012



940014



940027



282532



940039

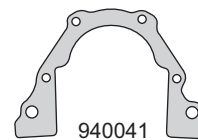

940041



R940011S



R230113P

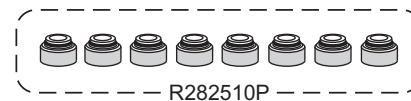

R282510P

CHEVROLET



Motor/Engine	Cm³	HP	Ø
LA1	3350	185	92

Chevrolet: Venture 1997/99



Nº OE	Descripción/Description	Mat.	Ref.
	Jgo. de juntas para motor		● 282600-R
	Jgo. junta tapa cilin. Ø 95 \pm 1.40 (2) N.R.	GFT	1 282007
	Jgo. junta tapa válvulas (2)	GS	1 281710
	Junta para cárter	GS	1 281711
	Junta distribución	NB	1 241912
	Jgo. múltiple escape (2)	CHA	1 281715
	Jgo. múltiple admisión (2)	PLAST	1 281717
	Junta	NFT	1 281730
	Junta chupador aceite	GFT	1 290231
	Jgo. entre múltiples (2)	NB	1 281732
	Bomba de agua	CB	1 241934
	Junta base termostato	NB	1 241937
	O´ring G 11 x 20.5 x 2.5	GS	1 290243
	Guarnición	N	1 290244
	O´ring G 10.77 x 2.62	GS	1
	O´ring G 9.19 x 2.62	GS	6
	O´ring G 13.94 x 2.62	GS	2
	O´ring G 6.07 x 1.78	GS	1
	O´ring G 7.52 x 3.53	GS	12
	O´ring G 17.12 x 2.62	GS	1
	O´ring G 21.89 x 2.62	GS	1
	O´ring G 18.77 x 1.78	GS	1
	O´ring G 12.42 x 1.78	GS	1
	O´ring G 21.95 x 1.78	GS	1
	Kit de retenes completo		R282600
	Jgo. retén válvulas (12)	V	1 R282210V
	Retén bancada 76 x 92 x 10	P	1 R241911P
	Retén distribución 44.47 x 61.19 x 9.57	N	1 R200012N

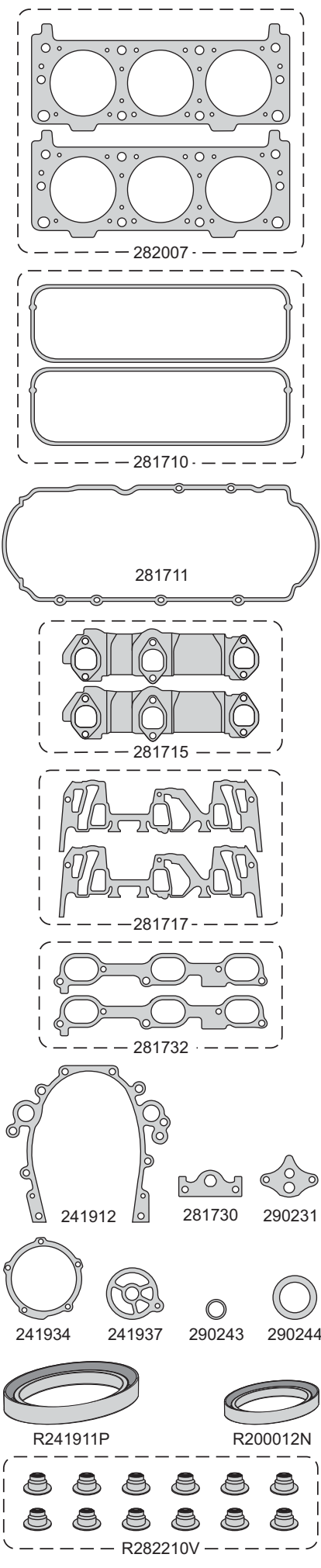

GM / CHEVROLET

CHEVROLET



Motor/Engine Cm³ HP Ø

LE5 16V 2384 174 88

Chevrolet: Captiva 2008/...

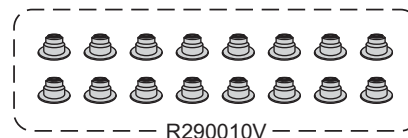
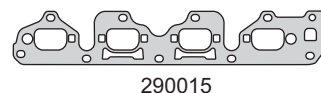
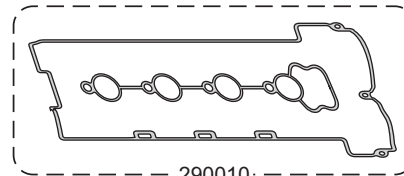
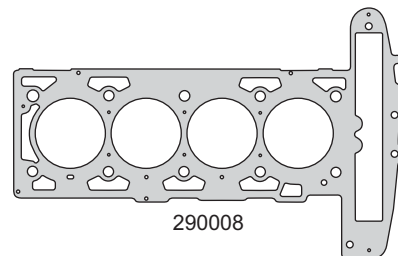

N° OE	Descripción/Description	Mat.	Ref.
	Jgo. de juntas para motor	●	290000-R MLS
	Junta tapa cilindros Ø 89 ± 0.70	MLS	1 290008
	Sellador líquido - caucho de silicona		TRN0280R
	Conj. junta tapa válvulas (2)	GS	1 290010
	Bomba de agua	GS	1 290014
	Múltiple escape	AC	1 290015
	Jgo. múltiple admisión (4)	GS	1 290017
	Junta termostato	GS	1 290019
	Kit de retenes completo		R290000
	Jgo. retén válvulas (16)	V	1 R290010V
	Retén bancada 90 x 104 x 11	V	1 R240211V
	Retén distribución 42 x 55 x 7	V	1 R290013V

GM / CHEVROLET

CHEVROLET



Motor/Engine	Cm³	HP	Ø
F14 D5	1399	94	77.9
F16 D3 (DOHC) 16V	1598	103/109	79

Chevrolet: Nubira 2003/05 - Aveo MPI 2004/...
Daewoo: Kalos - Lacetti 2004/...
 Nubira 2003/05



Nº OE	Descripción/Description	Mat.	Ref.
93742687	Jgo. de juntas para motor		290100-R
	Jgo. de juntas superior (MLS)		290195 MLS
	Junta tapa cilindros Ø 80.5 ± 1.20	NFT	1 290107
96963220	Junta tapa cilindros Ø 80 ± 0.60	MLS	1 290108
	Jgo. de tornillos para tapa de cilindros		B290100
96353002	Junta tapa válvulas	GS	1 290110
	Junta para cárter	CG	1 240411
96414580	Frente motor bomba aceite	SLS	1 241812
	O´ring bomba de agua G 80 x 3	N	1 240414
96378805	Múltiple escape	AC	1 290115
96461130	Jgo. múltiple admisión (4)	GS	1 290117
96376371	Guarnición comando aceleración	GS	1 290130
	Guarnición anillo especial G 27.5 x 38.5 x 6	GS	1 290131
	O´ring G 15.54 x 2.62	GS	1
	O´ring G 40.87 x 3.53	GS	1
	Arandela A 20 x 24 x 1.5 A	AL	1
	Arandela A 14 x 20 x 1.5 C	CU	1
	Kit de retenes completo		R290100
	Jgo. retén válvulas (16)	V	1 R570910V
96376569	Retén bancada 80 x 98 x 10	P	1 R240411P
96350161	Reten distribución 30 x 42 x 7	P	1 R260113P
94580413	Retén árbol de levas 42 x 56 x 7	P	2 R300612P

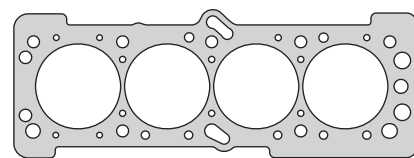

290107

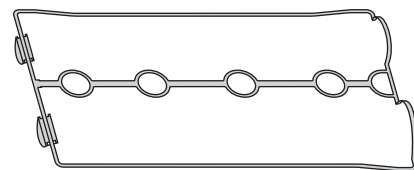

290110

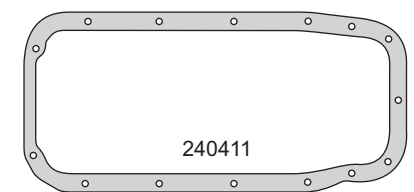

240411

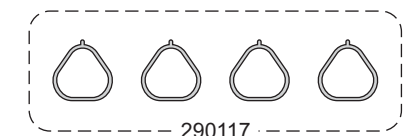

290117

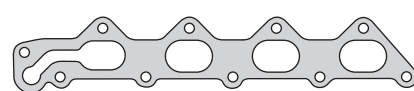

290115

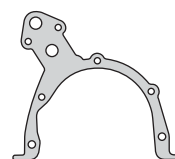

241812

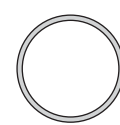

240414



290130



G 40.87 x 3.53



290131

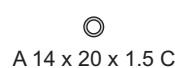

A 14 x 20 x 1.5 C

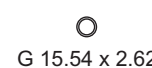

G 15.54 x 2.62



A 20 x 24 x 1.5 A



R240411P



R300612P



R260113P

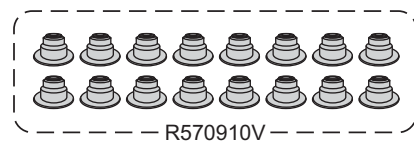

R570910V

GM / CHEVROLET

CHEVROLET



Motor/Engine	Cm ³	HP	Ø
LN2	2190	120	89

Chevrolet: Lumina - Cavalier 1987/97

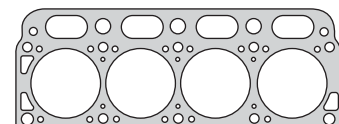

290207

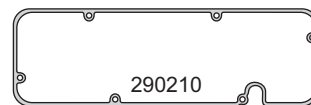

290210

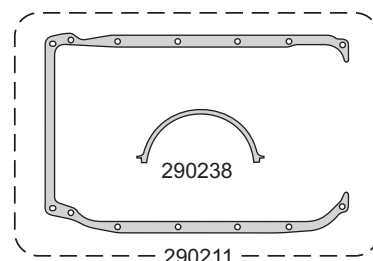

290211

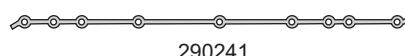

290241



290236



290215



290216



290217

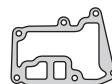

290219



290227



290230



290231



290232

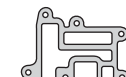

290233



290234



290235



290237



290239



290240



290242



290243



290244



290344



G 24.99 x 3.53



G 21.95 x 1.78



G 14 x 2.5



G 9.19 x 2.62



G 12.42 x 1.78



G 20 x 2



G 15.6 x 1.78



R200012N

Nº OE	Descripción/Description	Mat.	Ref.
	Jgo. de juntas para motor		290200-R
	Jgo. de juntas superior	●	290295
	Jta. tapa cilindros Ø 91.5 ± 1.60	NFT 1 1	290207
	Junta tapa válvulas	GS 1 1	290210
	Jgo. junta para cárter (2)	CG 1 1	290211
	Múltiple escape	NFT 1 1	290215
	Múltiple admisión	NFT 1 1	290216
	Múltiple admisión	NFT 1 1	290217
	Base termostato	GFT 1 1	290219
	Bomba aceite	CB 1 1	290227
	Tapa termostato	CB 1 1	290230
	Chupador aceite	GFT 1 1	290231
	Base filtro aceite	CB 1 1	290232
	Distribución aceite	GFT 1 1	290233
	Entrada agua	NFT 1 1	290234
	Salida agua	CB 1 1	290235
	Lateral de válvulas	CB 1 1	290236
	Retorno aceite	CB 1 1	290237
	Cogotera	N 1 1	290238
	Guarnición	N 1 1	290239
	Guarnición	N 1 1	290240
	Lateral	N 1 1	290241
	Varilla aceite	GFT 1 1	290242
	O´ring G 11 x 20.5 x 2.5	GS 1 1	290243
	Guarnición	N 1 1	290244
	Junta	N 1 1	290344
	O´ring G 9.19 x 2.62	GS 5 5	
	O´ring G 14 x 2.5	GS 2 2	
	O´ring G 12.42 x 1.78	GS 4 4	
	O´ring G 20 x 2	GS 4 4	
	O´ring G 15.6 x 1.78	GS 4 4	
	O´ring G 24.99 x 3.53	GS 2 2	
	O´ring G 21.95 x 1.78	GS 1 1	
	Arandela A 13 x 23 x 1.5 C	CU 1 1	
	Retén distribución 44.47 x 61.19 x 9.57	N 1 1	R200012N

GM / CHEVROLET

CHEVROLET



Motor/Engine	Cm³	HP	Ø
LM3	2190	120	89

Chevrolet: Lumina - Cavalier 1994/97



Nº OE	Descripción/Description	Mat.	Ref.
	Jgo. de juntas para motor		290300-R
	Junta tapa cilindros Ø 91.5 ± 1.60	NFT	1 290307
	Junta tapa válvulas	GS	1 290210
	Jgo. junta para cárter (2)	CG	1 290211
	Múltiple escape	NFT	1 290215
	Múltiple escape	NFT	1 290216
	Base termostáto	GFT	1 290219
	Bomba aceite	CB	1 290227
	Tapa termostato	CB	2 290230
	Chupador aceite	GFT	1 290231
	Base filtro aceite	CB	1 290232
	Distribución aceite	GFT	1 290233
	Lateral de válvulas	CB	1 290236
	Retorno aceite	CB	1 290237
	Cogotera	N	1 290238
	Guarnición	N	1 290239
	Guarnición	N	1 290240
	Lateral	N	1 290241
	Varilla aceite	GFT	1 290242
	Junta	CB	1 290342
	O´ring G 11 x 20.5 x 2.5	GS	1 290243
	Junta	CB	2 290343
	Junta	CB	2 290344
	Arandela A 13 x 23 x 1.5 C	CU	1
	O´ring G 6.07 x 1.78	GS	2
	O´ring G 8 x 1.5	GS	2
	O´ring G 12.42 x 1.78	GS	4
	O´ring G 14 x 2.5	GS	1
	O´ring G 20 x 2	GS	4
	O´ring G 24.99 x 3.53	GS	1
	Kit de retene completo		R290200
	Jgo. retén válvulas (8)	P	1 R290210P
	Retén bancada 76 x 92 x 10	P	1 R241911P
	Retén distribución 44.47 x 61.19 x 9.57	P	1 R200012P

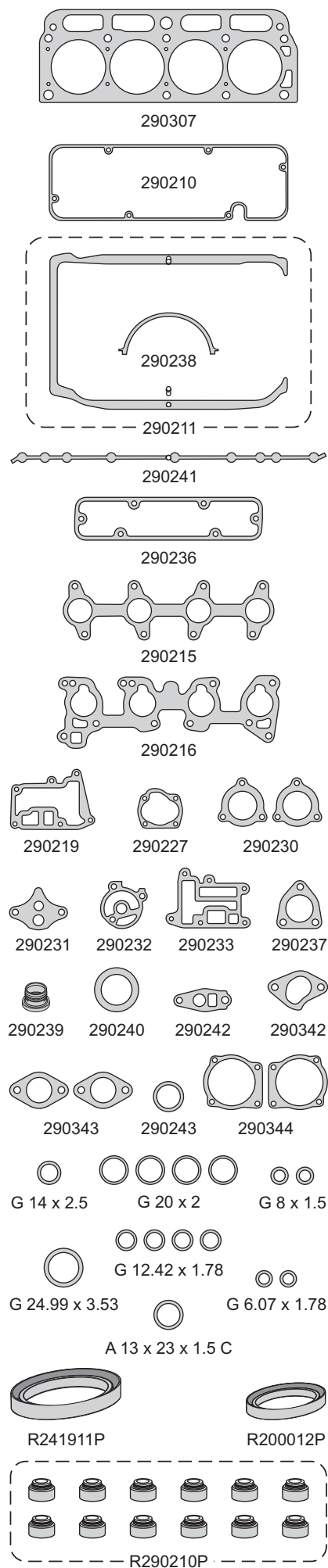

GM / CHEVROLET

CHEVROLET



Motor/Engine **Cm³** **HP** **Ø**

262 V6 **4294** **180/193** **101.6**

Chevrolet: Capriche - Impala - Regal
Blazer MPFI 1996/98



GM / CHEVROLET

Nº OE	Descripción/Description	Mat.	Ref.
	Jgo. de juntas para motor		290600-R
	Jgo. junta tapa cilin. Ø 105 ±1.20 (2)	NFT	1 290607
	Junta tapa válvulas	GS	2 290610
	Jgo. junta para cárter	GS	1 290611
	Jgo. múltiple escape (4)	AC	1 290615
	Jgo. múltiple admisión (2)	PLAST	1 290617
	Acople bomba de aceite	CB	2 200029
	Válvula E.R.G.	GFT	2 290231
	Válvula E.R.G.	NB	1 242139
	Junta frente	NB	290635
	Entrada de aire	GS	290636
	Tubo unión	GS	290637
	Junta llenado 33 x 46	CB	1 280143
	Junta	CB	1 280144
	O´ring G 15.54 x 2.62	GS	1
	O´ring G 13 x 20 x 2 A	GS	1
	O´ring G 10.82 x 1.78	GS	1
	Kit de retenes completo		R290600
	Jgo. retén válvulas (12)	P	1 R290610P
	Retén bancada 91.5 x 114.8 x 12.5	S	1 R290611S
	Retén distribución 44.47 x 61.19 x 9.57	P	1 R200012P

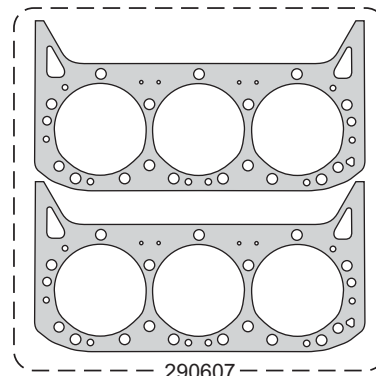

290607



290610

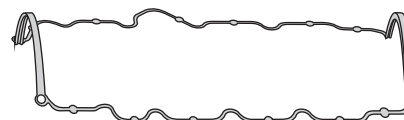
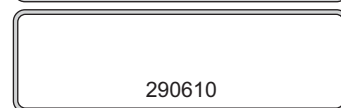

290611

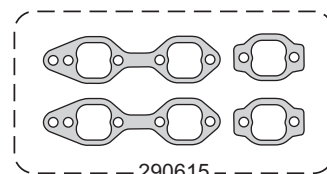

290615

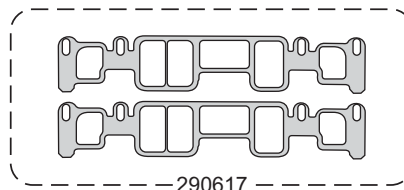

290617



200029

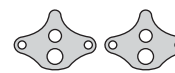

290231



242139

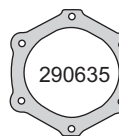

290635



290636



290637



280143



G 10.82 x 1.78

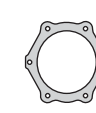

280144



G 15.54 x 2.62



G 13 x 20 x 2 A



R290611S



R200012P

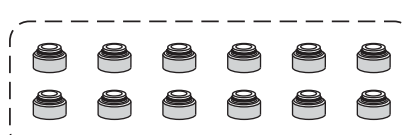

R290610P

CHEVROLET



Motor/Engine	Cm³	HP	Ø
X20 DTL	1995	82	84
X20 DTH	1995	100	84
X22 DTH	2171	115/116	84

Chevrolet: Astra - Vectra - Omega - Zafira - Opel
Omega - Frontera - Sintra

DIESEL



Nº OE	Descripción/Description	Mat.	Ref.
	Jgo. de juntas para motor		290701-R
	Junta tapa cilindros Ø 86 \pm 1.20	NFT	290707-SM
	Junta tapa cilindros Ø 86 \pm 1.30	NFT	290707-1M
	Junta tapa cilindros Ø 86 \pm 1.40	NFT	290707-2M
5607422	Junta tapa cilindros Ø 86 \pm 1.20	MLS	290708-SM
5607423	Junta tapa cilindros Ø 86 \pm 1.30	MLS	290708-1M
5607421	Junta tapa cilindros Ø 86 \pm 1.40	MLS	290708-2M
90.502.072	Jgo. tornillos tapa cilindros (HAE18038)		B290700
90.571.911	Junta tapa válvulas	ACP	1 290710
90.502.195	Junta para cárter	NFT	1 290711
90.500.931	Múltiple escape	AC	1 290715
90.572.108	Múltiple admisión	SLS	1 290717
	Junta	NFT	1 290729
90.500.940	Múltiple entre colectores admisión	SLS	1 290731
	O'ring tapón cárter G 17.12 x 2.62	GS	1
	O'ring G 45 x 4	GS	5
	Kit de retenes completo		R290700
642.533	Jgo. retén válvulas (16)	V	1 R280610V
90.570.322	Retén bancada 99 x 114 x 11	V	1 R290711V
90.500.805	Retén distribución 55 x 68 x 8	V	1 R270612V
	Retén distribución 42 x 60 x 10 1997/98	P	1 R450412P

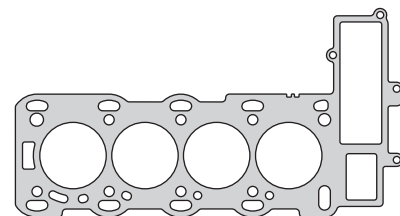

290707

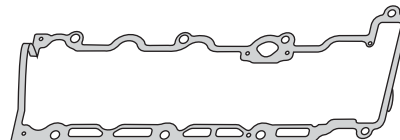

290710

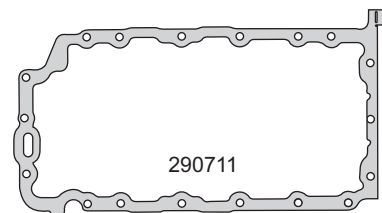

290711



290715



290717

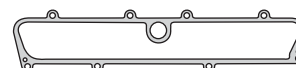

290731



290729



G 17.12 x 2.62



G 45 x 4



R290711V



R270612V



R450412P

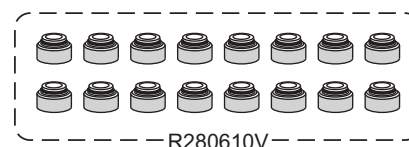

R280610V

GM / CHEVROLET

CHEVROLET



Motor/Engine	Cm³	HP	Ø
X20 XEV	1998	128/136	86
X22 XE (DOHC) 16V	2198	139/141	86

Chevrolet: Vectra - Astra - Calibra - Zafira 1994/...
Astra - Vectra 1998/...
Sintra 1996/99



GM / CHEVROLET

Nº OE	Descripción/Description	Mat.	Ref.
	Jgo. de juntas para motor		290800-R
	Jgo. de juntas superior	●	290895
	Jta. tapa cilindros Ø 88 ±1.40	NFT	280705
56 07 409	Jta. tapa cilindros Ø 88 ±1.40	NFT	1 1 280707
	Jgo. de tornillos JTC (HAT55055/HAT55100)		B280700
607 647	Conj. junta tapa de válvulas (11)	N	1 1 280710
652 635	Junta para cárter superior	NFT	1 290811
	Bomba aceite filtro a block	NB	1 240012
90220436	O´ring bomba de agua G 88.57 x 2.62	GS	1 280614
850 656	Múltiple escape	NFT	1 1 280715
850 655	Múltiple admisión	NB	1 1 280717
854 933	Salida de escape	FCH	1 1 240018
	Placa admisión	NFT	1 1 280729
	Guarnición goma termostato G 44.17 x 1.78	GS	1 1 280730
	Guarnición goma termostato G 66.4 x 1.78	GS	1 1 280731
652 636	Junta para cárter inferior	CG	1 290832
	Nivel aceite	SLS	1 280733
	Junta	NB	1 290833
	Junta	NB	1 290834
	Junta	CG	1 290835
	Arandela A 14 x 20 x 1C	CU	1
	Arandela A 20 x 24 x 1.5 A	AL	1
	O´ring G 9 x 2	GS	10 10
	O´ring G 15.54 x 2.62	GS	1
	O´ring G 16 x 2	GS	1
	O´ring G 47.22 x 3.53	GS	2
	O´ring G 50 x 4	GS	1
	O´ring G 52.07 x 2.62	GS	1
	O´ring G 53.7 x 1.78	GS	1
	O´ring G 64.77 x 2.62	GS	3
	Kit de retenes completo		R280700
642 533	Jgo. retén válvulas (16)	V	1 R280610V
614 827	Retén bancada 90 x 104 x 11	V	1 R240211V
646 265	Retén distribución 31 x 50 x 8	V	1 R240012V
636 841	Retén árbol de levas 35 x 48 x 7	V	2 R240013V

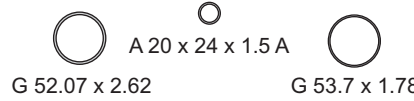
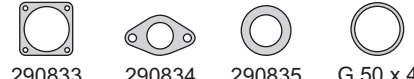
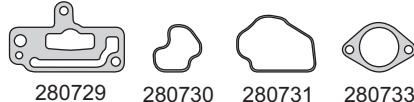
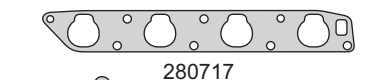
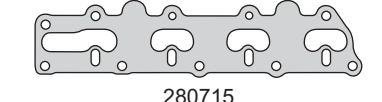
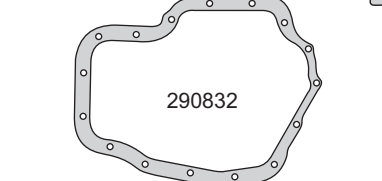
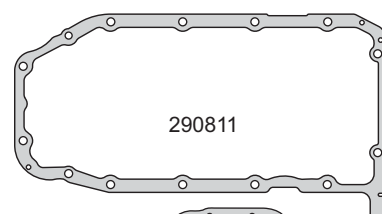
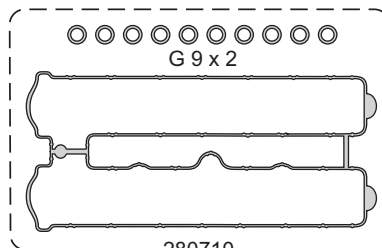
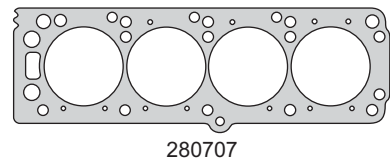

CHEVROLET



Motor/Engine	Cm³	HP	Ø
C20XE	1998	136/150	86
C20LET	1998	204	86

Chevrolet: Vectra 1994/96 - Calibra 1989/97
 Kadett E 1987/91 - Calibra Turbo 1992/97 - Vectra Turbo 1993/95
Lada: 110 GTI 1996/...



Nº OE	Descripción/Description	Mat.	Ref.
	Jgo. de juntas superior		290995
	Junta tapa cilindros Ø 88 ± 1.30	NFT	1 290907
	Jgo. tornillos tapa cilindros (HAE14038)		B290900
	Junta tapa de válvulas	GS	1 290910
	Múltiple escape	NFT	1 290916
	Múltiple admisión	NH	1 290917
	Arandela A 12 x 17 x 1.5 C	CU	1
	O'ring G 50.52 x 1.78	GS	1
	O'ring G 55.25 x 2.62	GS	1
	Jgo. retén válvulas (8)	V	R240210V
	Retén árbol de levas 35 x 48 x 7	V	R240013V

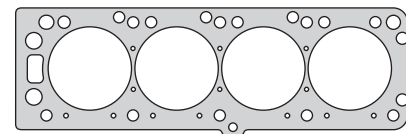

290908

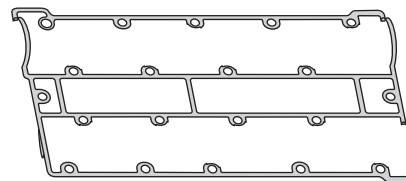

290910

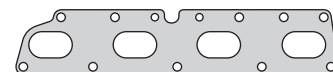

290916



290917



A 12 x 17 x 1.5 C



G 50.52 x 1.78



G 55.25 x 2.62



R240013V

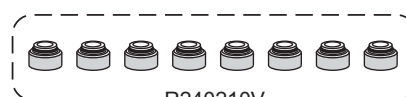

R240210V

GM / CHEVROLET

CHEVROLET



Motor/Engine	Cm³	HP	Ø
F14D4	1399	101	80.5
F18D4 MPI	1796	141	80.5
Z18XER/A18XER	1796	141	80.5
939A4 (DOHC) 16V	1796	140	80.5

Alfa Romeo: 159 2005/...
Chevrolet: Cruze 1.8 2008/... - Aveo 1.4 2009/...
Fiat: Croma 2005/...
Opel: Astra H 2004/... - Signum - Vectra C 2006/... - Zafira B 2005/... - Insignia 2008/...

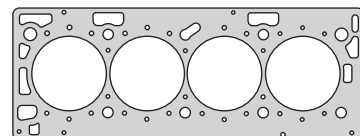

291008

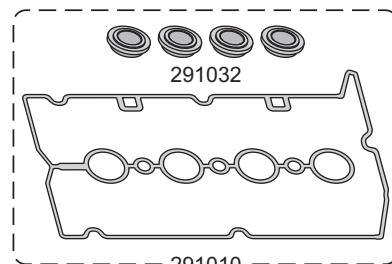

291032



291015



291017

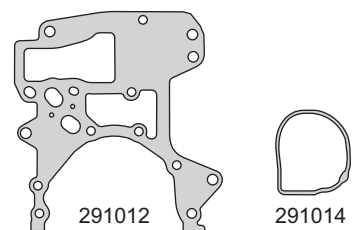

291012

291014



252318



291027



291019



291030



291031



291033



291035



G 22 x 2.7



G 24 x 3



G 14 x 2.7



G 64 x 3



R291011T



R230512V



R240013V

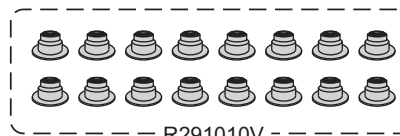

R291010V

Nº OE	Descripción/Description	Mat.	Ref.
	Jgo. de juntas para motor		291000-R MLS
93186222	Junta tapa cilindros Ø 82 ± 0.60	NFT	1 291008
	Jgo. tornillos tapa cilindros (HAE12038)		B280600
	Sellador líquido - caucho de silicona		TRN0280R
	Conj. junta tapa de válvulas (5)	GS	1 291010
	Frente motor	AL/GS	1 291012
	Bomba de agua	GS	1 291014
12992396	Múltiple escape	AC	1 291015
	Múltiple admisión	GS	1 291017
55557507	Salida de escape	AC	1 252318
55353353	Guarnición termostato	GS	1 291019
55354071	Guarnición radiador filtro aceite	GS	1 291027
	Guarnición goma	GS	1 291030
55353321	Guarnición filtro aceite	GS	1 291031
	Guarnición capuchón de bujía	GS	4 291032
	Guarnición entrada de aceite	GS	2 291033
55353319	Guarnición filtro aceite	GS	1 291035
	O´ring G 14 x 2.7	GS	2
	O´ring G 22 x 2.7	GS	2
	O´ring G 24 x 3	GS	2
	O´ring G 64 x 3	GS	1
	Kit de retenes completo		R291000
	Jgo. retén válvulas (16)	V	1 R291010V
55555805	Retén bancada	T	1 R291011T
55563374	Retén distribución 32 x 42 x 7	V	1 R230512V
	Retén árbol levas 35 x 48 x 7	V	2 R240013V

GM / CHEVROLET

CHEVROLET



Motor/Engine	Cm³	HP	Ø
Z20DM	1991	121/126	83
Z20S/DMH (SOHC) 16V	1991	150	83

Chevrolet: Epica - Optra 2006/11 - Lacetti - Nubira Captiva - Tosca 2007/... - Cruze 2009/...
Daewoo: Epica - Captiva - Toscana 2006/...
Opel: Antara 2006/10



DIESEL

Nº OE	Descripción/Description	Mat.	Ref.
	Jgo. de juntas para motor		291101-R
	Junta tapa cilindros Ø 89 \pm 1.10	MLS	291108-1M
	Junta tapa cilindros Ø 89 \pm 1.20	MLS	291108-2M
	Junta tapa cilindros Ø 89 \pm 1.30	MLS	291108-3M
	Jgo. de tornillos para tapa de cilindros		B291100
	Sellador líquido - caucho de silicona		TRN0280R
	Junta tapa válvulas	GS 1	291110
	Bomba de agua	NB 1	291114
	Múltiple escape	AC 1	291115
	Jgo. múltiple escape (5)	SLS 1	291116
	Múltiple admisión	NB 1	291117
	Salida de escape	NB 1	291118
	Junta termostato	NB 1	291119
	Junta	NB 1	291132
	Junta	NB 1	291133
	Junta	NB 1	291134
	Kit de retenes completo		R291100
	Jgo. retén válvulas (16)	P 1	R291110P
	Retén bancada 98 x 114 x 8	P 1	R291111V
	Retén distribución 32 x 45 x 6	P 1	R291112P
	Retén árbol de levas 36 x 50 x 8	P 1	R460213P

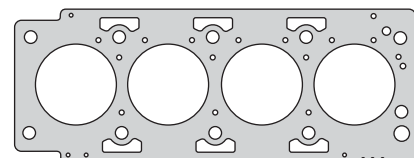

291108



291110

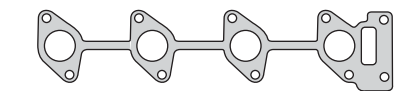

291115

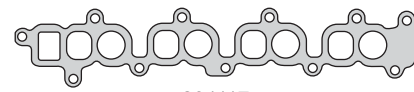

291117

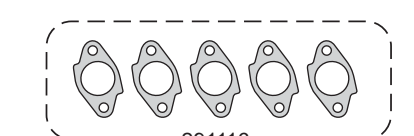

291116

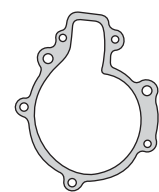

291114

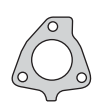

291118



291119

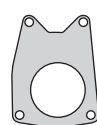

291132



291134



291133



R291111P



R291112P



R460213P

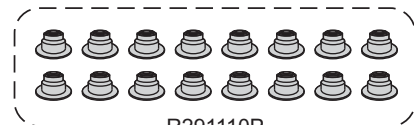

R291110P

GM / CHEVROLET



taranto

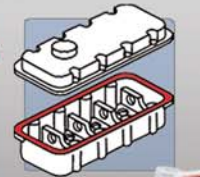
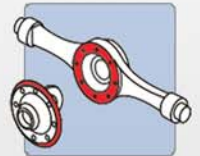

Sellador Líquido a base de Caucho de Silicona

Aprobado para motores equipados con sensor de oxígeno.

- ▶ Sellador libre de solvente, adhesivo y cubritivo compuesto a base de caucho de silicona, ha sido especialmente creado para aplicaciones de gran fuerza de torsión.
- ▶ Excelente resistencia al aceite a los combustibles, aceites, lubricantes, anticongelantes y gases.
- ▶ Resiste golpes y vibraciones.
- ▶ Es siempre flexible y se mantiene a una temperatura de entre -62°C a +350°C intermitente.

No recomendado para sellar tapas de cilindros.

**HIGH
TEMP
350°C**













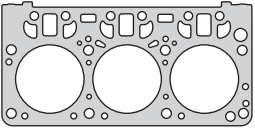

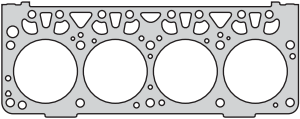



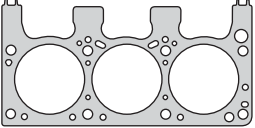

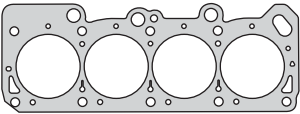

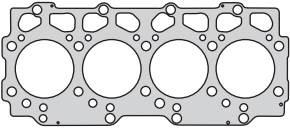

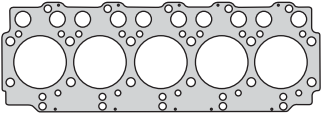
MOTORES NAFTA - DIESEL

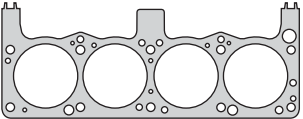
220005 	Código	Ø	⊗	Kit Bulón	Modelo
	220005	89.0	1.40		Valiant I/II/III/IV D100 - D2800 - Polara - Coronado - RT 1964/79
220105 - 220106 	Código	Ø	⊗	Kit Bulón	Modelo
	220105 220106	88.0 88.0	1.40 2.40	B220100	D1500 - D1800 Paikan - GT90 - GT100 1971/...
220505 	Código	Ø	⊗	Kit Bulón	Modelo
	220505	102.0	1.40		GTX - Coupe 1970/...
220705 	Código	Ø	⊗	Kit Bulón	Modelo
	220705	88.0	1.40		Continental 3 3/8 - 3 7/16 - D100 - 200 - 400 - 500 1951/64
220907 	Código	Ø	⊗	Kit Bulón	Modelo
	220907	102.0	1.20	B220900	Grand Cherokee Laredo - Cherokee - Cherokee Sport - Comanche Wagoneer - Wrangler 1986/91
230407 	Código	Ø	⊗	Kit Bulón	Modelo
	230407	88.0	1.20	B230400 (HAS15038)	Neón 1997/99 Neón - Cirrus - Stratus - Voyager 1996/01
230807 	Código	Ø	⊗	Kit Bulón	Modelo
	230807	89.0	1.40	B230800	Neón - Sebring - Avenger 1995/... - Stratus - Cirrus - Plymouth Breeze Caravan - Grand Caravan - Voyager - Grand Voyager 1995/00
510007 	Código	Ø	⊗	Kit Bulón	Modelo
	510007	96.0	1.90	B510000 (HAS15038)	Caravan - Grand Caravan - Imperial - Voyager - Grand Voyager New Yorker - Town & Country 1990/99
510107 	Código	Ø	⊗	Kit Bulón	Modelo
	510107	98.0	1.90	B510000 (HAS15038)	Caravan - Grand Caravan - Voyager - Grand Voyager - New Yorker Imperial - Town & Country 1991/99
510407 	Código	Ø	⊗	Kit Bulón	Modelo
	510407	103.5	1.80		Dakota - Pick Up - Jeep Cherokee - Comanche - Wrangler Renegade 1991/96
					Motor
					2788cc. 170 130HP Ø86,36 3687cc. 225 130HP Ø86,36 (220000-R) pág. 98
					1498cc. Hillman 72HP Ø86 3687cc. Hillman 110HP Ø86 (220100-R) pág. 99
					5210cc. 318 V8 202HP Ø99.31 (220500) pág. 100
					3956cc. 241 95HP Ø85.73 4106cc. 251 100HP Ø87.31 (220700) pág. 101
					3960cc. 240 - 242/L 185HP Ø98.4 (220900) pág. 102
					1796cc. 122 CID (SOHC) 16V 116HP Ø83 1996cc. ECB/420H (SOHC) 16V 132HP Ø87.5 (230400-R) pág. 103
					1996cc. 4A20 (DOHC) 16V 130/140HP Ø87.5 (230800-R) pág. 104 2429cc. EDZ 150HP Ø87.5 (521400-R) pág. 122
					3301cc. 201 (R00) V6 152/162HP Ø93 (510000-R) pág. 105
					3778cc. 231 (L00) V6 162/166HP Ø96 (510100-R) pág. 106
					2464cc. D150 121HP Ø98.4 (510400-R) pág. 108

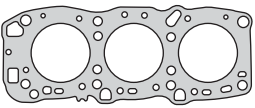

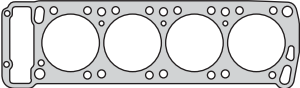
MOTORES NAFTA - DIESEL

	510507	Código	Ø	⊘	Kit Bulón	Modelo	Dakota Pick Up 1996/...
		510507	102.5	1.40		Motor	3900cc. V6 130HP Ø99.3 (510500-R)  pág. 109
	510707	Código	Ø	⊘	Kit Bulón	Modelo	Grand Cherokee 1993/...
		510707	104.0	1.20		Motor	5210cc. 318 V8 215/223HP Ø99.3 (510700-R)  pág. 110
	510807 - 510907	Código	Ø	⊘	Kit Bulón	Modelo	Grand Wagoneer 1984/88 - Pick Up 1981/88 - Scrambler 1981/86 Jeep CJ - DJ 1981/86 - Wrangler - Jeep YJ 1986/90
		510807	99.0	1.20		Motor	4200cc. 258 AMC Jeep 170HP Ø95.25 (510800-R)  pág. 111
		510907	99.0	1.20			4200cc. 258 AMC Jeep 170HP Ø95.25 (510900-R)  pág. 112
	520107	Código	Ø	⊘	Kit Bulón	Modelo	Pick Up V6 1987/91
		520107	103.0	1.30		Motor	3910cc. 239 CID V6 130HP Ø99.31 (520100-R)  pág. 113
	520205 - 520207	Código	Ø	⊘	Kit Bulón	Modelo	135 (EDR) Lebaron - Spirit - Shadow - Voyager - Phantom - Caravan Daytona 1982/98 - EDM(K00) Caravan - Grand Caravan - Grand Voyager Saratoga 1986/95 - EDT Voyager - Caravan - Lebaron - Daytona 1989/92
		520205	89.0	1.80		Motor	2313cc. 135 (EDR) - 2501cc. EDM/EDT Ø87.5 (520200-R)  pág. 114
		520207	89.0	1.90			2313cc. 135 (EDR) - 2501cc. 153 EDT Ø87.5 (521200-R)  pág. 121
	520307 - 520308	Código	Ø	⊘	Kit Bulón	Modelo	Dakota TD - Grand Voyager TD 1995/...
		520307-SM	98.0	1.40	B520300	Motor	2499cc. VM425TD 114/115HP Ø92 (520301-R)  pág. 456
		520307-1M	98.0	1.50			
		520307-2M	98.0	1.60			
		520308-SM	98.0	1.42			
		520308-1M	98.0	1.52			
	520308-2M	98.0	1.62				
	520407 - 520408	Código	Ø	⊘	Kit Bulón	Modelo	Jeep Cherokee - Grand Cherokee - Dakota - Caravan 2001/...
		520407-SM	98.0	1.40	B520400	Motor	3100cc. VM531TD 142HP Ø92 (520401-R)  pág. 457
		520407-1M	98.0	1.50			
		520407-2M	98.0	1.60			
		520408-SM	98.0	1.42			
		520408-1M	98.0	1.52			
	520408-2M	98.0	1.62				
	520505	Código	Ø	⊘	Kit Bulón	Modelo	Charger - Dart GTS - Le Baron - Cordoba - Monaco - Super Bee Camiones Ligeros D350/D600 1979/92 - Barracuda, Super Bee 1970/74
		520505	104.0	1.20		Motor	5900cc. 360 Con Carburador y T.B.I (520500-RMX)  pág. 115 5210cc. 318 LA V8 202HP Ø99.3 (510200-R)  pág. 107
	520607	Código	Ø	⊘	Kit Bulón	Modelo	Stratus - Avenger - Sebring - Cirrus 1995/99
		520607	87.0	1.40		Motor	2497cc. 150 (H00) (SOHC) V6 24V 167HP Ø83.5 (520600-R)  pág. 116
	520805	Código	Ø	⊘	Kit Bulón	Modelo	Pick Up - Lebaron - Caravan 1981/89
		520805	94.0	1.20		Motor	2555cc. G54B (520800-RMX)  pág. 117



MOTORES NAFTA - DIESEL

520905 - 520907

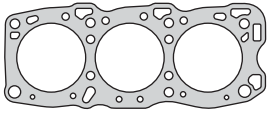

Código	Ø	≠	Kit Bulón
520905	95.0	1.50	
520907	95.0	1.60	

Modelo	Pick Up 1987/96 - Caravan
Motor	3000cc. 181 V6 (520900-RMX) pág. 118

521008

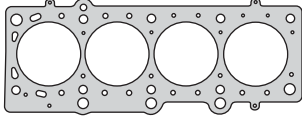

Código	Ø	≠	Kit Bulón
521008	89.5	1.00	

Modelo	Neon 2000/05
Motor	1196cc. 135HP (SOHC) 16V Ø87,5 (521000-R) pág. 119

521108

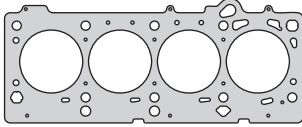

Código	Ø	≠	Kit Bulón
521108	88.0	0.70	

Modelo	PT Crusier 2002/05 - Stratus 2002/6
Motor	1196cc. ECC 150HP Ø87,5 (521100-R MLS) pág. 120 2429cc. EDZ 150HP Ø87,5 (521500-R) pág. 123 2429cc. EDZ 150HP Ø87,5 (522100-R) pág. 129

521608

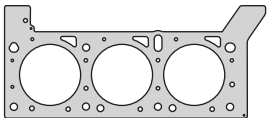

Código	Ø	≠	Kit Bulón
521608	97.2	0.75	B510000 (HAS15038)

Modelo	Voyager 2002/06 - Pacifica 2004/07
Motor	3778cc. EGH 162HP Ø96 (521600-R) pág. 124

521708

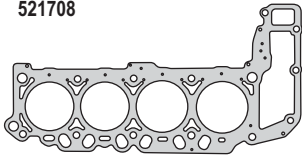

Código	Ø	≠	Kit Bulón
521708	93.7	0.75	

Modelo	Dakota - Ram 1500 2000/11 - Grand Cherokee - Durango 1999/09 Aspen - Commander 2006/09
Motor	4698cc. V8 Magnum 235HP Ø93 (521700-R) pág. 125

521808

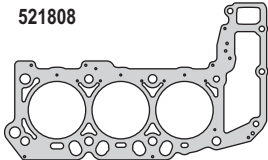

Código	Ø	≠	Kit Bulón
521808	93.75	0.70	

Modelo	Dakota - Ram 1500 - Durango 2000/09 Jeep Liberty - Grand Cherokee 2002/09
Motor	3701cc. EKG V6 (SOHC) 12V 210HP Ø93 (521800-R) pág. 126

521908

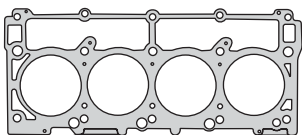

Código	Ø	≠	Kit Bulón
521908	100.0	0.75	

Modelo	Ram 2500, Ram 3500, Ram Quad, Charger, Jeep Comander Sonora, 300C, Grand Cherokee, Aspen
Motor	5645cc. V8 Hemi 345HP Ø99.5 (521900-RMX) pág. 127

522007

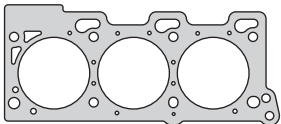

Código	Ø	≠	Kit Bulón
522007	100.0	1.40	

Modelo	Concorde, New Yorker LHS
Motor	3518cc. EGE 214HP Ø96 (522000-R) pág. 128

523008

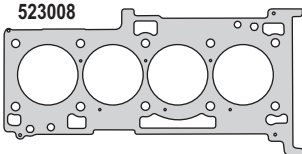

Código	Ø	≠	Kit Bulón
523008	89.0	0.50	

Modelo	Jeep - Avenger - Patriot - Caliber - Compass - Sebring - Stratus 2007/... Journey - Compass 2009/...
Motor	2360cc. ED3 - GEMA (DOHC) 16V 170/174HP Ø88 (523000-R MLS) pág. 130

910507

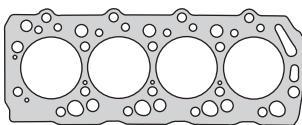

Código	Ø	≠	Kit Bulón
910507	92.0	1.70	B910500 (HAH10055) (HAH10140)

Modelo	Pick Up Power Ram 50 TD 1983/85
Motor	2346cc. 4D55T 67HP Ø91 DIESEL (910500-R)

961507

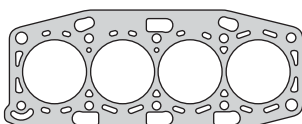

Código	Ø	≠	Kit Bulón
961507	82.5	1.60	B961507

Modelo	Vista - Colt 1992/94
Motor	1834cc. 4G93 (SOHC) 16V 120HP Ø81 (961500-R)

CHRYSLER



Motor/Engine	Cm³	HP	Ø
170	2788	130	86.36
225	3687	130	86.36

Dodge: Valiant I/II/III/IV D100 - D2800 - Polara
Coronado - RT 1964/79

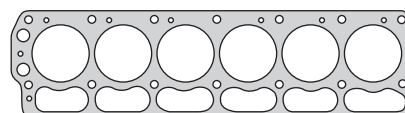

220005

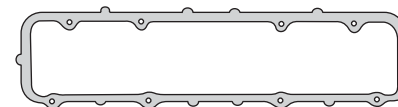

220010

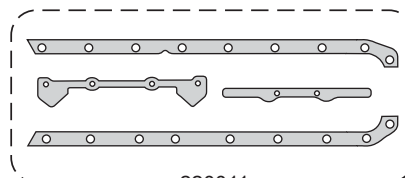

220011



220016

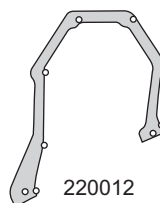

220012



220014



220017



220018



220019



220025



220027



220028



220032



220029



A 13 x 20 x 2 A



220058



R220012N



R220013P



R300010P

Nº OE	Descripción/Description	Mat.	Ref.
2488777	Jgo. de juntas para motor		220000-R
	Jgo. de juntas superior	●	220095
1947578	Junta tapa cilindros Ø 89 ± 1.40	NFT 1 1	220005
2406625	Junta tapa válvulas superior	CG 1 1	220010
2240697	Jgo. junta para cárter (4)	CG 1 1	220011
1947553	Tapa distribución	NB 1 1	220012
1947523	Tapa bomba de agua	NB 1 1	220014
2084416	Múltiple admisión y escape	NFT 1 1	220016
2206120	Entre múltiples	NFT 1 1	220017
2073972	Salida de escape	FCH 1 1	220018
1947521	Bomba agua a block	NB 1 1	220019
	Jgo. juntas carburador HOLLEY	VS	220020
	Jgo. juntas carburador HOLLEY	VS	220021
2205582	Base carburador	NB 1 1	220025
	Tapa carburador HOLLEY RX 7001/7005	CG	220026
2121404	Bomba aceite a block	NB 1 1	220027
1400185	Base bomba nafta	NB 1 1	220028
1947708	Arandelas bujias	GS 6 6	220029
1947671	Termostato	CB 1 1	220032
	Tapa diferencial DANA 44	CG	540034
	Jgo. juntas caja velocidades VAL. I - II	VS	220050
	Jgo. juntas caja velocidades III - IV	VS	220051
	Jgo. juntas caja velocidades CORONADO	VS	220052
	Jgo. juntas caja velocidades 3 V	VS	220053
2084411	Jgo. juntas empaquetadura bancada (2)	SNA 1	220058
2240697	Tapa diferencial DANA 44	CGT	540068
	Jta. tapa cilindros competición (0.80)	TEF	210090-0.80
	Jta. tapa cilindros competición (1.00)	TEF	210090-1.00
	Jta. tapa cilindros competición (1.20)	TEF	210090-1.20
	Jta. tapa cilindros competición (0.80)	TEF	210091-0.80
	Jta. tapa cilindros competición (1.00)	TEF	210091-1.00
	Jta. tapa cilindros competición (1.20)	TEF	210091-1.20
	Arandela tapón cárter A 13 x 20 x 2 A	AL	
	Kit de retenes completo		R220000
	Jgo. retén válvulas (12)	P 1	R300010P
	Retén distribución 53.97 x 80.96 x 14.68	N 1	R220012N
	Retén árbol de levas 57.15 x 80.98 x 11.5	P 1	R220013P

CHRYSLER / DODGE

CHRYSLER



Motor/Engine	Cm³	HP	Ø
Hillman	1498	72	86
Hillman	1798	110	86

Dodge: D1500 - D1800 - Paikan - GT90
GT100 1971/...

Volkswagen: 1500 - 1800 1982/...



Nº OE	Descripción/Description	Mat.	Ref.
	Jgo. de juntas para motor		220100-R
	Jgo. de juntas superior		220195
71241047	Junta tapa cilindros Ø 88 ± 1.40	NFT 1 1	220105
	Junta tapa cilindros Ø 88 ± 2.40	NFT	220106
	Jgo. de tornillos para tapa de cilindros		B220100
71244439	Junta tapa válvulas	CG 1 1	220110
71244432	Junta para cárter	CG 1	220111
71300122	Tapa distribución	NB 1	220112
71241043	Tapa bomba de agua	NB 1	220114
71241094	Múltiple admisión y escape	CHA	220115
71241094	Múltiple admisión y escape	NFT 1 1	220116
	Entre múltiple	NFT 1 1	220117
71248090	Salida de escape	FCH 1 1	220118
2068331	Termostato	CB 1 1	220119
71305081	Jgo. juntas carburador STROMBERG	VS	220120
85G7007N	Jgo. juntas carburador HOLLEY RX 7034 A	VS	220121
85G7008N	Jgo. juntas carburador HOLLEY RX 7035 A	VS	220122
71235148	Base carburador	NB 2	220125
	Bomba aceite	NB 1	220127
71240978	Bomba nafta	NB 2	220128
	Bastón cierre bancada	N 2	220131
71301430	Base carburador HOLLEY 1,5	NB 2 2	220132
	Base carburador HOLLEY 1,8	NH	220133
7080341	Tapa carburador STROMBERG	CB	220134
75061327	Cebador carburador STROMBERG	CB	220135
	Base filtro aire	CB	220136
71035003	Jgo. juntas caja velocidades	CB	220150
75064744	Jgo. juntas caja velocidades AUTOMATICO	VS	220151
	Tapa diferencial TRANSAX - DANA 30	CG	450355
	Palier brasilero	CB	220156
	Diferencial brasilero	CB	220159
71244432	Junta para cárter	CGT	220160
71244439	Junta tapa válvulas	CGT	220161
	Palier nacional	CB	220162
	Tapa diferencial TRANSAX - DANA 30	CGT	450362
	Jta. tapa cilindros competición (0.80)	NFT	220290-0.80
	Jta. tapa cilindros competición (1.00)	NFT	220290-1.00
	Jta. tapa cilindros competición (1.20)	NFT	220290-1.25
	Arandela tapón cárter A 13 x 20 x 2 A	AL	
	Kit de retenes completo		R220100
	Jgo. retén válvulas (8) 1.5	P 1	R220110P
	Jgo. retén válvulas (8) 1.8	P	R220210P
	Retén bancada 76.2 x 95.22 x 9.32	N 1	R220111N
	Retén distribución 44.45 x 63.5 x 9.52	P 1	R220112P

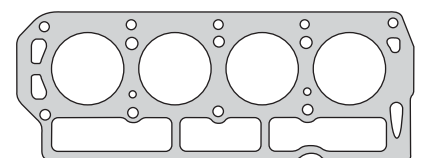

220105

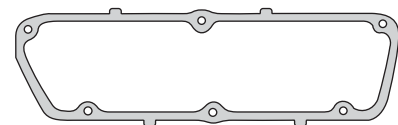

220110

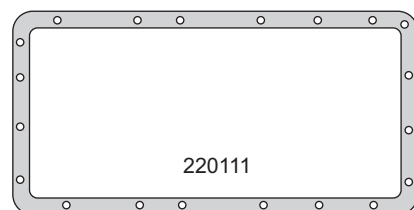

220111

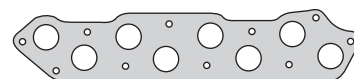

220116

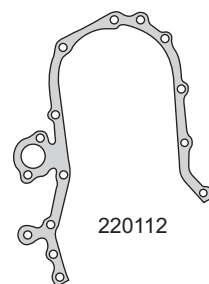

220112

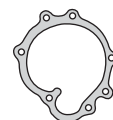

220114



220117



220118



220119



220127



220125



220131



220128



220132



A 13 x 20 x 2 A



R220111N



R220112P



R220110P

CHRYSLER



Motor/Engine	Cm³	HP	Ø
318 V8	5210	202	99.31

Dodge: GTX - Coupe 1970/...



CHRYSLER / DODGE

Nº OE	Descripción/Description	Mat.	Ref.
	Jgo. de juntas para motor		220500
2463338	Jgo. junta tapa cilindros Ø 102 \pm 1.40 (2)	NFT 1	220505
3658869	Conjunto tapa válvulas superior	CG 2	220510
3518879	Jgo. junta para cárter (4)	CG 1	220511
2129012	Tapa distribución	NB 1	220512
2129013	Cuerpo bomba de agua	NB 1	220514
	Jgo. múltiple escape (6)	NFT 1	220515
2536514	Jgo. múltiple admisión (2)	NFT 1	220517
50082	Codo salida agua	NB 1	220519
2468818	Base carburador	NB 2	220525
1400185	Base bomba nafta	NB 1	220528
2268513	Tapón cárter A 14 x 20 x 1.5 A	AL 1	220529
2806095	Delantera múltiple admisión	CG 1	220530
2806096	Trasera múltiple admisión	CG 1	220531
	Jgo. juntas empaquetadura bancada (2)	SNA 1	220558
	Retén distribución 52.50 x 80.96 x 19.05	N	R220512N

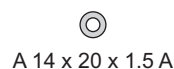
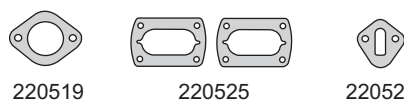
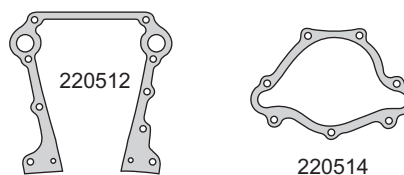
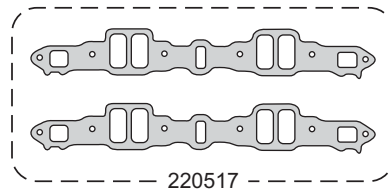
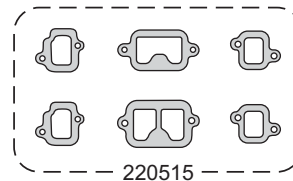
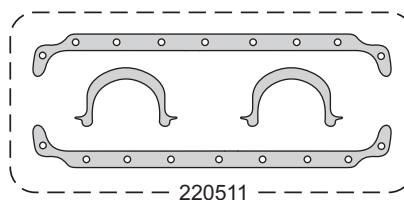
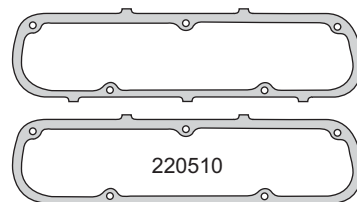
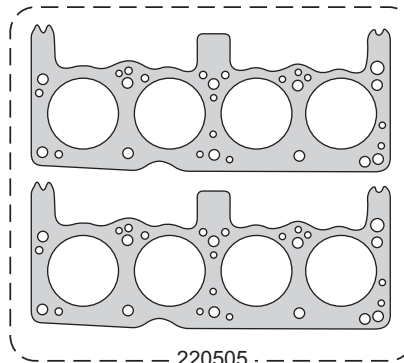

CHRYSLER



Motor/Engine	Cm³	HP	Ø
241	3956	95	85.73
251	4106	100	87.31

Dodge: Continental 3 3/8 - 3 7/16
D100/200/400/500 1951/64



Nº OE	Descripción/Description	Mat.	Ref.
	Jgo. de juntas para motor		220700
	Junta tapa cilindros Ø 88 ± 1.40	NFT	1 220705
665690	Junta tapa válvulas	CG	2 220710
7800478	Jgo. junta para cárter (4)	CG	1 220711
600752	Tapa distribución	CB	1 220712
600749	Placa distribución	CB	1 220713
637439	Bomba de agua hasta 1948	NB	1 220714
780462	Jgo. múltiple admisión y escape (5)	NFT	1 220716
666352	Entre múltiple	NFT	1 220717
679023	Salida de escape D-100	FCH	220018
683051	Salida de escape D-400	FCH	220718
637440	Bomba de agua a block	NB	1 220719
	Base carburador	NB	540025
	Cuba carburador	FCH	220726
	Bomba aceite	FCH	220727
634704	Bomba nafta	FCH	220728
50082	Termostato	FCH	220729
	Bomba agua 49/	NB	1 220730
	Intermedia carburador	FCH	220734
695442	Base filtro aceite	FCH	220735
	Arandela tapón cárter A 13 x 20 x 2 A	AL	
1088603	Retén distribución 55.56 x 81 x 17.46	N	R220712N

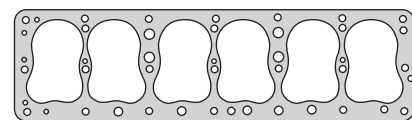

220705



220710

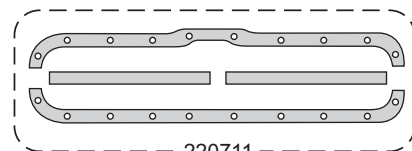

220711

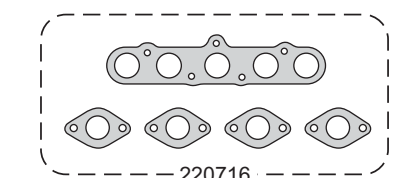

220716

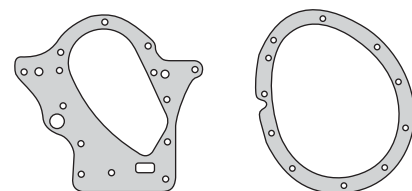

220713

220712



220714

220717

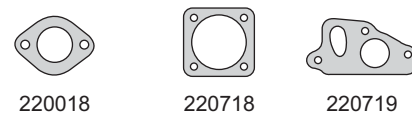

220018

220718

220719

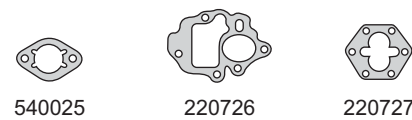

540025

220726

220727

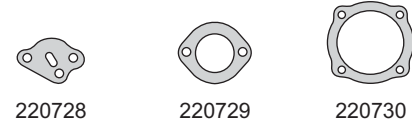

220728

220729

220730



220734

220735



A 13 x 20 x 2 A



R220712N

CHRYSLER



Motor/Engine	Cm ³	HP	Ø
240 - 242/L	3960	185	98.4

Jeep: Grand Cherokee Laredo - Cherokee
Cherokee Sport - Comanche - Wagoneer
Wrangler 1986/91



CHRYSLER / DODGE

Nº OE	Descripción/Description	Mat.	Ref.
	Jgo. de juntas para motor		220900
	Junta tapa cilindros Ø 102 ± 1.20	NFT	1 220907
	Jgo. de tronillos para tapa de cilindros		B220900
	Junta tapa de válvulas	CG	1 220910
	Junta para cárter moldeado 1991/95	GS	1 220911
	Jgo. junta para cárter 1987/90 (2)	CG	1 220911-1
	Tapa distribución	CB	1 220912
	Bomba de agua	CB	1 220914
	Múltiple admisión y escape 1987/90	NFT	1 220916
	Múltiple admisión y escape 1991/95	NFT	1 220916-1
52005431	Salida de escape	AC	220918
	Salida de agua	CB	1 220919
	Cuerpo válvula cierre	CB	1 220926
	Base bomba de aceite	CB	1 220927
	E.G.R.	NFT	1 220929
	Arandela tapón cárter A 14 x 24 x 1.5 A	AL	1 220930
	O'ring filtro aceite chico G 17.17 x 1.78	GS	1 220931
	O'ring filtro aceite mediano G 20.30 x 2.62	GS	1 220932
	O'ring filtro aceite grande G 63.09 x 3.53	GS	1 220933
	O'ring inyección G 21.82 x 3.53	GS	1 220934
6503155	Arandela tapa válvulas A 10 x 22 x 2 A	AC/GS	15 220935
	Cuerpo válvula cierre	CB	1 220937
	Base distribuidor	CB	1 220938
	O'ring enfriador aceite G 32.99 x 2.62	GS	1 220939
	Jta. tapa cilindros competición (0.80)	NFT	220990-0.80
	Jta. tapa cilindros competición (1.00)	NFT	220990-1.00
	Jta. tapa cilindros competición (1.20)	NFT	220990-1.20
	Jta. tapa cilindros competición (0.80)	NFT	220991-0.80
	Jta. tapa cilindros competición (1.00)	NFT	220991-1.00
	Jta. tapa cilindros competición (1.20)	NFT	220991-1.20
	Kit de retenes completo		R220900
53009886/7	Jgo. retén válvulas (12)	P	R210910P
4778126AB	Retén bancada (2 mitades)	P	R510811P
33004681	Retén distribución 45 x 57.15 x 9.5	P	R510812P

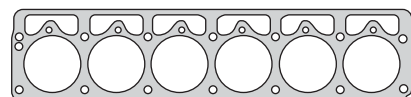

220907



220910

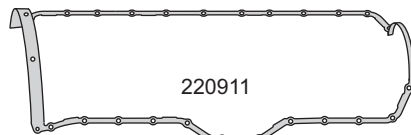

220911

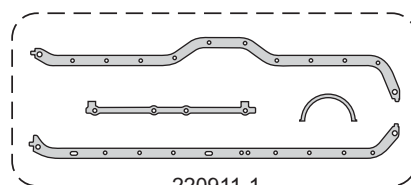

220911-1



220916



220916-1

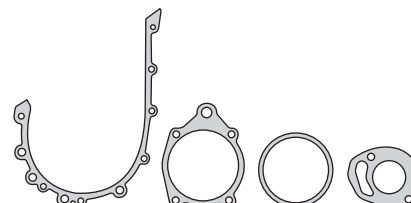

220912 220914 220918 220919

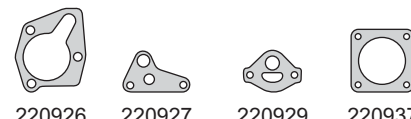

220926 220927 220929 220937



G 32.99 x 2.62 220938 G 21.82 x 3.53



G 63.09 x 3.53 G 17.17 x 1.78 G 20.30 x 2.62

A 14 x 24 x 1.5 A



A 10 x 22 x 2 A

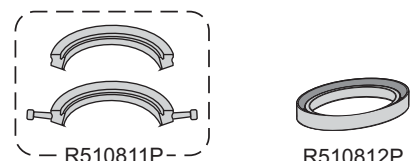

R510811P R510812P

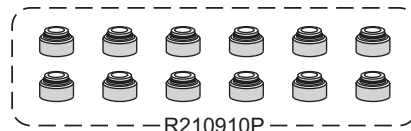

R210910P

CHRYSLER



Motor/Engine	Cm³	HP	Ø
122 CID ECB/420H (SOHC) 16V	1796 1996	116 132	83 87.5

Chrysler: Neón - Cirrus - Stratus - Voyager
1996/01 - Neon 1997/99



Nº OE	Descripción/Description	Mat.	Ref.
	Jgo. de juntas para motor		● 230400-R
0477-7072AB	Junta tapa cilindros Ø 88 ±1.20	NFT	1 230407
	Jgo. tornillos tapa cilindros (HAS15038)		B230400
0466-7985	Conj. junta tapa válvulas (5)	GS	1 230410
0455-6666	Junta para cárter (goma/metal)	GS	1 230411
0466-7663	Bomba de agua	GS	1 230414
0466-7492	Múltiple escape	NFT	1 230416
0477-7895AA	Toberas múltiple admisión (4)	GS	1 230417
	Salida de escape	AC/GS	1 230418
	Junta	NB	1 230430
	Guarnición goma	GS	1 230431
0477-7042	Jgo. junta capuchón bujías (4)	GS	1 230437
	Brida	NFT	1 230439
	Brida	NFT	1 230440
	Jgo. múltiple admisión gases (3)	NFT	1 230441
	Guarnición goma G 24 x 32 x 4.5	GS	1 230442
	Guarnición goma G 50.8 x 53.8 x 3.5	GS	230445
	Guarnición goma metal G 24 x 46.5 x 10	GS	230448
	O´ring G 48.9 x 2.62	GS	1
	O´ring G 36.09 x 3.53	GS	1
	O´ring G 37.77 x 2.62	GS	1
	O´ring G 15.47 x 3.53	GS	2
	O´ring G 7.52 x 3.53	GS	4
	O´ring G 20.3 x 2.62	GS	1
	O´ring G 26.64 x 2.62	GS	1
	Arandela tapón cárter A 19.5 x 27 x 1 A	AL	1
	Kit de retenes completo		R230400
0464-8619	Jgo. retén válvulas (16)	P	1 R230410P
0466-7904	Retén bancada 91 x 111 x 10	V	1 R330511V
0466-7198	Retén distribución 32 x 45 x 6.5	P	1 R230412P
0477-7086	Retén árbol de levas 35 x 48 x 7	P	1 R240013P

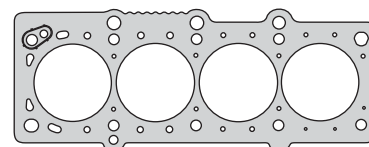

230407

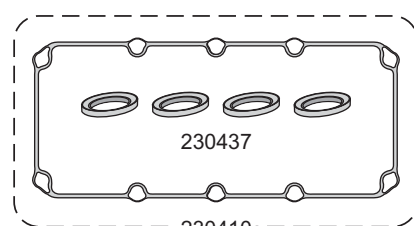

230437

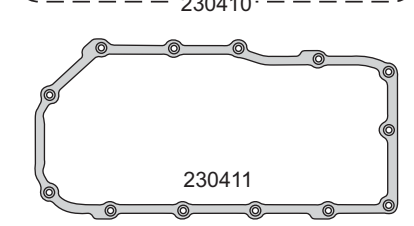

230410

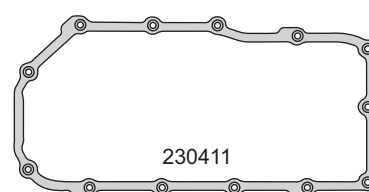

230411



230416

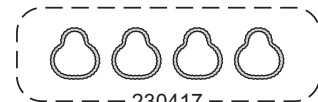

230417

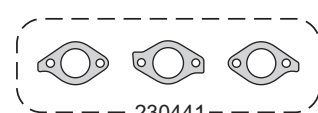

230441



230414

230418

230430

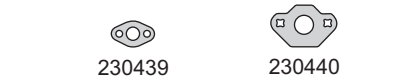

230439

230440



230442

230448

230445



A 19.5 x 27 x 1 A

G 20.3 x 2.62



G 37.77 x 2.62



G 48.9 x 2.62

G 26.64 x 2.62

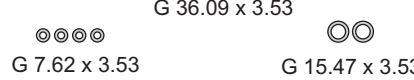

G 36.09 x 3.53



G 7.62 x 3.53

G 15.47 x 3.53

R330511V



R230412P

R240013P



R230410P

CHRYSLER / DODGE

CHRYSLER



Motor/Engine	Cm³	HP	Ø
4A20 (DOHC) 16V	1996	130/140	87.5

Chrysler: Neón - Sebring - Avenger 1995/...



CHRYSLER / DODGE

Nº OE	Descripción/Description	Mat.	Ref.
	Jgo. de juntas para motor		230800-R
	Jgo. de juntas superior	●	230895
0469-4324	Junta tapa cilindros Ø 89 ± 1.40	NFT	1 1 230807
	Jgo. de tornillos para tapa de cilindros		B230800
0466-7421	Junta tapa válvulas	GS	1 1 230810
0455-6666	Junta para cárter (goma/metal)	GS	1 1 230411
0466-7663	Bomba de agua	GS	1 1 230414
0466-7722	Múltiple escape	NFT	1 1 230816
0466-7539	Múltiple admisión	NB	1 1 230817
0466-7817	Tubo múltiple admisión	NB	1 1 230836
0527-7928	Brida	NFT	1 1 230439
0466-7232	Jgo. juntas capuchón bujías (4)	GS	1 1 230839
0466-3247	Brida	NFT	1 1 230440
0466-7420	Guarnición goma G 8.7 x 18.8 x 12.3	GS	8 1 230840
	Jgo. múltiple admisión gases (3)	NFT	1 1 230441
	Guarnición goma G 24 x 32 x 4.5	GS	1 1 230442
	Guarnición goma/metal G 24 x 46.5 x 10	GS	1 1 230448
	O´ring G 48.9 x 2.62	GS	1 1
	O´ring G 36.09 x 3.53	GS	1 1
	O´ring G 37.77 x 2.62	GS	1 1
	O´ring G 15.47 x 3.53	GS	2 1
	O´ring G 7.52 x 3.53	GS	4 1
	O´ring G 26.64 x 2.62	GS	1 1
	O´ring G 20.3 x 2.62	GS	1 1
	Arandela tapón cárter A 19.5 x 27 x 1 A	AL	1 1
	Kit de retenes completo		R230400
0464-8619	Jgo. retén válvulas (16)	P	1 R230410P
0466-7904	Retén bancada 91 x 111 x 10	V	1 R330511V
0466-7198	Retén distribución 32 x 45 x 6.5	P	1 R230412P
0477-7086	Retén árbol de levas 35 x 48 x 7	P	1 R240013P

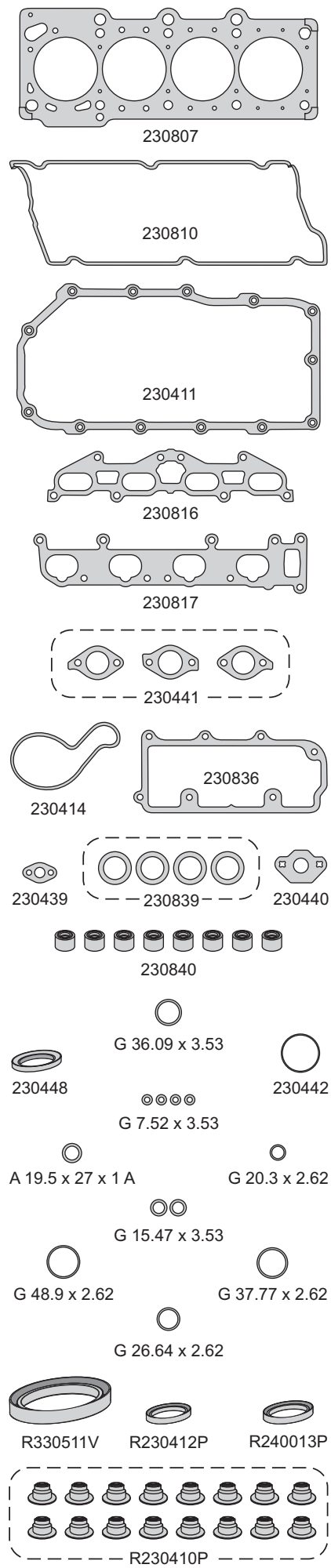

CHRYSLER



Motor/Engine	Cm³	HP	Ø
201 (R00) V6	3301	152/162	93

Chrysler: Caravan - Grand Caravan
Imperial - Voyager
Grand Voyager - New Yorker
Town & Country 1990/99



Nº OE	Descripción/Description	Mat.	Ref.
	Jgo. juntas para motor		510000-R
	Jgo. junta tapa cil. Ø 96 ± 1.90 (2)	NFT	1 510007
	Jgo. tornillos tapa cilindros (HAS15038)		B510000
	Junta tapa de válvulas	GS	2 510010
	Junta para cárter	GS	1 510011
	Tapa distribución	CB	1 510012
	Jgo. múltiple escape (2)	NFT	1 510015
	Salida de escape	NFT	510018
	Base termostato	CB	1 510019
	Junta árbol de levas	CB	1 510020
	Junta	NFT	510120
	Junta	CB	510121
	Porta retén bancada trasera	CB	1 510122
	Bomba aceite	NB	510527
	E.G.R.	NFT	510030
	Retorno aceite	NFT	510031
	Guarnición G 35 x 42 x 4.5	GS	2 510040
	Arandela tapón cárter A 13 x 23 x 1.5 C	CU	1
	O´ring G 104.37 x 3.53	GS	1
	O´ring G 34.52 x 3.53	GS	
	O´ring G 21.82 x 3.53	GS	1
	O´ring G 24 x 30 x 3.9	GS	1
	O´ring G 7.52 x 3.53	GS	12
	O´ring G 20.30 x 2.62	GS	1
	Kit de retenes completo		R510000
	Jgo. reten válvulas (12)	P	1 R510010P
	Retén bancada 91 x 111 x 10	V	1 R330511V
	Retén distribución 28.5 x 41.25 x 6	P	1 R510012P

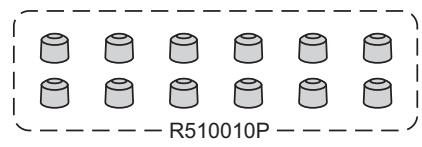
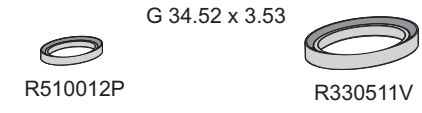
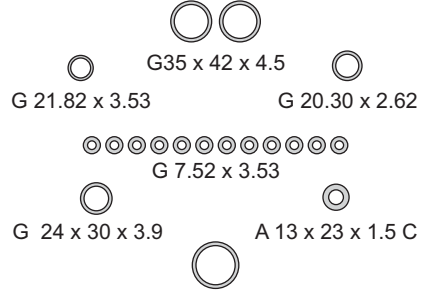
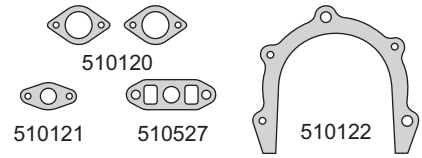
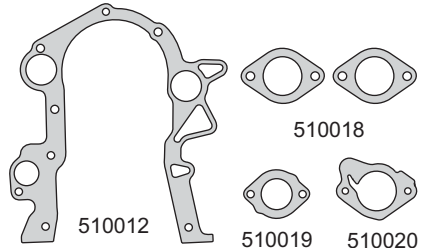
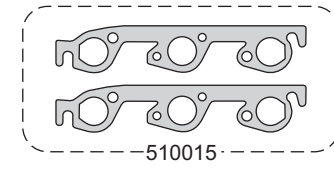
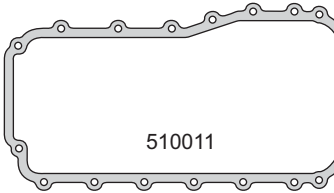
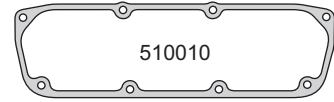
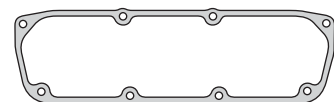
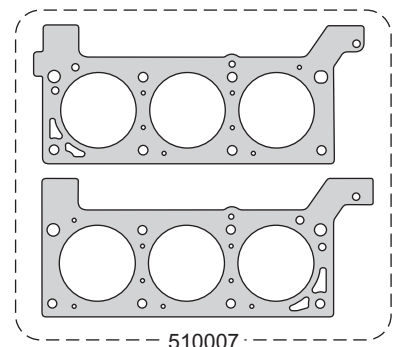

CHRYSLER / DODGE

CHRYSLER



Motor/Engine	Cm³	HP	Ø
231 (L00) V6	3778	162/166	96

Chrysler: Caravan - Grand Caravan
 Voyager - Grand Voyager
 New yorker - Imperial
 Town & Country 1991/99



CHRYSLER / DODGE

Nº OE	Descripción/Description	Mat.	Ref.
	Jgo. de juntas para motor		510100-R
	Jgo. junta tapa cilin. Ø 98 ± 1.90 (2)	NFT 1	510107
	Jgo. tornillos tapa cilindros (HAS15038)		B510000
	Junta tapa de válvulas	GS 2	510010
	Junta para cárter	GS 1	510011
	Tapa distribución	CB 1	510012
	Jgo. múltiple escape (2)	NFT 1	510015
	Salida de escape	NFT	510018
	Base termostato	CB 1	510019
	Junta árbol de levas	CB 1	510020
	Junta	NFT 2	510120
	Junta	CB 1	510121
	Porta retén bancada trasera	CB 1	510122
	E.G.R	NFT	510030
	Retorno aceite	NFT	510031
	Guarnición G 35 x 42 x 4.5	GS 2	510040
	Arandela tapón cárter A 12.8 x 22.8 x 2	PLAST	
	Arandela A 13 x 23 x 1.5 C	CU 1	
	O´ring G 104.37 x 3.53	GS 1	
	O´ring G 20.30 x 2.62	GS 1	
	O´ring G 21.82 x 3.53	GS 1	
	Anillo G 24 x 30 x 3.9	GS 1	
	O´ring G 7.52 x 3.53	GS 12	
	Kit de retenes completo		R510000
	Jgo. reten válvulas (12)	P 1	R510010P
	Retén bancada 91 x 111 x 10	V 1	R330511V
	Retén distribución 28.5 x 41.25 x 6	P 1	R510012P

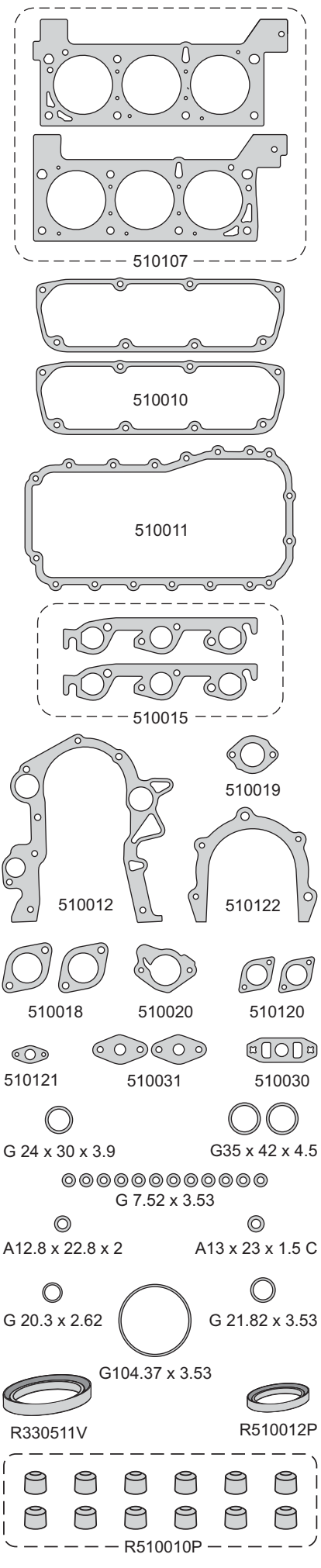

CHRYSLER



Motor/Engine	Cm³	HP	Ø
318 LA V8	5210	202	99.3

Dodge: Barracuda, Super Bee 1970/74



Nº OE	Descripción/Description	Mat.	Ref.
	Jgo. de juntas para motor		510200-R
	Jgo. junta tapa cilindros Ø 104 \pm 1.20 (2)	NFT	1 520505
3658869	Conjunto tapa válvulas superior	CG	2 220510
3518879	Jgo. junta para cárter (4)	CG	1 220511
2129012	Tapa distribución	NB	1 220512
2129013	Cuerpo bomba de agua	NB	1 220514
	Jgo. múltiple escape (6)	NFT	1 220515
2536514	Jgo. múltiple admisión (2)	NFT	1 220517
50082	Codo salida agua	NB	1 220519
	Junta	CB	1 520122
2468818	Base carburador	NB	2 220525
1400185	Base bomba nafta	NB	1 220528
2268513	Tapón cárter A 14 x 20 x 1.5 A	AL	1 220529
2806095	Delantera múltiple admisión	CG	1 220530
2806096	Trasera múltiple admisión	CG	1 220531
	Junta	AC	1 520532
	Jgo. juntas empaquetadura bancada (2)	SNA	1 220558
	Kit de retenes completo		R510200
	Jgo. retén válvulas (12)	P	1 R510210P
	Retén distribución 55 x 81 x 15.8	V	1 R510512V

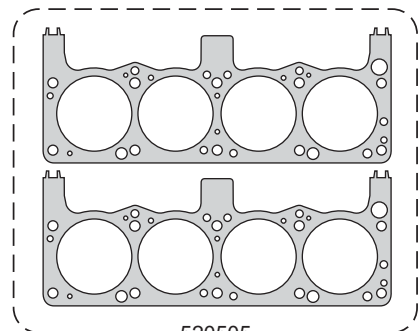

520505

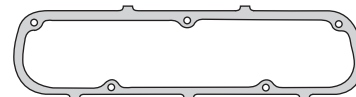

220510

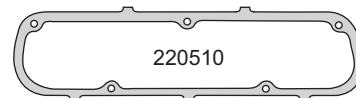

220511

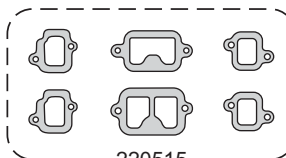
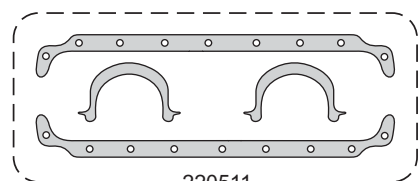

220514

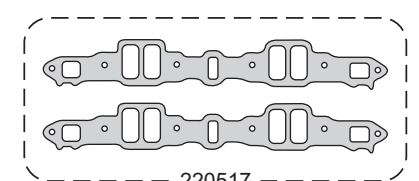

220515

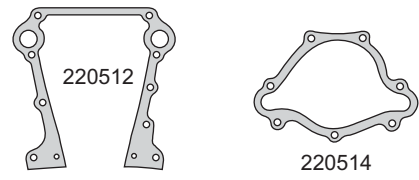

220512

220519

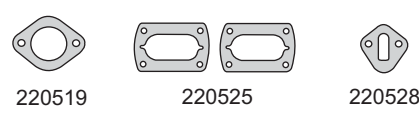

220519

220525

220528



220530

220531

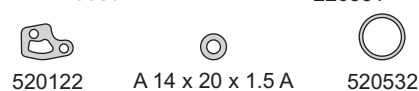

520122

A 14 x 20 x 1.5 A

520532



220558



R510512V

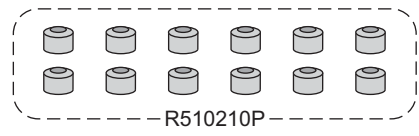

R510210P

CHRYSLER / DODGE

CHRYSLER



Motor/Engine	Cm³	HP	Ø
D150	2464	121	98.4

Chrysler: Dakota - Pick Up - Jeep Cherokee Comanche - Wrangler - Renegade 1991/96

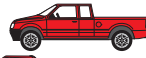

CHRYSLER / DODGE

Nº OE	Descripción/Description	Mat.	Ref.
	Jgo. de juntas para motor	●	510400-R
	Junta tapa cilindros Ø 103.5 x 1.80	NFT	1 510407
	Junta tapa de válvulas	CG	1 510410
	Junta para cárter	GS	1 510411
	Tapa distribución	CB	1 220912
	Bomba de agua	NB	1 510414
	Bomba de agua	CB	1 220914
	Múltiple admisión y escape	NFT	1 510416
	Salida de agua	CB	1 220919
	Termostato	CB	1 510019
	Bomba aceite	CB	1 220927
	Bomba nafta	CB	1 200028
	Brida		510429
	Brida	NFT	1 510430
	Anular		510432
	Guarnición bomba de agua	GS	510435
	Junta	CB	1 200037
	O´ring G 47.22 x 3.53	GS	1
	O´ring G 7.52 x 3.53	GS	8
	Kit de retenes completo		R510400
	Jgo. retén válvulas (8)	P	1 R510410P
	Retén bancada 76.2 x 9.25 x 9.5	S	1 R510411S
	Retén distribución 44.45 x 57.15 x 9.5	S	1 R510412S

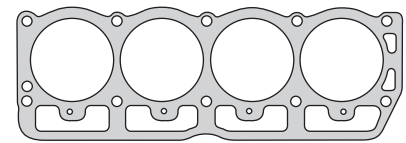

510407

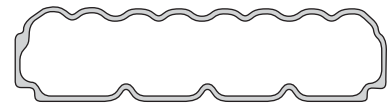

510410

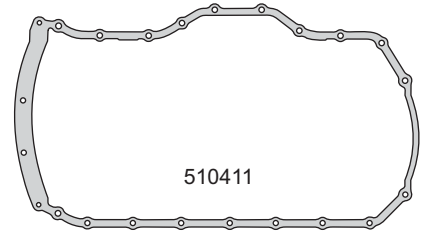

510411

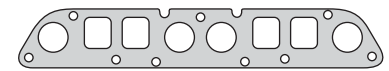

510416

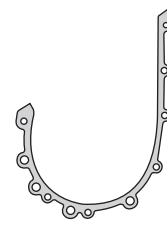

220912



220914

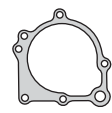

510414



220919



510019



220927



200028



510429



510430



510432



200037



G 47.22 x 3.53



510435



G 7.52 x 3.53



R510411S



R510412S



R510410P

CHRYSLER



Motor/Engine **3900** **HP** **130** **Ø** **99.3**

Chrysler: Dakota Pick Up 1996/...



Nº OE	Descripción/Description	Mat.	Ref.
	Jgo. de juntas para motor		● 510500-R
	Jgo. de juntas para motor		510500
	Jgo. de juntas superior	●	510595
	Jgo. tapa cilin. Ø102.5 ± 1.40 (2) NR	NFT 1 1	510507
	Junta tapa de válvulas	GS 2 2	510510
	Junta para cárter	GS 1 1	510511
	Tapa distribución	CB 1 1	510512
	Placa distribución	CB 1 1	510513
	Tapa bomba de agua	CB 1 1	510514
	Jgo. múltiple escape (2)	NFT 1 1	510515
	Jgo. múltiple admisión (4)	GFT 1 1	510517
	Tapa termostato	CB 1 1	510519
	Junta bomba aceite	NFT 1 1	510527
	Junta entrada de aire	CB 1 1	510529
	Unión admisión trasera	CG 1 1	510530
	Unión admisión delantera	CG 1 1	510531
	Tapa admisión	NFT 1 1	510532
	Base termostato	CB 1 1	510536
	Arandela porta retén A 104 x 118 x 1.6	CB 1 1	510533
	Arandela A 129 x 141	CB 1 1	510534
	Arandela A 30 x 46 x 3	GS 1 1	510535
	Brida	GFT 1 1	510546
	Unión cañería	CB 2 2	510545
	Brida conducto aire	CB 2 2	510544
	O´ring G 45.36 x 3.53	GS 1 1	
	O´ring G 7.52 x 3.53	GS 12 12	
	Arandela tapón cárter A 13 x 23 x 1.5 C	CU 1 1	
	Kit de retenes completo		R510500
	Jgo. retén válvulas (12)	P 1 1	R510510P
	Jgo. retén bancada (dos mitades)	P 1 1	R510511P
	Retén distribución 55 x 81 x 15.8	V 1 1	R510512V

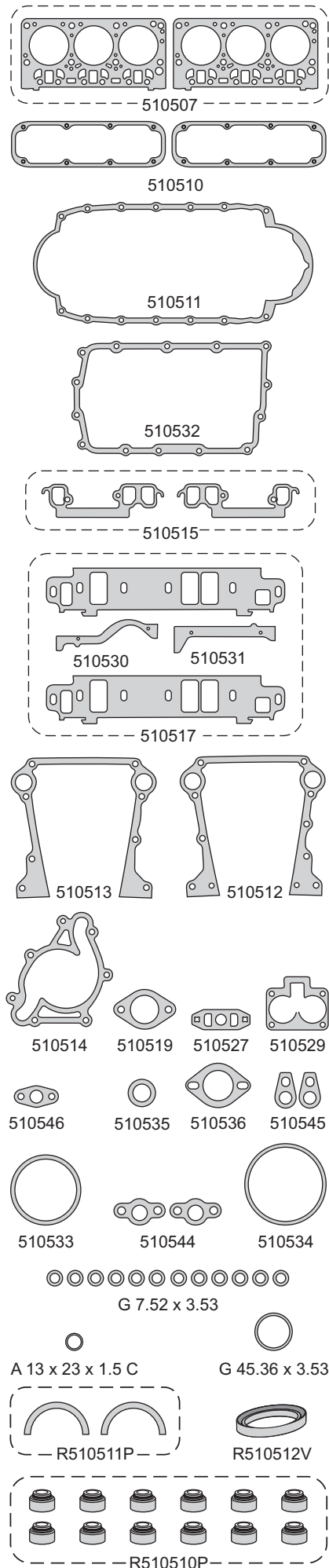

CHRYSLER / DODGE

CHRYSLER



Motor/Engine	Cm ³	HP	Ø
318 V8	5210	215/223	99.3

Jeep: Grand Cherokee 1993/...

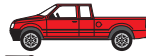

CHRYSLER / DODGE

Nº OE	Descripción/Description	Mat.	Ref.
	Jgo. de juntas para motor		510700-R
	Jgo. de juntas superior	●	510795
	Jgo. tapa cilin. Ø104 ± 1.20 (2)	NFT 1 1	510707
	Jgo. junta tapa de válvulas (2)	CG 1 1	510710
	Junta para cárter	GS 1 1	510711
	Placa distribución	CB 1 1	510513
	Tapa bomba de agua	CB 1 1	510514
	Jgo. múltiple escape (2)	NFT 1 1	510715
	Jgo. múltiple admisión (2)	NFT 1 1	510717
	Tapa termostato	CB 1 1	510519
	E.G.R	NFT	510030
	Unión admisión trasera	CG 1 1	510530
	Unión admisión delantera	CG 1 1	510531
	Tapa admisión	NB 1 1	510732
	Arandela porta retén A 104 x 118 x 1.6	CB 1 1	510533
	Arandela A 129 x 141	CB 1 1	510534
	Brida conducto aceite	CB 3 1	510544
	Unión cañería	CB 2 1	510545
	Brida E.G.R	GFT 1 1	510546
	O'ring G 45.69 x 2.62	GS 1 1	
	O'ring G 15.60 x 1.78	GS 1 1	
	Arandela tapón cárter A 13 x 20 x 2 A	AL 1 1	
	Kit de retenes completo		R510700
	Jgo. retén válvulas (16)	P 1 1	R510710P
	Retén bancada (2 mitades)	S 1 1	R510711-1S
	Retén distribución 55 x 81 x 15.8	V 1 1	R510512V

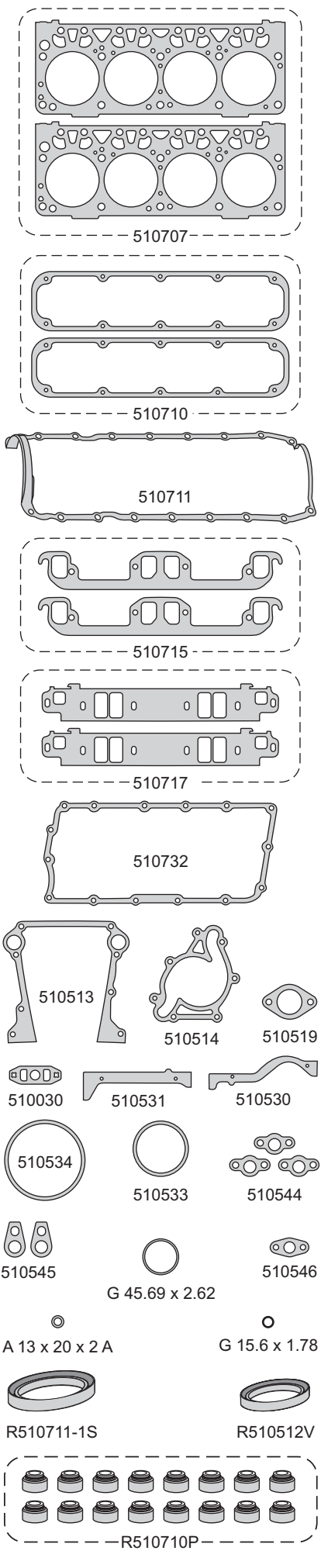

CHRYSLER



Motor/Engine	Cm³	HP	Ø
258 AMC Jeep	4200	170	95.25

Chrysler: Grand Wagoneer 1984/88
 Pick Up 1981/88
 Scrambler 1981/86
 Jeep CJ/DJ 1981/86



510807



510810

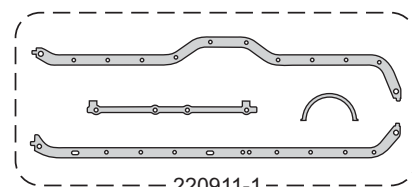

220911-1

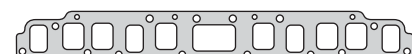

510816

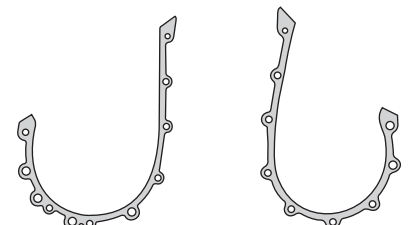

220912

510912



220914



220919



220927



510827



200028



510829



510830



510831



510832



G 66.5 x 80



220938



G 63.09 x 3.53



R510812P

Nº OE	Descripción/Description	Mat.	Ref.
	Jgo. de juntas para motor		510800-R
	Junta tapa cilindros Ø 99 ±1.20	NFT	1 510807
	Junta tapa de válvulas	CG	1 510810
	Jgo. junta para cárter (4)	CG	1 220911-1
	Tapa distribución	NB	1 510912
	Tapa distribución	CB	1 220912
	Bomba de agua	CB	1 220914
	Múltiple admisión y escape	NFT	1 510816
	Salida agua	CB	1 220919
	Tapa bomba aceite	CB	1 510827
	Base bomba aceite	CB	1 220927
	Bomba nafta	CB	1 200028
	Cuerpo válvula cierre	GFT	1 510829
	Junta	CB	1 510830
	Junta anular 67 x 7.5 x 2.2	NB	510831
	Guarnición goma	GS	2 510832
	Cogotera	GS	1 510833
	Bancada	GS	1 510834
	Base distribuidor	CB	1 220938
	Arandela A 66.5 x 80	CB	1 510839
	O´ring G 63.09 x 3.53	GS	1
	Retén distribución 45 x 57 x 9.5	P	1 R510812P

CHRYSLER



Motor/Engine	Cm³	HP	Ø
258 AMC Jeep	4200	170	95.25

Chrysler: Wrangler - Jeep YJ 1986/90

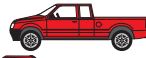

CHRYSLER / DODGE

Nº OE	Descripción/Description	Mat.	Ref.
	Jgo. de juntas para motor		510900-R
	Junta tapa cilindros Ø 99 ± 1.20	NFT	1 510907
	Junta tapa de válvulas	CG	1 510810
	Jgo. junta para cárter (4)	CG	1 220911-1
	Tapa distribución	NB	1 220912
	Tapa distribución 1986/...	CB	1 510912
	Tapa bomba de agua	CB	1 220914
	Múltiple admisión y escape	NFT	1 510816
	Salida agua	CB	1 220919
	Tapa bomba aceite	CB	1 510827
	Base bomba aceite	CB	1 220927
	Base bomba nafta	CB	1 200028
	Cuerpo válvula cierre	GFT	1 510829
	Junta	CB	1 510830
	Guarnición goma	GS	2 510832
	Junta anular 29 x 40 x 0.8	NB	510933
	Cogotera	GS	1 510833
	Bancada	GS	1 510834
	Base distribuidor	CB	1 220938
	Arandela A 28.5 x 40	CB	1 510838
	O´ring G 62 x 3.5	GS	1
	O´ring G 63.09 x 3.53	GS	1
	O´ring G 32.92 x 3.53	GS	1
	O´ring G 20.3 x 2.62	GS	2
	Retén distribución 45 x 57.15 x 9.5	P	1 R510812P



510907

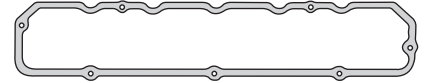

510810

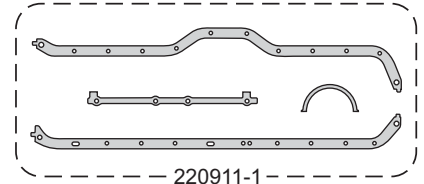

220911-1

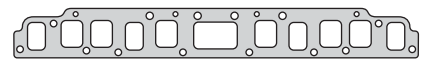

220914

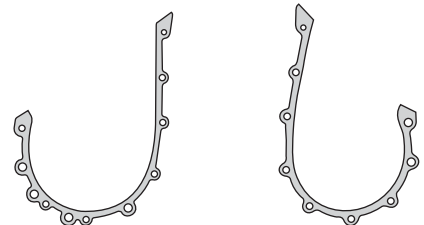

510827

220927



200028



220927



510829



220919



510827



510829



510830



510832



510933



G 62 x 3.5



G 63.09 x 3.53



220938



G 20.3 x 2.62



G 32.92 x 3.53



A 28.5 x 40



R510812P

CHRYSLER



Motor/Engine	Cm³	HP	Ø
239 CID V6	3910	130	99.31

Dodge: Pick Up V6 1987/91



Nº OE	Descripción/Description	Mat.	Ref.
	Jgo. de juntas para motor		● 520100-R
	Jgo. junta tapa cil. Ø 103 \pm 1.30 (2)	NFT	1 520107
	Junta tapa de válvulas	CG	2 520110
	Jgo. junta para cárter (4)	CG	1 520111
	Tapa distribución	CB	1 510512
	Bomba de agua	CB	1 520114
	Jgo. múltiple escape (2)	NFT	1 520115
	Jta. múltiple admisión	AC	1 520116
	Jgo. múltiple admisión (4)	AC	1 520117
	Termostato	CB	1 510519
	Junta	CB	1 520122
	Bomba combustible	CB	1 200028
	Junta unión múltiple	CG	1 520130
	Junta unión múltiple	CG	1 520131
	Junta porta retén A 104 x 118 x 1.6	CB	1 510533
	Arandela A 30 x 46 x 3	GS	1 510535
	Arandela A 13 x 23 x 1.5 C	CU	1
	Arandela A 14 x 18 x 1.5 A	AL	1
	O´ring G 23.52 x 1.78	GS	1
	O´ring G 27.5 x 3.53	GS	1
	O´ring G 44.04 x 3.53	GS	1
	O´ring G 67.95 x 2.62	GS	1
	Retén distribución 55 x 81 x 15.8	V	1 R510512V

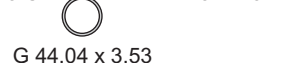
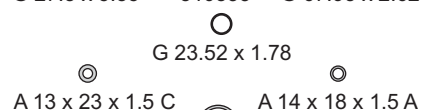
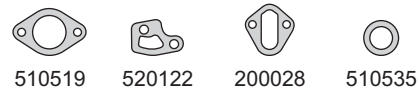
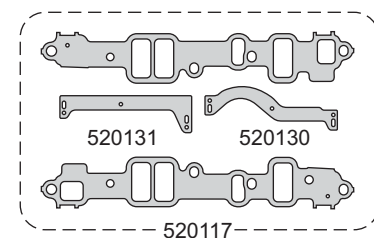
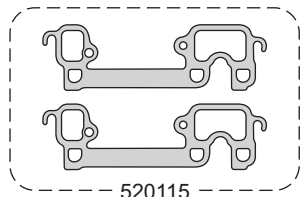
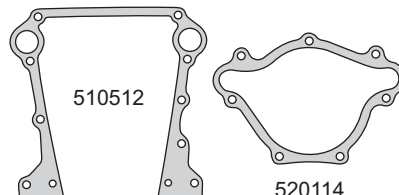
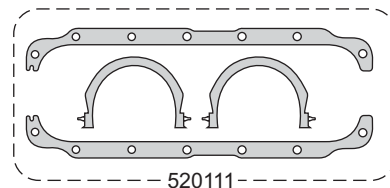
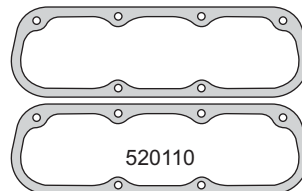
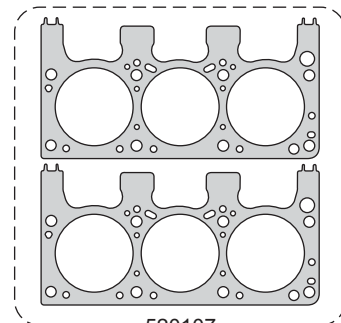

CHRYSLER



Motor/Engine	Cm³	HP	Ø
135 (EDR)	2213	177	87.5
EDM (K00)	2501	99/101	87.5
EDT	2501	150	87.5

Chrysler: 135 (EDR) Lebaron - Spirit - Shadow
 Voyager - Phantom - Caravan - Daytona
 New Yorker - Town & Country 1982/88
 EDM (K00) Caravan - Grand Caravan
 Grand Voyager - Saratoga 1986/95
 EDT Voyager - Caravan
 Lebaron - Daytona 1989/92

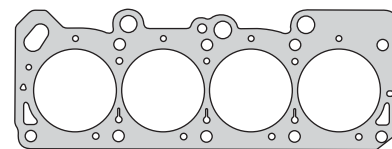

520205

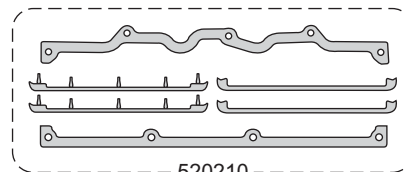

520210

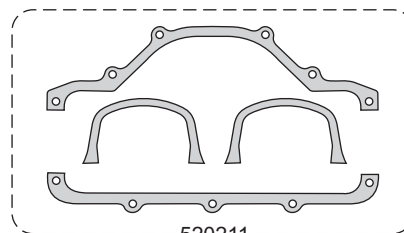

520211

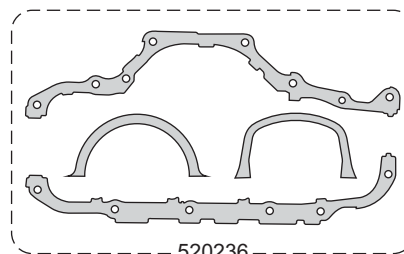

520236



520217

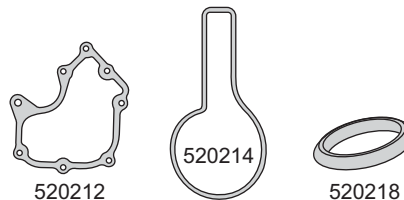

520212

520214

520218

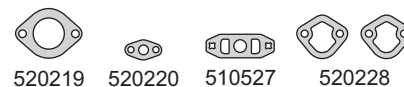

520219

520220

510527

520228

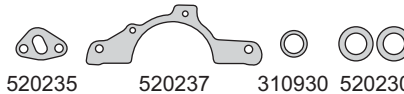

520235

520237

310930

520230



520238

520239

520240



G 6.07 x 1.78

G 20.3 x 2.62



G 17.12 x 2.62

G 47.22 x 3.53

G 21.89 x 2.62



R300051N



R330511V

R520212P

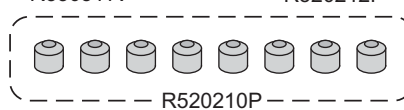

R520210P

Nº OE	Descripción/Description	Mat.	Ref.
	Jgo. de juntas para motor		520200-R
	Jgo. de juntas superior	●	520295
	Junta tapa cilindros Ø 89 ± 1.80	NFT 1 1	520205
	Junta tapa cilindros Ø 89 ± 1.90	NFT	520207
	Jgo. junta tapa válvulas (6)	CG 1 1	520210
	Jgo. junta para cárter (4) 1984/87	CG 1 1	520211
	Jgo. junta para cárter goma (4) 1986/93	GS 1 1	520236
	Junta frente	NB 1 1	520212
	Bomba de agua	GS 1 1	520214
	Múltiple admisión y escape	NFT 1 1	520217
	Salida eje	NB 1 1	520218
	Termostato	NB 1 1	520219
	Chupador aceite	NB 1 1	520220
	Junta bomba de aceite	NFT 1 1	510527
	Bomba de nafta	NB 2 2	520228
	Arandela drenaje de cárter	PL 1 1	310930
	Guarnición	GS 2 2	520230
	Guarnición	GS 1 1	520232
	Bomba de aceite	NB 1 1	520235
	Inferior frente	NB 1 1	520237
	Porta retén	NB 1 1	520238
	Árbol de levas	NB 1 1	520239
	Tapón árbol de levas	GS 1 1	520240
	Suplemento camisa cilindros (0.50)	AC	520285-0.50
	O´ring G 6.07 x 1.78	GS 1 1	
	O´ring G 17.12 x 2.62	GS 1 1	
	O´ring G 20.30 x 2.62	GS 1 1	
	O´ring G 21.89 x 2.62	GS 1 1	
	O´ring G 47.22 x 3.53	GS 1 1	
	Kit de retenes completo		R520200
	Jgo. retén válvulas (8)	P 1 1	R520210P
	Retén bancada 91 x 111 x 10	V 1 1	R330511V
	Retén árbol de levas 35 x 52 x 8	N 1 1	R520213N
	Retén árbol de levas auxiliar 35 x 52 x 8	P 3 3	R520212P
	Retén directa caja velocidad 28.58 x 41.2 x 6.2	N 1 1	R300051N

CHRYSLER / DODGE

CHRYSLER



Motor/Engine	Cm³	HP	Ø
360 c/ Carburador y T.B.I	5899		

Chrysler: Charger - Dart GTS - Le Baron
Cordoba - Monaco - Super Bee
Camiones Ligeros D350/D600
1979/92



Nº OE	Descripción/Description	Mat.	Ref.
	Jgo. de juntas para motor		520500-RMX
	Jgo. de juntas superior		520595 MX
	Jgo. junta tapa cilindro Ø 104 ± 1.20 (2)	NFT	1 1 520505
3658869	Conjunto tapa de válvulas (2)	CG	1 1 220510
	Jgo. junta para cárter (7)	CG	1 1 520511
	Tapa distribución	CB	1 1 510512
2129013	Tapa bomba de agua	NB	1 1 220514
	Jgo. múltiple escape (2)	NFT	1 1 520515
	Jgo. múltiple admisión (4)	NFT	1 1 520517
	Junta	NB	1 1 520519
	Junta	CB	1 1 520122
5752121	Bomba combustible	CB	1 1 200028
	Junta	GS	1 1 520530
2806095	Junta delantera múltiple admisión	CG	1 1 220530
2806096	Junta trasera múltiple admisión	CG	1 1 220531
	Jgo. múltiple admisión (4)	NB	1 1 520531
	Junta	AC	1 1 520532
	Junta porta retén	CB	1 1 510533
	Arandela A 14 x 20 x 1.5 C	CU	1 1
	Kit de retenes completo		R520500
	Jgo. retén válvulas (16)	P	1 1 R520510P
	Retén bancada (2 mitades)	S	2 1 R510711-1S
	Retén distribución 55 x 81 x 15.8	V	1 1 R510512V

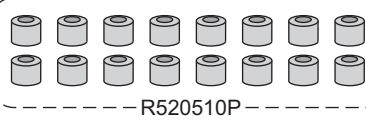
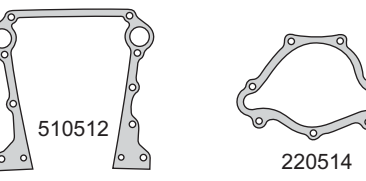
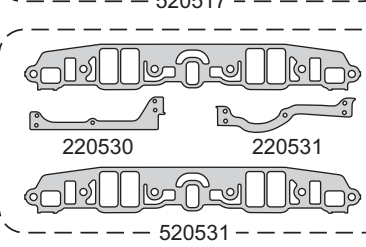
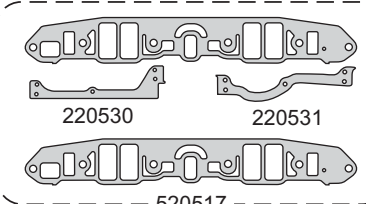
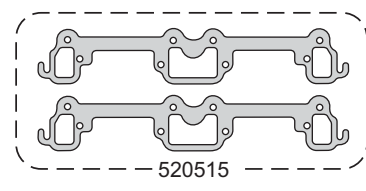
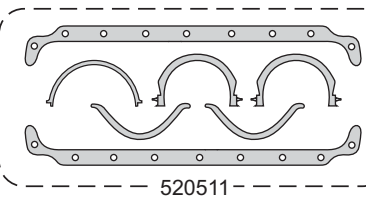
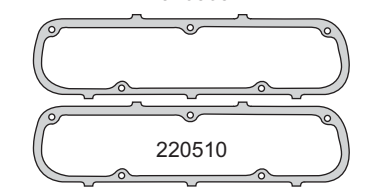
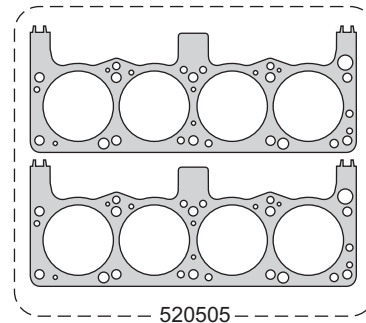

CHRYSLER / DODGE

CHRYSLER



Motor/Engine	Cm³	HP	Ø
150 (H00) (SOHC) V6 24V	2497	167	83.5

Chrysler: Stratus - Avenger - Sebring - Cirrus
1995/99



CHRYSLER / DODGE

Nº OE	Descripción/Description	Mat.	Ref.
MD973444	Jgo. de juntas para motor	●	520600-R
MD320044	Jgo. junta tapa cil. Ø 87 ± 1.40 (2)	NFT	2 520607
MD303148	Junta tapa válvulas	GS	2 960010
	Junta para cárter	CB	1 520611
	Jgo. múltiple escape (2)	FCH	1 960015
	Jgo. múltiple admisión (2)	AC	1 960017
	Anillo termostato	GS	1 520619
	Junta tapa VGR	NH	1 520626
	Junta entre colectores	AC	1 960029
	Junta brida VGR	NH	1 520632
	Junta brida VGR	NFT	1 520633
	Junta brida VGR	SLS	2 520634
	Junta brida VGR	AC	1 520635
	Junta brida VGR	NFT	1 520636
	Junta brida VGR	NFT	1 520637
	Guarnición cónica bujías G 24 x 37 x 42 x 1.6	GS	6 960038
	O´ring G 44.5 x 3.5	GS	1
	O´ring cañería agua G 16 x 3.5	GS	2
	O´ring pico inyector G 8 x 2	GS	6
	Kit de retenes completo		R960000
TRVSS0305980	Jgo. retén válvulas (24)	P	1 R960010P
TR4111209L	Retén bancada 91 x 111 x 9	S	1 R960011S
TRV0501306R	Retén distribución 37 x 50 x 6	N	1 R960012N
TRV0501508R	Retén árbol de levas 35 x 50 x 8	N	2 R960013N

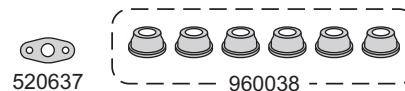
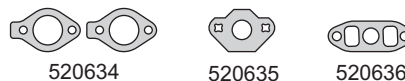
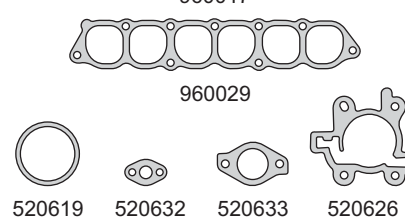
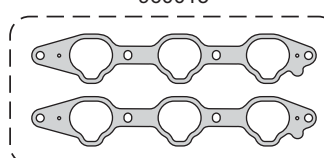
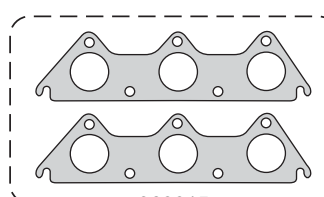
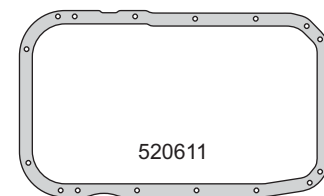
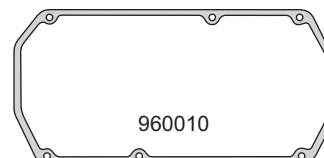
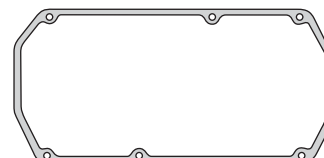
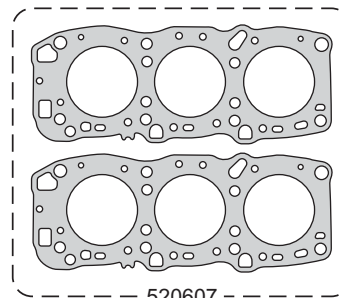

CHRYSLER



Motor/Engine	Cm³	HP	Ø
G54B	2555		

Chrysler: Pick Up - Lebaron - Caravan
1981/89



Nº OE	Descripción/Description	Mat.	Ref.
	Jgo. de juntas para motor		● 520800-RMX
	Jgo. junta tapa cilindros Ø 94 \pm 1.20	NFT	1 520805
	Junta tapa válvulas	GS	1 520810
	Junta para cárter	CG	1 910511
	Tapa distribución	CB	1 520812
	Tapa distribución	CB	1 520813
	Bomba de agua	NB	1 520814
	Múltiple escape	NFT	1 520816
	Múltiple admisión	NFT	1 520817
	Junta	NB	1 520819
	Junta	NB	2 520228
	Junta porta retén trasero	NB	1 910529
	Junta	NB	1 520830
	Junta frente motor	CB	1 520831
	Junta	NB	1 520832
	Junta	NB	1 520833
	Junta	NB	1 910433
	Junta	CB	1 520834
	Junta	NB	1 520835
	Guarnición	GS	2 520931
	O´ring G 17.12 x 2.62	GS	1
	Arandela A 18 x 22 x 1.5 A	AL	1
	Kit de retenes completo		R520800
	Jgo. retén válvulas (8)	P	1 R520810-1P
	Jgo. retén válvulas (4)	P	1 R520810-2P
	Retén bancada 80 x 96 x 9	S	1 R520811S
	Retén distribución 48 x 68 x 11	P	1 R520812P

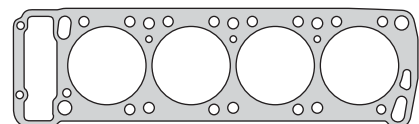

520805

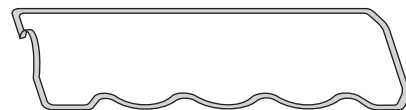

520810

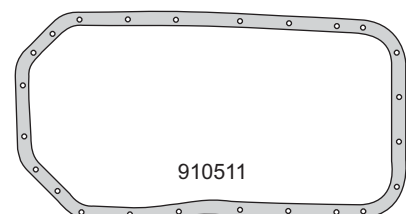

910511

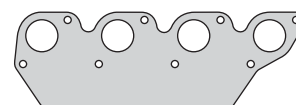

520816



520817



520812



520814



520813



520819



520228



520830

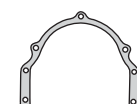

910529

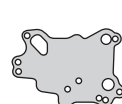

520833



520831



520832



A 18 x 22 x 1.5 A



910433

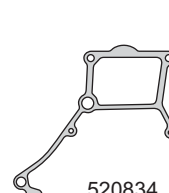

520834

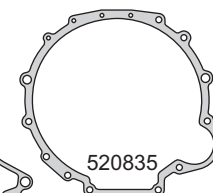

520835



G 17.12 x 2.62



R520811S



R520812P

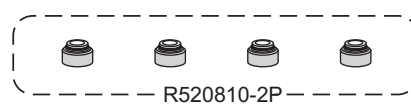

R520810-2P



R520810-1P

CHRYSLER



Motor/Engine	Cm³	HP	Ø
181 V6	3000		

Chrysler: Pick Up 1987/96

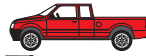

CHRYSLER / DODGE

Nº OE	Descripción/Description	Mat.	Ref.
	Jgo. de juntas para motor		520900-RMX
	Jgo. de juntas superior	●	520995
	Jgo. jta. tapa cilin. Ø 95 ± 1.50 (2)	NFT 1	520905
	Jgo. jta. tapa cilin. Ø 95 ± 1.60 (2)	NFT 1	520907
	Conj. junta tapa de válvulas (2)	GS 1	520910
	Junta para cárter	CB 1	520611
	Junta distribución	CB 1	520912
	Junta distribución	CB 1	520913
	Junta distribución	CB 1	961113
	Bomba de agua	CB 1	520914
	Bomba de agua	CB 1	520914-1
	Jgo. múltiple escape (2)	AC 1	520915
	Jgo. múltiple admisión (2)	NFT 1	520917
	Salida de escape	NFT 2	520918
	Junta	CB 1	520919
	Junta árbol de levas	CB 1	510020
	Junta	NB 2	520228
	Guarnición	NB 2	520930
	Guarnición	GS 4	520931
	Junta	CB 2	520932
	Junta	CB 1	520933
	Junta	CB 1	520934
	Junta	CB 1	520935
	Junta	CB 1	520936
	Junta	NFT 1	520937
	Jgo. múltiple de admisión (2)	CB 1	520938
	Junta	CB 1	520939
	Junta	CB 1	520940
	Junta	CB 1	520941
	Junta	CB 1	520942
	Junta	NFT 2	520943
	Junta	CB 2	520944
	O´ring G 7.65 x 1.78	GS 12	12
	O´ring G 9.25 x 1.78	GS 2	2
	O´ring G 45.69 x 2.62	GS 1	1
	O´ring G 15.47 x 3.53	GS 1	1
	O´ring G 21.82 x 3.53	GS 1	1
	O´ring G 31.34 x 3.53	GS 3	3
	Arandela A 19 x 26 x 1.5 C	CU 1	
	Arandela A 20 x 28 x 1 C	CU 1	
	Kit de retenes completo		R520900
	Jgo. retén válvulas (12)	P 1	R520910P
	Retén bancada 91 x 111 x 9	S 1	R520911S
	Retén distribución 37 x 50 x 6	S 1	R520912S
	Retén auxiliar 35 x 50 x 8	N 2	R520915N

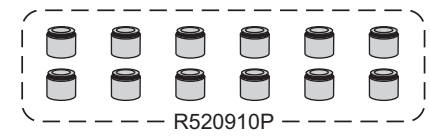
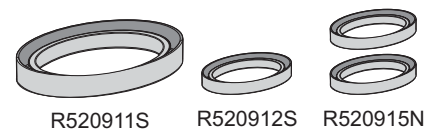
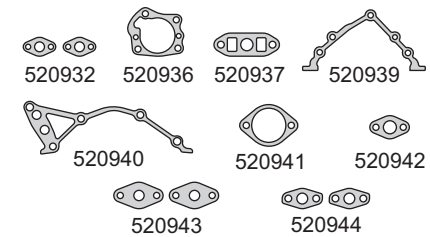
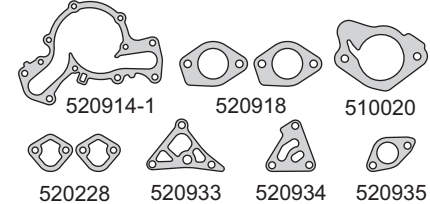
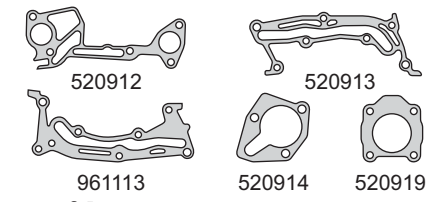
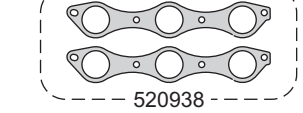
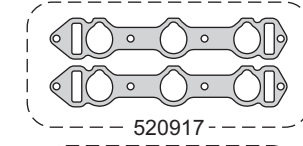
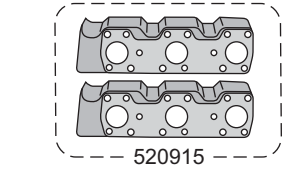
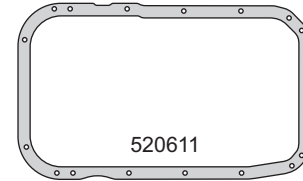
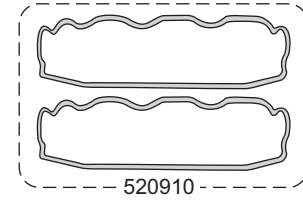
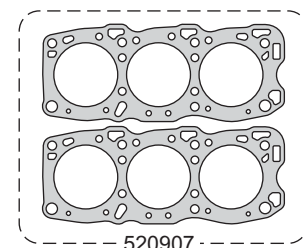

CHRYSLER



Motor/Engine **(SOHC) 16V** **1996** **135** **87.5**

Chrysler: Neón 2000/05



Nº OE	Descripción/Description	Mat.	Ref.
	Jgo. de juntas para motor		521000-R
0477-7072AB	Junta tapa cilindros Ø 89.5 ± 1.00	MLS	1 521008
0466-7985	Conj. junta tapa de válvulas (5)	GS	1 521010
0455-6666	Junta para cárter (goma/metal)	GS	1 230411
0466-7663	Bomba de agua	GS	1 230414
0466-7492	Múltiple escape	NFT	1 230416
0477-7895AA	Junta toberas múltiple admisión (4)	GS	1 230417
	Brida	NFT	1 230439
	Brida	NFT	1 230440
	Guarnición goma G 24 x 32 x 4.5	GS	1 230442
	O'ring G 48.9 x 2.62	GS	1
	O'ring G 35 x 6	GS	1
	O'ring G 34.52 x 3.53	GS	1
	O'ring G 20.3 x 2.62	GS	1
	O'ring G 26.64 x 2.62	GS	1
	Kit de retenes completo		R521000
	Jgo. retén válvulas (16)	P	1 R521010P
0466-7904	Retén bancada 91 x 111 x 10	V	1 R330511V
0466-7198	Retén distribución 32 x 45 x 6.5	P	1 R230412P
0477-7086	Retén árbol de levas 35 x 48 x 7	P	1 R240013P

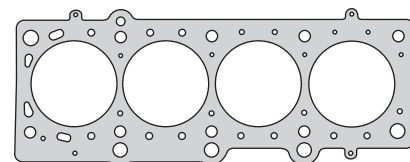

521008

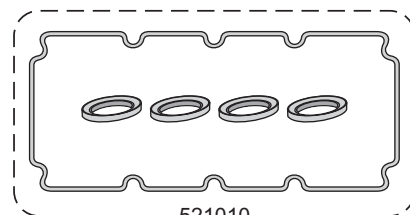

521010

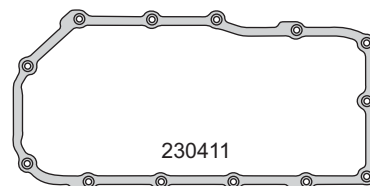

230411



230416



230417



230414



230439



230440



230442



G 26.64 x 2.62

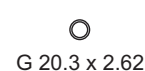

G 20.3 x 2.62



G 34.52 x 3.53



G 48.9 x 2.62



G 35 x 6



R330511V



R230412P



R240013P

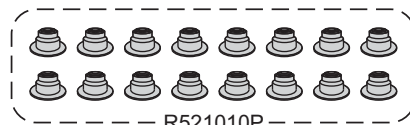

R521010P

CHRYSLER / DODGE

CHRYSLER



Motor/Engine	Cm³	HP	Ø
ECC	1996	150	87.5

Chrysler: PT Crusier 2002/05



CHRYSLER / DODGE

Nº OE	Descripción/Description	Mat.		Ref.
	Jgo. de juntas para motor		●	521100-R MLS
	Jgo. de juntas superior		●	521195
	Juntas tapa cilindro Ø 88 \pm 0.70	NFT	1	521108
	Conj. junta tapa de válvulas (5)	GS	1	521110
0455-6666	Junta para cárter (goma/metal)	GS/AC	1	230411
0466-7663	Bomba de agua	GS	1	230414
	Múltiple escape	AC	1	521515
	Jgo. múltiple admisión (4)	GS	1	521117
	Jgo. múltiple admisión (4)	GS	1	521132
	Brida	NFT	1	230439
	Brida	NFT	1	230440
	Guarnición goma G 24 x 32 x 4.5	GS	1	230442
	Arandela A 20 x 28 x 1 C	CU	1	
	O´ring G 7.52 x 3.53	GS	4	4
	O´ring G 20.3 x 2.62	GS		1
	O´ring G 26.64 x 2.62	GS		1
	O´ring G 36.09 x 3.53	GS		1
	O´ring G 37.77 x 2.62	GS		1
	O´ring G 48.9 x 2.62	GS		1
	Kit de retenes completo			R521000
	Jgo. retén válvulas (16)	P	1	R521010P
0466-7904	Retén bancada 91 x 111 x 10	V	1	R330511V
0466-7198	Retén distribución 32 x 45 x 6.5	P	1	R230412P
0477-7086	Retén árbol de levas 35 x 48 x 7	P	2	R240013P

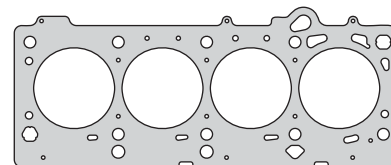

521108

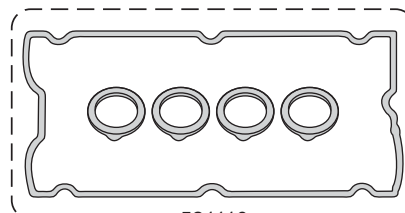

521110

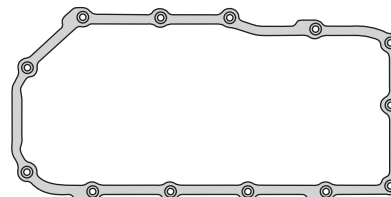

230411

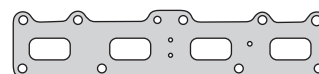

521515



521117

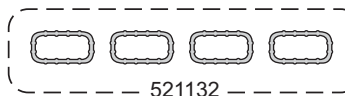

521132



230414



230439



230440



230442

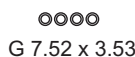

G 7.52 x 3.53



G 20.3 x 2.62



G 37.77 x 2.62



G 36.09 x 3.53



A 20 x 28 x 1 C



G 48.9 x 2.62



G 26.64 x 2.62



R330511V



R230412P



R240013P

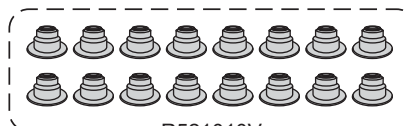

R521010V

CHRYSLER



Motor/Engine	Cm³	HP	Ø
135 (EDR)	2213	177	87.5
153 (EDT)	2501	150	87.5

Chrysler: Voyager - Caravan - Saratoga
Lebaron - Daytona Turbo 1989/...



Nº OE	Descripción/Description	Mat.	Ref.
	Jgo. de juntas para motor		521200-R
	Jgo. de juntas superior		521295
	Jgo. juntas tapa cilindro Ø 89 ± 1.80	NFT 1 1	520205
	Junta tapa de válvulas	GS 1 1	521210
	Jgo. junta para cárter (4)	CG 1 1	520211
	Tapa distribución	NB 1 1	520212
	Bomba de agua	GS 1 1	520214
	Múltiple admisión	NFT 1 1	520217
	Salida eje	NB 1 1	520218
	Termostato	NB 1 1	520219
	Chupador aceite	NB 1 1	520220
	Junta bomba de aceite	NFT 1 1	510527
	Bomba de nafta	NB 2 2	520228
	Guarnición	GS 2 2	520230
	Arandela drenaje de cárter	PLAST 1 1	310930
	Guarnición	GS 1 1	520232
	Bomba de aceite	NB 1 1	520235
	Jgo. junta para cárter (4)	GS 1 1	520236
	Inferior frente	NB 1 1	520237
	Porta retén	NB 1 1	520238
	Arbol de levas	NB 1 1	520239
	Tapón árbol de levas	GS 1 1	520240
	O´ring G 6.07 x 1.78	GS 1 1	
	O´ring G 17.12 x 2.62	GS 1 1	
	O´ring G 20.30 x 2.62	GS 1 1	
	O´ring G 21.89 x 2.62	GS 1 1	
	O´ring G 47.22 x 3.53	GS 1 1	
	Kit de retenes completo		R520200
	Jgo. retén válvulas (8)	P 1 1	R520210P
	Retén bancada 91 x 111 x 10	V 1 1	R330511V
	Retén auxiliar 35 x 52 x 8	P 3 3	R520212P
	Retén directa caja velocidad 28.58 x 41.2 x 6.2	N 1 1	R300051N

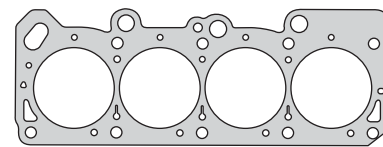

520205



521210

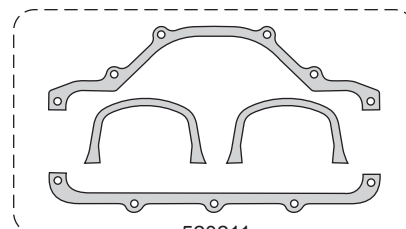

520211

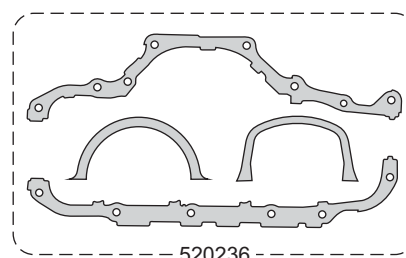

520236

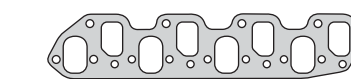

520217

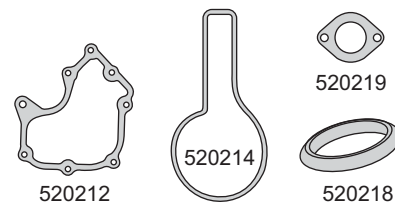

520212 520214 520218 520219



520220 510527 520228 520230

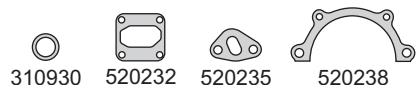

310930 520232 520235 520238

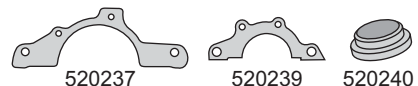

520237 520239 520240



G 6.07 x 1.78 G 20.3 x 2.62



G 17.12 x 2.62 G 47.22 x 3.53 G 21.89 x 2.62



R300051N



R330511V R520212P

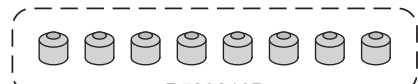

R520210P

CHRYSLER / DODGE

CHRYSLER



Motor/Engine	Cm³	HP	Ø
EDZ	2429	150	87.5

Chrysler: Stratus - Cirrus - Plymouth Breeze
Caravan - Grand Caravan - Voyager
Grand Voyager 1995/00



CHRYSLER / DODGE

Nº OE	Descripción/Description	Mat.	Ref.
	Jgo. de juntas para motor		521400-R
	Jgo. de juntas superior	●	521495
0469-4324	Junta tapa cilindros Ø 89 \pm 1.40	NFT	1 1 230807
	Conj. junta tapa de válvulas (5)	GS	1 1 521410
	Jgo. junta para cárter (14)	CG	1 1 521411
0466-7663	Bomba de agua	GS	1 1 230414
0466-7722	Múltiple escape	NFT	1 1 230816
0466-7539	Múltiple admisión	NB	1 1 230817
	Junta	NB	1 1 230832
	Arandela A 20 x 28 x 1 C	CU	1
	O´ring G 20.3 x 2.62	GS	1
	O´ring G 24.99 x 3.53	GS	1
	Kit de retenes completo		R521400
0464-8619	Jgo. retén válvulas (16)	P	1 R521010P
	Retén bancada 91 x 111 x 10	V	1 R981311V
0466-7198	Retén distribución 32 x 45 x 6.5	P	1 R230412P
0477-7086	Retén árbol de levas 38 x 48 x 7	P	2 R240013P

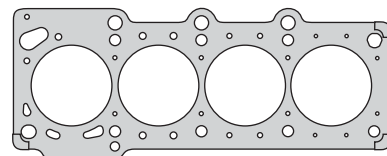

230807

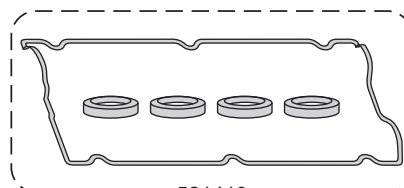

521410

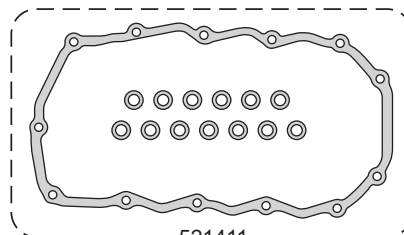

521411



230816

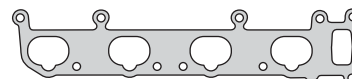

230817

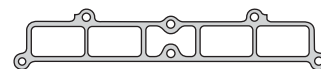

230832



230414



A 20 x 28 x 1 C



G 20.3 x 2.62



G 24.99 x 3.53



R981311V



R230412P



R240013P

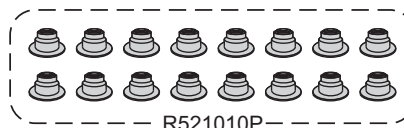

R521010P

CHRYSLER



Motor/Engine	Cm³	HP	Ø
EDZ	2429	150	87.5

Chrysler: Stratus 2002/6



Nº OE	Descripción/Description	Mat.	Ref.
	Jgo. de juntas para motor		521500-R
	Juntas tapa cilindro Ø 88 ± 0.70	NFT	1 521108
	Conj. junta tapa de válvulas (5)	GS	1 521510
	Junta para cárter	GS	1 521511
	Bomba de agua	GS	1 521514
	Múltiple escape	AC	1 521515
	Jgo. múltiple admisión (4)	GS	1 521517
	Junta	GS	1 521530
	Brida	NFT	1 230440
	Guarnición goma G 24 x 32 x 4.5	GS	1 230442
	Arandela A 20 x 28 x 1 C	CU	1
	O'ring G 7.52 x 3.53	GS	4
	O'ring G 15.47 x 3.53	GS	2
	O'ring G 20.3 x 2.62	GS	1
	O'ring G 26.64 x 2.62	GS	1
	O'ring G 36.09 x 3.53	GS	1
	O'ring G 37.77 x 2.62	GS	1
	O'ring G 48.9 x 2.62	GS	1
	Kit de retenes completo		R521500
	Jgo. retén válvulas (16)	P	1 R521010P
0466-7904	Retén bancada 91 x 111 x 10	V	1 R330511V
0477-7086	Retén árbol de levas 35 x 48 x 7	P	2 R240013P

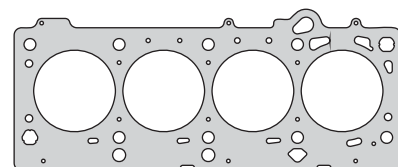

521108

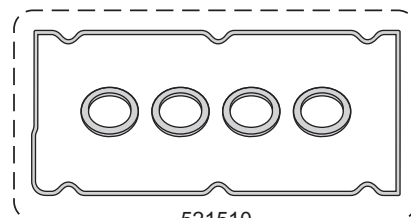

521510

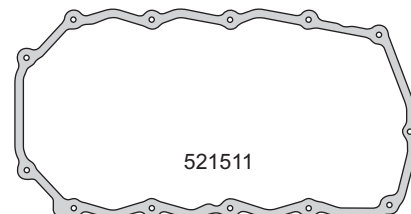

521511

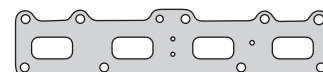

521515

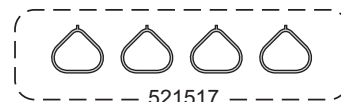

521517

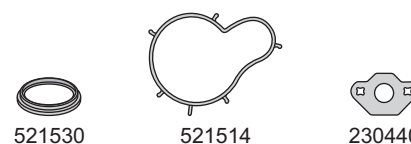

521530

521514

230440

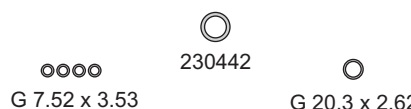

G 7.52 x 3.53

230442

G 20.3 x 2.62



G 36.09 x 3.53

G 37.77 x 2.62

A 20 x 28 x 1 C

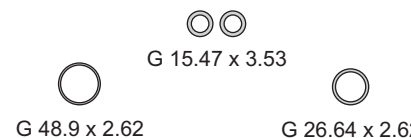

G 48.9 x 2.62

G 15.47 x 3.53

G 26.64 x 2.62



R330511V

R240013P



R521010P

CHRYSLER



Motor/Engine	Cm³	HP	Ø
EGH	3778	162	96

Chrysler: Voyager 2002/06
Pacifica 2004/07



CHRYSLER / DODGE

Nº OE	Descripción/Description	Mat.	Ref.
	Jgo. de juntas para motor		521600-R
	Jgo. de juntas superior	●	521695
	Jgo. tapa cilin. Ø 97.2 ± 0.75 (2) NR	MLS 1 1	521608
	Jgo. tornillos tapa cilindros (HAS15038)		B510000
	Junta tapa de válvulas	GS 2 2	521610
	Junta para cárter	GS 1	510011
	Tapa distribución	CB 1	510012
	Jgo. múltiple escape (2)	NFT 1 1	510015
	Múltiple admisión	SLS 1 1	521617
	Junta	NB 1	521619
	Junta bancada trasera	CB 1	510122
	Junta	AC 2 2	521630
	Junta	GS 1	521631
	Jgo. múltiple de admisión (8)	VS 1 1	521632
	Junta cuerpo aceleración	S 1 1	521633
	Guarnición goma	GS 1	521634
	Junta	NB 1	521635
	O´ring G 20.32 x 2.62	GS 1	
	Kit de retenes completo		R521600
	Jgo. reten válvulas (16)	V 1	R521610V
	Retén bancada 91 x 111 x 10	V 1	R330511V
	Retén distribución 28.5 x 41.25 x 6	P 1	R510012P

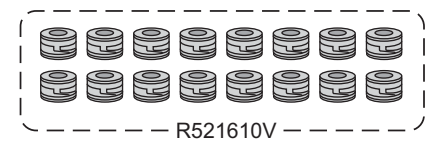
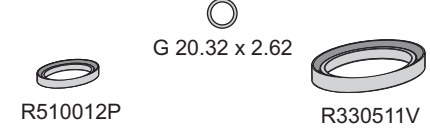
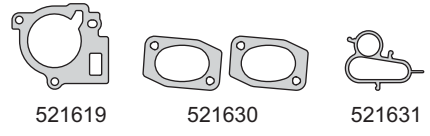
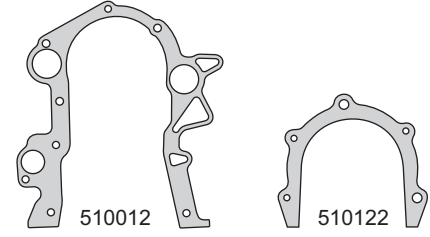
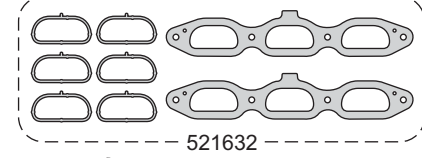
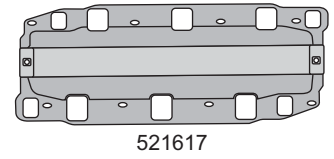
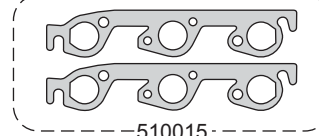
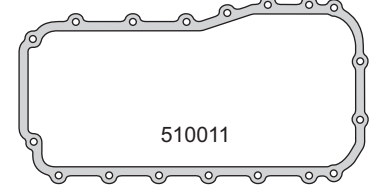
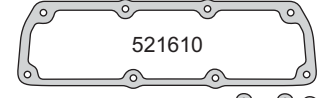
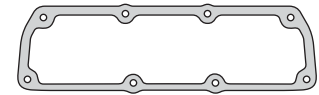
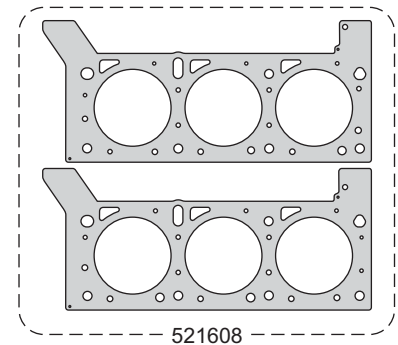

CHRYSLER



Motor/Engine	Cm³	HP	Ø
V8 Magnum	4698	235	93

Chrysler: Dakota - Ram 1500 2000/11
Grand Cherokee - Durango 1999/09
Aspen - Commander 2006/09



Nº OE	Descripción/Description	Mat.	Ref.
	Jgo. de juntas para motor		521700-R
	Jgo. de juntas superior	●	521795
	Jgo. jta. tapa cil. Ø93.7 ± 0.75 (2) N.R.	MLS 1 1	521708
	Conj. junta tapa válvulas (2)	GS 1 1	521710
	Junta para cárter	AC/GS 1	521711
	Tapa distribución	AC/GS 1	521712
	Jgo. múltiple escape (2)	GFT 1 1	521715
	Jgo. múltiple admisión (8)	GS 1 1	521717
	Bomba de agua	GS 1 1	521730
	Junta cuerpo aceleración	GS 1	521731
	Junta tubo de llenado de aceite	GS 1 1	521732
	Junta	GS 1 1	521733
	Junta	GS 1 1	521734
	Kit de retenes completo		R521700
	Jgo. retén válvulas (16)	V 1	R521710V
	Retén bancada 91 x 111 x 10	V 1	R521711V
	Retén distribución 32 x 45 x 6	V 1	R521712V

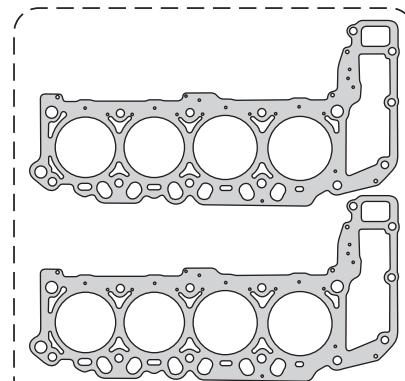

521708

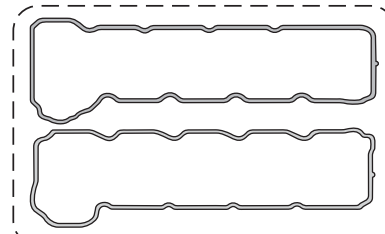

521710

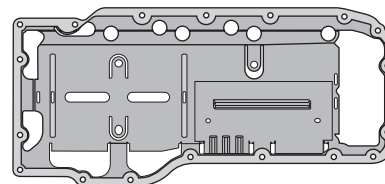

521711

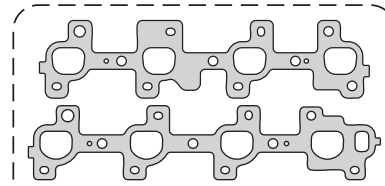

521715

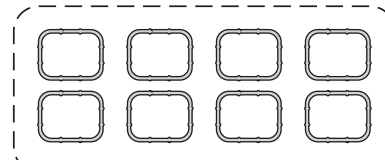

521717

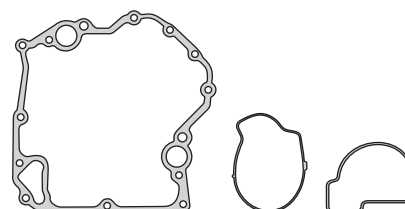

521712

521730

521731



521732

521733

521734

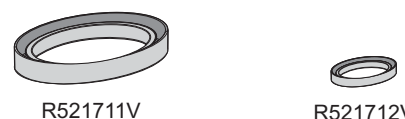

R521711V

R521712V

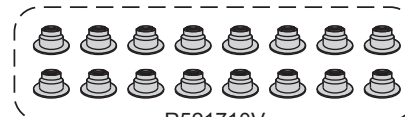

R521710V

CHRYSLER



Motor/Engine	Cm³	HP	Ø
EKG V6 (SOHC) 12V	3701	210	93

Chrysler: Dakota - Ram 1500 - Durango 2000/09
Jeep: Liberty - Grand Cherokee 2002/09



CHRYSLER / DODGE

Nº OE	Descripción/Description	Mat.	Ref.
	Jgo. de juntas para motor		521800-R
	Jgo. de juntas superior	●	521895
	Jgo. tapa cil. Ø 93.75 ± 0.70 (2)	NFT 1 1	521808
	Conj. junta tapa de válvulas (2)	GS 1 1	521810
	Junta para cárter	AC/GS	521811
	Junta distribución	AC/GS	521812
	Jgo. múltiple escape (2)	GFT 1 1	521815
	Jgo. múltiple admisión (6)	GS 1 1	521817
	Bomba de agua	GS 1 1	521830
	Junta cuerpo aceleración	GS 1 1	521731
	Junta cuerpo aceleración	GS 1	521831
	Junta tubo llenado de aceite	GS 1 1	521732
	Junta	GS 1	521733
	Junta	GS 1	521734
	Kit de retenes completo		R521800
	Jgo. retén válvulas (12)	V 1	R521810V
	Retén bancada 91 x 111 x 10	V 1	R521711V
	Retén distribución 32 x 45 x 6	V 1	R521712V

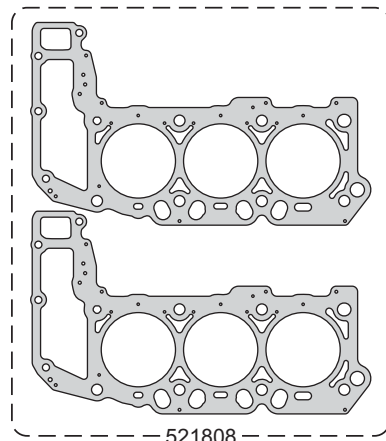

521808

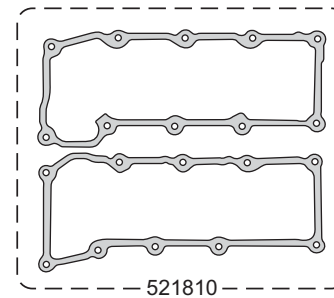

521810

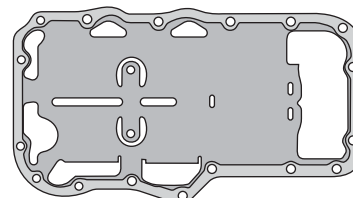

521811

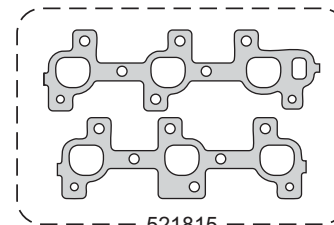

521815

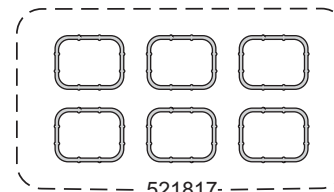

521817



521812 521731 521732 521830



521831 521733 521734



R521711V R521712V



R521810V

CHRYSLER



Motor/Engine	Cm³	HP	Ø
Hemi V8	5645	345	99.5

Chrysler: Ram 2500 - Ram 3500 - Ram Quad
Charger - Jeep Comander - Sonora
300C - Grand Cherokee - Aspen



Nº OE	Descripción/Description	Mat.	Ref.
	Jgo. de juntas para motor		● 521900-RMX
	Jgo. juntas tapa cil. Ø 100 ± 0.75 (2)	MLS	1 521908
	Conj. junta tapa de válvulas (10)	GS	1 521910
	Junta para cárter	AC/GS	521911
	Junta distribución	GS	1 521912
	Jgo. múltiple escape (2)	NFT	1 521915
	Jgo. múltiple admisión (8)	GS	1 521917
	Junta válvula PVC	GS	1 521930
	Guarnición goma	GS	1 521931
	Junta cuerpo de aceleración	GS	1 521932
	Kit de retenes completo		R521900
	Jgo. retén válvulas (16)	V	1 R521910V
	Porta retén bancada	V	PR521911V
	Reten distribución 50 x 75.5 x 11	T	R521912T

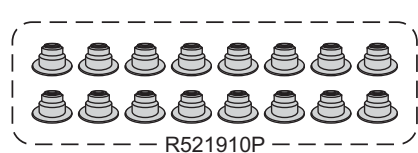
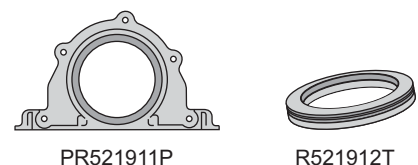
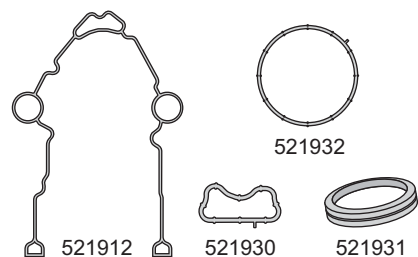
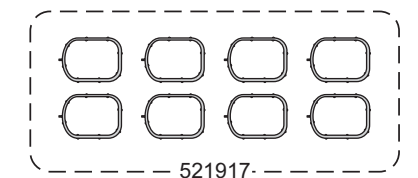
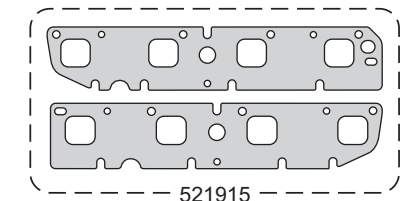
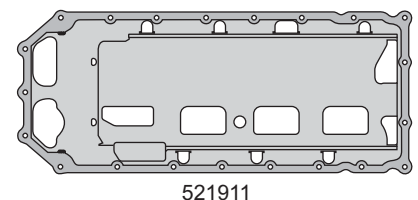
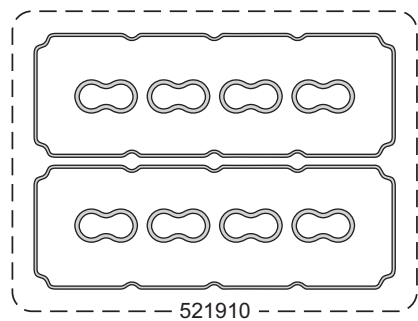
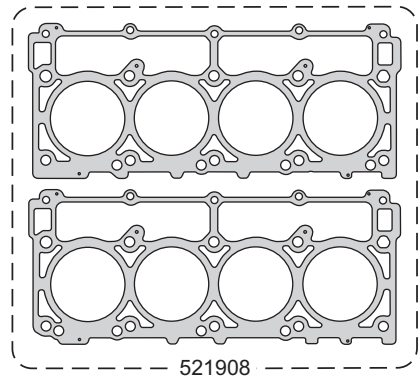

CHRYSLER / DODGE

CHRYSLER



Motor/Engine	Cm³	HP	Ø
EGE	3518	214	96

Chrysler: Concorde - New Yorker LHS



CHRYSLER / DODGE

Nº OE	Descripción/Description	Mat.	Ref.
	Jgo. de juntas para motor		522000-R
	Jgo. de juntas superior	●	522095
	Jgo. tapa cilin. Ø 100 ± 1.40 (2)	NFT 1 1	522007
	Junta tapa válvulas	GS 2 2	522010
	Junta para cárter	ACP	522011
	Junta distribución	NB 1 1	522012
	Jgo. múltiple escape (2)	NFT 1 1	522015
	Jgo. múltiple admisión (2)	NB 1 1	522017
	Junta base termostato	NB 1 1	200819
	Junta	CB 1 1	510122
	Arandela drenaje cárter		310930
	Junta	NB 2 2	522030
	Junta	NB 2 2	522031
	Junta	NB 1 1	522032
	Junta	GFT 1 1	520637
	Junta brida	NFT 1 1	230439
	Junta brida	NFT 1 1	230440
	Junta	GFT 1 1	520640
	O´ring G 20.3 x 2.62	GS 8 8	
	O´ring G 24 x 30 x 3.9	GS 1 1	
	O´ring G 28.17 x 3.53	GS 6 6	
	O´ring G 34.52 x 3.53	GS 2 2	
	O´ring G 7.52 x 3.53	GS 6 6	
	O´ring G 98.02 x 3.53	GS 1 1	
	Kit de retenes completo		R522000
	Jgo. retén válvulas (24)	P 1	R522010P
	Retén bancada 91 x 111 x 10	V 1	R330511V
	Retén árbol de levas	P 1	R522013P
	Retén directa caja velocidad 28.58 x 41.20 x 6.2	N 1	R300051N

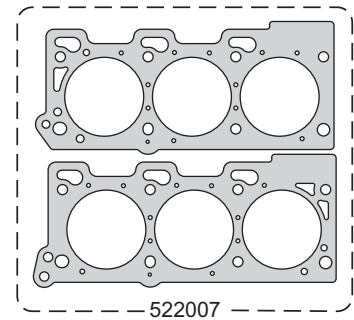

522007

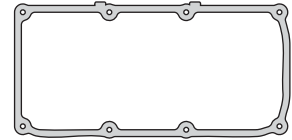

522010

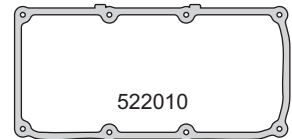

522011

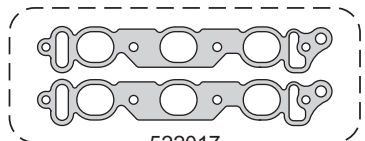
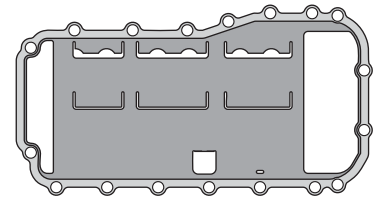

522017

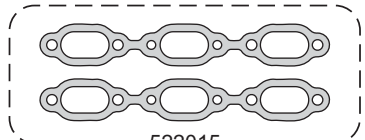

522015

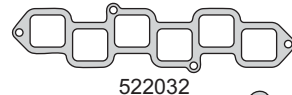

522032

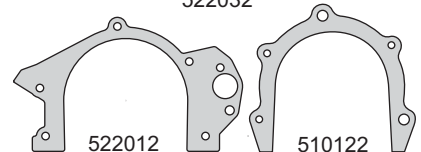

522012

510122

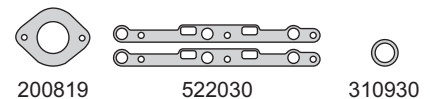

200819

522030

310930



522031

520637

230439



520640

230440



R330511V

R522013P

R300051N

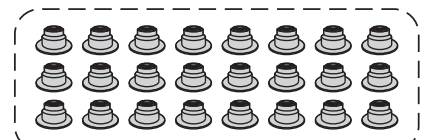

R522010P

CHRYSLER



Motor/Engine	Cm³	HP	Ø
EDZ	2429	150	87.5

Chrysler: PT Crusier 2002/05



Nº OE	Descripción/Description	Mat.	Ref.
	Jgo. de juntas para motor		522100-R
	Jgo. de juntas superior		522195
	Jta. tapa cilindro Ø 88 ± 0.70	NFT	1 1 521108
	Conj. junta tapa de válvulas (5)	GS	1 1 521110
	Junta para cárter	GS	1 1 522111
0466-7663	Bomba de agua	GS	1 1 230414
	Junta múltiple escape	AC	1 1 521515
	Jgo. múltiple admisión (4)	GS	1 1 521117
	Junta	AL/GS	1 1 522130
	Jgo. múltiple admisión (4)	GS	1 1 521132
	Brida	NFT	1 1 230439
	Brida	NFT	1 1 230440
	Guarnición goma G 24 x 32 x 4.5	GS	1 1 230442
	Arandela A 20 x 28 x 1 C	CU	1
	O'ring G 7.52 x 3.53	GS	4 4
	O'ring G 15.47 x 3.53	GS	2
	O'ring G 20.3 x 2.62	GS	1
	O'ring G 26.64 x 2.62	GS	1
	O'ring G 36.09 x 3.53	GS	1
	O'ring G 37.77 x 2.62	GS	1
	O'ring G 48.9 x 2.62	GS	1
	Kit de retenes completo		R522100
	Jgo. retén válvulas (16)	P	1 R521010P
0466-7904	Retén bancada 91 x 111 x 10	V	1 R330511V
0466-7198	Retén distribución 32 x 45 x 6.5	P	1 R230412P
0477-7086	Retén árbol de levas 35 x 48 x 7	P	2 R240013P

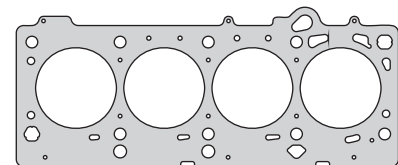

521108

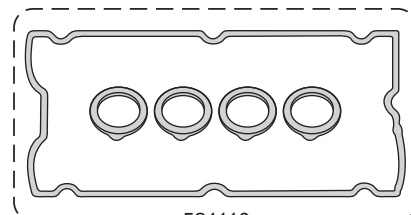

521110

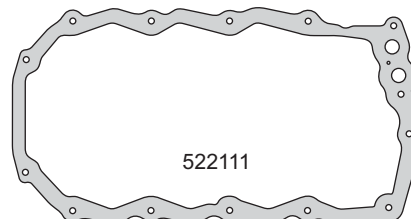

522111

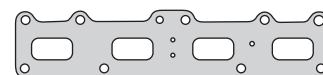

521515



521117

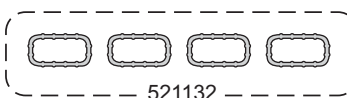

521132

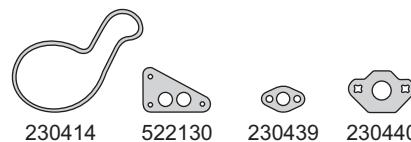

230414 522130 230439 230440

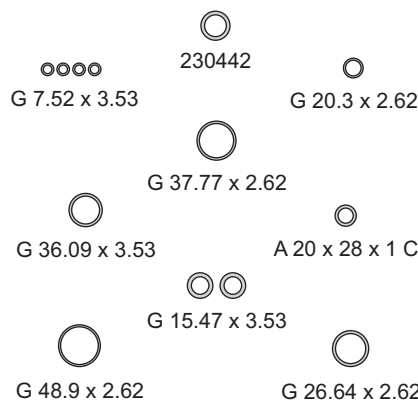

230442
G 7.52 x 3.53 G 20.3 x 2.62
G 37.77 x 2.62
G 36.09 x 3.53 A 20 x 28 x 1 C
G 15.47 x 3.53
G 48.9 x 2.62 G 26.64 x 2.62



R330511V



R230412P



R240013P

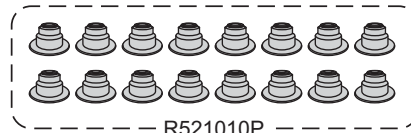

R521010P

CHRYSLER



Motor/Engine	Cm³	HP	Ø
ED3 - GEMA (DOHC) 16V	2360	170/174	88

Chrysler: Jeep - Avenger - Patriot - Caliber
Compass - Sebring - Stratus 2007/...
Journey - Compass 2009/...
Fiat: Freemont 2012/...

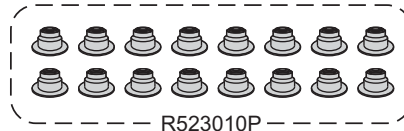
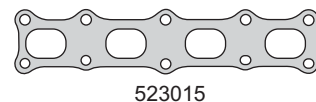
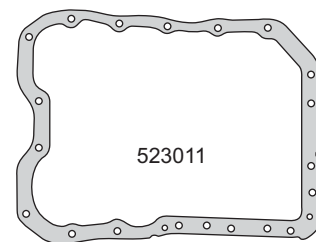
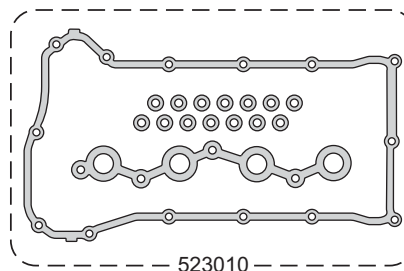
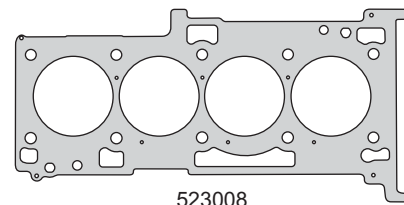

CHRYSLER / DODGE

N° OE	Descripción/Description	Mat.	Ref.
05189956AA	Jgo. de juntas para motor	●	523000-R MLS
04884762A	Junta tapa cilindros Ø 89 ± 0.50	NFT	1 523008
	Sellador líquido - caucho de silicona		TRN0280R
	Conj. junta tapa válvulas (17)	GS	1 523010
	Junta para cárter	CG	1 523011
04693346AB	Múltiple escape	AC	1 523015
04884883AA	Múltiple admisión	GS	1 523017
04884696AA	Salida bomba de agua	SLS	1 503027
04884703AA	Entrada de agua	SLS	1 523019
04884551AA	Junta cuerpo acelerador	GS	1 523031
1028A025	Filtro		1 523038
04884572AA	Adaptador salida de refrigerante	GS	1 523037
04884873AA	O´ring tubo entrada de agua G 32 x 4.3	GS	1
	O´ring G 8.5 x 1.9	GS	1
	Kit de retenes completo		R523000
2222425000	Jgo. retén válvulas (16)	P	1 R523010P
05047167AA	Retén bancada 85 x 103 x 8	V	1 R523011V
05047372AA	Retén distribucion 42 x 55 x 7	P	1 R523012P

DI TELLA



Motor/Engine	Cm³	HP	Ø
	1489		73.02
	1622		76.20

Di Tella: Morris - Riley - Traveller 1500 - Pick Up
 Argenta 1500 - Magnette 1622
 Morris 1650 - Magnette 1960/66



N° OE	Descripción/Description	Mat.	Ref.
48G 131	Jgo. de juntas para motor		210900
137541	Junta tapa cilindros Ø 80.4 ± 1.40	NFT	1 210905
137561	Junta tapa válvulas	CG	1 210910
137118	Jgo. junta para cárter (3)	CG	1 210911
137004	Tapa distribución	CG	1 210912
137044	Placa distribución	CB	1 210913
139516	Bomba de agua	NB	1 210914
140006	Múltiple admisión y escape	NFT	1 210916
	Entre múltiples	NFT	1 210917
137543	Codo base termostato	CB	1 210919
	Jgo. juntas carburador	VS	210920
	Base carburador	NB	1 210925
139007	Bomba aceite a block	NB	1 210927
	Base bomba nafta	NB	1 210928
139005	Bomba aceite a filtro	NB	1 210931
137544	Brida chica calef. block	NB	2 210932
	Brida grande calef. block	NB	1 210933
137014	Placa trasera distribución	CB	1 210934
138014	Tensor porta cadena	NB	1 210935
137053	Lateral tapa válvulas	CG	2 210936
137042	Arandela tapón cárter A 22 x 27 x 1 C	CU	1 210938
137093	Arandela bomba aceite A 13 x 18 x 1 C	CU	1 210939
120566	Palier	CB	210957
120552	Tapa diferencial	CG	210959
	Junta bancada cárter	CG	2 210980
	Jgo. retén válvulas (8)	P	R220110P
	Retén distribución 39.68 x 58.73 x 9.46	N	R210912N

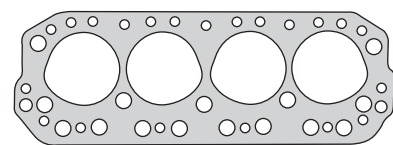

210905

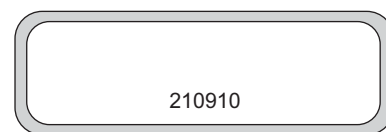

210910

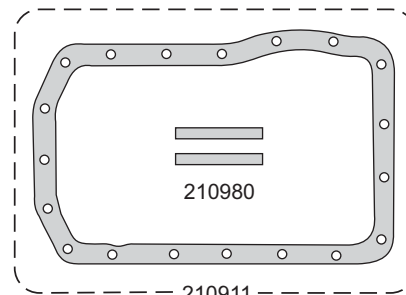

210911



210936



210916

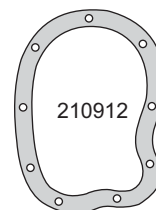

210912

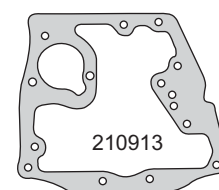

210913



210914



210917



210919



210925



210927



210928



210931

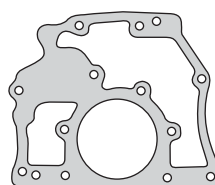

210934



210932



210933



210935



A 22 x 27 x 1 C



A 13 x 18 x 1 C



R210912N

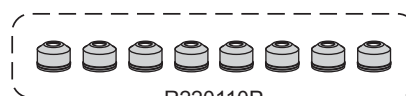

R220110P

DI TELLA/DKW

DKW



Motor/Engine	Cm³	HP	Ø
Wartburg	900	44	73.5
Wartburg	992	50	73.5

DKW: Graciela - Auto Unión 1000S
1953/67



Nº OE	Descripción/Description	Mat.	Ref.
	Jgo. de juntas para motor	●	140000
	Junta tapa cilindros Ø 75 \pm 1.40	NFT 1	140005
	Codo de agua	CG 1	140014
	Jgo. múltiple escape (3)	NFT 1	140016
6403163061	Múltiple admisión	NB 1	140017
	Jgo. juntas carburador	VS	140020
6403172711	Base carburador	NB 2	140025
6403122721	Tapa carburador	CB 1	140026
6403172881	Base bomba nafta	NB 1	140028
	Flotante tanque nafta	CG 1	140042
	Tapa lateral caja velocidades	NB 1	140051
	Tapa trasera caja velocidades	NB 1	140052
	Tapa hexagonal caja velocidades	CB 1	140053
	Tapón caja velocidades	CB 1	140054
	Directa caja velocidades	CB 1	140055
	Tapa diferencial	CB 1	140056

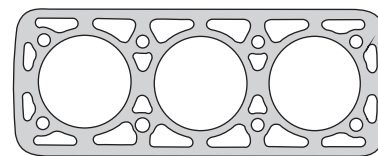

140005

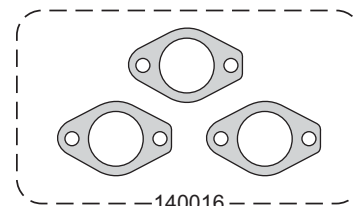

140016

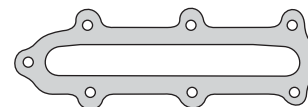

140017



140014

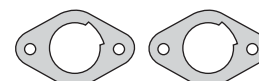

140025



140026



140028

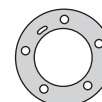

140042

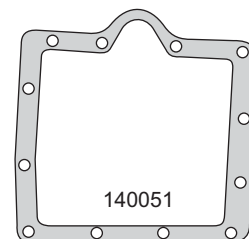

140051

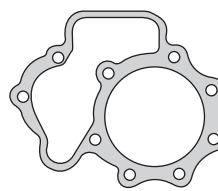

140052

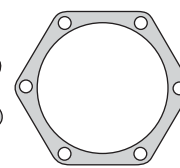

140053



140054



140055

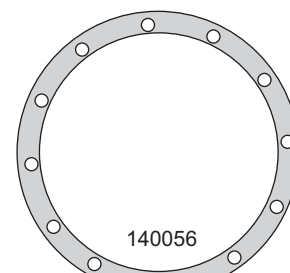









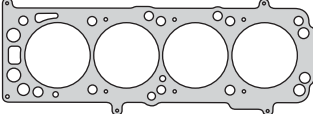

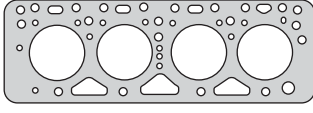

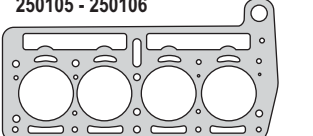

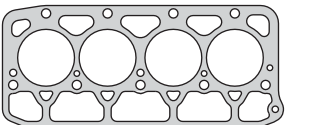

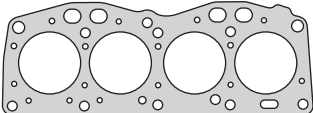

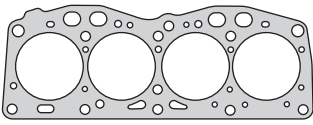

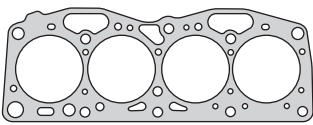

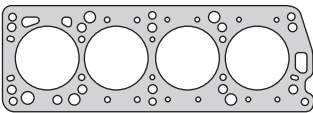
140056

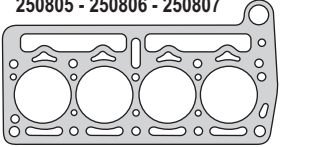
DI TELLA / DKW

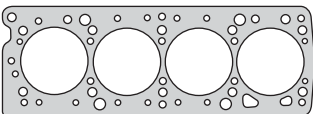

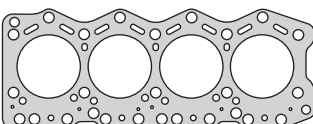







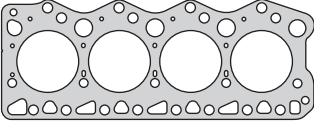
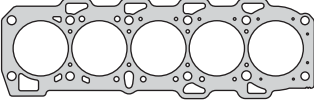
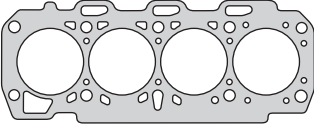
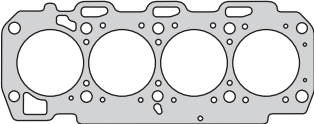
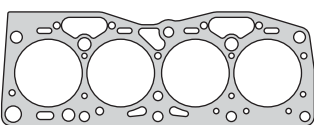
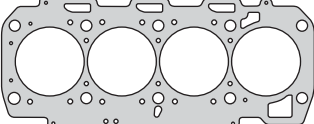
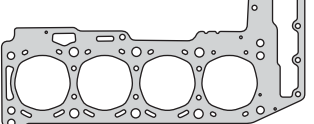
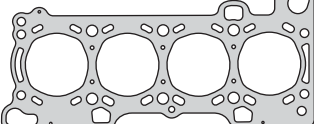
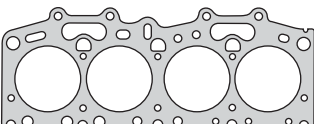
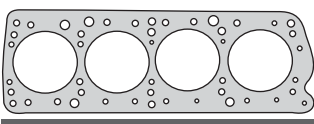
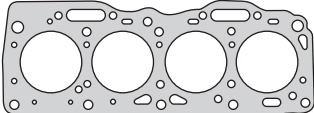



MOTORES NAFTA - DIESEL

	242208	Código	Ø	⊗	Kit Bulón	Modelo	Palio - Stilo - Palio Flex - Strada - Siena Flex 2003/... Idea Adventura HLX - G2 - G3 2006/...
	242208		82.0	1.25	B240400-1 (HAE12038)	Motor	1796cc. OHC-171190 - 17241C1 103HP - G2 102/105HP G3 110HP Ø80.5 (252300-R MLS)  pág. 155
	250005 - 250006	Código	Ø	⊗	Kit Bulón	Modelo	1100/103 1961/64
	250005 250006		74.0 74.0	1.40 2.40		Motor	1089cc. 65HP Ø68.5 (250000-R)  pág. 137
	250105 - 250106	Código	Ø	⊗	Kit Bulón	Modelo	600 E.R.S - 770 Coupe - 800 Spider 1962/76
	250105 250106		64.0 64.0	1.40 2.40	B250100	Motor	767cc. 100D - 170R 32HP Ø62 (250100-R)  pág. 138
	250205 - 250206	Código	Ø	⊗	Kit Bulón	Modelo	1500 Berlina - Familiar - Multicarga 1963/69 1600 Berlina - Coupe 1969/72
	250205 250206		80.0 80.0	1.70 2.40	B250200 (HAS19038)	Motor	1481cc. 115C 72HP Ø77 1600cc. 115C 76HP Ø78 (250200-R)  pág. 139
	250405 - 250406 - 250407	Código	Ø	⊗	Kit Bulón	Modelo	128 - 147 - Spazio - Brio - Ritmo 60 - Strada 60 1971/...
	250405 250406 250407		81.0 81.0 81.0	1.40 2.40 1.40	B250400 (HAS19038)	Motor	1116cc. 128A 55/60HP Ø80 (250400-R)  pág. 140
	250505 - 250506 - 250507	Código	Ø	⊗	Kit Bulón	Modelo	128 - Europa - 147 - Spazio 1971/81 Regata 70 - Ritmo Strada 65 - Uno 70 - Iava - 147 Sorpasso Fiorino1982/... Ritmo Strada 75 - Ritmo Strada 85 1978/82
	250505 250506 250507		87.7 87.7 87.7	1.40 2.40 1.40	B250400 (HAS19038)	Motor	1290cc. 128A1 73HP Ø86.4 - 1301cc. 138B2 68/70HP Ø86.4 1498cc. 138A2-A4 75/85HP Ø86.4 (250500-R)  pág. 142
	250605 - 250606 - 250607	Código	Ø	⊗	Kit Bulón	Modelo	128 Regatta '85 - Ritmo1986/90 - Duna - Uno - Super Europa 1983/... Elba - Premio - Fiorino
	250605 250606 250607		87.3 87.3 87.3	1.70 2.40 1.70	B260200 (HAS15038)	Motor	1498cc. 138C3 75/85HP Ø86.4 (250600-R)  pág. 144
	250705 - 250706	Código	Ø	⊗	Kit Bulón	Modelo	125 (Bialbero) - Berlina - Sport Multicarga - Mirafiori 1972/74
	250705 250706		81.0 81.0	1.40 2.40	B250700 (HAS17038)	Motor	1608cc. 125AB - 125A 110HP Ø80 (250700-R)  pág. 146
	250805 - 250806 - 250807	Código	Ø	⊗	Kit Bulón	Modelo	133 - 600S - Berlina de Lujo 1977/82 - 850 - 850 Van 1965/76 Uno 45 1974/... - 127 Especial 1983/88
	250805 250806 250807		66.0 66.0 66.0	1.40 2.40 1.40	B250800 (HAS17038)	Motor	843cc. 100R 32HP Ø62.5 - 100G 37HP Ø65 (250800-R)  pág. 147 903cc. 146A 45HP Ø65 (250800-R)  pág. 147
	250905 - 250907	Código	Ø	⊗	Kit Bulón	Modelo	Regata 100S 1985/...
	250905 250907		85.0 85.0	1.70 1.70	B250700 (HAS17038)	Motor	1585cc. 149A 100HP Ø84 (250900-R)  pág. 148
	251107	Código	Ø	⊗	Kit Bulón	Modelo	Ducato 14 - Ducato 18 Maxi - Ducato 14D - Ducato 18D Maxi 1998/... Iveco Daily 30.8 - Daily 35.8 1996/...
	251107		96.0	1.70	B251100 (HAS17038)	Motor	2799cc. 8140.63 87/89HP Ø94.4 - DIESEL (251100-R)  pág. 150 Iny. Indirecta











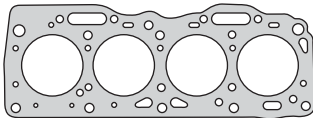

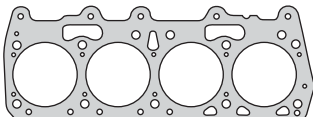

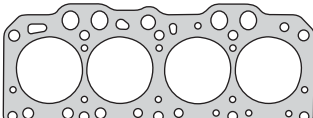

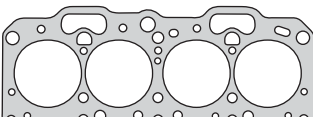

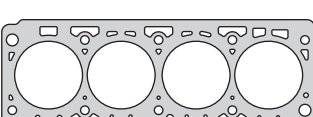

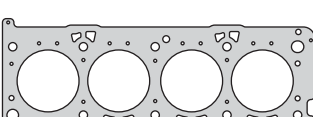





MOTORES NAFTA - DIESEL

251407 	Código	Ø	≠	Kit Bulón	Modelo
	251407	95.0	1.40	B270100 (HAS17038)	Ducato TD 1985/... - Iveco Daily TD 1985/89
251807 	Código	Ø	≠	Kit Bulón	Modelo
	251807-SM 252007-1M 252007-2M	83.0 83.0 83.0	1.70 1.80 1.95	B251800 (HAR12063)	Marea TD 1996/99 - Lancia Kappa TD 1994 - 1995/00
252007 - 252008 	Código	Ø	≠	Kit Bulón	Modelo
	252007-SM 252007-1M 252007-2M 252008-SM 252008-1M 252008-2M	83.0 83.0 83.0 83.0 83.0 83.0	1.40 1.50 1.60 1.35 1.45 1.55	B252000 (HAR12063)	Brava - Bravo TD 1996/99 - Marengo TD - Marea TD
252107 - 252108 	Código	Ø	≠	Kit Bulón	Modelo
	252107-SM 252107-1M 252107-2M 252108-SM 252108-1M 252108-2M	83.0 83.0 83.0 83.0 83.0 83.0	1.60 1.70 1.80 1.60 1.70 1.80	B252000 (HAR12063)	Brava - Bravo TD - Multipla TD - Marea TD 1998/...
252205 - 252207 	Código	Ø	≠	Kit Bulón	Modelo
	252205 252207	87.0 87.0	1.70 1.70		Regata 75 i.e - Ritmo 75 i.e - Uno 75 i.e 1986/90 - Fiorino i.e 1988/93 Lancia Delta i.e, Prisma i.e 1986/89, Delta, Prisma 1986/92
252407 	Código	Ø	≠	Kit Bulón	Modelo
	252407-SM 252407-1M 252407-2M 252407-3M	83.0 83.0 83.0 83.0	0.85 1.00 1.20 1.30	B252000 (HAR12063)	Marea JTD 2000/02 - Stilo JTD - Idea JTD 2003/... - Punto 2003/... Palio JTD 2002/... - Strada
252708 	Código	Ø	≠	Kit Bulón	Modelo
	252708-1M 252708-2M 252708-3M	96.8 96.8 96.8	1.20 1.30 1.40		Daily - 40 S14 - 3.0 HPI - Euro III TD 2008/... - 55 C16 - 3.0 HPI Euro III TD 2008/...
252808 	Código	Ø	≠	Kit Bulón	Modelo
	252808-1M 252808-2M 252808-3M	89.0 89.0 89.0	1.10 1.20 1.30		Ducato JTD 2002/... - 2006/... Cargo - Maxicargo - Furgon - Multijet 2010/...
260007 	Código	Ø	≠	Kit Bulón	Modelo
	260007-SM 260007-1M 260007-2M 260007-3M	77.0 77.0 77.0 77.0	1.65 1.80 1.95 2.20	B260000 (HAS13038) (HAS17038)	147 - Duna - Fiorino - Spazio - Uno 1985/...
260105 - 260107 	Código	Ø	≠	Kit Bulón	Modelo
	260105 260107	85.0 85.0	1.70 1.70	B260100 (HAR10168)	Tempra - Tipo 1992/95 - Regatta 2000 - Bialbero - Tempra 1989/... Tempra 1992/... - Tipo i.e. 1989/93 - Cromia i.e - Coupe i.e - Turbo 1993/... Tempra i.e - Tipo i.e - Cromia i.e - Cromia i.e Turbo 1992/95
260205 - 260206 - 260207 	Código	Ø	≠	Kit Bulón	Modelo
	260205 260206 260207	81.0 81.0 81.0	1.70 2.40 1.65	B260200 (HAS15038)	Spazio - Duna - Tipo - Uno - Vivace - Palio - Siena 1988/91 Fiorino 1993/95
					Motor
					2445cc. 8140.21 92HP Ø93 2499cc. 8140.27 103HP Ø93 - DIESEL (251495-R)  pág. 151
					2387cc. 185A2 124HP - 838A3 - 838A7 124HP Ø82 - DIESEL
					1910cc. 182A8/A7 75/100HP Ø82 - DIESEL (252001-R)  pág. 153
					1910cc. 182 B4 105HP Ø82 - DIESEL (252101-R)  pág. 154
					1498cc. 149A5/C1 - 138C3 - 483C3 - 831B1 75/80HP - M202 82HP Ø86.4
					1910cc. 186 A6 - 192 A1/3 - 188 B2 - 182 B9 80/100/110/115HP Ø82 DIESEL (252401-R)  pág. 156
					2998cc. 8210.42E2 - F1CE 0481 136/155HP Ø95.8 16V (DOHC) DIESEL (252701-R)  pág. 157
					2286cc. F1AE (DOHC) 110/120/127HP Ø88 DIESEL (252801-R)  pág. 158
					1301cc. 4TD - 146B 45HP Ø76.1 - DIESEL (260001-R)  pág. 161
					1756cc. 835C 105HP - 1987cc. 154C 90/110HP Ø84 (260100-R)  pág. 162 1995cc. 160A 126HP - 154E 140HP - Zact 16V Ø84 (260600-R)  pág. 167 1995cc. 154C4/159A6 115/153HP - Zact 8V Ø84 (260800-R)  pág. 169
					1372cc. 160A1 71HP - 146C1/5 67/72HP - 159A2 78HP Ø80.5 (260200-R)  pág. 163











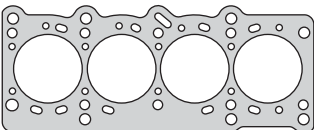



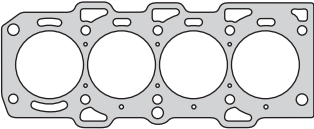



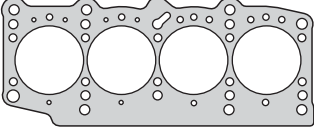
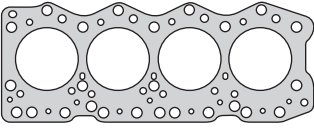
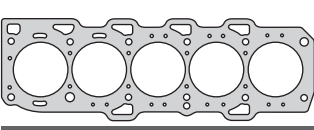



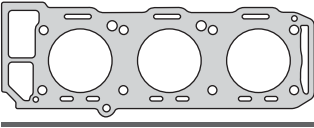
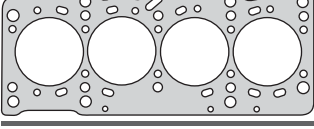

MOTORES NAFTA - DIESEL

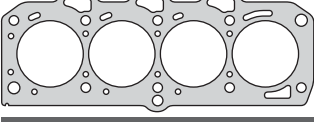
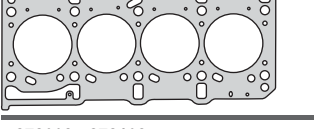
	260305 - 260306 - 260307			Código	Ø	≠	Kit Bulón	Modelo	Duna - Uno - Regatta - Palio - Siena - Premio - Elba - Tipo Fiorino 1988/...
	260305	87.0	1.70	B260200 (HAS15038)	Motor	1581cc. Sevel 84/88HP - 146C6 75HP - 159A3 76/78HP 160A2 82HP Ø86.4 (260300-R)  pág. 164			
	260306	87.0	2.40						
	260307	87.0	1.70						
	260407			Código	Ø	≠	Kit Bulón	Modelo	Duna - Uno - Regatta - Fiorino 1985/...
	260407-SM	84.0	1.70	B260400 (HAR12063)	Motor	1697cc. 149B - 146B 60HP Ø82.6 - DIESEL (260401-R)  pág. 165			
	260407-1M	84.0	1.80						
	260407-2M	84.0	1.95						
260407-3M	84.0	2.20							
	260505			Código	Ø	≠	Kit Bulón	Modelo	147 - Oggi - Panorama - Uno - Premio Trend
	260505	77.0	1.40	B260500	Motor	1049cc. 127AB 206 60/70HP Ø76 1300cc. 127AB 2C 60/70HP Ø76 (260500-R)  pág. 166			
	260705 - 260707			Código	Ø	≠	Kit Bulón	Modelo	Uno Mille - Palio - Siena 1983/... Palio 1.0 ED/EDX MPI 96 - Palio 1.5 EL MPI 96
	260705	77.0	1.80	B260500	Motor	994cc. 146B 48/61HP Ø76 (260700-R)  pág. 168 994cc. ED/EDX MPI 48/61HP Ø76 - 1495cc. EL MPI 76HP Ø76 (270200-R)  pág. 176			
	260707	77.0	1.90						
	260905 - 260907			Código	Ø	≠	Kit Bulón	Modelo	Palio - Siena - Tipo 1.6 - Bravo - Marea - Multipla 1999/...
	260905	87.0	1.80	B260900 (HAR12063)	Motor	1581cc. 182A4/A6 - 186A3/A4 16V 103HP Ø86.4 (260900-R)  pág. 170			
	260907	87.0	1.80						
	261108			Código	Ø	≠	Kit Bulón	Modelo	Palio - Siena - Marea - Multipla 2001/...
	261108	81.5	0.35	B260900 (HAR12063)	Motor	1596cc. 182B6 - 178E7 103HP Ø77 Torque 16V (261100-R MLS)  pág. 171			
	270007			Código	Ø	≠	Kit Bulón	Modelo	Fiorino - Uno - Tipo - Palio - Ducato D/TD Tipo - Tempra - Palio - Siena TD
	270007-SM	84.0	1.70	B260400 (HAR12063)	Motor	1697cc. 149B - 176A 58/69HP Ø82.6 - DIESEL 1929cc. 160D - 280A1 65/90HP Ø82.6 - DIESEL (260401-R)  pág. 172			
	270007-1M	84.0	1.80						
	270007-2M	84.0	1.95						
270007-3M	84.0	2.10							
	270008			Código	Ø	≠	Kit Bulón	Modelo	Fiorino - Uno - Tipo - Palio - Ducato D/TD Tipo - Tempra - Palio - Siena TD
	270008-SM	83.5	1.65	B260400 (HAR12063)	Motor	1697cc. 149B - 176A 58/69HP Ø82.6 - DIESEL 1929cc. 160D - 280A1 65/90HP Ø82.6 - DIESEL (260401-R)  pág. 172			
	270008-1M	83.5	1.75						
	270008-2M	83.5	1.85						
270008-3M	83.5	1.95							
	270107			Código	Ø	≠	Kit Bulón	Modelo	Ducato TD 1990/94 - Ducato TDS 1994/96 - Ducato TDSE 1996/... Ducato 14TDS - Ducato Maxi 18TDS 1996/...
	270107-SM	96.00	1.30	B270100 (HAS17038)	Motor	2499cc. 8140.27/47R/47.X230 Ø93 - DIESEL (270100-R)  pág. 174 2799cc. 8140.43 122HP Ø94.4 - DIESEL (270300-R)  pág. 177			
	270107-1M	96.00	1.40						
	270107-2M	96.00	1.50						
270107-3M	96.00	1.60							
	270107			Código	Ø	≠	Kit Bulón	Modelo	Ducato JTD 2006/09 - Iveco Turbo Daily 35.10 - 49.12 1996/... 45.10 - 49.10 - 40.10 - Turbo Daily 49.12 - 60.12 Intercooler
	270107-SM	96.00	1.30	B270100 (HAS17038)	Motor	2798cc. 8140.43S Euro III 122/125HP Ø94.4 (252901-R)  pág. 159 2799cc. 8140.23/43 99/122HP Ø94.4 - DIESEL (271101-R)  pág. 185			
	270107-1M	96.00	1.40						
	270107-2M	96.00	1.50						
270107-3M	96.00	1.60							
	270407			Código	Ø	≠	Kit Bulón	Modelo	Nouvo Ducato 1989/94 - Ducato 1994/... - Daily 30.8 - 35.8 1996/...
	270407-1M	95.0	1.50	B270100 (HAS17038)	Motor	2499cc. 8140.67 55HP - 8140.67X230 85HP - 8140.67F37 82HP Ø93 DIESEL (270400-R)  pág. 179			
	270407-2M	95.0	1.60						
	270407	95.0	1.70						

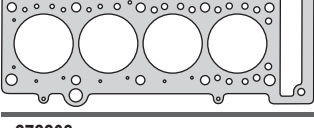

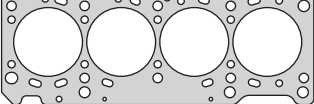
MOTORES NAFTA - DIESEL

	270507 - 270508 Código 270507 270507-1.90 270508	Ø 71.5 72.0 72.0	∇ 1.20 1.90 0.35	Kit Bulón B270500  (HAS13038)	Modelo Panda 1986/... - Uno 1989/95, 1998/... - Palio 2001/... Punto 60 Cabrio - Palio 75 - Siena 1995/... - Punto Selecta 1993/99 Punto 60 1993/99 - Uno - Palio - Siena - Mille Fire	Motor 999cc. 146A2/156A2/A3 - 1108cc. 176B2/178B9 (251095-R)  pág. 149 1242cc. 176B4/B1/A7 60HP - 178B5 73HP Ø70.8 (251795-R)  pág. 152 999/1300cc. Fire 8V MPI 50/75HP Ø70 (270500-R)  pág. 181	
		270607 Código 270607	Ø 84.0	∇ 1.70	Kit Bulón B270600  (HAR10168)	Modelo 145/146/155/156 Twin Spark 16V 1996/... - 156 Twin Spark 1997/... 145/146/156 Twin Spark 1997/... - GTV Twin Spark 1998/00 Spider Twin Spark 1998/00	Motor 1598cc. 676.01 - 1747cc. 671.06/99 - 322.01 Ø82 (270600-R)  pág. 182 1598cc. 321.02 - 676.01 - 1747cc. 322.01 Ø82 (271800-R)  pág. 190
			270707 - 270708 Código 270707 270708	Ø 72.0 72.0	∇ 1.20 0.35	Kit Bulón B270700	Modelo Palio - Siena - Palio Weekend - Palio Novo - Novo Siena - Doblo
	270807 Código 270807		Ø 95.0	∇ 1.70	Kit Bulón	Modelo 131 - 132 1978/... - Argenta 1981/... - Ducato 1981/89 Iveco Daily 1979/... - Renault Master 1981/88	Motor 2445cc. 8144.61 53HP - S8U 730/731 52HP Ø93 - DIESEL
		270907 Código 270907	Ø 83.0	∇ 1.80	Kit Bulón B270900  (HAR10168)	Modelo Marea 1996/98 - 1998/... - Coupe 1996/01 - Bravo 1995/98	Motor 1998cc. 182A1 147HP - 182B3/B7 147/155HP Ø82 (270900-R)  pág. 184 1998cc. 182B7/B3 145/155HP Ø82 (271300-R)  pág. 188
		271007 Código 271007	Ø 95.0	∇ 1.70	Kit Bulón	Modelo Alfa Romeo Alfa 166 1998/00, 2000/... - Alfa GTV 1996/00, 2001/... Alfa Spider 2001/... - Alfa 147 - Alfa GTV 2003/...	Motor 2959cc. 161.02 - 343.01 226HP - 361.01 220HP - 161.05 218HP Ø93 3179cc. 932A 250HP - 936A6 240HP Ø93
		271207 - 271208 Código 271207 271208	Ø 72.0 72.0	∇ 1.20 0.35	Kit Bulón B270500  (HAS13038)	Modelo Palio - Siena - Strada - Fire 1.3 - Fiorino - 500 2007/... - Fire 1.4 ELX Evo 2010/... - Idea 2003/... - Palio Fase II/III 2007/13 - Siena Generación III MPI 2002/... - Grande Punto 2005/... - Linea 2007/... - Strada Fase III	Motor 1368cc. Fire 8V 80/81HP Ø72 (271200-R MLS)  pág. 187 1242cc. 350 A1 70HP Ø72 (271900-R MLS)  pág. 191 1368cc. 169 A4 77/80/82HP Ø72 (271900-R MLS)  pág. 191
		271407 Código 271407	Ø 83.0	∇ 1.30	Kit Bulón	Modelo Bravo 1995/... - Marea 1996/00 - Lancia Ypsilon 1995/01	Motor 1370cc. 182A3 - 840A2 80HP Ø82
		271508 Código 271508-SM 271508-1M 271508-2M	Ø 70.5 70.5 70.5	∇ 0.70 0.80 0.90	Kit Bulón	Modelo Punto ELX JTD 2003/..., Strada Trekking Fase III JTD 2010/...	Motor 1248cc. 188A9 (DOHC) 16V 70HP Ø69.6 DIESEL (271500-R MLS)  pág. 189
		272008 - 272108 Código 272008 272108	Ø 78.0 82.0	∇ 0.60 0.60	Kit Bulón B272000	Modelo Idea Essence - Idea Sporting - Idea Adventure - Siena Fase III Essence Strada Fase III Adventure - Palio Wend Fase III/IV Adventure Adventure 2010/... - Punto Essence - Fiat Punto - Idea - Linea 2011/...	Motor 1598cc. E.torQ 178D20.11/D22.11 115HP Ø77 (272000-R MLS)  pág. 192 1747cc. Fiat E-Torq (SOHC) 16V 130HP Ø81 (272100-R MLS)  pág. 193
			272208 Código 272208	Ø 72.5	∇ 0.60	Kit Bulón B270500  (HAS13038)	Modelo Palio - Siena Generación III - Uno Fase II 2010/...

FIAT



Motor/Engine	Cm³	HP	Ø
	1089	65	68.5

Fiat: 1100/103 1961/64



Nº OE	Descripción/Description	Mat.	Ref.
	Jgo. de juntas para motor		250000-R
4015455	Junta tapa cilindros Ø 74 \pm 1.40	NFT 1	250005
4015455	Junta tapa cilindros Ø 74 \pm 2.40	NFT	250006
859472	Junta tapa válvulas	CG 1	250010
869695	Junta para cárter	CG 1	250011
367200	Tapa distribución	CB 1	250012
367198	Placa distribución	CB 1	250013
853240	Tapa bomba de agua	NB 1	250014
4015881	Múltiple admisión y escape	NFT 1	250016
860639	Salida de escape	FCH 1	250018
367185	Termostato	CB 1	250019
	Jgo. juntas carburador SOLEX E 32/35	VS	250020
	Jgo. juntas carburador WEBER 28/32/36	VS	250220
	Jgo. juntas carburador SOLEX 32 PBIC	VS	250221
	Base carburador	NB 1	250025
810874	Base bomba nafta	NB 1	250028
869808	Acople bancada cigüeñal	NB 1	250031
869027	Filtro aceite a block	NB 1	250032
367316	Brida bomba aceite	NB 1	250033
374464	Tapa descarga bomba aceite	NB 1	250034
815416	Tubo bomba aceite base	NB 1	250035
367188	Tapa válvulas lateral	CG 1	250036
853701	Salida bomba agua	NB 1	250037
	Brida toma aire	NB 1	250038
	Jgo. juntas caja velocidades	VS	250050
	Tapa diferencial	CB	250059
	Kit de retenes completo		R250000
40004350	Retén bancada 64 x 80 x 8	N 1	R250111N
	Retén distribución 40 x 60 x 10	N 1	R250012N

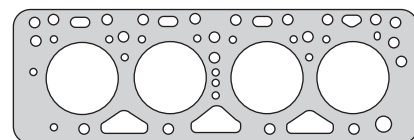

250005

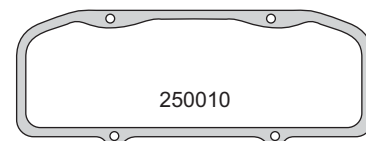

250010

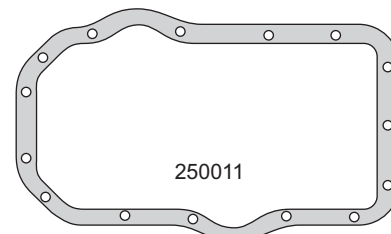

250011



250036



250016

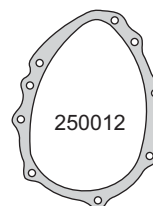

250012

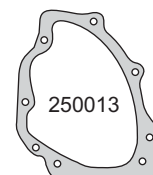

250013



250014



250018



250019

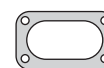

250025



250028



250031



250032



250033



250034



250035



250037



250038



R250012N



R250111N

FIAT



Motor/Engine Cm³ HP Ø

100D - 170R 767 32 62

Fiat: 600 (E.R.D) - 770 Coupe
800 Spider 1962/76



Nº OE	Descripción/Description	Mat.	Ref.
	Jgo. de juntas para motor		250100-R
	Jgo. de juntas superior	●	250195
4064640	Junta tapa cilindros Ø 64 ± 1.40	NFT 1 1	250105
4064640	Junta tapa cilindros Ø 64 ± 2.40	NFT	250106
	Jgo. tornillos tapa cilindros (HAS13038)		B250100
4117850	Junta tapa válvulas	CG 1 1	250110
	Jgo. junta para cárter (4)	CG	250111
4107391	Tapa distribución	NB	250112
4065244	Tapa bomba de agua	NB	250114
4135158	Múltiple admisión y escape	FCH	250115
4135158	Múltiple admisión y escape	NFT 1 1	250116
876075	Salida de escape	FCH 1 1	250118
	Bomba de agua a block	NB	250119
400425	Jgo. juntas carburador WEBER 28 ICP	VS	250120
	Jgo. juntas carburador HOLLEY 1975/76	VS	250121
	Jgo. juntas carburador WEBER 30-ICF-19	VS	250122
	Jgo. juntas carburador BRESSEL y GALILEO	VS	250123
4121933	Base superior carburador	NB 1 1	250125
4100576	Entre carburador y múltiple	NB 1	250825
9910788	Tapa carburador	CB	250126
881452	Superior bomba aceite	NB	250127
4081258	Base bomba nafta 0,8	NB	250128
4052518	Brida bomba aceite	NB	250129
4057986	Inferior caño bomba aceite	NB	250130
4064079	Base intermedia carburador Weber 28 IEP	NB 1	250131
4064078	Base inferior carburador Weber 28 IEP	NB 1	250132
883831	Base filtro aceite a block	NB	250133
97050117	Termostato	CB 1 1	250135
4172904	Porta retén bancada trasera	NB	250136
1/02795/60	Tapa tubo entrada aceite	CG	250137
9904841	Vaso filtro nafta	CG	250138
987112	O'ring balanceador armónico G 101 x 4.3	GS	250140
4065247	Base termostato	NB 1 1	250141
1458.030	Junta vaso de nafta	CG	450041
	Porta aro cigüeñal	NB	250142
	Base carburador a múltiple Holley Web.600R	NB 1 1	250143
	Base bomba nafta 0.5	NB	250144
	Soporte caño escape	AC	250145
	Jgo. juntas caja velocidades	VS	250150
	Palier	CB	250154
4117850	Jgo. juntas para cárter	CG	250160
	Tapa válvulas	CG	250161
	Suplemento tapa cilindros	AL	250185
	Junta tapa cilindros competición (0.30)	CU	250190-0.30
	Junta tapa cilindros competición (0.60)	NFT	250190-0.60
	Junta tapa cilindros competición (0.80)	NFT	250190-0.80
	Kit de retenes completo		R250100
	Jgo. retén válvulas (8)	P	1 R250110P
40004350	Retén bancada 64 x 80 x 8	N	1 R250111N
	Retén distribución 42 x 56 x 7	N	1 R250112N

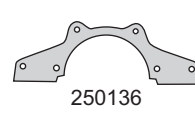
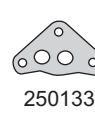
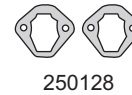
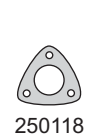
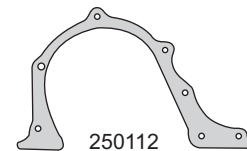
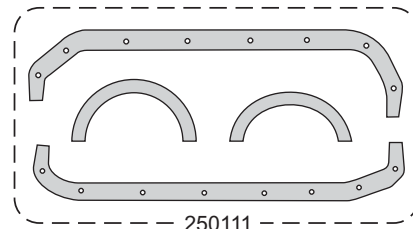
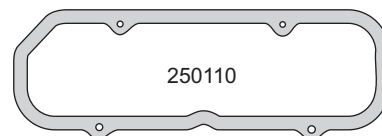
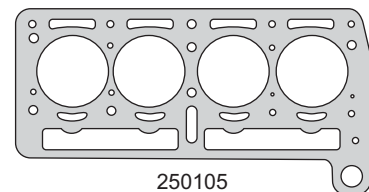

FIAT / ALFA ROMEO

FIAT



Motor/Engine	Cm³	HP	Ø
115C	1481	72	77
115C	1600	76	78

Fiat: 1500 Berlina - Familiar - Multicarga 1963/69
1600 Berlina - Coupe 1969/72
Seat: 1500 1963/71



Nº OE	Descripción/Description	Mat.	Ref.
	Jgo. de juntas para motor		250200-R
	Jgo. de juntas superior		250295
4956553	Junta tapa cilindros Ø 80 ± 1.70	NFT 1 1	250205
4056553	Junta tapa cilindros Ø 80 ± 2.40	NFT	250206
	Jgo. tornillos tapa cilindros (HAS19038)		B250200
4027732	Junta tapa válvulas	CG 1 1	250210
	Jgo. junta para cárter (4)	CG	250211
4025572	Tapa distribución	NB	250212
4025776	Bomba de agua	NB	250214
4088354	Jgo. múltiple escape	CHA	250215
	Jgo. múltiple escape (2)	NFT 1 1	250216
	Jgo. múltiple admisión (3)	NFT 1 1	250217
4061096	Salida de escape	FCH 1 1	250218
4027777	Placa bomba de agua	NB	250219
	Jgo. juntas carburador WEBER 28/32 y 36	VS	250220
	Jgo. juntas carburador SOLEX 32 PBIC	VS	250221
	Jgo. juntas carburador WEBER 34 DCHD	VS	250321
	Jgo. juntas carburador SOLEX 34 PAIA 2	VS	250223
4069488	Base carburador 1500	NB 1 1	250225
4127681	Base carburador 1600	NB 1 1	250325
4089702	Tapa termostato	NB 1 1	250227
4081257	Base bomba nafta 0.8	NB	250128
4025578	Desahogo caño aceite	CG	250228
4026063	Brida caño aceite	NB	250229
4025778	Base carcaza termostato	NB 1 1	250230
	Brida soporte bomba aceite	NB	250231
9913568	Vaso nafta	CG	250233
4026077	Entre caño bomba aceite	NB	250234
4076865	Arandela base distribuidor	NB	250235
4025574	Porta retén bancada 1500	NB	250236
4230787	Porta retén bancada 1600	NB	250237
	Base bomba aceite	NB	250238
	Pre-filtro nafta	CG	250239
987112	O'ring balanceador armónico G 101 x 4.3	GS	250140
4071514	O'ring retén guía válvulas G 5.8 x 1.78	GS	250241
987099	O'ring varilla aceite	GS	250242
4020448	Entrada carga aceite	CG	250243
	Base bomba nafta 0.5	NB	250144
4081258	Base bomba nafta 1.5	NB	250248
	Jgo. juntas caja velocidades	VS	250250
	Palier	CB	250256
	Tapa diferencial	CB	250259
	Jgo. juntas para cárter	CG	250260
4027732	Junta tapa válvulas	CG	250261
	Suplemento tapa cilindros	AL	250285
	Kit de retenes completo		R250200
	Jgo. retén válvulas (8)	P	1 R250110P
	Retén bancada 80 x 100 x 10	N	1 R250211N
	Retén distribuidor 45 x 65 x 10	N	1 R250212N

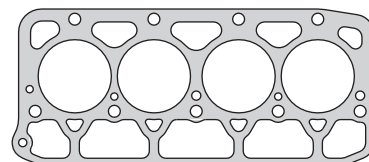

250205

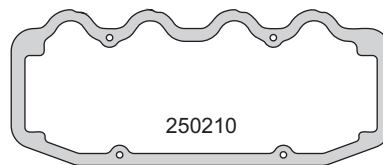

250210

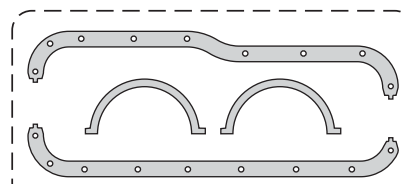

250211

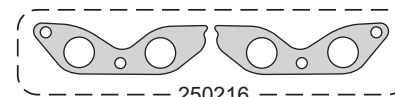

250216



250217

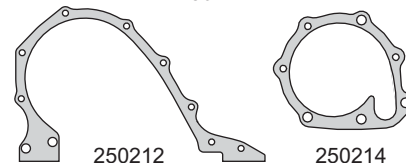

250212

250214

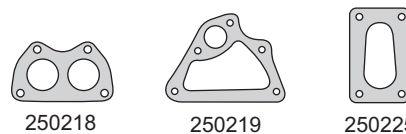

250218

250219

250225

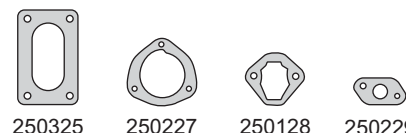

250325

250227

250128

250229

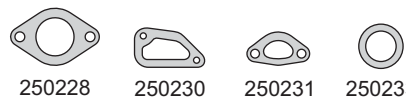

250228

250230

250231

250233



250234

250235

250238

250239

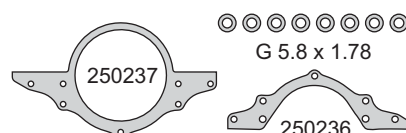

250237

G 5.8 x 1.78

250236



250242

G 101 x 4.3

250243



R250212N

R250211N



R250110P

FIAT / ALFA ROMEO

FIAT



Motor/Engine	Cm³	HP	Ø
128A	1116	55/60	80

Fiat: 128 - 147 - Spazio - Brio - Ritmo 60
Strada 60 1971/...



Nº OE	Descripción/Description	Mat.		Ref.
1041169	Jgo. de juntas para motor			250400-R
	Jgo. de juntas superior		●	250495
4321213	Junta tapa cilindros Ø 81 ± 1.40	NFT	1	250405
4321213	Junta tapa cilindros Ø 81 ± 2.40	NFT		250406
	Junta tapa cilindros Ø 81 ± 1.40 (N.R. HAS19038)	NFT		250407
	Jgo. tornillos tapa cilindros			B250400
97052381	Junta tapa válvulas superior	CG	1	250410
4179038	Junta para cárter	CG	1	250411
4179043	Tapa distribución	NB	1	250412
97052378	Tapa bomba de agua	NB	1	250414
4195133	Jgo. múltiple admisión y escape (2)	NFT	1	250416
	Jgo. múltiple admisión y escape IAVA	NFT		250616
4179155	Bomba de agua a block	NB	1	250419
97052379	Bomba de agua	NB	1	260319
	Jgo. juntas carburador WEBER 32	VS		250420
	Jgo. juntas carburador WEBER (3 series)	VS		250520
	Jgo. juntas carburador WEBER	VS		250421
	Jgo. juntas carburador WEBER IAVA	VS		250422
	Jgo. juntas carburador WEBER 30 IBA/32	VS		250424
4428157	Base carburador	NB	2	250425
9922076	Tapa carburador	CB		250426
	Base filtro aceite	NB	1	250427
4179113	Base bomba nafta 0.8	NB	1	250128
4179114	Separador bomba nafta 0.5	NB	1	250428
4193959	Superior bomba agua	NB	1	250429
4194902	Brida caño calefactor	NB	1	250430
97051650	Caballote T.V. 0.2	NB	1	250431
97051650	Caballote T.V. 0.5	NB		250432
97051650	Caballote T.V. 0.8	NB		250433
4195119	Tapa inspección cigüeñal	NB	1	250434
4179117	Tapa inspección árbol levas 0.3	NB		250534
4179117	Tapa inspección árbol levas 0.8	NB	1	250435
4179117	Tapa inspección árbol levas 0.5	NB		250535
4179117	Tapa inspección árbol levas 1.5	NB		250635
4179183	Termostato	CB	1	250436
97052380	Base termostato	NB	1	250437
4179148	Brida caño aceite	NB	1	250438
4179138	Base bomba aceite	NB	1	250439
4230783	Bomba aceite tubo escape	NB	1	250440
4302267	Porta retén bancada trasero	NB	1	250441
4158100	Caño respiradero cárter	NB	1	250442
4109133	Apoyo distribuidor	NB	1	250443
9919743	Intermedia carburador	NB		250444
4205663	Separador bomba nafta 0.8	NB		250445
4205664	Separador bomba nafta 1.5	NB	1	250446
97051650	Caballote T.V. 1.5	NB		250448
	Jgo. juntas caja velocidades	VS		250450
	Jgo. juntas caja velocidades	VS		250451
	Tapa válvulas superior (2.7)	NB		250459
4179038	Junta para cárter	CGT		250460
97052381	Junta tapa válvulas superior	CGT		250461
	Kit de retenes completo			R250400
	Jgo. retén válvulas (8)	V	1	R250410V

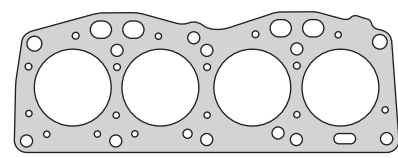

250405

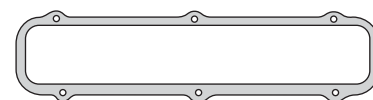

250410

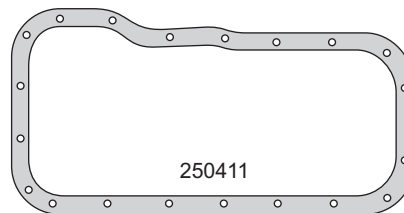

250411

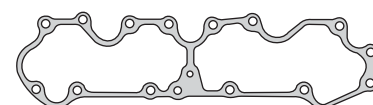

250431

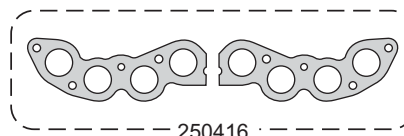

250416



250412

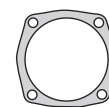

250414



250419



260319



250425



250426



250427



250128



250428



250429



250430



250434



250435



250436



250437



250438



250439



250440



250441



250442

FIAT / ALFA ROMEO

FIAT



Motor/Engine	Cm³	HP	Ø
128A1	1290	73	86.4
138B2	1301	68/70	86.4
831B	1301	75	86.4
138A2/A4	1498	75/85	86.4

Fiat: 128 - Europa - 147 - Spazio 1971/81
Regata 70 - Ritmo Strada 65 - Uno 70
lava - TV - 147 Sorpasso Fiorino1982/...
Ritmo Strada 75/85 1978/82

Lancia: Prisma 1983/... - Delta 1986/92
Prisma - Delta 1978/81



Nº OE	Descripción/Description	Mat.	Ref.
1041194	Jgo. de juntas para motor		250500-R
	Jgo. de juntas superior		250595
4444452	Jta. tapa cilindros Ø 87.7 ± 1.40	NFT 1 1	250505
4444452	Jta. tapa cilindros Ø 87.7 ± 2.40	NFT	250506
4444452	Jta. tapa cilindros Ø 87.7 ± 1.40	NFT	250507
	Jgo. tornillos tapa cilindros (HAS19038)		B250400
97052381	Junta tapa válvulas	CG 1 1	250410
4179038	Junta para cárter	CG 1	250411
4179043	Tapa distribución	NB 1	250412
97052378	Tapa bomba de agua	NB 1	250414
4195133	Jgo. múltiple admisión y escape(2)	NFT 1 1	250416
7770023	Bomba de agua a block	NB 1	260319
	Jgo. juntas carburador WEBER	VS	250421
	Jgo. juntas carburador IAVA WEBER 49/D-F3	VS	250422
	Jgo. juntas carburador SOLEX	VS	250423
	Jgo. juntas carburador WEBER 30 IBA/22	VS	250424
4428157	Base carburador	NB 2 2	250425
9922076	Tapa carburador	CB	250426
4179113	Base bomba nafta 0.8	NB 1	250128
4179114	Separador bomba nafta 0.5	NB 1	250428
4193959	Superior bomba agua	NB 1	250429
4194902	Brida caño calefactor	NB 1 1	250430
97051650	Caballote T.V. 0.2	NB 1 1	250431
4218077	Tapa árbol levas distribución	NB 1	250531
97051650	Caballote T.V. 0.5	NB	250432
4218080	Tapa árbol levas trasero	NB 1	250532
97051650	Caballote T.V. 0.8	NB	250433
4195119	Tapa inspección cigüeñal	NB 1	250434
	Tapa inspección árbol levas 0.3	NB	250534
4179117	Tapa inspección árbol levas 0.8	NB 1 1	250435
4179117	Tapa inspección árbol levas 0.5	NB	250535
4179117	Tapa inspección árbol levas 1.5	NB	250635
4179183	Termostato	CB 1 1	250436
97052380	Base termostato	NB 1 1	250437
4179148	Brida caño aceite	NB 1	250438
4179138	Base bomba aceite	NB 1	250439
4230783	Bomba aceite tubo escape	NB 1	250440
7737202	Porta retén bancada trasero	NB 1	260241
4158100	Caño respiradero cárter	NB 1	250442
4109133	Apoyo distribuidor	NB 1	250443
9919743	Intermedia carburador	NB	250444
4205663	Separador bomba nafta 0.8	NB	250445
4205663	Separador bomba nafta 1.5	NB 1	250446
97051650	Caballote T.V. 1.5	NB	250448
	Jgo. juntas caja velocidades 4ta.	VS	250450
	Jgo. juntas caja velocidades 5ta.	VS	250550
	Jgo. juntas caja velocidades 4ta.	VS	250451
	Jgo. juntas caja velocidades 5ta.	VS	250551
4179038	Junta para cárter	CGT	250460
97052381	Junta tapa válvulas	CGT	250461
	Suplemento tapa cilindros	AL	250585
	Kit de retenes completo		R250400
	Jgo. retén válvulas (8)	V 1	R250410V

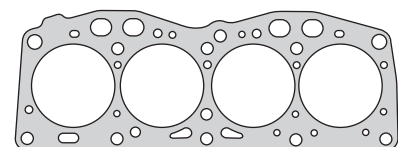

250505

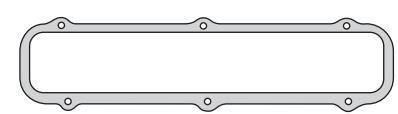

250410

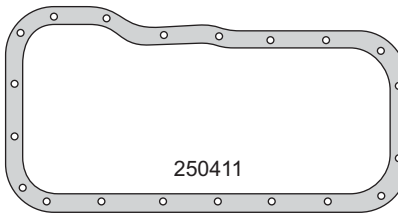

250411

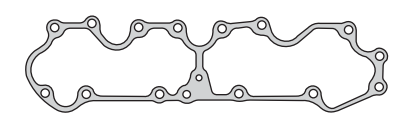

250431

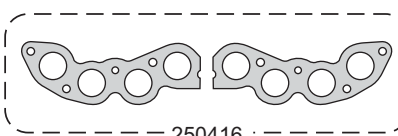

250416

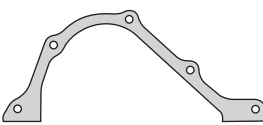

250412

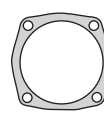

250414

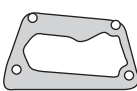

260319

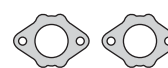

250425

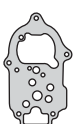

250426



250128



250428



250429



250430

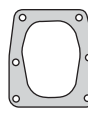

250531

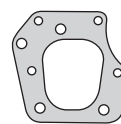

250532



250434



250435



250436



250437



250438



250439



250440

FIAT / ALFA ROMEO

FIAT



Motor/Engine	Cm³	HP	Ø
138C3	1498	75/85	86.4
831B1	1498	80/82	86.4

Fiat: 128 Regatta '85 - Ritmo1986/90
Duna - Uno - Super Europa 1983/...
Elba - Premio - Fiorino

Lancia: Delta - Prisma 1986/...



Nº OE	Descripción/Description	Mat.	1	2	Ref.
1041254	Jgo. de juntas para motor				250600-R
	Jgo. de juntas superior		●		250695
5957865	Jta. tapa cilindros Ø 87.3 ±1.70	NFT	1	1	250605
	Jta. tapa cilindros Ø 87.3 ±2.40	NFT			250606
5957865	Jta. tapa cilindros Ø 87.3 ±1.70	NFT			250607
	Jgo. tornillos tapa cilindros (HAS15038)				B260200
97052381	Junta tapa válvulas superior	CG	1	1	250410
4179038	Junta para cárter	CG		1	250411
4179043	Tapa distribución	NB		1	250412
97052378	Tapa bomba de agua	NB		1	250414
4195133	Jgo. múltiple admisión y escape (2)	NFT	1	1	250416
1482930	Salida de escape	FCH	1	1	250618
7770023	Bomba de agua a block	NB		1	260319
	Jgo. juntas carburador SOLEX 32 DISA	VS			250620
	Jgo. juntas carburador SOLEX C32/34 CIC	VS			250621
	Jgo. juntas carburador WEBER 2B	VS			250622
4428157	Base carburador	NB		2	250425
	Base carburador SOLEX DISA	NB	1	1	250625
	Tapa carburador SOLEX DISA	CB			250626
4179113	Base bomba nafta	NB		1	250128
4179114	Separador bomba nafta 0.5	NB		1	250428
4193959	Superior bomba agua	NB		1	250429
4194902	Brida caño calefactor	NB	1	1	250430
97051650	Caballote T.V. 0.2	NB	1	1	250431
4218077	Tapa árbol levas distribución hasta 1988	NB		1	250531
	Intermedio carburador SOLEX DISA	CB			250631
97051650	Caballote T.V. 0.5	NB			250432
4218080	Tapa árbol levas trasero hasta /88	NB		1	250532
97051650	Caballote T.V. 0.8	NB			250433
5937811	Tapa block (volante) 89/ ad.	NB		1	250633
4195119	Tapa inspección cigüeñal	NB		1	250434
4179117	Tapa inspección árbol levas 0.3	NB			250534
7575660	Tapa block (distribución) 89/ ad.	NB		1	250634
4179117	Tapa inspección árbol levas 0.8	NB	1	1	250435
4179117	Tapa inspección árbol levas 0.5	NB			250535
4179117	Tapa inspección árbol levas 1.5	NB			250635
4179183	Termostato	CB	1	1	250436
97052380	Base termostato	NB	1	1	250437
4179148	Brida caño aceite	NB		1	250438
4179138	Base bomba aceite	NB		1	250439
4230783	Bomba aceite tubo escape	NB		1	250440
7737203	Porta retén bancada trasera	NB		1	260241
4158100	Caño respiradero cárter	NB		1	250442
4109133	Apoyo distribuidor	NB		1	250443
4205663	Separador bomba nafta 0.8	NB			250445
4205664	Separador bomba nafta 1.5	NB		1	250446
97051650	Caballote T.V. 1.5	NB			250448
	Jgo. juntas caja velocidades	VS			250550
	Jgo. juntas caja velocidades	VS			250551
4179038	Junta para cárter	CGT			250460
	Kit de retenes completo				R250400
	Jgo. retén válvulas (8)	V		1	R250410V
	Retén bancada 64 x 80 x 8	P		1	R250111P

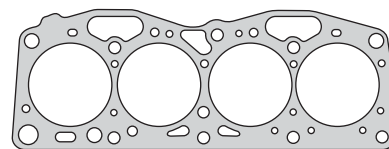

250605

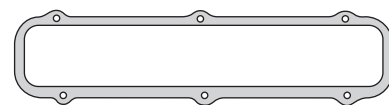

250410

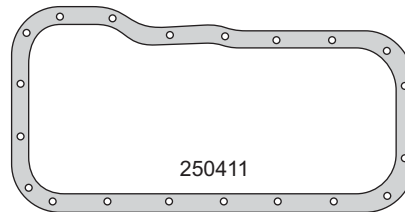

250411

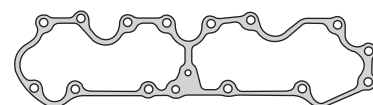

250431

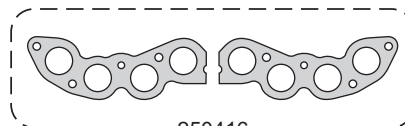

250416



250412

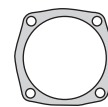

250414

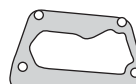

260319



250618



250625



250626



250425



250128



250428



250429



250430



250631

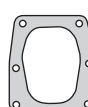

250531

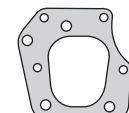

250532



250633

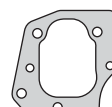

250634



250434



250435



250436



250437



250438



250439

FIAT / ALFA ROMEO

FIAT



Motor/Engine	Cm³	HP	Ø
138C3	1498	75/85	86.4
831B1	1498	82/85	86.4

Fiat: 128 Regatta '85 - Ritmo1986/90
 Duna - Uno - Super Europa 1983/...
 Elba - Premio - Fiorino

Lancia: Delta - Prisma 1986/...



Nº OE	Descripción/Description	Mat.	Ref.
	Retén distribución 40 x 56 x 7	P	1 R250412P
	Retén árbol de levas 30 x 52 x 7	P	2 R250413P

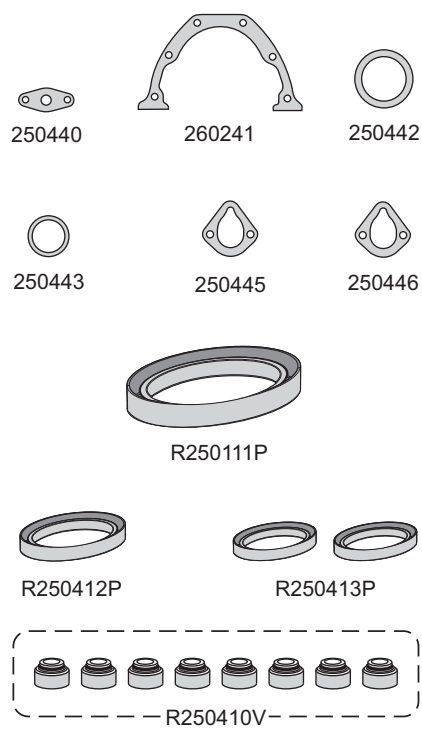

FIAT / ALFA ROMEO

FIAT



Motor/Engine Cm³ HP Ø

125AB - 125A 1608 110 80

Fiat: 125 (Bialbero) - Berlina - Sport
Multicarga - Mirafiori 1972/74



Nº OE	Descripción/Description	Mat.		Ref.
	Jgo. de juntas para motor			250700-R
	Jgo. de juntas superior		●	250795
4315063	Junta tapa cilindros Ø 81 ± 1.40	NFT	1	250705
4315063	Junta tapa cilindros Ø 81 ± 2.40	NFT		250706
	Jgo. tornillos tapa cilindros (HAS17038)			B250700
4158646	Conj. junta tapa válvulas (6)	CG	2	250710
4129756	Junta para cárter	CG	1	250711
4130903	Tapa distribución	NB	1	250712
4129813	Tapa cuerpo bomba de agua	NB	1	250714
4177112	Múltiple escape	NFT	1	250716
4194060	Múltiple admisión	NFT	1	250717
4176386	Salida de escape	FCH	1	250718
4158100	Anillo bomba de agua	NB	1	250719
	Jgo. juntas carburador SOLEX PAIA 33	VS		250720
	Jgo. juntas carburador SOLEX 34 EIES	VS		250722
	Jgo. juntas carburador WEBER DCHE-20	VS		250723
4135604	Porta filtro aceite	NB	1	250727
4081258	Base bomba nafta 0.8	NB	2	250128
4130916	Porta retén delantero	NB	1	250728
4129763	Porta retén bancada trasera	NB	1	250729
4123150	Tapa árbol levas	NB	2	250730
4268806	Caballote T.V. 0.2	NB		250731
	Caballote T.V. 0.5	NB		250732
	Caballote T.V. 0.8	NB	2	250733
4129820	Soporte bomba agua	NB	1	250734
4121068	Base bomba aceite	NB	1	250735
	Cuerpo respiradero motor	CG	1	250736
4123229	Vaso nafta	CG	1	250737
4135490	Arbol levas	NB	1	250738
4184495	Termostato	GS		260039
4188704	Salida agua	NB	1	250739
	Termostato	NB		250740
	Caballote T.V. 0.8	NFT		250741
	Arandela tapa válvulas A 13 x 21 x 1.5 F	F	4	250742
	Arandela salida agua tapa cilindros	CG		250743
	Base bomba nafta 0.5	NB		250144
4123150	Tapa árbol levas 0.25	NB		250744
4123150	Tapa árbol levas 0.5	NB		250745
4123150	Tapa árbol levas 1.0	NB		250746
4081258	Base bomba nafta 1.5	NB		250248
	Jgo. juntas caja velocidades	VS		250250
	Palier	CB		250256
	Tapa diferencial	CB		250259
4129756	Junta para cárter	CGT		250760
4158646	Junta tapa válvulas	CG		250761
	Suplemento tapa cilindros	AL		250785
	Kit de retenes completo			R250700
	Jgo. retén válvulas (8)	V	1	R250410V
	Retén bancada 70 x 90 x 10	P	1	R550411P
	Retén distribución 40 x 56 x 7	P	1	R250412P
	Retén árbol levas 30 x 52 x 7	P	3	R250413P

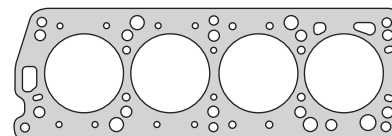

250705

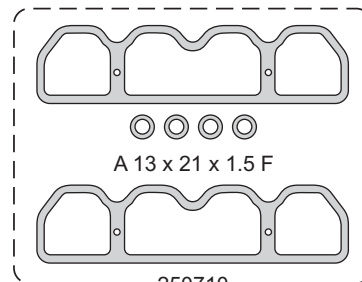

250710

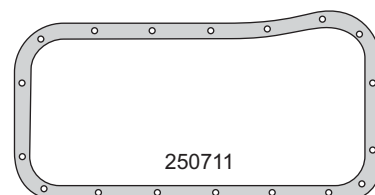

250711

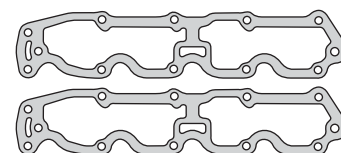

250722



250727



250716



250717

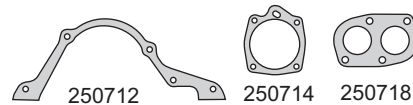

250712

250714

250718

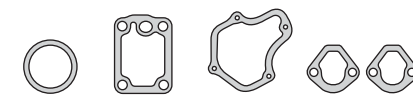

250719

250727

250728

250128

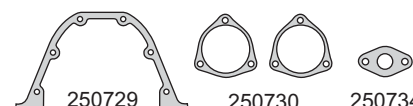

250729

250730

250734



250735

250736

250737

250738

250739



R550411P

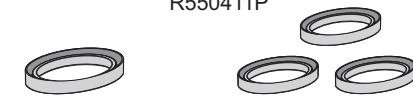

R250412P

R250413P

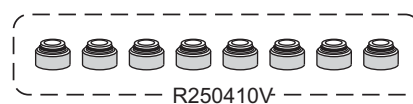

R250410V

FIAT / ALFA ROMEO

FIAT



Motor/Engine	Cm³	HP	Ø
100R	843	32	62.5
100G	843	37	65
08NCA	843	35/45	65
146A	903	40/45	65
08NCA-09NCA	903	40/45	65

Fiat: 133 - Berlina de Lujo 1977/82
850 - 850 Van 1965/76
Uno 45 1974/... - 127 Especial 1983/88

Seat: Marbella - Ibiza - Terra 1989/94 - 133 74/78
850 1964/78 - Panda 1980/...
127 - Panda 45 1972/...



Nº OE	Descripción/Description	Mat.	Ref.
	Jgo. de juntas para motor		250800-R
	Jgo. de juntas superior		250895
97051863	Junta tapa cilindros Ø 66 ± 1.40	NFT 1 1	250805
97051863	Junta tapa cilindros Ø 66 ± 2.40	NFT	250806
	Junta tapa cilindros Ø 66 ± 1.40 N.R. (HAS17038)	NFT	250807
	Jgo. tornillos tapa cilindros (HAS17038)		B250800
4117850	Junta tapa válvulas	CG 1 1	250110
	Jgo. junta para cárter (4)	CG 1	250111
4107391	Tapa distribución	NB 1	250112
97051581	Tapa bomba de agua	NB 1	250814
4127971	Múltiple admisión y escape	NFT 1 1	250816
876075	Salida de escape	FCH 1 1	250118
	Bomba de agua	NB 1	250819
	Jgo. juntas carburador WEBER 30 ICF	VS	250122
4121933	Base superior carburador	NB 1	250125
4100576	Entre carburador y múltiple	NB 1 1	250825
9910788	Tapa carburador	CB	250126
881452	Superior bomba aceite	NB 1	250127
4081258	Base bomba nafta 0,8	NB 2	250128
4052518	Brida bomba aceite	NB 1	250129
4057986	Inferior caño bomba aceite	NB 1	250130
4064079	Base intermedia carburador	NB 1	250131
883831	Base filtro aceite a block	NB 1	250133
4101760	Tapa bomba de agua	NB 1	250833
4100581	Tapa termostato	NB 1 1	250835
4172904	Porta retén bancada trasera	NB 1	250136
1/02795/60	Tapa tubo entrada aceite	CG 1	250137
987112	Balanceador armónico G101 x 4.3	GS 1	250140
4065247	Base termostato	NB 1 1	250141
	Base bomba nafta 0.5	NB	250144
4081258	Base bomba nafta 1.5	NB	250248
	Jgo. juntas caja velocidades	VS	250850
	Kit de retenes completo		R250800
	Jgo. retén válvulas (8)	P 1	R250810P
	Retén bancada 64 x 80 x 8	P 1	R250811P
	Retén distribución 42 x 56 x 7	P 1	R250112P

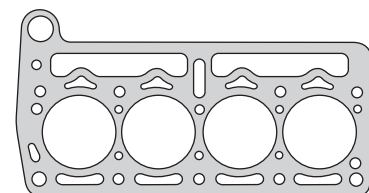

250805

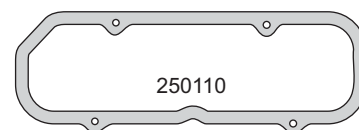

250110

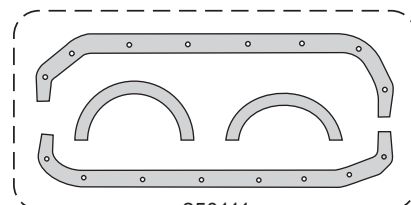

250111



250816



250112



250814



250118

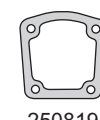

250819



250125

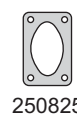

250825



250126



250127



250129



250128



250130

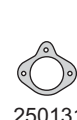

250131

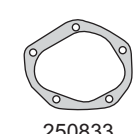

250833



250133



250835

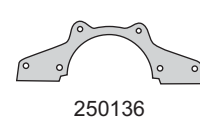

250136



250137



250140



250141



R250112P



R250811P



R250810P

FIAT / ALFA ROMEO

FIAT



Motor/Engine	Cm³	HP	Ø
149A	1585	100	84

Fiat: Regata 100S 1985/...



Nº OE	Descripción/Description	Mat.	Ref.
	Jgo. de juntas para motor		250900-R
5951675	Junta tapa cilindros Ø 85 ± 1.70	NFT 1	250905
5951675	Junta tapa cilindros Ø 85 ± 1.70	NFT	250907
5951675	Jgo. tornillos tapa cilindros (HAS17038)		B250700
	Junta tapa válvulas	CG 2	250710
4158646	Junta para cárter	CG 1	250911
4331606	Tapa distribución	NB 1	250712
4130903	Base bomba de agua	NB 1	250914
4475631	Múltiple escape	NFT 1	250716
4177112	Múltiple admisión	NFT 1	250717
4194060	Salida de escape	FCH 1	250718
1476386	Anillo caño bomba de agua	GS	250919
14458580	Jgo. juntas carburador WEBER 32-DAT	VS	250920
	Base carburador	NB 2	250925
	Tapa carburador	CB	250926
	Base bomba aceite	NB 1	250927
4304656	Porta retén delantero	NB 1	250728
4130916	Base bomba nafta	NB 2	250928
4319009	Porta retén bancada trasera	NB 1	250729
4129763	Tapa árbol levas	NB 2	250930
4123150	Caballote T.V. 0.2	NB	250731
4268806	Caballote T.V. 0.5	NB	250732
4268806	Caballote T.V. 0.8	NB 2	250733
4388512	Soporte brida caño bomba	NB 1	250734
4129820	Base filtro aceite	NB 1	250935
4337093	Pescador bomba aceite	NB 1	250937
4336939	Tapa inspección cámara agua	NB 1	250938
97053144	Salida agua	NB 1	250739
4188704	Tapa inspección cámara agua	NB 1	250940
	Base bomba agua	NB 1	250941
	Arandela tapa válvulas A 13 x 21 x 1.5 F	F 4	250742
	Filtro lubricación	NB 1	250942
4158100	Bomba agua reforma	NB 1	250943
	O´ring G 36 x 3	GS 1	
	Kit de retenes completo		R260400
	Jgo. retén válvulas (8)	V 1	R250410V
	Retén bancada 74 x 90 x 10	P 1	R260111P
	Retén distribución 30 x 43 x 8	P 1	R260112P
	Retén árbol levas 30 x 52 x 7	P 2	R250413P

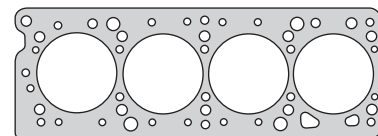

250905

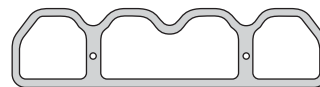

250710

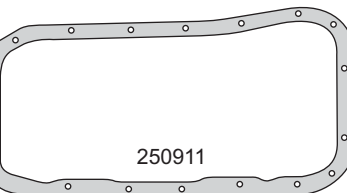

250911



250733



250716



250717

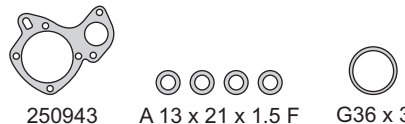
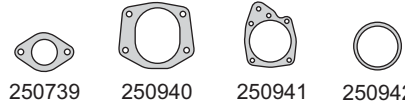
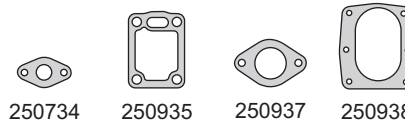
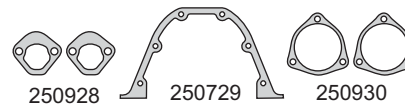
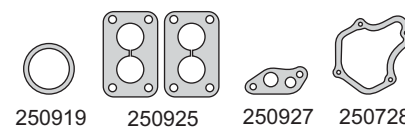
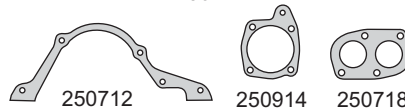

R260111P



R260112P



R250413P

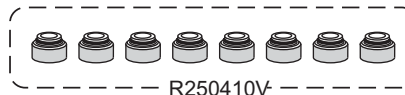

R250410V

FIAT / ALFA ROMEO

FIAT



Motor/Engine	Cm³	HP	Ø
146A2	999	30/45	70
156A2/A3	999	30/45	70
176B2/178B9	1108	54	70

Fiat: Panda 1986/... - Uno 1989/95
 Uno 1998/... - Panda 1995/96
 Palio 2001/....



N° OE	Descripción/Description	Mat.	Ref.
	Jgo. de juntas superior		251095-R
	Junta tapa cilindros Ø 71.5 ±1.20	NFT	1 270507
46546120	Junta tapa cilindros Ø 72 ±1.95	NFT	270507-1.9
	Junta tapa cilindros Ø 72 ±0.35	MLS	270508
	Jgo. tornillos tapa cilindros (HAS13038)		B270500
	Junta tapa de válvulas	P	1 251010
46546134	Jgo. múltiple escape (2)	NFT	1 270515
	Jgo. múltiple admisión	NB	1 251017
7604488	Termostato	NB	1 270519
7581344	Jgo. retén válvulas (8)	V	1 R270510V
40004240	Retén árbol de levas 30 x 42 x 7	V	1 R260113V

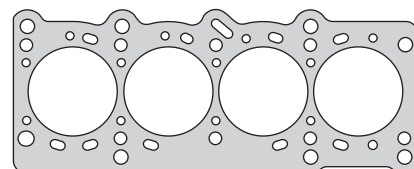

270507



251010

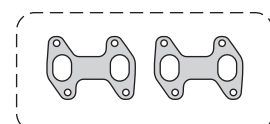

270515



251017



270519



R260113V



R270510V

FIAT / ALFA ROMEO

FIAT



Motor/Engine	Cm³	HP	Ø
8140.63 Iny. Indirecta	2799	87/89	94.4

Fiat: Ducato 14 - Ducato 18 Maxi
Ducato 14D - Ducato 18D Maxi 1998/...

Iveco: Daily 30.8 - Daily 35.8 1996/...

DIESEL



Nº OE	Descripción/Description	Mat.	Ref.
	Jgo. de juntas para motor		251100-R
500206171	Junta tapa cilindros Ø 96 ± 1.70	NFT	1 251107
	Jgo. tornillos tapa cilindros (HAS17038)		B251100
500388381	Junta tapa válvulas	N	1 251110
99488483	Junta para cárter 1996/...	CG	1 270111
99488486	Junta para cárter 1998/...	CG	1 270311
	Junta distribución	NB	1 270112
	Bomba de agua	NB	1 251114
98434020	Jgo. múltiple escape (4)	NFT	1 270116
98425767	Jgo. multiple admisión (4)	NFT	1 270117
	Porta termostato	NB	1 270119
	Comando bomba inyectora	NB	2 270135
	Junta base filtro aceite	NB	1 270136
	Brida agua	NB	1 270137
99432807	Intermedio block izquierdo	GS	1 270338
99432808	Intermedio block derecho	GS	1 270339
	Tapa inspección block trasero	NB	1 270340
	Múltiple admisión	NB	1 270341
	Base depresora	NB	1 251143
	Junta	NB	1 251144
	Tapa ciega inspección precámara	SLS	1 251142
	Bridas turbo	AC	3 251145
	Junta porta retén árbol de levas	NFT	251146
	Guarnición termostato	GS	1 460245
	Salida de escape turbo	AC	1 500546
	O´ring G 37.47 x 5.33	GS	1
	O´ring G 12.37 x 2.62	GS	1
	O´ring G 64.77 x 2.62	GS	1
	O´ring G 59.92 x 3.53	GS	1
	O´ring G 55.25 x 2.62	GS	1
	O´ring G 47.22 x 3.53	GS	2
	O´ring G 44.04 x 3.53	GS	1
	O´ring G 29.82 x 2.62	GS	1
	O´ring G 18.72 x 2.62	GS	2
	O´ring G 56.87 x 1.78	GS	1
	O´ring G 48.90 x 2.62	GS	1
	O´ring G 23.47 x 2.62	GS	1
	O´ring G 21.95 x 1.78	GS	1
	O´ring G 18.64 x 3.53	GS	1
	O´ring G 17.17 x 1.78	GS	4
	O´ring G 9.25 x 1.78	GS	4
	Arandela A 22 x 27 x 1.5 C	CU	2
	Arandela A 20 x 26 x 1 C	CU	2
	Arandela A 18 x 22 x 1.5 C	CU	2
	Arandela A 14 x 20 x 1.5 C	CU	2
	Arandela A 12 x 18 x 1.5 C	CU	10
	Arandela A 10 x 14 x 1 C	CU	4
	Arandela A 8 x 14 x 1 C	CU	5
90486686	Jgo. retén válvulas (8)	V	1 R270110V
	Porta retén bancada 1996/...	V	PR270111-1V
	Porta retén distribución 1996/...	V	PR270112-1V
	Retén árbol de levas 50 x 70 x 10	V	1 R270113V
98454041	Retén auxiliar 55 x 70 x 10	V	1 R270115V

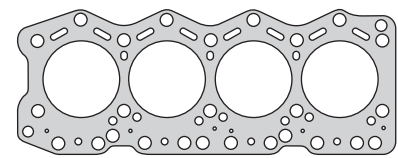

251107

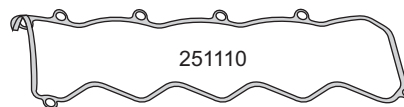

251110

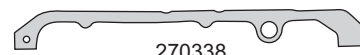

270338



270339

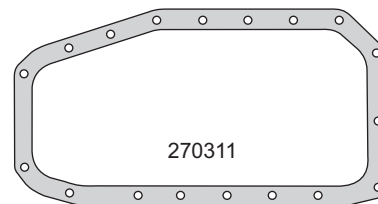

270311

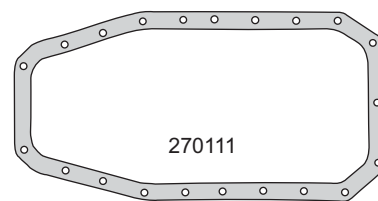

270111

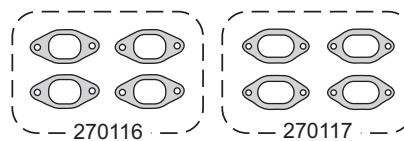

270116

270117

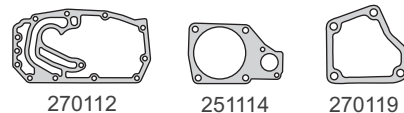

270112

251114

270119

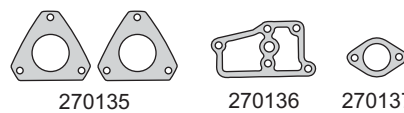

270135

270136

270137

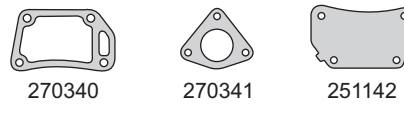

270340

270341

251142

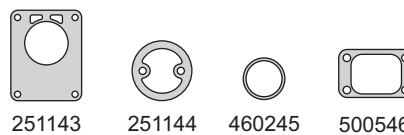

251143

251144

460245

500546



251145

251146

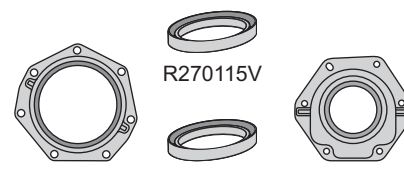

R270115V

PR270111-1V

R270113V

PR270112-1V

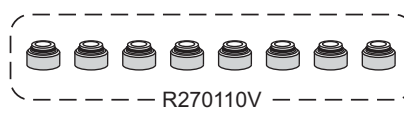

R270110V

FIAT / ALFA ROMEO

FIAT



Motor/Engine	Cm³	HP	Ø
8140.21	2445	92	93
8140.27	2499	103	93

Fiat: Ducato TD 1985/...
Iveco: Daily TD 1985/89
Renault: B90 1986/88

DIESEL



Nº OE	Descripción/Description	Mat.	Ref.
	Jgo. de juntas superior		251495-R
	Junta tapa cilindros Ø 95 \pm 1.40	NFT	1 251407
	Jgo. tornillos tapa cilindros (HAS17038)		B270100
	Junta tapa válvulas	GS	1 270110
	Jgo. múltiple admisión y escape (4)	NFT	1 270116
	Jgo. múltiple admisión (4)	NFT	1 270117
	Junta porta termostato	NB	1 270119
	Junta filtro aceite	NB	1 270132
	Junta brida agua	NB	4 270137
	Junta brida agua	NB	1 270140
	Junta brida agua	NB	1 270141
	Junta brida agua	NB	1 270142
	Junta brida agua	NB	1 270144
	Junta porta árbol de levas	NFT	251146
	Junta motor	NB	1 251445
	Junta motor	AC	1 251446
	Junta colector escape a turbo	AC	1 350462
	Arandela A 12 x 18 x 1C	CU	4
	Arandela A 8 x 14 x 0.5 C	CU	6
	Retén árbol auxiliar 55 x 70 x 10	V	1 R270115V

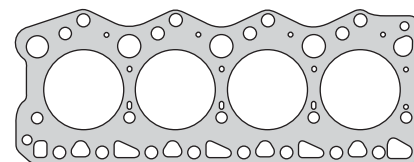

251407

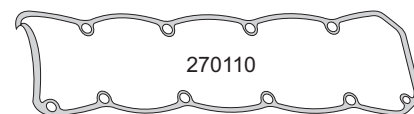

270110

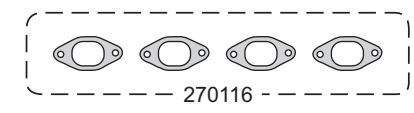

270116

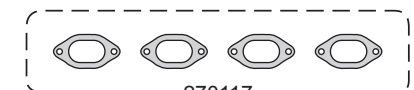

270117



270119



270132



270140



270137

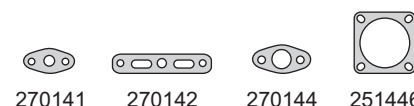

270141

270142

270144

251446



350462



251445



251146



A 12 x 18 x 1 C



A 8 x 14 x 0.5 C



R270115V

FIAT / ALFA ROMEO

FIAT



Motor/Engine	Cm³	HP	Ø
176B1/B4/A7	1242	60	70.8
178B5	1242	73	70.8
840A3	1242	60	70.8

Iny. Monopunto y Multipunto

Fiat: Punto 60 Cabrio 1995/99
 Palio 75 - Siena 1996/...
 Punto 60 - Punto Selecta 1993/99
Lancia: Ypsilon 1996/00



Nº OE	Descripción/Description	Mat.	Ref.
	Jgo. de juntas superior		251795-R
	Junta tapa cilindros Ø 71.5 ± 1.20	NFT	270507
	Junta tapa cilindros Ø 72 ± 1.95	NFT	1 270507-1.90
46541379	Junta tapa cilindros Ø 72 ± 0.35	MLS	270508
	Jgo. tornillos tapa cilindros (HAS13038)		B270500
	Junta tapa de válvulas	P	1 251010
46546134	Jgo. múltiple escape (2)	NFT	1 270515
	Jgo. múltiple admisión	NFT	1 251717
	Salida de escape	FCH	1 270518
7604488	Termostato	NB	1 270519
	Junta bomba combustible	NB	1 251728
	O`ring G36 x 3	GS	1
7581344	Jgo. retén válvulas (8)	V	1 R270510V
40004240	Retén árbol de levas 30 x 42 x 7	P	1 R260113P

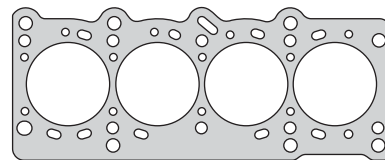

270507



251010

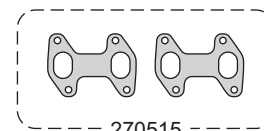

270515



251717



270519 251728 270518 G 36 x 3



R260113P



R270510V

FIAT / ALFA ROMEO

FIAT



Motor/Engine **182A7/A8** **1910** **75/100** **82**

Fiat: Brava - Bravo TD 1996/99
Marengo TD - Marea TD

DIESEL



Nº OE	Descripción/Description	Mat.	Ref.
	Jgo. de juntas para motor		252001-R
	Junta tapa cilindros Ø 83 ± 1.40	NFT	252007-SM
	Junta tapa cilindros Ø 83 ± 1.50	NFT	252007-1M
	Junta tapa cilindros Ø 83 ± 1.60	NFT	252007-2M
46473174	Junta tapa cilindros Ø 83 ± 1.35	MLS	252008-SM
46473175	Junta tapa cilindros Ø 83 ± 1.45	MLS	252008-1M
46473176	Junta tapa cilindros Ø 83 ± 1.55	MLS	252008-2M
	Jgo. tornillos tapa cilindros (HAR12063)		B252000
	Sellador líquido - caucho de silicona		TRN0280R
46432087	Junta tapa válvulas	GS 1	252010
	Frente distribución	NB 1	270612
46467747	Múltiple escape	AC 1	252015
46461755	Múltiple admisión	NFT 1	252017
	Junta brida	NFT	252029
	Guarnición goma llenado aceite	GS 1	270929
	Junta acople	NFT	252031
	Junta	SLS 1	251832
	Arandela pico inyector	AC	252033
	Salida admisión	SLS 1	270633
	Base bomba inyectora	NFT 1	251834
	Guarnición tubo goma	GS	252034
	Anillo goma G 66 x 72 x 3	GS 1	252035
	O´ring G 63.09 x 3.53	GS 1	
	O´ring G 80 x 1.80	GS 1	
	O´ring G 56.82 x 2.62	GS 1	
	O´ring G 55.25 x 2.62	GS 1	
	O´ring G 7.65 x 1.78	GS 2	
	Kit de retenes completo		R252000
7553637	Jgo. retén válvulas (8)	V 1	R250410V
46435513	Porta retén bancada 93 x 172/139 x 7/12	V	PR252011V
7628850	Retén distribución 31 x 41 x 7	V 1	R252012V
40004240	Retén árbol de levas 30 x 42 x 7	V 1	R260113V

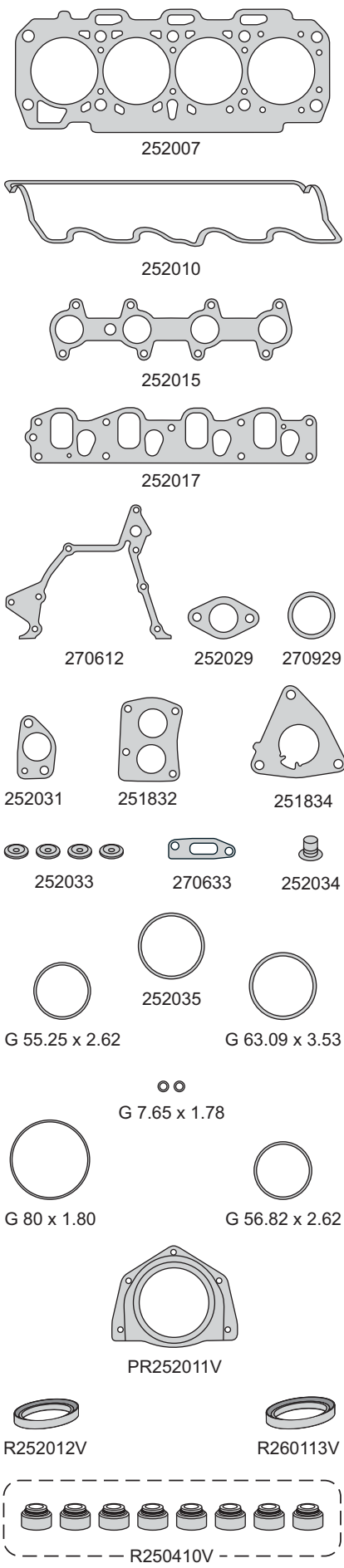

FIAT / ALFA ROMEO

FIAT



Motor/Engine	Cm³	HP	Ø
182B4	1910	105	82
323.02	1910	105	82

Fiat: Brava - Bravo TD - Multipla TD
Marea TD 1998/...

Alfa Romeo: 156 TD 1997/00 - 145 TD
146 TD 1999/...

DIESEL



Nº OE	Descripción/Description	Mat.	Ref.
	Jgo. de juntas para motor		252101-R
	Junta tapa cilindros Ø 83 \pm 1.60	NFT	252107-SM
	Junta tapa cilindros Ø 83 \pm 1.70	NFT	252107-1M
	Junta tapa cilindros Ø 83 \pm 1.80	NFT	252107-2M
46447765	Junta tapa cilindros Ø 83 \pm 1.60	MLS	252108-SM
464439944	Junta tapa cilindros Ø 83 \pm 1.70	MLS	252108-1M
46449945	Junta tapa cilindros Ø 83 \pm 1.80	MLS	252108-2M
	Jgo. tornillos tapa cilindros (HAR12063)		B252000
	Sellador líquido - caucho de silicona		TRN0280R
	Junta tapa válvulas	GS 1	252110
	Frente distribución	NB 1	270612
46467747	Múltiple escape	AC 1	252015
46772389	Múltiple admisión	NFT 1	252117
	Junta brida	NFT 1	252029
	Guarnición goma llenado aceite	GS 1	270929
	Junta acople	NFT 1	252031
	Junta	SLS 1	251832
	Arandela pico inyector	AC 4	252033
	Salida admisión	SLS 1	270633
	Base bomba inyectora	NFT 1	251834
	Guarnición tubo goma	GS 1	252034
	Anillo goma G 66 x 72 x 3	GS 1	252035
	O ring G 63.09 x 3.53	GS 1	
	O ring G 80 x 1.80	GS 1	
	O ring G 56.82 x 2.62	GS 1	
	O ring G 55.25 x 2.62	GS 1	
	O ring G 7.65 x 1.78	GS 2	
	Kit de retenes completo		R252000
7553637	Jgo. retén válvulas (8)	V 1	R250410V
46435513	Porta retén bancada 93 x 172/139 x 7/12	V	PR252011V
7628850	Retén distribución 31 x 41 x 7	V 1	R252012V
40004240	Retén árbol de levas 30 x 42 x 7	V 1	R260113V

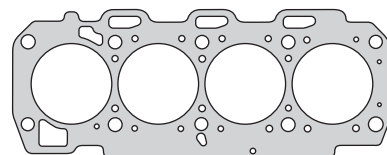

252107



252110



252015

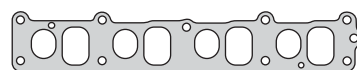

252108-SM



252108-1M



252108-2M



270612



252029



270929



252031



252033



251832



270633



251834



252034



G 55.25 x 2.62



G 66 x 72 x 3



G 80 x 1.80



G 63.09 x 3.53



G 56.82 x 2.62



G 7.65 x 1.78

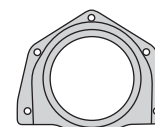

PR252011V



R252012V



R260113V



R250410V

FIAT / ALFA ROMEO

FIAT



Motor/Engine	Cm³	HP	Ø
OHC-171190	1796	103	80.5
17241C1	1796	103	80.5
G2	1796	102/105	80.5
G3	1796	110	80.5

Fiat: Palio - Stilo - Palio Flex - Strada
Siena Flex 2003/... BR
Idea Adventura HLX - G2 - G3 2006/... BR



Nº OE	Descripción/Description	Mat.	Ref.
7085016	Jgo. de juntas para motor		252300-R MLS
	Jgo. de juntas superior (MLS)		252395 MLS
7083633	Junta tapa cilindros Ø 82 ± 1.25	MLS	242208
	Jgo. tornillos tapa cilindros (HAE12038)		B240400-1
7083232	Junta tapa de válvulas	N	241010
	Junta cárter con control de compresibilidad	CG	240411
7083280	Frente motor y bomba de aceite	SLS	241812
	O´ring cierre bomba de agua G 79.5 x 3	GS	240414
93396858	Múltiple escape	AC	240415
90571863	Múltiple admisión	NB	241017
7084980	Jgo. múltiple admisión (4) G3	S	252317
73502844	Salida de escape catalizador G3	AC	252318
90128293	Salida de escape G2	FCH	240018
7084981	Junta cuerpo mariposa aceleración G3	GS	252326
7083288	Descarga gases	NB	240429
7086225	Conducto agua admisión a EGR	GS	270731
	Guarnición acople admisión G3	GS	252332
7083229	Guarnición tapa llenado de aceite G 38 x 4	GS	
	Kit de retenes completo		R252300
7083239	Jgo. retén válvulas (8) G2	V	R240210V
7083335	Jgo. retén válvulas (8) G3	V	R252310V
7084149	Retén bancada 80 x 98 x 10	V	R240411V
90280463	Retén árbol de levas 35 x 48 x 7	V	R240013V
90501719	Retén distribución 26 x 42 x 8	V	R240415V

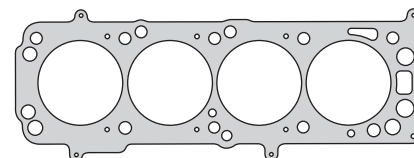

242208

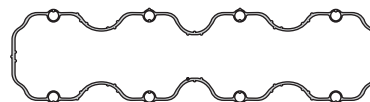

241010

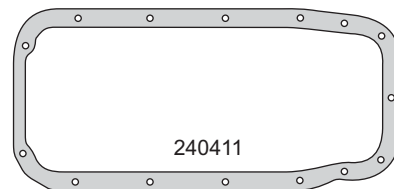

240411

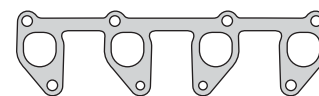

240415

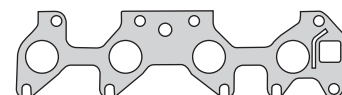

241017



252317

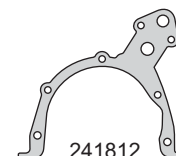

241812



240414

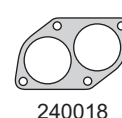

240018



252318



252326



240429



270731



252332



G 38 x 4



R240411V



R240013V



R240415V



R240210V

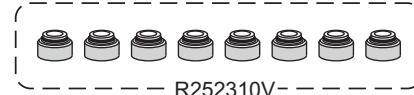

R252310V

FIAT / ALFA ROMEO

FIAT



Motor/Engine	Cm³	HP	Ø
186A6	1910	110	82
192A1/A3	1910	115	82
188B2	1910	80	82
182B9	1910	100	82

Fiat: Marea JTD 2000/02
Stilo JTD - Idea JTD - Punto 2003/...
Palio JTD 2002/... - Strada

DIESEL



Nº OE	Descripción/Description	Mat.	Ref.
1718658	Jgo. de juntas para motor		252401-R
	Jgo. de juntas superior	●	252495
	Junta tapa cilindros Ø 83 \pm 0.85	NFT	252407-SM
	Junta tapa cilindros Ø 83 \pm 1.00	NFT	252407-1M
	Junta tapa cilindros Ø 83 \pm 1.20	NFT	252407-2M
	Junta tapa cilindros Ø 83 \pm 1.30	NFT	252407-3M
55190356	Junta tapa cilindros Ø 83 \pm 0.82	MLS	252408-SM
55190357	Junta tapa cilindros Ø 83 \pm 0.92	MLS	252408-1M
55190358	Junta tapa cilindros Ø 83 \pm 1.02	MLS	252408-2M
7775920	Jgo. tornillos tapa cilindros (HAR12063)		B252000
	Sellador líquido - caucho de silicona		TRN0280R
46545441	Junta tapa válvulas	GS 1 1	252410
	Frente motor	NB 1 1	270612
46467747	Múltiple escape	AC 1 1	252015
46772389	Múltiple admisión	NFT 1 1	252117
46547895	Junta cuerpo mariposa acelerac	SLS	252426
46773082	Junta cuerpo mariposa	SLS	252428
	Guarnición goma llenado aceite	GS 1 1	270929
	Junta	SLS 1 1	251832
	Acople frente motor	SLS 1	270633
	Base bomba inyectora	NFT 1 1	251834
	Anillo goma G 66 x 72 x 3	GS 1	252036
	Arandelas pico inyector A 7 x 16 x 2 C	C 4 4	
11198074	Arandela fijación A 8 x 15 x 1.5 C	C 3 3	
	O´ring G 63.09 x 3.53	GS 1	
	O´ring G 7.65 x 1.78	GS 2	
	O´ring G 55.25 x 2.62	GS 1 1	
	O´ring G 80 x 1.80	GS 1 1	
	Kit de retenes completo		R252000
7553637	Jgo. retén válvulas (8)	V 1	R250410V
46435513	Porta retén bancada trasera	V	PR252011V
	Retén distribución 31 x 41 x 7	V 1	R252012V
6080949	Retén árbol de levas 30 x 42 x 7	V 1	R260113V

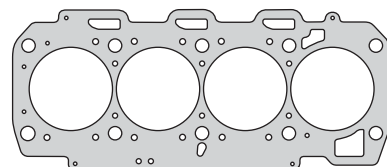

252408

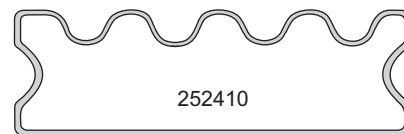

252410

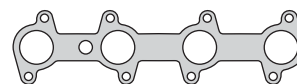

252015



252117

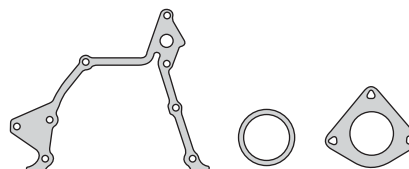

270612

270929

252426



252428



251832



270633



251834



G 80 x 1.80



G 55.25 x 2.62



G 63.09 x 3.53



G 7.65 x 1.78



A 8 x 15 x 1.5 C



A 7 x 16 x 2 C



G 66 x 72 x 3

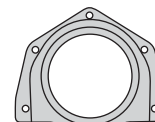

PR252011V



R260113V



R252012V



R250410V

FIAT / ALFA ROMEO

FIAT IVECO



Motor/Engine	Cm³	HP	Ø
8210.42E2 F1CE 0481 (DOHC) 16V	2998	136/155	95.8

Iveco: Daily - 40 S14 - 3.0 HPI - Euro III TD
55 C16 - 3.0 HPI - Euro III TD 2008/...

DIESEL



Nº OE	Descripción/Description	Mat.	Ref.
02995572	Jgo. de juntas para motor		252701-R
	Jgo. de juntas superior		252795
504093499	Jta. tapa cilindros Ø 96.8 ± 1.20	MLS	252708-1M
	Jta. tapa cilindros Ø 96.8 ± 1.30	MLS	252708-2M
	Jta. tapa cilindros Ø 96.8 ± 1.40	MLS	252708-3M
504047676	Junta tapa de válvulas	SLS	1 1 252710
504083813	Junta para cárter	GS	1 252711
504082437	Placa distribución	NB	1 252712
	O´ring asiento bomba de agua G 94.84 x 3.53	GS	1 252714
504167862	Jgo. múltiple escape (3)	AC	1 1 252715
504022754	Múltiple escape	GFT	1 1 252716
504047974	Múltiple admisión	SLS	1 1 252717
504072973	Salida de escape	AC	1 1 252718
504081697	Bomba aceite	SLS	1 252727
504090818	Junta posterior tapa cilin. intercambiador/calor	SLS	1 1 252728
500370706	Descarga aceite turbo	GFT	252729
504089123	Base cambiador temperatura	SLS	1 252731
504080013	Bomba de agua	SLS	1 252732
	Junta cámara trasera botadores	SLS	1 252734
504090524	Junta cuerpo regulador temperatura	SLS	1 252735
504059849	Junta tapa delantera árbol levas	GS	1 1 252736
504196620	Junta tubería colectores	SLS	252739
504196616	Junta unión pestaña a tapa	SLS	252742
504135162	Junta soporte bomba aceite	SLS	1 252743
504077555	Junta acople enfriador aceite	SLS	252744
504032165	Guarnición inyectores tapa válvula G 32 x 26 x 14	AC/P	4 4 252745
4834948	Salida de escape turbo	AC	1 1 270345
17290481	O´ring soporte trasero G 69.44 x 3.53	GS	2 252746
4834948	Junta entrada turbo	AC	1 1 500546
	Jgo. juntas turbo (3)	VS	252768
	O´ring G 64 x 2	GS	1
	O´ring G 47 x 5	GS	1
	O´ring G 45.69 x 2.62	GS	1
172954800	O´ring G 37.47 x 3.53	GS	1
	O´ring G 34.59 x 2.62	GS	1
172828810	O´ring G 28.24 x 2.62	GS	4 4
	O´ring G 23.47 x 2.62	GS	1
	O´ring G 23.47 x 2.62	GS	1
	O´ring G 17.17 x 1.78	GS	1
	O´ring G 9 x 2	GS	2
	O´ring G 6 x 2	GS	1
16508560	Arandela tapa de cilindro A 26 x 32 x 1.50 C	CU	1
	Arandela tapón cárter A 22 x 28 x 1.50 C	CU	1
	Arandela A 20 x 26 x 1 C	CU	1
	Arandela A 17 x 21 x 1.50 C	CU	1
	Arandela A 14 x 20 x 1.50 C	CU	1
	Arandela A 12 x 18 x 1.50 C	CU	6
	Arandela A 10 x 14 x 1 C	CU	1
	Kit de retenes completo		R252700
500395378	Jgo. retén válvulas (16)	V	1 R252710V
504014232	Retén trasero bancada 90 x 120 x 15.65	V	1 R252711V
504056152	Retén delantero distribución 50 x 70 x 11	V	1 R252712V
504050244	Retén respiradero motor 31 x 44.5 x 7	V	1 R252715V

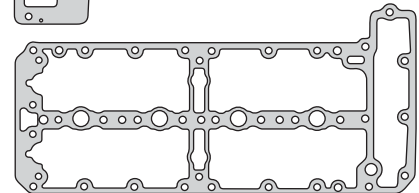
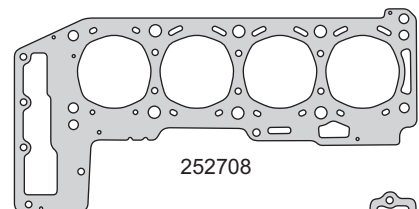

252710

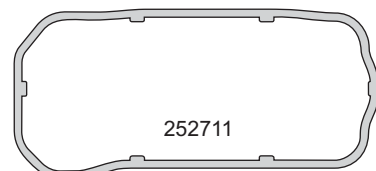

252711

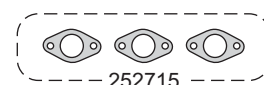

252715

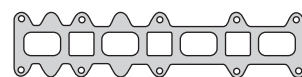

252716

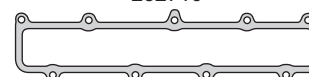

252717

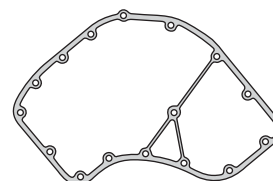

252712

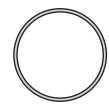

252714



252718



252727



252728



252731



252732



252734



252735

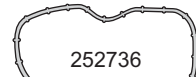

252736



252739



252743



252742

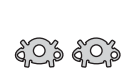

252744



252745



270345



500546

252768

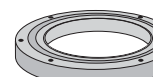

R252711V



R252712V



R252715V

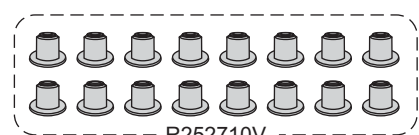

R252710V

FIAT



Motor/Engine	Cm³	HP	Ø
F1AE (DOHC) 16V	2286	110/120 127	88

Fiat: Ducato JTD 2002/... - 2006/...
Iveco: Cargo - Maxicargo - Furgon - Multijet 2010/...

DIESEL



Nº OE	Descripción/Description	Mat.	Ref.
	Jgo. de juntas para motor		252801-R
500387067	Junta tapa cilindros Ø 89 ± 1.10	MLS	252808-1M
500387068	Junta tapa cilindros Ø 89 ± 1.20	MLS	252808-2M
500387069	Junta tapa cilindros Ø 89 ± 1.30	MLS	252808-3M
	Junta tapa válvulas	AC/GS	252810
504018307	Junta para cárter	GS	252811
504012746	Junta distribución	SLS	252812
	O´ring asiento bomba de agua G 94.84 x 3.53	GS	252714
504022754	Múltiple escape	GFT	252816
504037859	Múltiple admisión	SLS	252817
500370706	Junta descarga aceite turbo	GFT	252729
	Junta	GS	252836
	Junta acople árbol de levas	GS	252837
500326581	Bridas turbo	AC	251145
504032165	Guarnición inyectores tapa válvula G 32 x 26 x 14	AC/P	252745
4834948	Junta escape turbo	AC	270345
500378462	Junta acople turbo	AC	252846
	O´ring G 63.27 x 3.53	GS	
	O´ring G 37.47 x 5.33	GS	
	O´ring G 36.17 x 2.62	GS	
	O´ring G 28.17 x 3.53	GS	
	O´ring G 23.52 x 1.78	GS	
	O´ring G 21.82 x 3.53	GS	
	O´ring G 9.19 x 1.78	GS	4
	O´ring G 6 x 2	GS	1
	O´ring G 52.07 x 2.62	GS	1
	O´ring G 32.69 x 5.33	GS	1
	O´ring G 32.09 x 2.62	GS	1
	O´ring G 45.69 x 2.62	GS	1
	O´ring G 7.65 x 1.78	GS	1
	O´ring G 80 x 88 x 5	V	1
	Arandela A 20 x 26 x 1 C	CU	1
	Arandela A 17 x 21 x 1.5 C	CU	2
	Arandela A 12 x 18 x 1 C	CU	3
	Arandela A 12 x 17 x 1.5 C	CU	8
	Arandela A 10 x 14 x 1 C	CU	2
	Arandela A 18 x 22 x 1C	CU	1
	Arandela A 6 x 9 x 1 A	AL	1
	Kit de retenes completo		R252700
500395378	Jgo. retén válvulas (16)	V	R252710V
504014232	Retén trasero bancada 90 x 120 x 15.65	V	R252711V
504056152	Retén delantero distribución 50 x 70 x 11	V	R252712V
504050244	Retén respiradero motor 31 x 44.5 x 7	V	R252715V

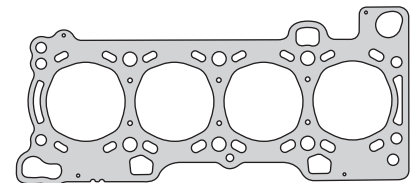

252808

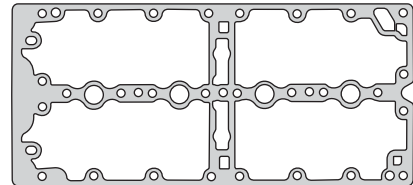

252810



252811

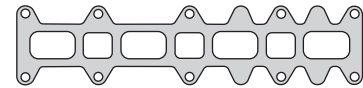

252816

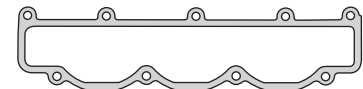

252817

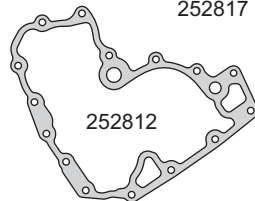

252812



252714



252836

252729

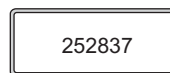

252837



252745



270345



252846



251145



A 12 x 17 x 1.5 C



A 12 x 18 x 1 C



A 17 x 21 x 1.5 C



A 10 x 14 x 1 C



A 18 x 22 x 1 C



A 6 x 9 x 1 A

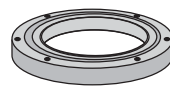

R252711V



R252712V

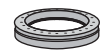

R252715V

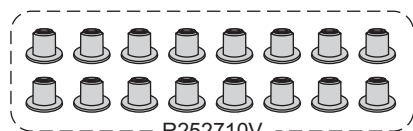

R252710V

FIAT / ALFA ROMEO

FIAT IVECO



Motor/Engine	Cm³	HP	Ø
8140.43 Euro II 8140.43S Euro III Common Rail	2798	122/125	94.4

Fiat: Ducato JTD 2006/09
Iveco: Daily 35.13 - 35.13 4x4 - 38.13 - 40.13
 50.13 - 60.13 - 70.13 2005/10
Peugeot: Boxer TDI/HDI 2001/09
Renault: Jumper HDI 2001/09

DIESEL



Nº OE	Descripción/Description	Mat.	Ref.
	Jgo. de juntas para motor		252901-R
99432354	Junta tapa cilindros Ø 96 \pm 1.30	NFT	270107-SM
99432353	Junta tapa cilindros Ø 96 \pm 1.40	NFT	270107-1M
99460983	Junta tapa cilindros Ø 96 \pm 1.50	NFT	270107-2M
99458402	Junta tapa cilindros Ø 96 \pm 1.60	NFT	270107-3M
48281505	Jgo. tornillos tapa cilindros (HAS17038)		B270100
500388381	Junta tapa válvulas	N	1 251110
99488486	Junta para cárter	CG	1 270311
	Frente distribución	NB	1 270112
98434020	Jgo. múltiple escape (4)	NFT	1 270116
98425767	Jgo. múltiple admisión (4)	NFT	1 270117
98421297	Porta termostato	NB	1 270119
	Bomba vacío	NB	1 270131
	Filtro aceite	NB	1 270132
98430444	Comando bomba inyectora	NB	1 270135
	Junta base filtro aceite	NB	1 270136
98430478	Brida agua	NB	1 270137
99432807	Intermedio block izquierdo esp. 2.5	GS	1 270338
	Anillo termostato	GS	1 330638
99432808	Intermedio block derecho esp. 2.5	GS	1 270339
	Tapa inspección block trasera	NB	1 270340
98426170	Colector admisión	NB	1 270341
98484659	Colector a turbo	AC	1 270345
	Guarnición termostato	GS	1 460245
99436990	Escape a turbo	AC	1 270347
	Salida aceite a turbo	NB	1 271147
	O'ring G 9.25 x 1.78	GS	4
	O'ring G 13.11 x 2.62	GS	1
	O'ring G 17.17 x 1.78	GS	6
	O'ring G 18.64 x 3.53	GS	1
	O'ring G 21.89 x 2.62	GS	1
	O'ring G 22.2 x 3.5	GS	2
	O'ring G 23.47 x 2.62	GS	1
	O'ring G 28.24 x 2.62	GS	1
	O'ring G 29.82 x 2.62	GS	1
	O'ring G 39.34 x 2.62	GS	1
	O'ring G 44.04 x 3.53	GS	1
	O'ring G 47.22 x 3.53	GS	3
	O'ring G 48.90 x 2.62	GS	2
	O'ring G 55.25 x 2.62	GS	1
	O'ring G 56.87 x 1.78	GS	1
	O'ring G 59.92 x 3.53	GS	1
	O'ring G 64.77 x 2.62	GS	1
	O'ring G 94.84 x 3.53	GS	1
	O'ring G 98.02 x 3.53	GS	1
	Arandela A 7 x 13 x 1.5 A	AL	1
	Arandela A 8 x 14 x 1 C	CU	5
4858606	Arandela A 10 x 14 x 1 C	CU	6
	Arandela A 12 x 16 x 1.5 C	CU	1
4858607	Arandela A 12 x 17 x 1.5 C	CU	5
	Arandela A 12 x 18 x 1.5 C	CU	1
4858608	Arandela A 14 x 20 x 1.5 C	CU	10
	Arandela A 16 x 20 x 1 C	CU	4

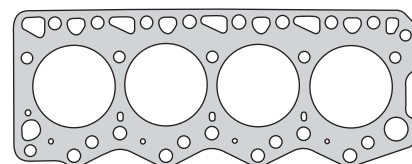

270107

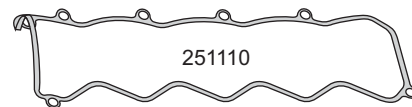

251110

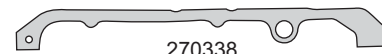

270338

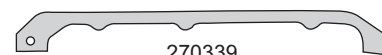

270339

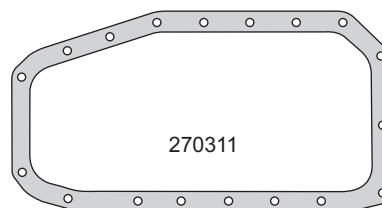

270311

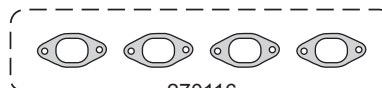

270116

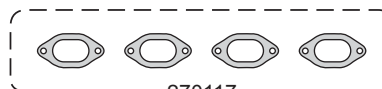

270117

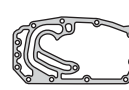

270112



270119

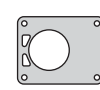

270131



270132

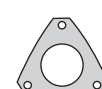

270135



270136



270137

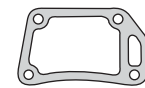

270340



270341



270345



460245



270347



271147



G 94.84 x 3.53



330638



G 98.02 x 3.53



G 47.22 x 3.53



G 55.25 x 2.62



G 64.77 x 2.62



G 56.87 x 1.78



G 59.92 x 3.53



G 39.34 x 2.62

FIAT IVECO



Motor/Engine	Cm³	HP	Ø
8140.43 Euro II 8140.43S Euro III Common Rail	2798	122/125	94.4

Fiat: Ducato JTD 2006/09
Iveco: Daily 35.13 - 35.13 4x4 - 38.13 - 40.13
 50.13 - 60.13 - 70.13 2005/10
Peugeot: Boxer TDI/HDI 2001/09
Renault: Jumper HDI 2001/09

DIESEL



Nº OE	Descripción/Description	Mat.	Ref.
	Arandela A 18 x 22 x 1.5 C	CU	1
	Arandela A 20 x 26 x 1 C	CU	2
	Arandela A 22 x 27 x 1.5 C	CU	1
	Kit de retenes completo		R251100
98472291	Jgo. retén válvulas (8)	V	1 R270110V
99468744	Porta retén bancada 1996/...	V	PR270111-1V
	Porta retén distribución 1996/...	V	PR270112-1V
98454045	Retén árbol levas 50 x 70 x 10	V	1 R270113V
98454041	Retén auxiliar 55 x 70 x 10	V	1 R270115V

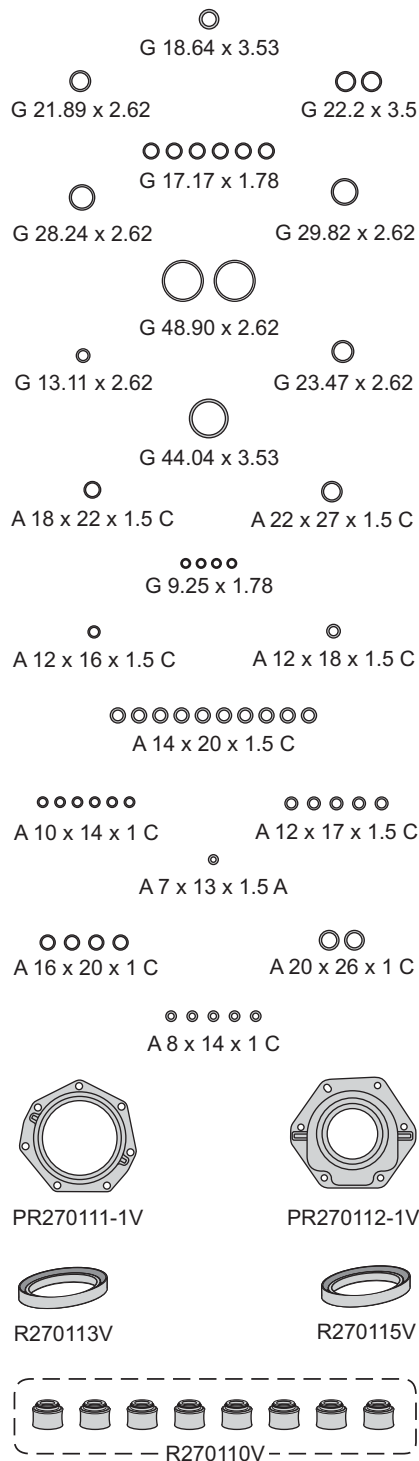

FIAT / ALFA ROMEO

FIAT



Motor/Engine	Cm³	HP	Ø
4TD - 146B	1301	45	76.1

Fiat: 147 - Duna - Fiorino - Spazio - Uno 1985/...

DIESEL



Nº OE	Descripción/Description	Mat.	Ref.
5881359	Jgo. de juntas para motor		260001-R
	Jgo. de juntas superior	●	260095-SM
	Jgo. de juntas superior		260095-1M
	Jgo. de juntas superior		260095-2M
	Jgo. de juntas superior		260095-3M
4467996	Junta tapa cilindros Ø 77 \pm 1.65	NFT	1 260007-SM
4467997	Junta tapa cilindros Ø 77 \pm 1.80	NFT	260007-1M
4467998	Junta tapa cilindros Ø 77 \pm 1.95	NFT	260007-2M
	Junta tapa cilindros Ø 77 \pm 2.20	NFT	260007-3M
	Jgo. tornillos t/cilin. (HAS13038/HAS17038)		B260000
4424154	Junta tapa válvulas superior	NB	1 1 260010
4249510	Junta para cárter	CG	1 260011
4249516	Tapa distribución	CB	1 260012
4249517	Placa distribución	NB	1 260013
4346415	Cuerpo bomba de agua	NB	1 1 260014
4398359	Jgo. múltiple admisión y escape (2)	NFT	1 1 260016
	Salida de escape	FCH	1 1 260018
4250780	Base bomba de agua	CB	1 1 260019
4250500	Cuerpo bomba aceite	CB	1 260027
4193959	Superior bomba de agua	NB	1 1 250429
4296113	Tapa cámara agua	NB	1 1 260029
4249520	Tapa árbol levas	NB	1 1 260030
4386806	Tapa block lado placa	CB	1 260033
4477229	Tapa block lado volante	CB	1 260034
4434100	Colector aspiración	NB	1 260035
	Arandela parallamas	AC	4 560036
4193959	Entre bomba agua y tubo	NB	260037
4109133	Tapón orificio distribución	NB	1 260038
4184495	Termostato	GS	1 1 260039
5948368	Tapa bomba agua	NB	1 1 260040
4351195	Base termostato	NB	1 1 260041
4325360	Tapa retén aceite	NB	1 1 260042
	Bomba depresora	NB	1 1 260043
4249510	Junta para cárter	CGT	260060
	O'ring depresora G 39.34 x 2.62	GS	
	O'ring depresora G 5.34 x 1.78	GS	
	Kit de retenes completo		R260000
	Jgo. retén válvulas (8)	V	1 R250410V
	Retén bancada 70 x 85 x 8	P	1 R260011P
	Retén distribución 40 x 56 x 7	P	1 R250412P
	Retén árbol levas 30 x 52 x 7	P	2 R250413P

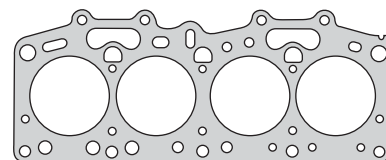

260007

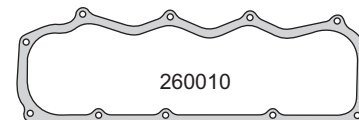

260010

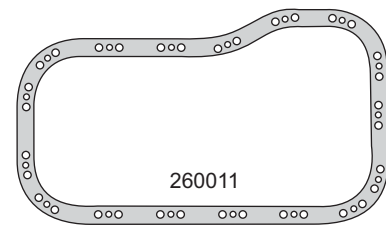

260011

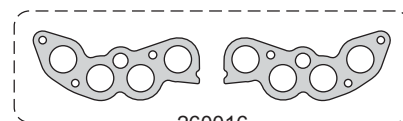

260016

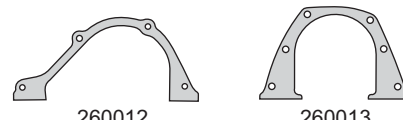

260012

260013

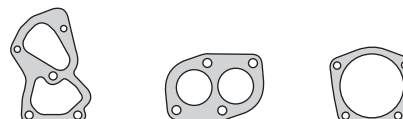

260014

260018

260019

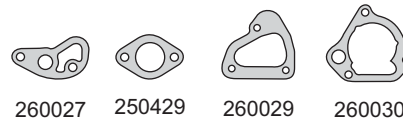

260027

250429

260029

260030

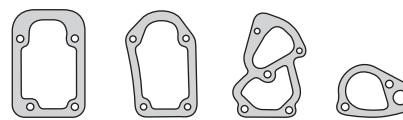

260033

260034

260040

260035

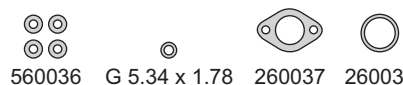

560036

G 5.34 x 1.78

260037

260038

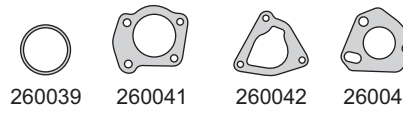

260039

260041

260042

260043



G 39.34 x 2.62



R260011P



R250412P

R250413P

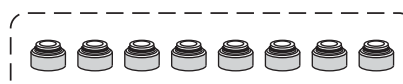

R250410V

FIAT / ALFA ROMEO

FIAT



Motor/Engine	Cm³	HP	Ø
835C	1756	90/105	84
836A	1756	90/101	84
154C	1987	90/110	84
831C	1995	177	84
834B	1995	115	84

Fiat: Regatta 2000 - Bialbero - Tempra 1989/...
Tempra - Tipo 1992/95
Lancia: Delta - Dedra 1993/99
Thema - Delta Turbo 1987/94



Nº OE	Descripción/Description	Mat.	Ref.
	Jgo. de juntas para motor		260100-R
7604263	Junta tapa cilindros Ø 85 ±1.70	NFT 1	260105
5959226	Junta tapa cilindros Ø 85 ±1.70	NFT	260107
	Jgo. tornillos tapa cilindros (HAR10168)		B260100
7574967	Conj. junta tapa válvulas (6)	NB 2	260110
	Junta para cárter	CG 1	260111
7589509	Tapa distribución	NB 1	260112
4475631	Bomba de agua	NB 1	250914
4177112	Múltiple escape	NFT 1	250716
7546474	Múltiple admisión	NFT 1	260117
4176386	Salida de escape	FCH 1	250718
5949822	Termostato	GS	250919
	Jgo. juntas carburador WEBER 34 DMTR	VS	260120
97053371	Base carburador	NB 2	260125
4161222	Tapa carga aceite	GS 1	260129
4129763	Porta retén bancada trasera	NB 1	250729
7547667	Inspección árbol levas	NB 2	260130
5966008	Caballote T.V.	NFT 2	260131
4337093	Filtro aceite	NB 1	250935
5969318	Aspirador bomba aceite	NB 1	260137
5960717	Inspección agua a block	NB 1	260138
5873131	Tubo respiración	NB 1	260139
7541231	Tapa base termostato	NB 1	260140
5923392	Inferior base termostato	GS 1	260141
5972773	Cuerpo respiradero o'ring G 36 x 3	GS 1	260142
	Arandela tapa valvulas A 13 x 21 x 1.5 F	F 4	250742
4158100	Cuerpo inferior respiradero	NB 1	260143
10280060	Perilla tapa botadores A 14 x 20 x 2 C	CU 4	260144
	Kit de retenes completo		R260400
	Jgo. retén válvulas (8)	V 1	R250410V
	Retén bancada 74 x 90 x 10	P 1	R260111P
	Retén distribución 30 x 43 x 8	P 1	R260112P
	Retén árbol levas 30 x 52 x 7	P 2	R250413P

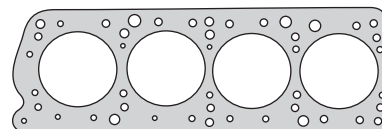

260105

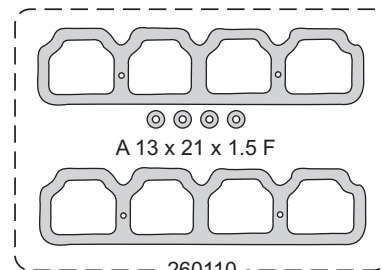

A 13 x 21 x 1.5 F

260110

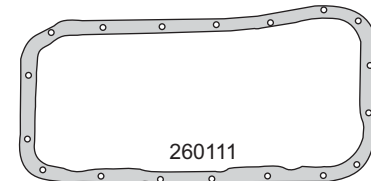

260111

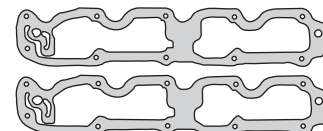

260131



250716



260117

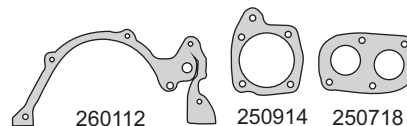

260112

250914

250718

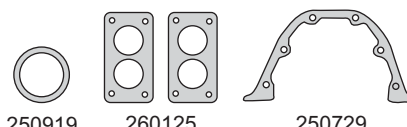

250919

260125

250729



260130

260129

250935

260137

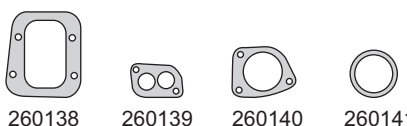

260138

260139

260140

260141

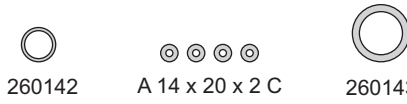

260142

A 14 x 20 x 2 C

260143



R260111P



R260112P



R250413P

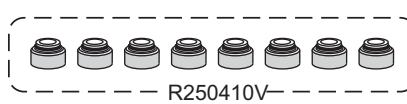

R250410V

FIAT / ALFA ROMEO

FIAT



Motor/Engine	Cm³	HP	Ø
160A1	1372	71	80.5
146C1/5	1372	67/72	80.5
159A2	1372	78	80.5

Fiat: Spazio - Duna - Tipo - Uno - Vivace
Palio - Siena 1988/91 - Fiorino 1993/95

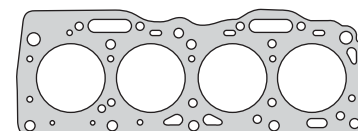

260205



260210



260310

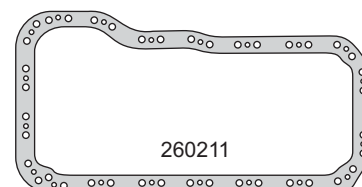

260211

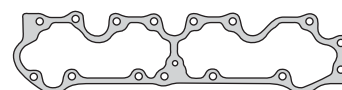

260231

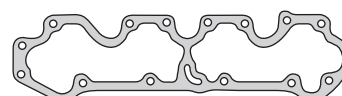

260331



260216



250412

250414

250618

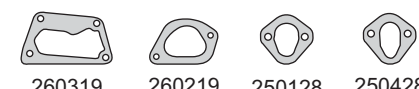

260319

260219

250128

250428

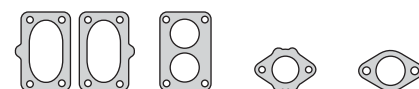

260225

260325

250425

250429



260330

250633

250634

250434

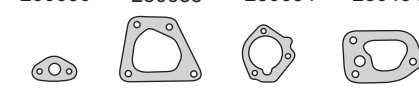

250430

260235

250435

250237



250438

250439

250440

250442



250445

250443

250446

260241



R250111P



R250412P

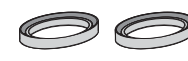

R250413P

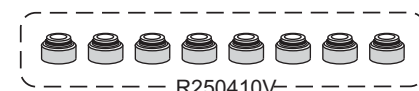

R250410V

Nº OE	Descripción/Description	Mat.	Ref.
	Jgo. de juntas para motor		260200-R
	Jgo. de juntas superior		260295
	Jgo. de juntas superior		260297
7663366	Jta. tapa cilindros Ø 81 ± 1.70	NFT 1 1	260205
	Jta. tapa cilindros Ø 81 ± 2.40	NFT	260206
7604403	Jta. tapa cilindros Ø 81 ± 1.65 N.R.	NFT	260207
	Jgo. tornillos tapa cilindros (HAS15038)		B260200
7554851	Junta tapa válvulas	CG	260210
7797034	Junta tapa válvulas 1996/...	CG 1 1	260310
	Junta tapa válvulas super medida (4.00)	CG	260310-SM
	Junta para cárter	CG	260211
4179117	Tapa distribución	NB	250412
97052378	Bomba de agua	NB	250414
7665722	Múltiple admisión y escape	NFT 1 1	260216
	Salida de escape	FCH 1 1	250618
	Acople salida de escape	FCH	260218
46584559	Termostato	NB 1 1	260219
7770023	Bomba de agua a block	NB	260319
	Jgo. juntas carburador WEBER 32/34 TLDE	VS	260220
4428157	Base carburador	NB 1 1	250425
	Base superior carburador WEBER	NB	260325
97053371	Base carburador	NB 2 2	260225
	Tapa carburador WEBER TLDE	NB	260226
4179113	Base bomba nafta 0.8	NB	250128
4205663	Separador bomba nafta 0.5	NB	250428
4193959	Superior bomba agua	NB	250429
4194902	Brida caño calefactor	NB	250430
	Base inferior carburador WEBER	NB	260330
7633424	Caballote T.V.	NB	260231
7784728	Caballote T.V. (1993/)	NB 1 1	260331
5937811	Tapa inspección block (lado volante)	NB	250633
7597760	Tapa inspección block	NB	260234
4195119	Tapa inspección cigüeñal	NB	250434
7575660	Tapa inspección block (lado dist.)	NB	250634
4179117	Tapa inspección árbol levas	NB 1 1	250435
7668667	Tapa inspección cigüeñal	NFT	260235
7615049	base termostato	NB 1 1	260237
4179148	Brida caño aceite	NB	250438
4179138	Base bomba aceite	NB	250439
4230783	Bomba aceite tubo escape	NB	250440
	Unión caño escape	AC	260240
7737202	Porta retén bancada trasera	NB	260241
4158100	Caño respiradero cárter	NB	250442
4109133	Apoyo distribuidor	NB	250443
4179114	Separador bomba nafta 0.8	NB	250445
4205664	Separador bomba nafta 1.5	NB	250446
	O´ring bomba nafta G 31. 42 x 2. 62	GS 2	260247
7663366	Junta para cárter	CGT	260260
	Kit de retenes completo		R260200
	Jgo. retén válvulas (8)	V 1	R250410V
	Retén bancada 64 x 80 x 8	P 1	R250111P
	Retén distribución 40 x 56 x 7	P 1	R250412P
	Retén árbol levas 30 x 52 x 7	P 2	R250413P

FIAT / ALFA ROMEO

FIAT



Motor/Engine	Cm³	HP	Ø
SEVEL	1581	84/88	86.4
146C6	1581	75	86.4
159A3	1581	76/86	86.4
160A2	1581	82	86.4
835A	1581	80/90	86.4

Fiat: Duna - Uno - Regatta - Palio - Siena
Premio - Elba - Tipo - Fiorino 1988/...

Lancia: Dedra 1989/93



Nº OE	Descripción/Description	Mat.	1	2	Ref.
	Jgo. de juntas para motor				260300-R
	Jgo. de juntas superior		●		260395
	Jgo. de juntas superior				260397
7604404	Jta. tapa cilindros Ø 87 \pm 1.70		NFT	1	260305
	Jta. tapa cilindros Ø 87 \pm 2.40		NFT		260306
7604404	Jta. tapa cilindros Ø 87 \pm 1.70		NFT		260307
	Jgo. tornillos tapa cilindros (HAS15038)				B260200
7554851	Junta tapa válvulas		CG		260210
7797034	Junta tapa válvulas 1996/...		CG	1	260310
7663366	Junta para cárter		CG	1	260211
4179117	Tapa distribución		NB	1	250412
97052378	Bomba de agua		NB	1	250414
7665722	Múltiple admisión y escape		NFT	1	260216
7772495	Múltiple admisión y escape		GFT		260316
	Acople salida de escape		FCH		260218
	Salida de escape		FCH	1	250618
46584559	Termostato		NB	1	260219
97052379	Bomba de agua a block		NB	1	260319
	Jgo. juntas carburador WEBER 32/34 TLDE		VS		260220
	Jgo. juntas carburador WEBER		VS		260221
	Jgo. juntas carburador WEBER TLDF		VS		260222
4428157	Junta base carburador		NB	1	250425
97053371	Junta base carburador WEBER TLDE		NB	2	260225
	Base carburador WEBER TLDE		NB	1	260325
4179113	Tapa bomba nafta 0.8		NB	1	250128
4205663	Separador bomba nafta 0.5		NB	1	250428
4193959	Superior bomba agua		NB	1	250429
	Base carburador WEBER		NB	1	260330
4194902	Brida caño calefactor		NB	1	250430
7633424	Caballote T.V.		NB		260231
7784728	Caballote T.V. 1993/...		NB	1	260331
5937811	Tapa inspección block (lado volante)		NB	1	250633
7597760	Tapa inspección block		NB		260234
7575660	Tapa inspección block (lado dist.)		NB	1	250634
4195119	Tapa inspección cigüeñal		NB	1	250434
7668667	Tapa inspección cigüeñal		NFT	1	260235
4179117	Tapa inspección árbol levas		NB	1	250435
7615049	Base termostato		NB	1	260237
4179148	Brida caño aceite		NB	1	250438
4179138	Base bomba aceite		NB	1	250439
4230783	Bomba aceite tubo escape		NB	1	250440
4302267	Porta retén bancada trasera		NB	1	260241
4158100	Caño respiradero cárter		NB	1	250442
4109133	Apoyo distribuidor		NB	1	250443
4179114	Separador bomba nafta 0.8		NB	1	250445
4205664	Separador bomba nafta 1.5		NB	1	250446
	O'ring bomba nafta G 31.42 x 2.62		GS	2	260247
7663366	Junta para cárter		CGT		260260
	Kit de retenes completo				R260200
	Jgo. retén válvulas (8)		V	1	R250410V
	Retén bancada 64 x 80 x 8		P	1	R250111P
	Retén distribución 40 x 56 x 7		P	1	R250412P
	Retén árbol levas 30 x 52 x 7		P	2	R250413P

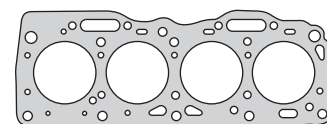

260305



260210



260310

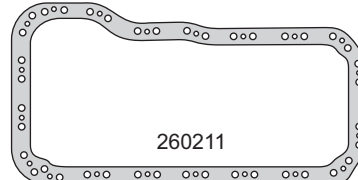

260211

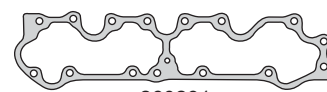

260231

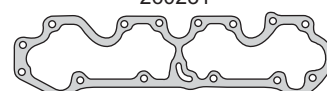

260331



260216/260316

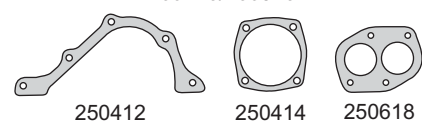

250412

250414

250618



260319

260219

250425

250128

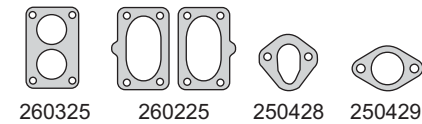

260325

260225

250428

250429

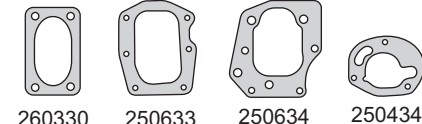

260330

250633

250634

250434

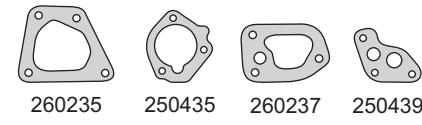

260235

250435

260237

250439



250430

250438

250440

250443

250442

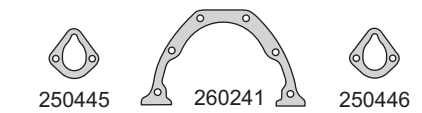

250445

260241

250446



R250111P



R250412P



R250413P

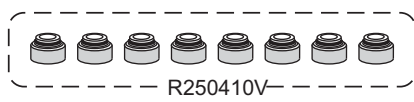

R250410V

FIAT / ALFA ROMEO

FIAT



Motor/Engine	Cm³	HP	Ø
149B - 146B 831D	1697 1929	60 65	82.6 82.6

Fiat: Duna - Uno - Regatta - Fiorino 1985/...
Lancia: Prisma 1986/91

DIESEL



Nº OE	Descripción/Description	Mat.	Ref.
	Jgo. de juntas para motor		260401-R
7759146	Jgo. de juntas superior	●	260495-SM
7759147	Jgo. de juntas superior		260495-1M
7759148	Jgo. de juntas superior		260495-2M
7759149	Jgo. de juntas superior		260495-3M
	Junta tapa cilindros Ø 84 \pm 1.70	NFT 1	260407-SM
7702774	Junta tapa cilindros Ø 84 \pm 1.80	NFT	260407-1M
7647596	Junta tapa cilindros Ø 84 \pm 1.95	NFT	260407-2M
7625508	Junta tapa cilindros Ø 84 \pm 2.20	NFT	260407-3M
	Jgo. tornillos tapa cilindros (HAR12063)		B260400
7702770	Junta tapa válvulas	NB 1 1	260410
7765454	Junta para cárter	CG 1	260411
7765454	Tapa distribución	NB 1	260112
4364121	Bomba de agua tapa DUNA/PALIO/SIENA 1.9	NB	270014
	Cuerpo bomba de agua	NB 1 1	260414
4129763	Múltiple admisión y escape turbo (NFT/CHA)	NFT	1 260415
4161222	Múltiple admisión y escape	NFT 1	260416
7702773	Bomba de agua a tapa de cilindros	NB 1 1	260419
7702766	Base filtro aceite	NB 1	260427
7702772	Porta retén bancada trasera	NB 1	250729
	Tapa carga aceite	GS 1	260129
7702131	Tapa cámara agua	NB 1 1	260429
7702769	Soporte bomba inyectora	NB 1	260430
7696793	Termostato	NB 1 1	260431
7565461	Tapa cámara agua	NB 1 1	260432
	Tapa cámara block	NB 1	260433
5969318	Tapa soporte árbol levas	NB 1 1	260434
7702768	Tapa block lado distribución	CB 1	260435
7668658	Arandela parallamas	AC 4	560036
	Bomba de agua tapa DUCATO	NB 1	260436
	Aspirador bomba aceite	NB 1	260137
	Tapa árbol levas	NB 1 1	260437
4158100	Inspección agua block	NB 1	260138
	Salida agua	CB 1	260439
10282458	Brida	NFT 2	260440
	Brida	NFT 1	260441
	Anillo caño bomba agua G36.09 x 3.53	GS 1 1	260442
	Bomba depresora	NB	260043
	Cuerpo inferior respiradero	NB 1	260143
	O'ring bomba depresora G 40.94 x 2.62	GS	260044
	Arandela conducto combust. A 25 x 29.5 x 1C	CU 4	260444
	Jgo. caja velocidades DUCATO todos	VS	270050
	O'ring bomba depresora G 5.34 x 1.78	GS	
	Kit de retenes completo		R260400
	Jgo. retén válvulas (8)	V 1	R250410V
	Retén bancada 74 x 90 x 10	P 1	R260111P
	Retén distribución 30 x 43 x 8	P 1	R260112P
	Retén árbol levas 30 x 52 x 7	P 2	R250413P

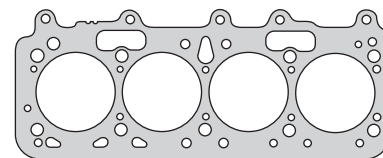

260407

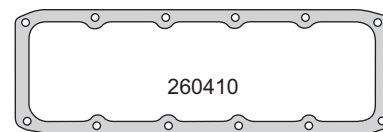

260410

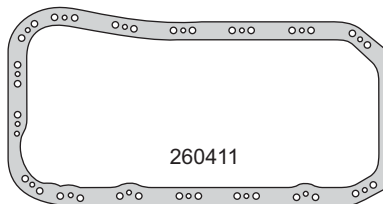

260411



260415



260112

260414

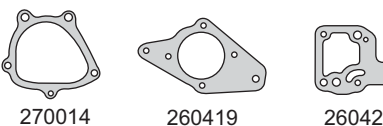

270014

260419

260427

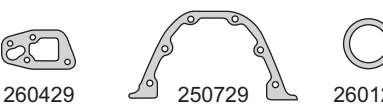

260429

250729

260129

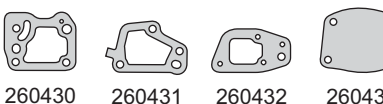

260430

260431

260432

260433

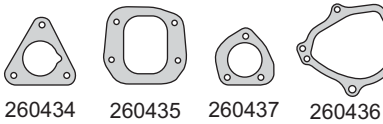

260434

260435

260437

260436

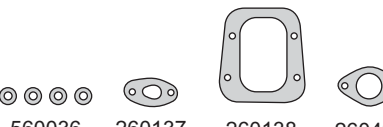

560036

260137

260138

260439

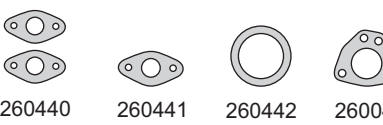

260440

260441

260442

260043



260143

A 25 x 29.5 x 1 C

260044



R260111P



R260112P

R250413P



R250410V

FIAT / ALFA ROMEO

FIAT



Motor/Engine	Cm ³	HP	Ø
127AB 206	1049	60/70	76
127AB 2C	1300	60/70	76

Fiat: 147 - Oggi - Panorama - Uno - Premio Trend



N° OE	Descripción/Description	Mat.	1	2	Ref.
7073000/418	Jgo. de juntas para motor				260500-R
	Jgo. de juntas superior		●		260595
5990020	Junta tapa cilindros Ø 77 ± 1.40	NFT	1	1	260505
	Jgo. de tornillos para tapa de cilindros				B260500
4323710	Junta tapa válvulas	CG	1	1	260510
4249510	Jgo. junta para cárter	CG		1	260011
4249516	Tapa distribución	CB		1	260012
4249517	Porta retén	NB		1	260013
4346415	Bomba de agua	NB	1	1	260014
4398359	Jgo. admisión y escape (2)	NFT	1	1	260016
	Salida de escape	FCH	1	1	260018
4250780	Bomba de agua	CB		1	260019
4206146	Base carburador	NB	1	1	250425
4250500	Aceite	CB		1	260027
4143730	Base bomba nafta	NB			250128
	Base bomba nafta (0,25)	NB		1	260528
4193959	Superior bomba de agua	NB		1	250429
4296113	Tapa delantera válvulas	NB	1	1	260029
	Base bomba nafta (0,80)	NB		1	260529
4249520	Tapa árbol levas	NB		1	260030
	Base bomba nafta (1,20)	NB		1	260530
	Junta tapa válvulas	NB			260531
4386806	Tapa block lado	CB		1	260033
4386808	Tapa block lado volante	CB		1	260034
4346834	Tensor de correa	NB		1	260534
4346836	Colector aspiración	NB		1	260035
4346833	Tapón block a volante	NB		1	260535
4427495	Respiradero motor	NB		1	260536
4193959	Entre bomba y tubo	NB			260037
4109133	Tapón orificio distribución	NB		1	260038
	Junta termostato	GS		1	260039
4351195	Base termostato	NB	1	1	260041
4325360	Tapa retén aceite	NB	1	1	260042
	Base bomba nafta	NB		1	250144
	Kit de retenes completo				R260000
	Jgo. retén válvulas (8)	V		1	R250410V
	Retén bancada 70 x 85 x 8	P		1	R260011P
	Retén distribución 40 x 56 x 7	P		1	R250412P
	Retén árbol de levas 30 x 52 x 7	P		2	R250413P

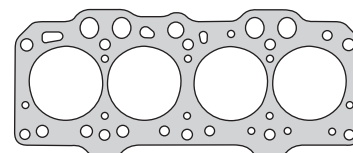

260505

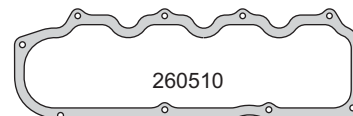

260510

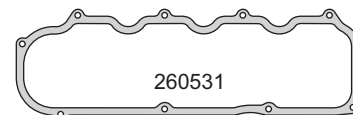

260531

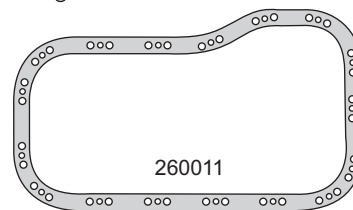

260011



260016

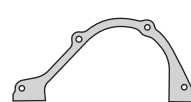

260012

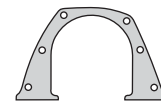

260013



260014

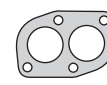

260018



260019



250425



260027



260528



260029



250429



260529



260530



260030



260033



260534



260035



260034

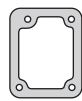

260535



260536



260041



260042



260038



260039



250144



R260011P



R250412P



R250413P

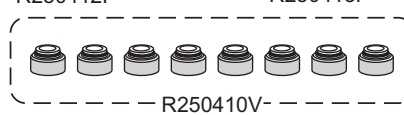

R250410V

FIAT / ALFA ROMEO

FIAT



Motor/Engine	Cm³	HP	Ø
160A	1995	126	84
154E	1995	140	84
836A	1995	145	84

Fiat: Tempra 1992/...
 Tipo i.e. 1989/93
 Cromo i.e 1993/...
 Coupe i.e - Turbo 1994



Nº OE	Descripción/Description	Mat.	Ref.
7076950	Jgo. de juntas para motor		260600-R
	Jgo. de juntas superior		260695
	Jta. tapa cilindros Ø 85 ± 1.70	NFT 1 1	260105
7709257	Jta. tapa cilindros Ø 85 ± 1.70	NFT	260107
	Jgo. tornillos tapa cilindros (HAR10168)		B260100
7527826	Jgo. juntas tapa válvulas (5)	N 1 1	260610
7646248	Jgo. junta para cárter	CG 1	260111
7589509	Tapa distribución	NB 1	260112
7679976	Bomba de agua	NB 1	250914
7700581	Múltiple escape	NFT 1 1	260616
7668195	Múltiple admisión con aislante bakelita	NB 1 1	260617
4176386	Salida de escape	FCH 1 1	250718
5949822	Termostato G 36 x 3	GS 1 1	250919
4161222	Tapa carga aceite	GS 1 1	260129
4129763	Porta retén bancada trasera	NB 1	250729
7748504	Inspección agua a block	SLS 1	260633
	Base termostato	NB 1 1	260634
7625793	Tubo respiradero	NB 1	260635
4337093	Filtro aceite	NB 1	250935
7700578	Cuerpo farfalliato	NB 1	260636
5969318	Aspirador bomba aceite	NB 1	260137
7703016	Tapa trasera árbol de levas	NB 2 2	260637
7639644	Tubo aspiración	NFT 1	260638
5873131	Tubo respiración	NB 1	260139
7701854	Termostato	NB 1	260639
7874731	Arandelas tapa de válvulas	GS 4 4	260642
	Kit de retenes completo		R260600
	Jgo. retén válvulas (16)	V 1	R260610V
	Retén bancada 74 x 90 x 10	P 1	R260111P
	Retén distribución 30 x 43 x 8	P 1	R260112P
	Retén árbol levas 30 x 42 x 7	P 2	R260113P
	Retén árbol levas 30 x 52 x 7	V	R260313V

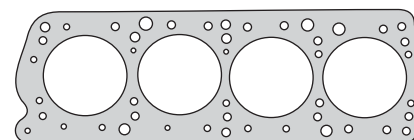

260105

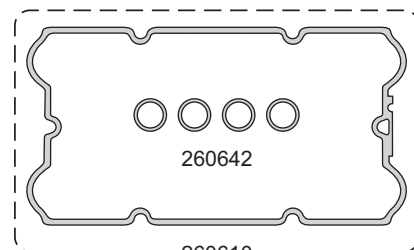

260642

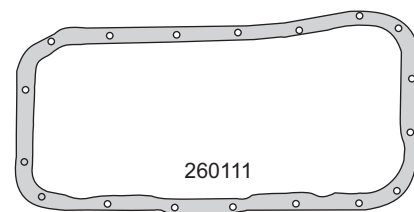

260610

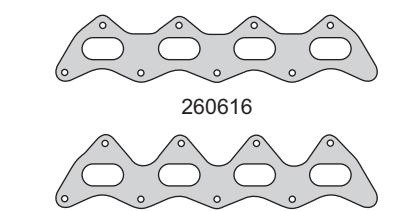

260111

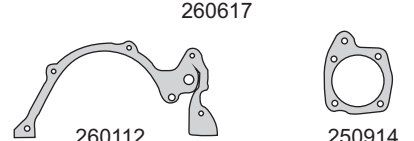

260616



260617



260112

250914

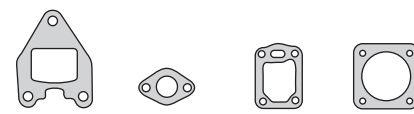

250718

250919

260129



250729

260633



260634

260635

250935

260636



260637

260638

260137

260139

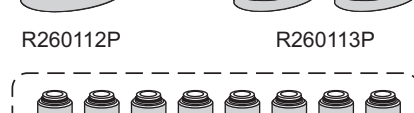

R260111P

R260112P

R260113P

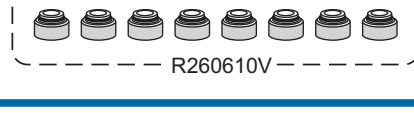

R260610V

FIAT / ALFA ROMEO

FIAT



Motor/Engine	Cm³	HP	Ø
146B	994	48/61	76

Fiat: Uno Mille - Palio - Siena 1983/...



Nº OE	Descripción/Description	Mat.	1	2	Ref.
	Jgo. de juntas para motor			●	260700-R
	Jgo. de juntas superior		●		260795
	Jta. tapa cilindros Ø 77 \pm 1.80		NFT	1	260705
	Jta. tapa cilindros Ø 77 \pm 1.90		NFT		260707
	Jgo. de tornillos para tapa de cilindros				B260500
4323710	Junta tapa válvulas		CG	1	260510
4249510	Jgo. junta para cárter		CG	1	260011
4249516	Tapa distribución		CB	1	260012
4249517	Porta retén trasero		NB	1	260013
4346415	Bomba de agua		NB	1	260014
4398359	Jgo. admisión y escape (2)		NFT	1	260016
	Salida de escape		FCH	1	260018
4250780	Tapa bomba de agua		CB	1	260019
4428157	Base carburador		NB	1	250425
4250500	Bomba de aceite		CB	1	260027
4081257	Base bomba nafta		NB		250128
4427495	Bomba nafta 0.25		NB	1	260528
4296113	Tapa delantera tapa cilindro		NB	1	260029
	Superior bomba agua		NB	1	250429
4427495	Bomba nafta 0.8		NB	1	260529
4427495	Bomba nafta 1.2		NB	1	260530
4249520	Tapa árbol levas		NB	1	260030
	Junta tapa válvulas		NB	1	260531
4386806	Tapa block		CB	1	260033
4477229	Tapa block		CB	1	260034
4346834	Tensor correa		NB	1	260534
4434100	Colector aspiración		NB	1	260035
4346833	Tapa block al volante		NB	1	260535
4139959	Entre bomba y tubo		NB		260037
4109133	Tapón orificio distribuidor		NB	1	260038
4351195	Base termostato		NB	1	260041
4325360	Tapa retén aceite		NB	1	260042
	Base bomba nafta 0.5		NB	1	250144
	Kit de retenes completo				R260000
	Jgo. retén válvulas (8)		V	1	R250410V
	Retén bancada 70 x 85 x 8		P	1	R260011P
	Retén distribución 40 x 56 x 7		P	1	R250412P
	Retén árbol levas 30 x 52 x 7		P	2	R250413P

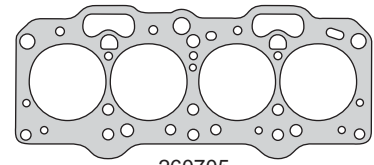

260705

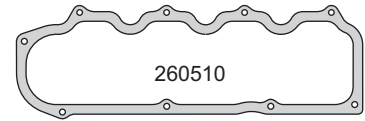

260510

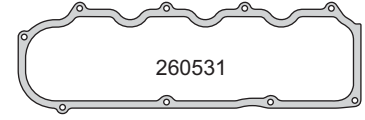

260531

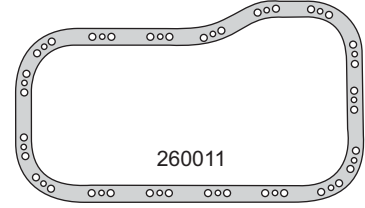

260011

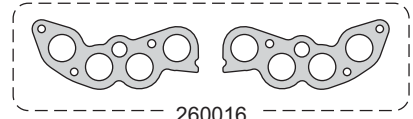

260016



260012



260013



260014



260018



260019

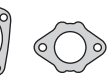

250425



260027



260528



260029



260529



250429



260530



260030

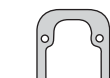

260033



260034



260534



260035



260535



260037



260038



260041

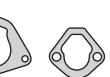

260042



250144



R260011P



R250412P



R250413P



R250410V

FIAT / ALFA ROMEO

FIAT



Motor/Engine	Cm³	HP	Ø
154C4.046	1995	153	84
159A6.046	1995	115	84
834B.146	1995	115	84

Zact 8V

Fiat: Tempra i.e - Tipo i.e - Cromia i.e
Cromia i.e Turbo 1992/95



Nº OE	Descripción/Description	Mat.	Ref.
7096175	Jgo. de juntas para motor		260800-R
	Jgo. de juntas superior		260895
	Jta. tapa cilindros Ø 85 ± 1.70	NFT 1 1	260105
7709257	Jta. tapa cilindros Ø 85 ± 1.70	NFT	260107
	Jgo. tornillos tapa cilindros (HAR10168)		B260100
7715789	Conj. junta tapa válvulas (6)	P 2 2	260810
	Junta para cárter	CG 1	260111
7589509	Tapa distribución	NB 1	260112
7679976	Bomba de agua	NB 1	250914
4177112	Múltiple escape	NFT 1 1	250716
7714537	Múltiple admisión	NFT 1 1	260117
4176386	Salida de escape	FCH 1 1	250718
5949822	Termostato	GS	250919
	Jgo. juntas carburador	VS	260121
	Base carburador	NB 2 2	260825
4161222	Tapa carga aceite	GS 1 1	260129
4129763	Porta retén bancada trasera	NB	1 250729
7547667	Inspección árbol levas	NFT 2 2	260130
50006916	Caballete T.V.	NFT 2 2	260131
4337093	Filtro aceite	NB	1 250935
5969318	Aspirador bomba aceite	NB	1 260137
7668658	Inspección agua a block	NB	1 260138
5873131	Tubo respiración	NB	1 260139
7541231	Tapa base termostato	NB 1 1	260140
5923392	Inferior base termostato	GS 1 1	260141
5972773	Cuerpo respiradero o'ring G 36 x 3	GS 2 2	260142
	Arandela tapa válvulas A 13 x 21 x 1,5 F	F 4 4	250742
	Junta apoyo distribuidor	NB	1 250443
4158100	Cuerpo inferior respiradero	NB	1 260143
10280060	Perilla tapa botadores	CU	260144
	Arandela A 14 x 20 x 2 C	CU 4 4	
	Kit de retenes completo		R260400
	Jgo. retén válvulas (8)	V 1	R250410V
	Retén bancada 74 x 90 x 10	P 1	R260111P
	Retén distribución 30 x 43 x 8	P 1	R260112P
	Retén árbol levas 30 x 52 x 7	P 2	R250413P

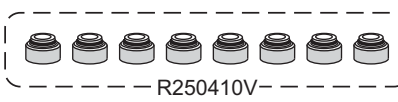
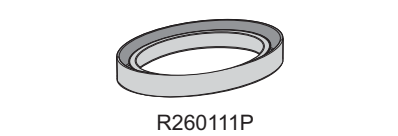
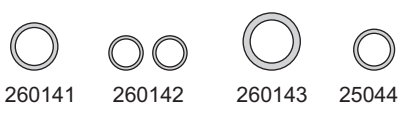
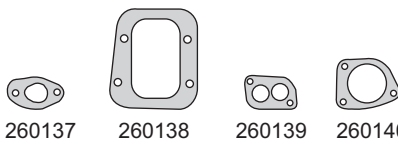
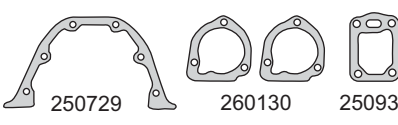
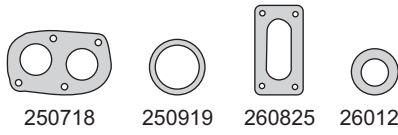
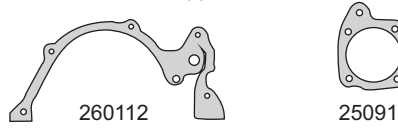
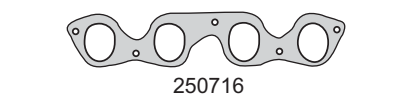
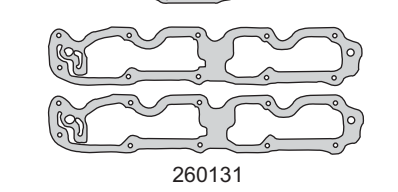
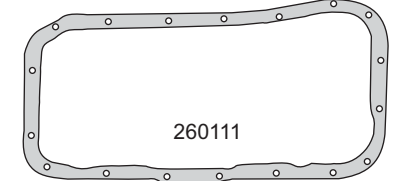
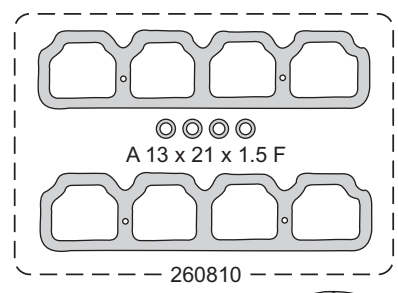
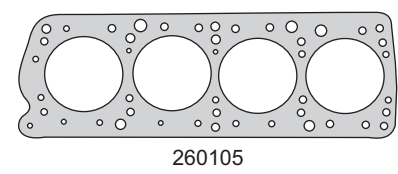

FIAT / ALFA ROMEO

FIAT



Motor/Engine	Cm³	HP	Ø
182A4/A6	1581	90/103	86.4
186A3/A4 Torque (16V)	1581	103	86.4

Fiat: Palio - Siena - Tipo 1.6 - Bravo - Marea
Multipla 1999/...

Lancia: Delta - Dedra - Lybra 1996/...



Nº OE	Descripción/Description	Mat.	1	2	Ref.
	Jgo. de juntas para motor				260900-R
	Jgo. de juntas superior		●	●	260995
	Jta. tapa cilindros Ø 87 ± 1.80	NFT	1	1	260905
464100960	Jta. tapa cilindros Ø 87 ± 1.80	NFT			260907
	Jgo. tornillos tapa cilindros (HAR12063)				B260900
7773831	Junta tapa válvulas (metálica)	SLS	2	2	260931
7663366	Junta para cárter	NB		1	260911
7737203	Porta retén delantero	NB		1	250412
46412116	Múltiple escape	NFT	1	1	260916
46410505	Múltiple admisión	NFT	1	1	260917
1482930	Salida de escape	FCH	1	1	250618
7770023	Pasaje de agua a tapa	NB	1	1	260919
	Tapa bomba aceite	CU		1	260927
4947376	Mariposa aire	NB	1	1	260929
7737204	Tapa inspección cigueñal	NB		1	250434
46413166	Salida de múltiple a catalizador	AC			260936
4179138	Base bomba aceite	NB		1	250439
4902267	Porta retén	NB		1	260241
46402220	Jgo. toberas multiple admisión (4)	N	1	1	260939
7792371	O'ring G 18.72 x 2.62	GS		1	
46428901	O'ring G 59.92 x 3.53	GS	2	2	
7792369	O'ring G 17.12 x 2.62	GS		1	
	O'ring G 55.25 x 2.62	GS	1	1	
	O'ring bomba de agua G 88.57 x 2.62	GS		1	
	O'ring bomba de agua G 31.34 x 3.53	GS		1	
	O'ring varilla aceite G 6.07 x 1.78	GS		1	
	O'ring llena aceite G 26.57 x 3.53	GS		1	
	O'ring árbol levas G 66.27 x 3.53	GS		1	
	O'ring tubo llenado G 50.39 x 3.53	GS		1	
	Kit de retenes completo				R260900
	Jgo. retén válvulas (16)	V		1	R260610V
	Porta retén bancada 64 x 81.50 x 8	V		1	PR260911V
	Retén distribución 40 x 56 x 7	P		1	R260312P
	Retén árbol levas bba. de aceite 30 x 42 x 7	P		1	R260113P
	Retén árbol levas 30 x 52 x 7	P		2	R260313P

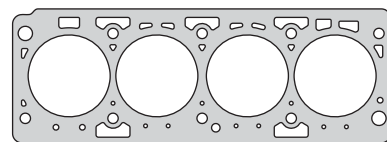

260905

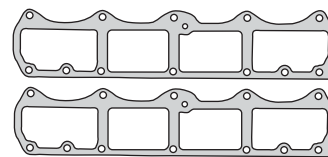

260931

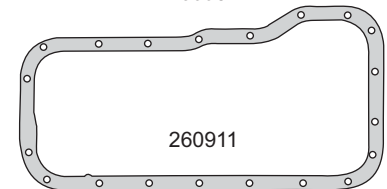

260911

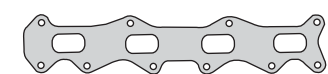

260916



260917



260939

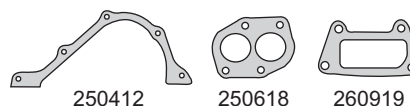

250412

250618

260919

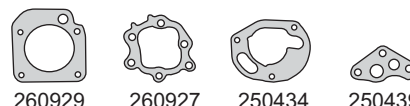

260929

260927

250434

250439

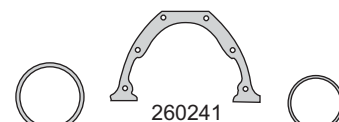

260241

G 66.27 x 3.53

G 55.25 x 2.62



G 59.92 x 3.53

G 88.57 x 2.62

G 50.39 x 3.53

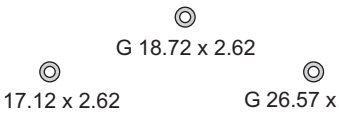

G 18.72 x 2.62

G 17.12 x 2.62

G 26.57 x 3.53



G 6.07 x 1.78

G 31.34 x 3.53

PR260911V



R260312P

R260313P

R260113P

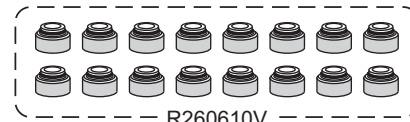

R260610V

FIAT / ALFA ROMEO

FIAT



Motor/Engine	Cm³	HP	Ø
182B6 - 178E7 Torque (16V)	1596	103	77

Fiat: Palio - Siena - Marea - Multipla 2001/...



Nº OE	Descripción/Description	Mat.	Ref.
	Jgo. de juntas para motor		261100-R MLS
	Jgo. de juntas superior	●	261195
	Jta. tapa cilindros Ø 81.5 \pm 0.35 N.R. (HAR12063)	MLS 1 1	261108
	Jgo. tornillos tapa cilindros (HAR12063)		B260900
7773831	Junta tapa válvulas (metálica)	SLS 2 2	260931
7663366	Junta para cárter	NB 1	260911
7737203	Porta retén delantero	NB 1	250412
46412116	Múltiple escape	NFT 1 1	260916
46410505	Múltiple admisión	NFT 1 1	260917
1482930	Salida de escape	FCH 1 1	250618
7770023	Pasaje de agua a tapa	NB 1 1	260919
	Tapa bomba aceite	CU 1	260927
4947376	Mariposa aire	NB 1 1	260929
7737204	Tapa inspección cigueñal	NB 1	250434
46413166	Salida de múltiple a catalizador	AC	260936
4179138	Base bomba aceite	NB 1	250439
4902267	Porta retén	NB 1	260241
46402220	Jgo. toberas múltiple admisión (4)	N 1 1	260939
7792371	O'ring G 18.72 x 2.62	GS 1	
46428901	O'ring G 59.92 x 3.53	GS 2 2	
7792369	O'ring G 17.12 x 2.62	GS 1	
	O'ring G 55.25 x 2.62	GS 1 1	
	O'ring bomba de agua G 88.57 x 2.62	GS 1	
	O'ring bomba de agua G 31.34 x 3.53	GS 1	
	O'ring varilla aceite G 6.07 x 1.78	GS 1	
	O'ring llena aceite G 26.57 x 3.53	GS 1	
	O'ring árbol levas G 66.27 x 3.53	GS 1	
	O'ring tubo llenado G 50.39 x 3.53	GS 1	
	Kit de retenes completo		R260900
	Jgo. retén válvulas (16)	V 1	R260610V
	Porta retén bancada 64 x 81.50 x 8	V 1	PR260911V
	Retén distribución 40 x 56 x 7	P 1	R260312P
	Retén árbol levas bba. de aceite 30 x 42 x 7	P 1	R260113P
	Retén árbol levas 30 x 52 x 7	P 2	R260313P

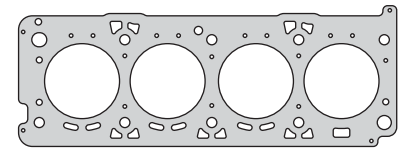

261108

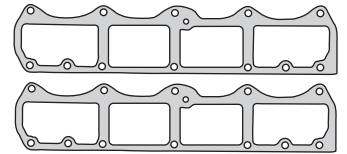

260931

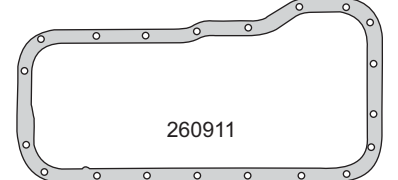

260911

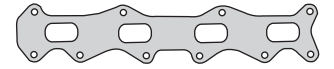

260916



260917



260939

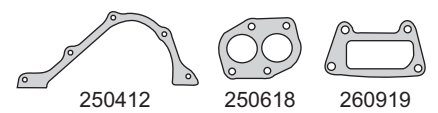

250412

250618

260919

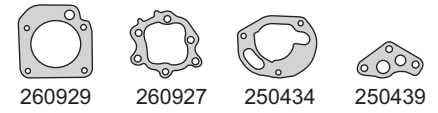

260929

260927

250434

250439

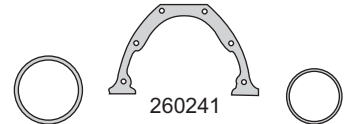

260241

G 66.27 x 3.53

G 55.25 x 2.62



G 59.92 x 3.53

G 88.57 x 2.62

G 50.39 x 3.53

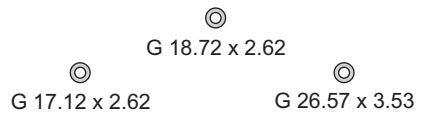

G 18.72 x 2.62

G 17.12 x 2.62

G 26.57 x 3.53



G 6.07 x 1.78

G 31.34 x 3.53

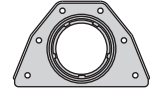

PR260911V



R260312P

R260313P

R260113P

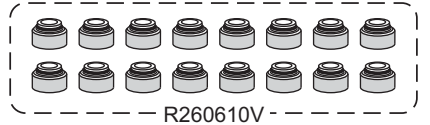

R260610V

FIAT / ALFA ROMEO

FIAT



Motor/Engine	Cm³	HP	Ø
149B - 176A	1697	58/69	82.6
160D - 280A1	1929	65/90	82.6
675.01 - 336.01	1929	90	82.6

Alfa Romeo: 146 TD 1994/99 - 155 TD 1993/97
Fiat: Fiorino - Uno - Tipo - Palio - Tempra
 Ducato - Siena TD
Lancia: Delta - Dedra TD 1994/99

DIESEL



Nº OE	Descripción/Description	Mat.	Ref.
	Jgo. de juntas para motor		260401-R
	Jgo. de juntas superior		270095-SM
	Jgo. de juntas superior		270095-1M
	Jgo. de juntas superior		270095-2M
	Jgo. de juntas superior		270095-3M
	Jgo. de juntas superior (MLS)		270095-SM MLS
	Jgo. de juntas superior (MLS)		270095-1M MLS
	Jgo. de juntas superior (MLS)		270095-2M MLS
	Jgo. de juntas superior (MLS)		270095-3M MLS
46431639	Junta tapa cilindros Ø 84 \pm 1.70	NFT 1	270007-SM
46431640	Junta tapa cilindros Ø 84 \pm 1.80	NFT	270007-1M
46431641	Junta tapa cilindros Ø 84 \pm 1.95	NFT	270007-2M
46431642	Junta tapa cilindros Ø 84 \pm 2.10	NFT	270007-3M
46451593	Jta. tapa cilindros Ø 83.5 \pm 1.65	MLS	270008-SM
46451594	Jta. tapa cilindros Ø 83.5 \pm 1.75	MLS	270008-1M
46451595	Jta. tapa cilindros Ø 83.5 \pm 1.85	MLS	270008-2M
46451596	Jta. tapa cilindros Ø 83.5 \pm 1.95	MLS	270008-3M
	Jgo. tornillos tapa cilindros (HAR12063)		B260400
7702774	Junta tapa válvulas	NB 1 1	260410
7647596	Junta para cárter	CG 1	260411
7625508	Tapa distribución	NB 1	260112
	Bomba de agua tapa PALIO/SIENA 1.9	NB	270014
7702770	Cuerpo bomba de agua	NB 1 1	260414
7765454	Múltiple admisión y escape turbo (NFT/CHA)	NFT 1	260415
7765454	Múltiple admisión y escape	NFT 1	260416
4364121	Bomba de agua a tapa cilindros	NB 1 1	260419
	Base filtro aceite	NB 1	260427
4129763	Porta retén bancada trasera	NB 1	250729
4161222	Tapa carga aceite	GS 1	260129
7702773	Tapa cámara agua	NB 1 1	260429
7702766	Soporte bomba inyectora	NB 1	260430
7702772	Termostato	NB 1 1	260431
	Tapa cámara agua	NB 1 1	260432
7702131	Tapa cámara block	NB 1	260433
7702769	Tapa soporte árbol levas	NB 1 1	260434
7696793	Tapa block lado distribución	CB 1	260435
7565461	Arandela parallamas	AC 4	560036
	Bomba de agua tapa DUCATO	NB 1	260436
5969318	Aspirador bomba aceite	NB 1	260137
7702768	Tapa árbol levas	NB 1 1	260437
7668658	Inspección agua block	NB 1	260138
	Salida agua	CB 1	260439
	Brida	NFT 2	260440
	Brida	NFT 1	260441
4158100	Anillo caño bomba agua G 36.09 x 3.53	GS 1 1	260442
	Bomba depresora	NB	260043
10282458	Cuerpo inferior respiradero	NB 1	260143
	O'ring bomba depresora G 40.94 x 2.62	GS	260044
	Arandela conducto combustible A 25 x 29 x 1C	CU 4	260444
	Jgo. caja velocidades DUCATO todos	VS	270050
	Junta caja velocidad	CB	270055
	Junta acople caja de velocidad	CB	270056
	Junta bolillero caja de velocidad	CB	270057

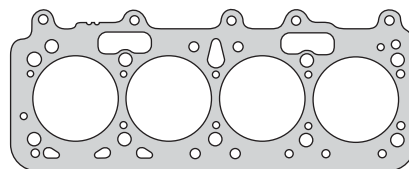

270007

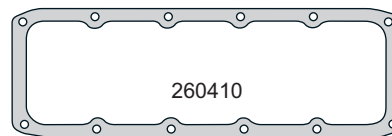

260410

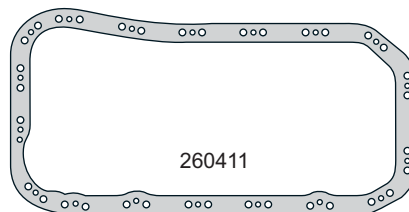

260411



260415



260112



260414

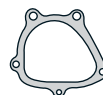

270014

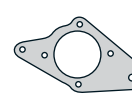

260419



260427



260429



250729



260129



260430



260431



260432



260433



260434



260435



260437



260436



560036



260137



260138



260439



260440



260441



260043



260143



A 25 x 29 x 1 C



G 40.94 x 2.62



G 36.09 x 3.53

FIAT / ALFA ROMEO

FIAT**taranto**

Motor/Engine	Cm ³	HP	Ø
149B - 176A	1697	58/69	82.6
160D - 280A1	1929	65/90	82.6
675.01 - 336.01	1929	90	82.6

Alfa Romeo: 146 TD 1994/99 - 155 TD 1993/97
Fiat: Fiorino - Uno - Tipo - Palio - Tempra
 Ducato - Siena TD
Lancia: Delta - Dedra TD 1994/99

DIESEL



R260111P







R260112P

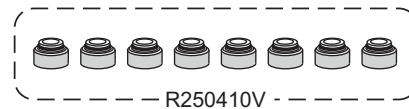

R250413P



R250410V

Nº OE	Descripción/Description	Mat.	Ref.
	O´ring G 69.52 x 2.62	GS	
	O´ring bomba depresora G 5.34 x 1.78	GS	
	Kit de retenes completo 		R260400
	Jgo. retén válvulas (8) 	V	1 R250410V
	Retén bancada 74 x 90 x 10 	P	1 R260111P
	Retén distribución 30 x 43 x 8 	P	1 R260112P
	Retén árbol levas 30 x 52 x 7 	P	2 R250413P

FIAT



Motor/Engine	Cm³	HP	Ø
8140.27/S	2499	103	93
8140.47/R/S	2499	110/116	93
8140.47.X230	2499	116	93

Fiat: Ducato TD 1990/94 - Ducato TDS 1994/96
Ducato TDSE 1996/...

Iveco: Daily Turbo 1990/...

DIESEL



Nº OE	Descripción/Description	Mat.	1	2	Ref.
	Jgo. de juntas para motor			●	270100-R
	Jgo. de juntas para motor				270101-R
	Jgo. de juntas superior				270195-SM
	Jgo. de juntas superior				270195-1M
	Jgo. de juntas superior		●		270195-2M
	Jgo. de juntas superior				270195-3M
99432354	Jta. tapa cilindros Ø 96 ≥ 1.30	NFT			270107-SM
99432353	Jta. tapa cilindros Ø 96 ≥ 1.40	NFT			270107-1M
99460983	Jta. tapa cilindros Ø 96 ≥ 1.50	NFT	1	1	270107-2M
99458402	Jta. tapa cilindros Ø 96 ≥ 1.60	NFT			270107-3M
	Jgo. tornillos tapa cilindros (HAS17038)				B270100
	Junta tapa válvulas	GS	1	1	270110
99488483	Junta para cárter	CG		1	270111
	Tapa distribución	NB		1	270112
	Tapa delantera cigüeñal	NB		1	270113
	Bomba de agua	NB		1	251114
98434020	Jgo. múltiple escape (4)	NFT	1	1	270116
98425767	Jgo. múltiple admisión (4)	NFT	1	1	270117
98421297	Salida de escape	NFT		1	270118
	Porta termostato	NB	1	1	270119
	Tapa trasera cigüeñal	NB		1	270129
	Junta tapa delantera block	NB		1	270130
	Bomba vacío	NB	1	1	270131
	Filtro aceite	NB		1	270132
	Filtro aceite	CB		1	270133
	Junta tapa trasera block	NB		1	270134
98430444	Comando bomba inyectora	NB		1	270135
	Junta base filtro aceite	NB		1	270136
	Brida agua	NB		4	270137
98432857	Intermedio block izquierdo	GS		1	270138
	Intermedio block derecho	GS		1	270139
	Brida	NB	1	1	270140
	Brida	NB	1	1	270141
	Brida	NB		1	270142
	Brida	NB		1	270143
	Brida	NB	2	2	270144
	Arandela A 38 x 46 x 4 C	CG		1	270145
	Junta porta retén árbol de levas	NFT			251146
36885008	Escape turbo	AC	1	1	350462
	O'ring G 44.12 x 2.62	GS		1	
	O'ring G 64.77 x 2.62	GS		1	
	O'ring G 98.02 x 3.53	GS			
	O'ring G 9.25 x 1.78	GS		3	
	O'ring G 18.77 x 1.78	GS		2	
	O'ring G 20.30 x 2.62	GS		15	
	O'ring G 23.47 x 2.62	GS		1	
	O'ring G 21.89 x 2.62	GS		1	
	O'ring G 21 x 1.5	GS		2	
	O'ring G 20 x 2	GS		2	
	O'ring G 17.12 x 2.62	GS		1	
	O'ring G 31.42 x 2.62	GS		2	
	O'ring G 56.87 x 1.78	GS		1	
	Arandela A 9 x 13 x 0.5 C	CU		5	

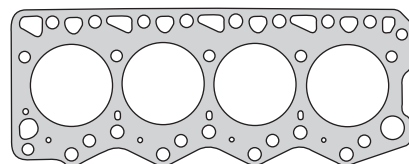

270107

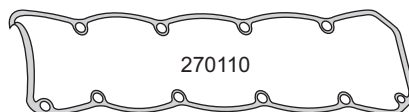

270110



270138



270139

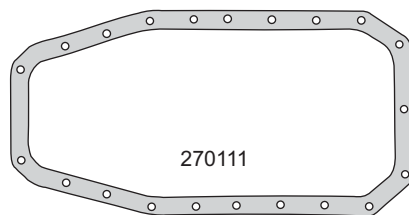

270111

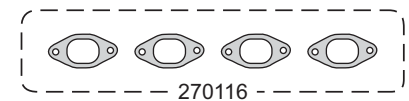

270116

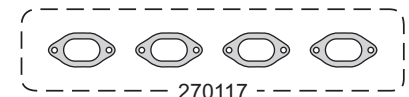

270117

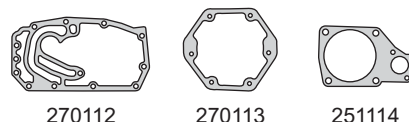

270112

270113

251114

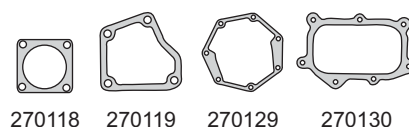

270118

270119

270129

270130



270131

270132

270133

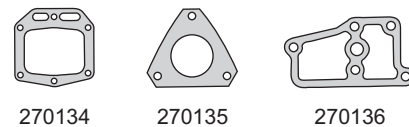

270134

270135

270136



270137



270140

251146

270144

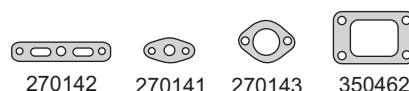

270142

270141

270143

350462

FIAT / ALFA ROMEO

FIAT



Motor/Engine	Cm³	HP	Ø
8140.27/S	2499	103	93
8140.47/R/S	2499	110/116	93
8140.47.X230	2499	116	93

Fiat: Ducato TD 1990/94 - Ducato TDS 1994/96
Ducato TDSE 1996/...

Iveco: Daily Turbo 1990/...

DIESEL



Nº OE	Descripción/Description	Mat.	Ref.
	Arandela A 10.3 x 14 x 1 C	CU	2
	Arandela A 10 x 14 x 1 A	AL	1
	Arandela A 14 x 18 x 1.5 C	CU	4
	Arandela A 12 x 18 x 1 C	CU	4
98429280	Arandela A 20 x 26 x 1.5 C	CU	3
	Arandela A 22 x 28 x 1.5 C	CU	4
	Arandela A 28 x 38 x 1.5 C	CU	1
	Kit de retenes completo		R270100
	Jgo. retén válvulas (8)	V	1 R270110V
40100311	Retén bancada 90 x 115 x 13	V	1 R270111V
99468744	Porta retén bancada 1996/...	V	PR270111-1V
	Porta retén distribución 1996/...	V	PR270112-1V
98454053	Retén distribución 70 x 90 x 10	V	1 R270112V
98454045	Retén árbol levas 50 x 70 x 10	V	1 R270113V
98454041	Retén auxiliar 55 x 70 x 10	V	1 R270115V

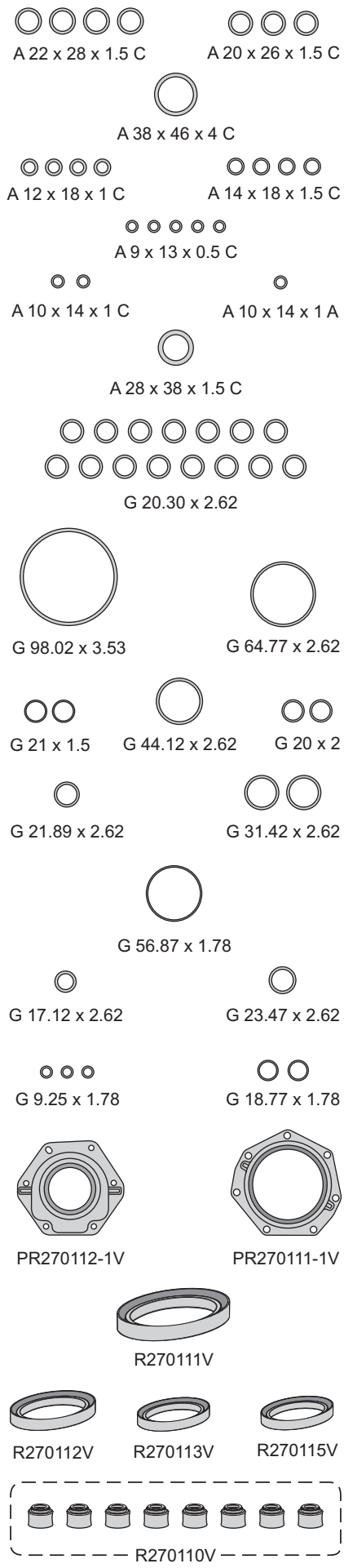

FIAT / ALFA ROMEO

FIAT



Motor/Engine	Cm³	HP	Ø
ED/EDX MPI EL MPI	994 1495	48/61 76	76 76

Fiat: Palio 1.0 ED/EDX MPI 96
Palio 1.5 EL MPI 96



Nº OE	Descripción/Description	Mat.	Ref.
	Jgo. de juntas para motor		270200-R
	Jgo. de juntas superior	●	270295
7702873	Jta. tapa cilindros Ø 77 \pm 1.80	NFT 1 1	260705
	Jta. tapa cilindros Ø 77 \pm 1.90	NFT	260707
	Jgo. de tornillos para tapa de cilindros		B260500
4249510	Jgo. junta para cárter	CG 1	270211
4249516	Tapa distribución	CB 1	260012
4249517	Porta retén trasero	NB 1	260013
46451539	Múltiple escape	NFT 1 1	270216
46435756	Multiple admisión	NB 1 1	270217
	Salida de escape	FCH 1 1	270218
4250780	Tapa bomba de agua	CB 1 1	260019
46436930	Termostato a block	NB 1 1	270219
4250500	Bomba de aceite	CB 1	260027
	Superior bomba de agua	NB 1 1	250429
4296113	Tapa delantera tapa cilindro	NB 1 1	260029
4249520	Tapa árbol levas	NB 1	260030
4323710	Junta tapa válvulas	NB 1 1	260531
4386806	Tapa block	CB 1	260033
46440387	Tapa trasera tapa cilindros	NB 1 1	270233
4477229	Tapa block	CB 1	260034
4346834	Tensor correa	NB 1	260534
4434100	Colector aspiración	NB 1	260035
46435757	Base inyección	NB 1 1	270235
4346833	Tapa block al volante	NB 1	260535
4139959	Entre bomba y tubo	NB	260037
7733577	Bomba de aceite	NB 1	270237
4325360	Tapa retén aceite	NB 1 1	260042
	Kit de retenes completo		R260000
	Jgo. retén válvulas (8)	V 1	R250410V
	Retén bancada 70 x 85 x 8	P 1	R260011P
	Retén distribución 40 x 56 x 7	P 1	R250412P
	Retén árbol levas 30 x 52 x 7	P 2	R250413P

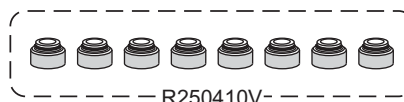
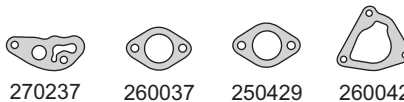
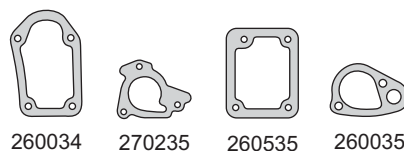
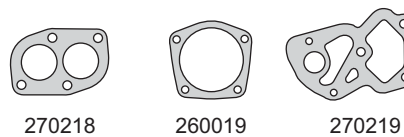
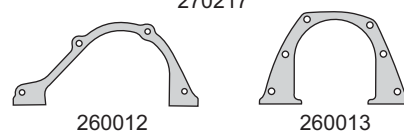
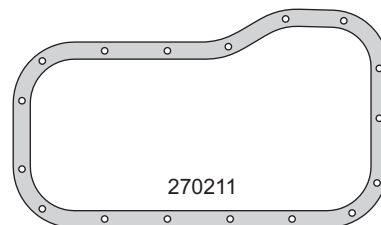
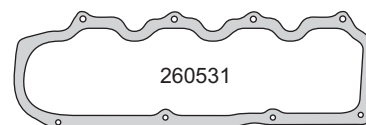
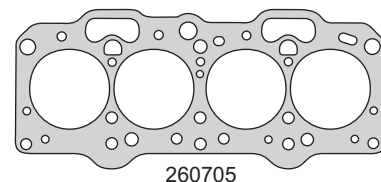

FIAT / ALFA ROMEO

FIAT



Motor/Engine	Cm³	HP	Ø
8140.43	2799	122	94.4
S9W 700/702	2799	115	94.4

Fiat: Ducato 14TDS - Ducato Maxi 18TDS
1996/...

Renault: Master TD 1998/...

DIESEL



Nº OE	Descripción/Description	Mat.	Ref.
	Jgo. de juntas para motor		270300-R
	Jgo. de juntas para motor		270301-R
	Jgo. de juntas superior		270395-SM
	Jgo. de juntas superior	●	270395-1M
	Jgo. de juntas superior		270395-2M
	Jgo. de juntas superior		270395-3M
99432354	Jta. tapa cilindros Ø 96 \pm 1.30 N.R.	NFT	270107-SM
99432353	Jta. tapa cilindros Ø 96 \pm 1.40 N.R.	NFT	1 270107-1M
99460983	Jta. tapa cilindros Ø 96 \pm 1.50 N.R.	NFT	1 270107-2M
99458402	Jta. tapa cilindros Ø 96 \pm 1.60 N.R.	NFT	270107-3M
	Jgo. tornillos tapa cilindros (HAS17038)		B270100
500388381	Junta tapa válvulas	N	1 1 270310
500327660	Junta para cárter aspirado	CG	1 270311
99488483	Junta para cárter	CG	1 270111
	Junta distribución	NB	1 270112
	Junta tapa anterior cigüeñal	NB	1 1 270113
	Bomba de agua	NB	1 251114
98434020	Jgo. múltiple escape (4)	NFT	1 1 270116
98425767	Jgo. múltiple admisión (4)	NFT	1 1 270117
	Salida de escape	NFT	1 270118
98421297	Junta porta termostato	NB	1 1 270119
	Junta tapa trasera cigüeñal	NB	1 270129
	Arandela A 37 x 47 x 4	CG	1 270330
	Junta filtro de aceite	CB	1 270133
	Junta	NB	1 270134
98430444	Junta comando bomba inyectora	NB	1 270135
	Junta	NB	1 270136
98430478	Junta brida agua	NB	1 1 270137
	Intermedio block izquierda 2.5	GS	1 270138
99432807	Intermedio block izquierda	GS	1 270338
	Intermedio block derecha 2.5	GS	1 270139
99432808	Intermedio block derecha	GS	1 270339
	Tapa inspección block trasero	NB	1 270340
98426170	Colector admisión	NB	1 1 270341
	Junta colector turbo	NFT	1 1 270342
98484659	Junta escape turbo	AC	1 1 270345
	Guarnición termostato	GS	1 460245
4834948	Entre múltiple turbo	AC	1 1 500546
	Junta porta retén árbol de levas	NB	251146
99436990	Junta colector escape	AC	1 1 270347
	O'ring G 94.84 x 3.53	GS	1
	O'ring G 64.77 x 2.62	GS	1
	O'ring G 59.92 x 3.53	GS	1
	O'ring G 55.25 x 2.62	GS	1
	O'ring G 56.87 x 1.78	GS	1
	O'ring G 48.9 x 2.62	GS	1
	O'ring G 47.22 x 3.53	GS	2
	O'ring G 47.22 x 3.53	S	1
	O'ring G 44.04 x 3.53	GS	1
	O'ring G 37.77 x 2.62	GS	1
	O'ring G 29.82 x 2.62	GS	1
	O'ring G 23.47 x 2.62	GS	1
	O'ring G 18.64 x 3.53	GS	1

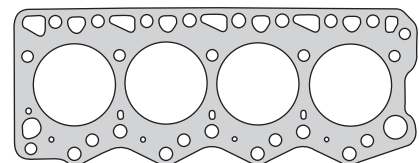

270107



270310



270138

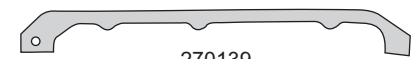

270139



270338



270339

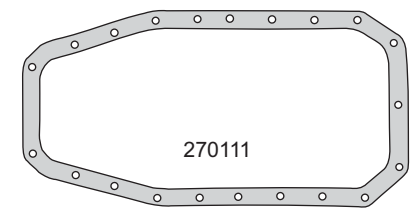

270111

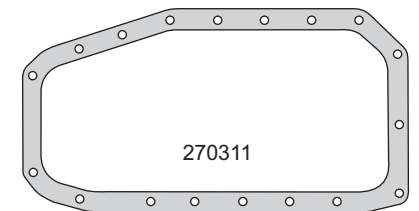

270311

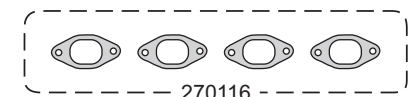

270116

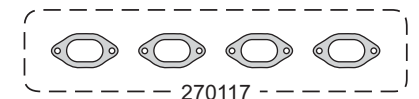

270117

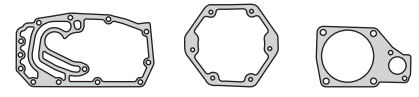

270112

270113

251114

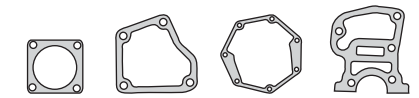

270118

270119

270129

270133

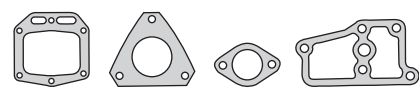

270134

270135

270137

270136



270340

270341

270342

460245

FIAT / ALFA ROMEO

FIAT



Motor/Engine	Cm³	HP	Ø
8140.43 S9W 700/702	2799 2799	122 115	94.4 94.4

Fiat: Ducato 14TDS - Ducato Maxi 18TDS
1996/...
Renault: Master TD 1998/...

DIESEL



Nº OE	Descripción/Description	Mat.	QTY	Ref.
	O'ring G 21.95 x 1.78	GS	2	
	O'ring G 18.72 x 2.62	GS	2	
	O'ring G 17.12 x 2.62	GS	2	
	O'ring G 17.17 x 1.78	GS	4	
	O'ring G 9.25 x 1.78	GS	3	
	Arandela tapón cárter A 22 x 27 x 1.5 C	CU	1	
	Arandela A 20 x 26 x 1 C	CU	1	
	Arandela A 20 x 26 x 0.5 C	CU	1	
	Arandela A 18 x 22 x 1.5 C	CU	1	
4858608	Arandela A 14 x 20 x 1.5 C	CU	4	4
	Arandela A 12 x 18 x 1.5 C	CU	4	4
4858606	Arandela A 10 x 14 x 1 C	CU	4	4
	Arandela A 8 x 14 x 0.5 C	CU	4	4
	Arandela A 7 x 13 x 1.5 A	AL	4	4
	Kit de retenes completo			R270100
	Jgo. retén válvulas (8)	V	1	R270110V
40100311	Retén bancada 90 x 115 x 13	V	1	R270111V
98454053	Retén distribución 70 x 90 x 10	V	1	R270112V
98454045	Retén árbol levas 50 x 70 x 10	V	1	R270113V
98454041	Retén auxiliar 55 x 70 x 10	V	1	R270115V

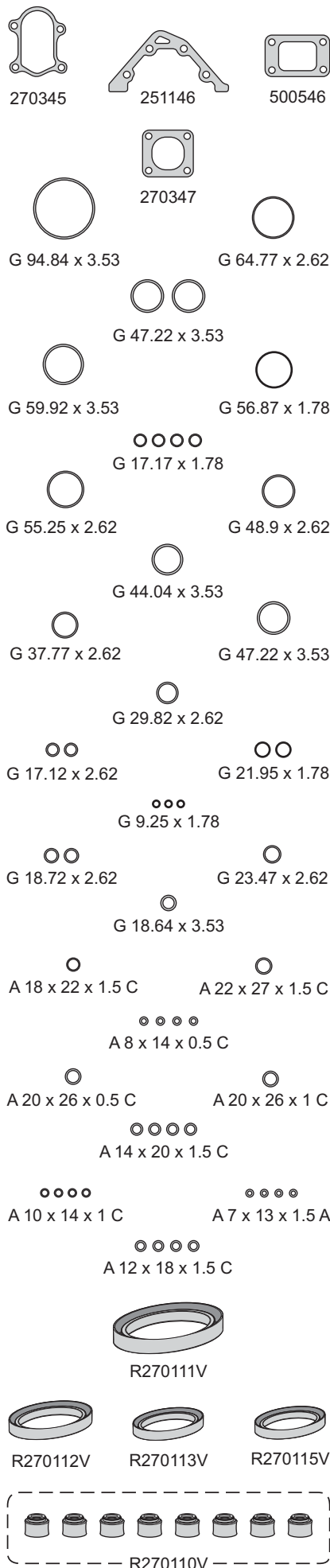

FIAT / ALFA ROMEO

FIAT



Motor/Engine	Cm³	HP	Ø
8140.67	2445	55	93
8140.67X230	2499	85	93
8140.67F37	2499	82	93
S8U	2499	55/75/80	93

Iny. Indirecta

Fiat: Nuovo Ducato 1989/94 - Ducato 1994/...
Iveco: Daily 30.8 - 35.8 1996/...
Renault: Master 1990/..., 1998/... - Trafic 1990/...
 Serie 742/748/770/772/758/780/782



DIESEL

Nº OE	Descripción/Description	Mat.	Ref.
	Jgo. de juntas para motor	●	270400-R
	Jgo. de juntas para motor		270401-R
98492581	Junta tapa cilindros Ø 95 ± 1.70	NFT	1 270407
4403137	Junta tapa cilindros Ø 95 ± 1.50	NFT	270407-1M
4403135	Junta tapa cilindros Ø 95 ± 1.60	NFT	270407-2M
	Jgo. tornillos tapa cilindros (HAS17038)		B270100
500388381	Junta tapa válvulas	N	1 270310
99488483	Junta para cárter	CG	1 270111
500327440	Junta para cárter	CG	1 270311
	Junta distribución	NB	1 270112
	Junta distribución	NB	1 270412
	Tapa delantera cigüeñal	NB	1 270113
	Bomba de agua	NB	1 251114
98434020	Jgo. múltiple escape (4)	NFT	1 270116
98425767	Jgo. múltiple admisión (4)	NFT	1 270117
	Salida de escape	NFT	1 270118
98421297	Porta termostato	NB	1 270119
	Tapa trasera cigüeñal	NB	1 270129
	Junta tapa delantera block	NB	1 270130
	Bomba vacio	NB	1 270131
	Filtro aceite	NB	1 270132
	Filtro aceite	CB	1 270133
	Junta tapa trasera block	NB	1 270134
98430444	Comando bomba inyectora	NB	1 270135
	Junta base filtro aceite	NB	1 270136
98430478	Brida agua	NB	1 270137
99432807	Intermedio block izquierdo	GS	1 270138
99432808	Intermedio block derecho	GS	1 270139
	Brida	NB	1 270140
	Brida	NB	1 270141
	Brida	NB	1 270142
	Brida	NB	1 270143
	Brida	NB	1 270144
	Arandela A 38 x 46 x 4 C	CG	1 270145
	Junta porta retén árbol de levas	NB	251146
	O'ring G 44.12 x 2.62	GS	1
	O'ring G 64.77 x 2.62	GS	1
	O'ring G 9.25 x 1.78	GS	3
	O'ring G 18.77 x 1.78	GS	2
	O'ring G 20.30 x 2.62	GS	15
	O'ring G 23.47 x 2.62	GS	1
	O'ring G 21.89 x 2.62	GS	1
	O'ring G 21 x 1.5	GS	2
	O'ring G 20 x 2	GS	2
	O'ring G 17.12 x 2.62	GS	1
	O'ring G 31.42 x 2.62	GS	2
	O'ring G 56.87 x 1.78	GS	2
	Arandela A 9 x 13 x 0.5 C	CU	5
	Arandela A 10.3 x 14 x 1 C	CU	2
	Arandela A 10 x 14 x 1 A	AL	1
	Arandela A 14 x 18 x 1.5 C	CU	4
	Arandela A 12 x 18 x 1 C	CU	4
98429280	Arandela A 20 x 26 x 1.5 C	CU	3

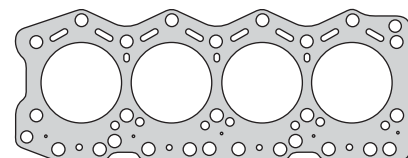

270407



270310



270138



270139

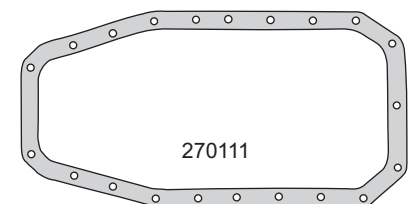

270111

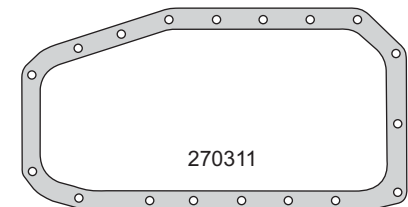

270311

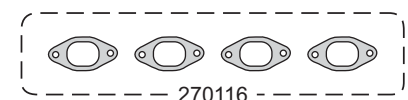

270116

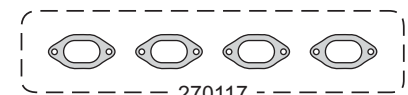

270117

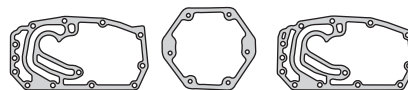

270112

270113

270412

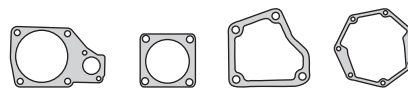

251114

270118

270119

270129

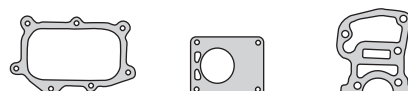

270130

270131

270132

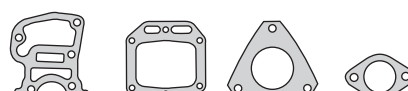

270133

270134

270135

270137



270136

270140

251146

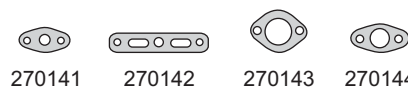

270141

270142

270143

270144

FIAT / ALFA ROMEO

FIAT



Motor/Engine	Cm³	HP	Ø
8140.67	2445	55	93
8140.67X230	2499	85	93
8140.67F37	2499	82	93
S8U	2499	55/75/80	93

Iny. Indirecta

DIESEL

Fiat: Nuovo Ducato 1989/94 - Ducato 1994/...
Iveco: Daily 30.8 - 35.8 1996/...
Renault: Master 1990/..., 1998/... - Trafic 1990/...
 Serie 742/748/770/772/758/780/782



Nº OE	Descripción/Description	Mat.	Ref.
	Arandela A 22 x 28 x 1.5 C	CU	4
	Arandela A 28 x 37 x 1.5 C	CU	1
	Kit de retenes completo		R270100
	Jgo. retén válvulas (8)	V	1 R270110V
40100311	Retén bancada 90 x 115 x 13	V	1 R270111V
99468744	Porta retén bancada 1996/...	V	PR270111-1V
	Porta retén distribución 1996/...	V	PR270112-1V
98454053	Retén distribución 70 x 90 x 10	V	1 R270112V
98454045	Retén árbol levas 50 x 70 x 10	V	1 R270113V
98454041	Retén auxiliar 55 x 70 x 10	V	1 R270115V

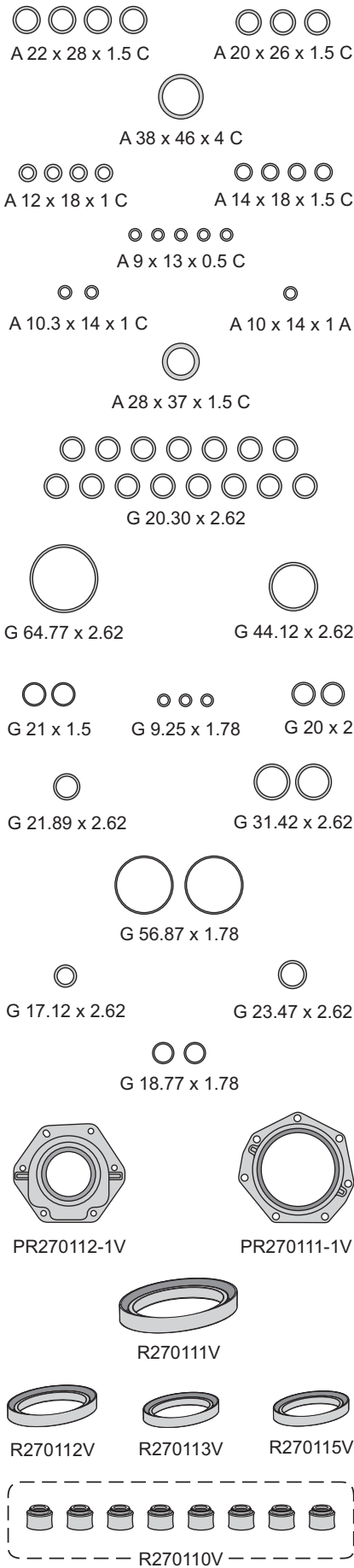

FIAT / ALFA ROMEO

FIAT



Motor/Engine	Cm³	HP	Ø
Fire 8V MPI	999	50	70
Fire 8V MPI	1300	75	70.8

Fiat: Uno - Palio - Siena - Mille Fire



Nº OE	Descripción/Description	Mat.	Ref.
	Jgo. de juntas para motor		270500-R
	Jgo. de juntas superior	●	270595
	Jgo. de juntas superior (MLS)		270595 MLS
	Jta. tapa cilindros Ø 71.5 ± 1.20 N.R.	NFT	1 1 270507
	Jta. tapa cilindros Ø 72 ± 1.95 N.R.	NFT	270507-1.9
46541379	Jta. tapa cilindros Ø 72 ± 0.35 N.R.	MLS	270508
	Jgo. tornillos tapa cilindros (HAS13038)		B270500
46748519	Junta tapa de válvulas	N	1 1 270510
4249510	Junta para cárter	GS	1 1 270511
46552427	Tapa distribución	NB	1 1 270512
46546134	Jgo. múltiple escape (2)	NFT	1 1 270515
71716583	Jgo. múltiple admisión (5)	GS	1 1 270517
	Salida de escape	FCH	1 1 270518
7604488	Termostato	NB	1 1 270519
46549928	Guarnición goma	GS	1 1 270532
46824135	Conducto pasaje agua-motor	GS	1 1 270533
14463580	O'ring G 30.8 x 3.7	GS	1 1
	O'ring G 21.95 x 1.78	GS	1
	Kit de retenes completo		R270500
7581344	Jgo. retén válvulas (8)	V	1 R270510V
7724665	Retén bancada 74 x 88 x 8 - hasta 2003	P	1 R270511P
55187497	Porta retén bancada - desde 2004/...	V	PR270511V
40004240	Retén árbol de levas 30 x 42 x 7	P	1 R260113P
	Retén bomba de aceite 27 x 37 x 7	P	1 R270515P

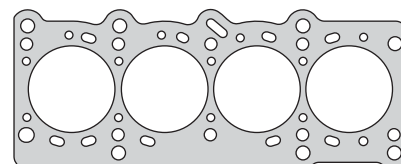

270507

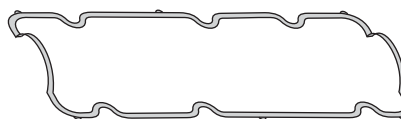

270510

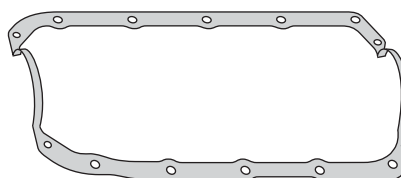

270511

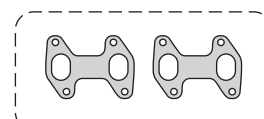

270515

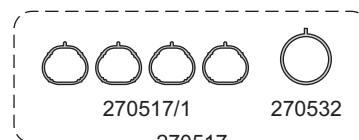

270517/1

270532

270517



270512

270518

270519



G 21.95 x 1.78

270533

G 30.8 x 3.7



PR270511V



R270511P



R260113P



R270515P



R270510V

FIAT / ALFA ROMEO

ALFA ROMEO



Motor/Engine	Cm³	HP	Ø
676.01	1598	120	82
671.06	1747	140/144	82
671.99	1747	140/144	82
322.01	1747	140/144	82

Alfa Romeo: 145/146/155/156 Twin Spark
1996/...



Nº OE	Descripción/Description	Mat.	Ref.
	Jgo. de juntas para motor		270600-R
	Jgo. de juntas superior	●	270695
60608895	Jta. tapa cilindros Ø 84 \pm 1.70	NFT 1 1	270607
	Jgo. tornillos tapa cilindros (HAR10168)		B270600
	Sellador líquido - caucho de silicona		TRN0280R
	Conjunto juntas tapa válvulas (2)	GS 1 1	270610
	Junta distribución	NB 1 1	270612
	Válvula mariposa aceleración	NB 1 1	270614
46526271	Múltiple escape	AC 1 1	270615
	Múltiple admisión	NFT 1 1	270617
	Tapa bomba aceite	AC 1	270627
	Entrada admisión	SLS 1 1	270632
	Salida admisión	SLS 1 1	270633
	Válvula bomba aceite	CB 1	270634
	Guarnición llenado aceite		270635
	Junta interior tapa de válvulas	GS 1 1	270642
	O'ring G 62,87 x 5,33	GS 1	
	Arandela A 12 x 18 x 1 C	CU 1	
	Arandela A 14 x 24 x 2 C	CU 1	
	Arandela A 19 x 26 x 1,5 C	CU 1	
	Kit de retenes completo		R270600
	Jgo. retén válvulas (16)	V 1	R260610V
60805182	Retén bancada 74 x 90 x 10	V 1	R260111V
90500805	Retén distribución 55 x 68 x 8	V 1	R270612V
60805219	Retén distribución 30 x 43 x 8	P 1	R260112P
60809849	Retén árbol levas 30 x 42 x 7	P 1	R260113P
	Retén árbol levas auxiliar 30 x 44 x 8	V 1	R270614V
7628850	Retén árbol levas auxiliar 31 x 41 x 7	V 1	R270615V

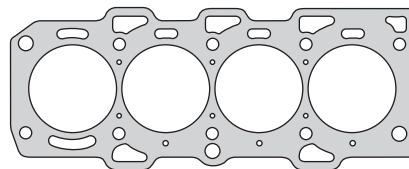

270607

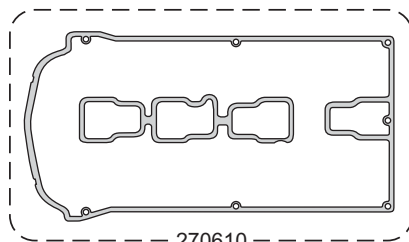

270610



270615

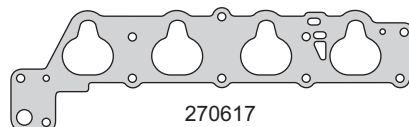

270617

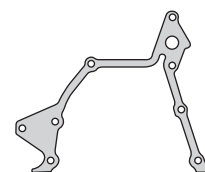

270612



270614



270627



270632



270633



A 14 x 24 x 2 C



270634



A 12 x 18 x 1 C



A 19 x 26 x 1.5 C



G 62.87 x 5.33



R260111V



R260112P



R270612V



R260113P



R270614V



R270615V

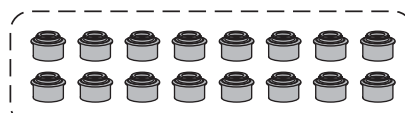

R260610V

FIAT / ALFA ROMEO

FIAT



Motor/Engine	Cm³	HP	Ø
Fire 1714130	999	70	71
Fire 188.A5 (DOHC) 16V	1242	80	71

Fiat: Palio - Siena - Palio Weekend - Palio Novo
Novo Siena - Doblo
Lancia: Ypsilon 2000/...



Nº OE	Descripción/Description	Mat.	Ref.
	Jgo. de juntas para motor		270700-R
	Jgo. de juntas superior	●	270795
	Jgo. de juntas superior		270795 MLS
	Junta tapa cilindros Ø 72 \pm 1.20	NFT 1 1	270707
46410960	Junta tapa cilindros Ø 72 \pm 0.35	MLS	270708
	Jgo. de tornillos para tapa de cilindros		B270700
46513955	Junta tapa de válvulas	SLS 1 1	270710
46745223	Junta para cárter aceite	CG 1	270711
46552317	Tapa distribución	NB 1	270712
46526271	Jgo. múltiple escape	NFT 1 1	270715
71716583	Jgo. múltiple admisión (5)	GS 1 1	270517
46774747	Salida de escape	FCH 1 1	270718
7604488	Termostato	NB 1 1	270519
	Junta estanqueidad	GS 1 1	270929
46751961	Tapa trasera distribución	SLS 1 1	270730
71716584	Guarnición admisión	GS 1 1	270731
46549928	Guarnición termostato	GS 1 1	270532
7689903	Guarnición goma	GS	270732
71716584	Carga de aceite	GS	270742
	O'ring G 21.95 x 1.78	GS	1
14463580	O'ring G 30.8 x 3.7	GS 1 1	
7083082	O'ring inyectores G 7.52 x 3.53	GS 5 5	
	Kit retenes completo		R270700
46470334	Jgo. retén válvulas (16)	V 1	R270710V
46751174	Porta retén bancada 74 x 187.5/141 x 17	V 1	PR270711V
46780736	Retén árbol de levas 40 x 55 x 7	P 2	R270713P
	Retén bomba de aceite 27 x 37 x 7	P 1	R270515P

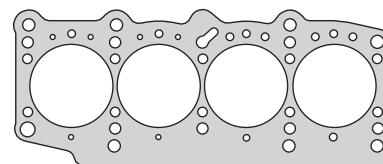

270707

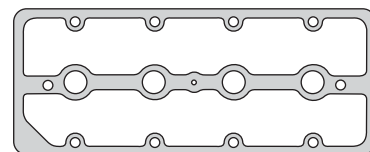

270710

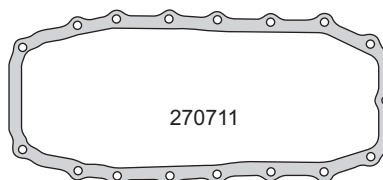

270711



270715

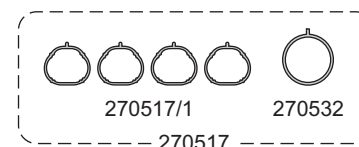

270517/1

270532

270517

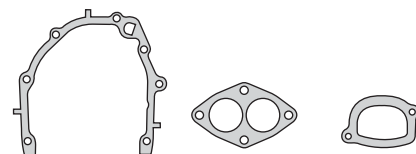

270712

270718

270519

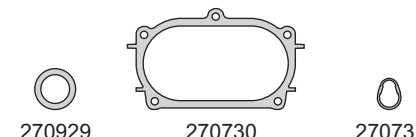

270929

270730

270731



G 7.52 x 3.53



G 30.8 x 3.7



G 21.95 x 1.78

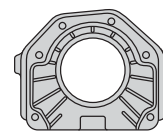

PR270711V



R270713P

R270515P

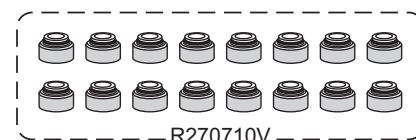

R270710V

FIAT / ALFA ROMEO

FIAT



Motor/Engine	Cm³	HP	Ø
182A1	1998	147	82
838A1/A6	1998	145/155	82
182B3/B7	1998	147/155	82

Fiat: Marea 1996/98 - 1999/...
Coupe 1996/01 - Bravo 1995/98
Lancia: Kappa - Libra 1996/00



Nº OE	Descripción/Description	Mat.	Ref.
	Jgo. de juntas para motor		270900-R
7766268	Junta tapa cilindros Ø 83 ± 1.80	NFT	1 270907
7710582	Jgo. tornillos tapa cilindros (HAR10168)		B270900
	Conj. juntas tapa válvulas (6)	GS	1 270910
	Junta para cárter	NB	1 270911
	Junta distribución	NB	1 270912
	Jgo. tapa distribución (4)	GS	270912-1
	Junta distribución	NB	1 270913
	Bomba de agua	NB	1 270614
46525557	Múltiple escape	AC	1 270915
7765227	Múltiple admisión	NFT	1 270917
	Junta estanqueidad	GS	1 270929
	Junta cierre estanqueidad	GS	1 270930
	Junta cierre estanqueidad	GS	270931
46464114	Junta cierre de alimentación	GS	1 270932
	Junta protección bujías	GS	5 270933
	Junta válvula bomba de aceite	CB	1 270634
	Junta	NB	1 271334
	Junta	NB	1 270938
	Bomba de agua	NB	1 270940
	Arandela A 18 x 22 x 1.5 C	CU	1
	O´ring G 17.17 x 1.78	GS	1
	O´ring G 53.64 x 2.62	GS	1
	O´ring G 79 x 1.8	GS	1
	O´ring G 34.65 x 1.78	GS	1
	O´ring G 21.89 x 2.62	GS	1
	O´ring G 7.52 x 3.53	GS	10
	Kit de retenes completo		R270900
	Jgo. retén válvulas (20)	V	1 R270910V
	Porta retén bancada	V	PR270911V
90500805	Retén distribución 55 x 68 x 8	V	1 R270612V
60809849	Retén árbol de levas 30 x 42 x 7	V	1 R260113V
7628850	Retén árbol de levas secundario 31 x 41 x 7	V	1 R270615V

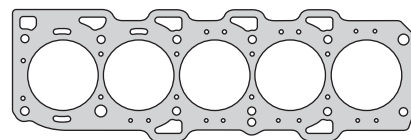

270907

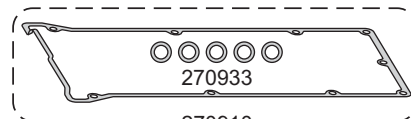

270933

270910

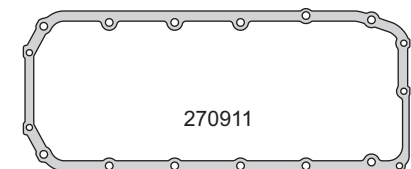

270911



270917



270915

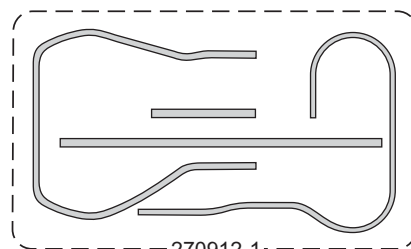

270912-1

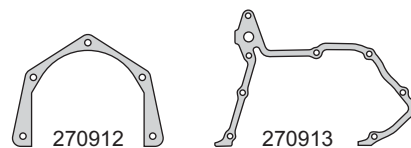

270912

270913

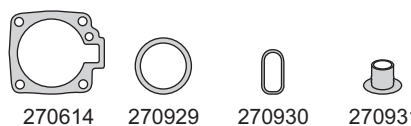

270614

270929

270930

270931

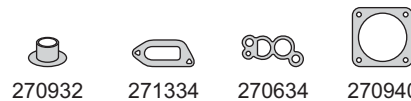

270932

271334

270634

270940



G 53.64 x 2.62

270938

G 79 x 1.8



G 17.17 x 1.78

G 21.89 x 2.62

G 34.65 x 1.78

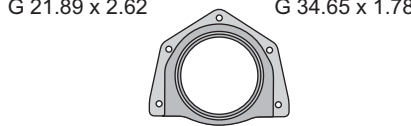

PR270911V



R270612V

R260113V

R270615V

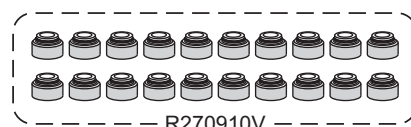

R270910V

FIAT / ALFA ROMEO

FIAT IVECO



Motor/Engine	Cm³	HP	Ø
8140.23	2799	99	94.4
8140.43	2799	122	94.4
Iny. Directa			

Iveco: Turbo Daily 35.10 - 49.12 1996/...
45.10 - 49.10 - 40.10
Turbo Daily 49.12 - 60.12 Intercooler

DIESEL



Nº OE	Descripción/Description	Mat.	Ref.
	Jgo. de juntas para motor		271101-R
99432354	Junta tapa cilindros Ø 96 \pm 1.30	NFT	270107-SM
99432353	Junta tapa cilindros Ø 96 \pm 1.40	NFT	270107-1M
99460983	Junta tapa cilindros Ø 96 \pm 1.50	NFT	270107-2M
99458402	Junta tapa cilindros Ø 96 \pm 1.60	NFT	270107-3M
48281505	Jgo. tornillos tapa cilindros (HAS17038)		B270100
500388381	Junta tapa válvulas	N	1 270310
994 88 483	Junta para cárter con limitadores de torque	CG	1 271111
	Frente distribución	NB	1 270112
	Tapa delantera cigüeñal	NB	1 270113
	Bomba de agua	NB	1 251114
98434020	Jgo. múltiple escape (4)	AC	1 271115
98425767	Jgo. múltiple admisión (4)	SLS	1 271117
	Salida de escape	NFT	1 270118
98421297	Porta termostato	NB	1 270119
	Bomba vacio	NB	1 270131
	Filtro aceite	NB	1 270132
98430444	Comando bomba inyectora	NB	1 270135
	Junta base filtro aceite	NB	1 270136
98430478	Brida agua	NB	1 270137
99432807	Intermedio block izquierdo esp. 2.5	GS	1 270338
	Anillo termostato	GS	1 330638
99432808	Intermedio block derecho esp. 2.5	GS	1 270339
	Tapa inspección block trasera	NB	1 270340
98426170	Colector admisión	NB	1 270341
98484659	Colector a turbo	AC	1 270345
	Entrada aceite a turbo	NB	1 271146
	Junta porta retén árbol de levas	NB	251146
99436990	Escape a turbo	AC	1 270347
	Salida aceite a turbo	NB	1 271147
	Brida cañería	NB	1 271148
	O'ring G 9.25 x 1.78	GS	4
	O'ring G 13.11 x 2.62	GS	1
	O'ring G 17.17 x 1.78	GS	6
	O'ring G 18.64 x 3.53	GS	1
	O'ring G 21.89 x 2.62	GS	1
	O'ring G 22.2 x 3.5	GS	2
	O'ring G 23.47 x 2.62	GS	1
	O'ring G 28.24 x 2.62	GS	1
	O'ring G 29.82 x 2.62	GS	1
	O'ring G 39.34 x 2.62	GS	1
	O'ring G 44.04 x 3.53	GS	1
	O'ring G 47.22 x 3.53	GS	3
	O'ring G 48.90 x 2.62	GS	2
	O'ring G 55.25 x 2.62	GS	1
	O'ring G 56.87 x 1.78	GS	1
	O'ring G 64.77 x 2.62	GS	1
	O'ring G 94.84 x 3.53	GS	1
	O'ring G 59.92 x 3.53	GS	1
	Arandela A 7 x 13 x 1.5 A	AL	1
	Arandela A 8 x 14 x 1 C	CU	5
4858606	Arandela A 10 x 14 x 1 C	CU	6
	Arandela A 12 x 16 x 1.5 C	CU	1

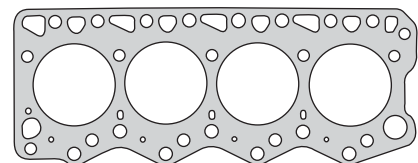

270107



270310

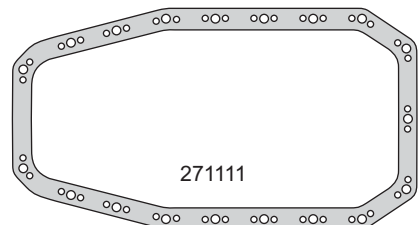

271111



270338

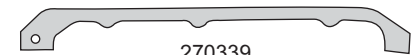

270339

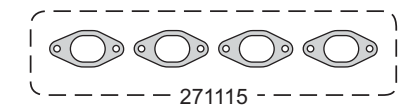

271115

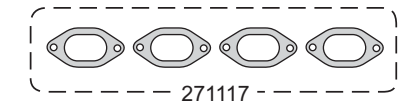

271117

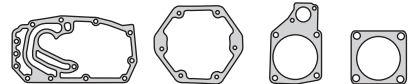

270112 270113 251114 270118

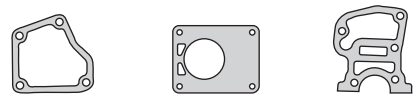

270119 270131 270132

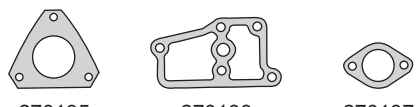

270135 270136 270137

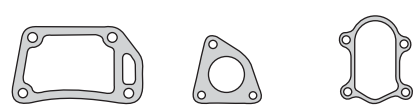

270340 270341 270345



270347 271147 251146



271146 G 59.92 x 3.53 271148



G 56.87 x 1.78 G 47.22 x 3.53



G 55.25 x 2.62 330638 G 64.77 x 2.62

FIAT / ALFA ROMEO

FIAT IVECO



Motor/Engine	Cm³	HP	Ø
8140.23	2799	99	94.4
8140.43	2799	122	94.4
Iny. Directa			

Iveco: Turbo Daily 35.10 - 49.12 1996/...
45.10 - 49.10 - 40.10
Turbo Daily 49.12 - 60.12 Intercooler



DIESEL

Nº OE	Descripción/Description	Mat.	Ref.
4858607	Arandela A 12 x 17 x 1.5 C	CU	5
	Arandela A 12 x 18 x 1.5 C	CU	1
4858608	Arandela A 14 x 20 x 1.5 C	CU	10
	Arandela A 16 x 20 x 1 C	CU	4
	Arandela A 18 x 22 x 1.5 C	CU	1
	Arandela A 20 x 26 x 1 C	CU	2
	Arandela A 22 x 27 x 1.5 C	CU	1
	Kit de retenes completo		R251100
98472291	Jgo. retén válvulas (8)	V	1 R270110V
99468744	Porta retén bancada 1996/...	V	PR270111-1V
	Porta retén distribución 1996/...	V	PR270112-1V
98454045	Retén árbol levas 50 x 70 x 10	V	1 R270113V
98454041	Retén auxiliar 55 x 70 x 10	V	1 R270115V

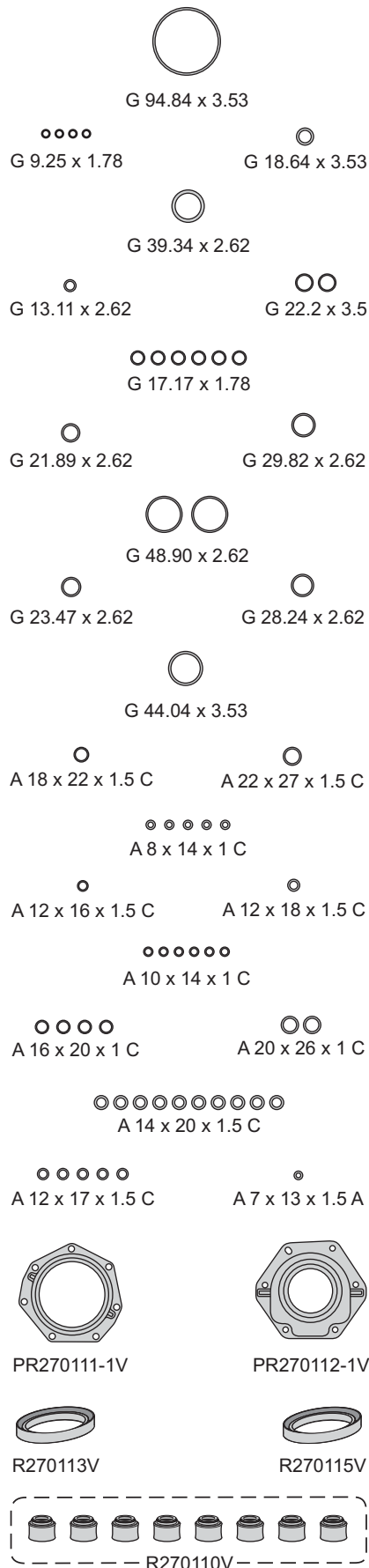

FIAT / ALFA ROMEO

FIAT



Motor/Engine Cm³ HP Ø

Fire 8V 1368 80/81 72

Fiat: Palio - Siena - Strada



Nº OE	Descripción/Description	Mat.	Ref.
	Jgo. de juntas para motor		● 271200-R MLS
	Jgo. de juntas superior (MLS)	●	271295 MLS
	Junta tapa cilindros Ø 72 \pm 1.20	NFT	271207
55190882	Junta tapa cilindros Ø 72 \pm 0.45	MLS	1 1 271208
	Jgo. tornillos tapa cilindros (HAS13038)		B270500
46748519	Junta tapa de válvulas	N	1 1 270510
46745223	Junta para cárter	CG	1 270711
7084019	Tapa distribución	NB	1 270712
55199355	Jgo. múltiple escape (2)	NFT	1 1 270515
71716583	Jgo. múltiple admisión (5)	GS	1 1 270517
	Salida de escape	FCH	1 1 270518
7604488	Termostato	NB	1 270519
14463580	O`ring bomba de agua a block G 29.74 x 3.53	GS	1 271219
46549928	Guarnición goma	GS	1 1 270532
46824135	Conexión sensor temperatura	GS	1 1 270533
14463580	O`ring G 30.8 x 3.7	GS	1 1
	Kit de retenes completo		R271200
	Jgo. retén válvulas (8)	V	1 R271210V
55187497	Porta retén bancada	V	PR270511V
40004240	Retén árbol de levas 30 x 42 x 7	P	1 R260113P
	Retén bomba de aceite 27 x 37 x 7	V	1 R270515V

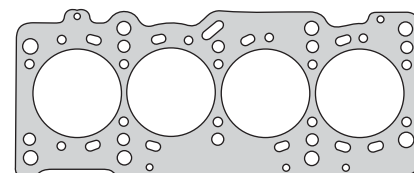

271208

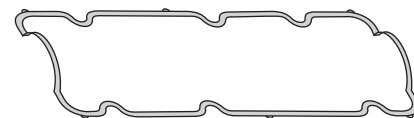

270510

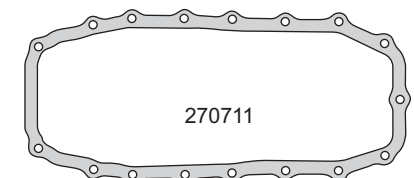

270711

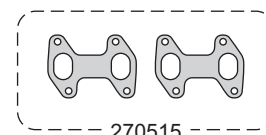

270515

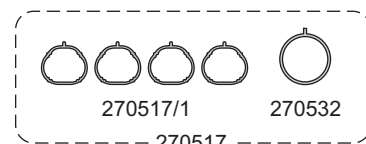

270517/1 270532

270517

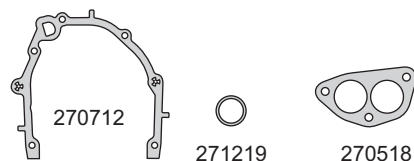

270712

271219

270518



270519

G 30.8 x 3.7

270533



PR270511V



R260113P

R270515V

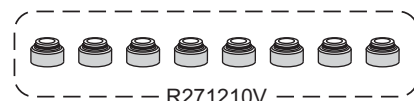

R271210V

FIAT / ALFA ROMEO

FIAT



Motor/Engine	Cm³	HP	Ø
182B7	1998	155	82
182B3	1998	155	82
838A1	1998	145	82

Fiat: Bravo - Coupe - Marea 1998/01
Lancia: Kappa 1994/01



Nº OE	Descripción/Description	Mat.	Ref.
	Jgo. de juntas para motor		271300-R
71713675	Jgo. de juntas superior	●	271395
7766268	Junta tapa cilindros Ø 83 ± 1.80 N.R. (HAR10168)	NFT 1 1	270907
7710582	Jgo. tornillos tapa cilindros (HAR10168)		B270900
46464114	Junta tapa válvulas	GS 1 1	271310
	Junta para cárter	NB 1	270911
46544944/1	Jgo. tapa distribución (2)	GS	271312
7774203	Junta frente motor, bomba de aceite	NB 1	270913
7772358	Múltiple escape	AC 1 1	271315
7765227	Múltiple admisión	SLS 1 1	271317
73503584	Salida de escape y acople catalizador	AC 1 1	271318
46464149	Guarnición cierre llenado aceite	GS 1 1	270929
55196309	Arandela tapón de cárter B 18 x 24 x 2.3 CN	CN	450029
	Junta cierre estanqueidad nivel aceite	GS	270931
	Entrada admisión	SLS	1 270632
	Guarnición goma G 69.5 x 74.5 x 6.5	GS	1 271333
	Junta entre colector y escape	SLS	271334
	Bomba de agua	NB 1	270940
7734963	Arandela bulón tapa de cilindro A 10 x 22.8 x 4 C	CU	
	Arandela A 18 x 26 x 1.5 C	CU	1
5894834	O´ring bomba de agua G 79 x 1.78	GS	1
	O´ring G 53.64 x 2.62	GS	1
	O´ring G 34.65 x 1.78	GS	1
	O´ring G 21.89 x 2.62	GS 1 1	
14457681	O´ring G 18.77 x 1.78	GS	1
	Kit de retenes completo		R270900
55188053	Jgo. retén válvulas (20)	V 1	R270910V
71718365	Porta retén bancada trasera	V	PR252011V
60603436	Retén árbol de levas 55 x 68 x 8	V 1	R270612V
40004240	Retén árbol de levas 30 x 42 x 7	V 1	R260113V
7628850	Retén árbol de levas secund. 31 x 41 x 7	V 1	R270615V

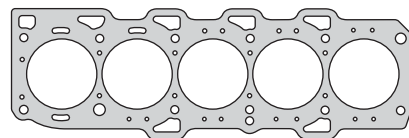

270907

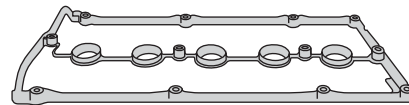

271310

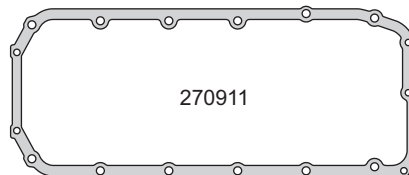

270911

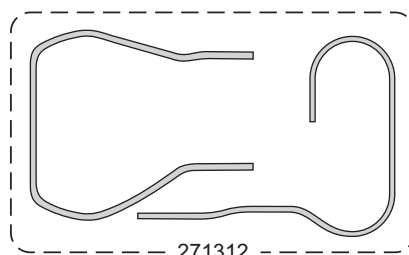

271312



271315



271317



270913

271318

270929



270931

270632

271334

270940

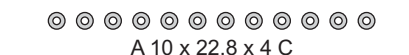

A 10 x 22.8 x 4 C



G 34.65 x 1.78

G 18.77 x 1.78



G 53.64 x 2.62



A 18 x 26 x 1.5 C

G 21.89 x 3.62



G 69.5 x 74.5 x 6.5

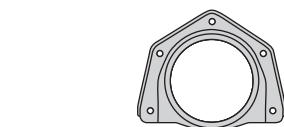

PR252011V



R270612V

R260113V

R270615V

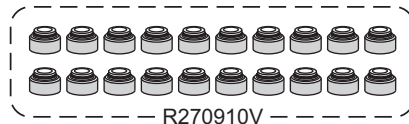

R270910V

FIAT / ALFA ROMEO

FIAT



Motor/Engine	Cm³	HP	Ø
188A9 (DOHC) 16V	1248	70	69.6

Fiat: Punto ELX JTD 2003/...
Strada Trekking Fase III JTD 2010/...

DIESEL



Nº OE	Descripción/Description	Mat.	Ref.
0071744288	Jgo. de juntas para motor	●	271500-R MLS
0055209070	Junta tapa cilindros Ø 70.5 \pm 0.70	MLS	1 271508-SM
0055209071	Junta tapa cilindros Ø 70.5 \pm 0.80	MLS	271508-1M
0055209072	Junta tapa cilindros Ø 70.5 \pm 0.90	MLS	271508-2M
	Jgo. de tornillos para tapa de cilindros		B271500
0073500063	Junta tapa válvulas/caballate	SLS	1 271510
	Junta para cárter	NH	271511
0055186663	Junta distribución	AL/GS	1 271512
0055209071	Guarnición bomba de agua G 66.5 x 70.5 x 3	GS	271514
0073500058	Múltiple escape	AC	1 271515
	Múltiple admisión	GS	1 271517
	Salida de escape a turbo	AC	1 271518
	Base termostato	GS	271519
0073501332	Junta base radiador aceite	GS	1 271527
	Junta acople tubo	SLS	1 271534
0055187301	Buje varilla de aceite	GS	271535
0071732845	Junta inspección placa	GS	1 271536
	Junta	SLS	1 271538
	Junta base turbo	AC	271539
	Junta distanciadora block	NB	1 271540
	Junta acople turbo	NB	271542
	Junta acople turbo rígido	SLS	271543
	Junta	NB	271544
	Junta acople turbo	NB	271545
0071740366	Junta trompa bomba de aceite	GS	271546
	Junta	SLS	271547
0073502578	Junta acople electro válvula	SLS	271548
	Junta	NB	1 271549
	Arandela tapón cárter A 10.4 x 15.8 x 1 A	AL	1
	Arandela pico inyector A 10 x 17 x 1 C	CU	
0014453781	O´ring G 21 x 1.5	GS	1
	O´ring G 15.7 x 3.1	S	1
	O´ring G 45 x 3	N	1
	O´ring G 45 x 50 x 4	S	1
	Kit de retenes completo		R271500
	Jgo. retén válvulas (16)	V	1 R271510V
	Retén bancada 78 x 100 x 9	T	1 R271511T
	Retén distribución 40 x 52 x 7	V	1 R420613V

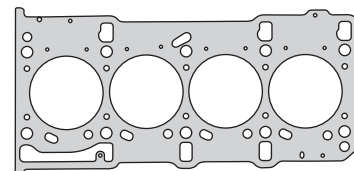

271508

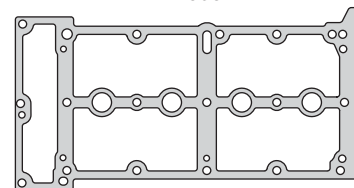

271510

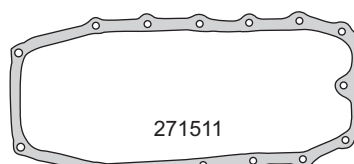

271511

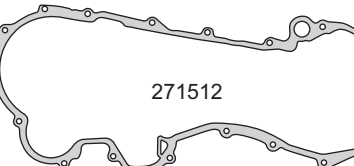

271512

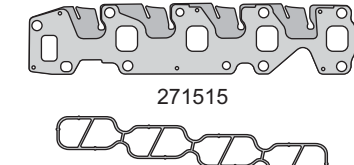

271515

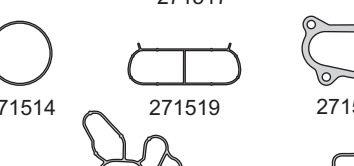

271517

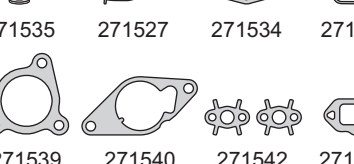

271514

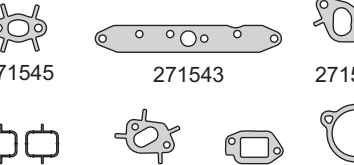

271519

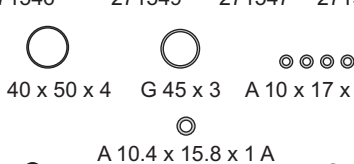

271518

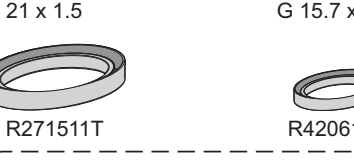

271535

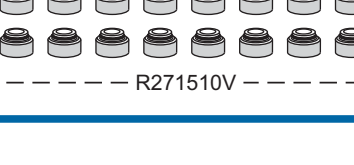

271527



271534

271536

271539

271540

271542

271538

271545

271543

271544

271546

271549

271547

271548

G 40 x 50 x 4

G 45 x 3

A 10 x 17 x 1 C

G 21 x 1.5

A 10.4 x 15.8 x 1 A

G 15.7 x 3.1

R271511T

R420613V

R271510V

FIAT / ALFA ROMEO

ALFA ROMEO



Motor/Engine	Cm³	HP	Ø
321.02 - 676.01	1598	120	82
322.01 (DOHC) 16V	1747	144	82

Alfa Romeo: 145/146 Twin Spark 1996/...
156 Twin Spark 1997/...
GTV Twin Spark 1998/00
Spider Twin Spark 1998/00



Nº OE	Descripción/Description	Mat.	Ref.
	Jgo. de juntas para motor		271800-R
	Jgo. de juntas superior	●	271895
60608895	Jta. tapa cilindros Ø 84 \pm 1.70	NFT 1 1	270607
	Jgo. tornillos tapa cilindros (HAR10168)		B270600
	Sellador líquido - caucho de silicona		TRN0280R
	Juntas tapa válvulas	GS 1 1	271810
	Junta distribución	NB 1 1	270612
	Válvula mariposa aceleración	NB 1 1	270614
46526271	Múltiple escape	AC 1 1	270615
	Múltiple admisión	NFT 1 1	270617
	Tapa bomba aceite	AC 1	270627
	Entrada admisión	SLS 1 1	270632
	Salida admisión	SLS 1 1	270633
	Válvula bomba aceite	CB 1	270634
	Guarnición llenado aceite		270635
	Junta interior tapa de válvulas	GS 1 1	270642
	O'ring G 62,87 x 5,33	GS 1	
	Arandela A 12 x 18 x 1 C	CU 1	
	Arandela A 14 x 24 x 2 C	CU 1	
	Arandela A 19 x 26 x 1,5 C	CU 1	
	Kit de retenes completo		R270600
	Jgo. retén válvulas (16)	V 1	R260610V
60805182	Retén bancada 74 x 90 x 10	V 1	R260111V
	Porta retén bancada	V	PR270911V
90500805	Retén distribución 55 x 68 x 8	V 1	R270612V
60805219	Retén distribución 30 x 43 x 8	P 1	R260112P
60809849	Retén árbol levas 30 x 42 x 7	P 1	R260113P
	Retén árbol levas auxiliar 30 x 44 x 8	V 1	R270614V
7628850	Retén árbol levas auxiliar 31 x 41 x 7	V 1	R270615V

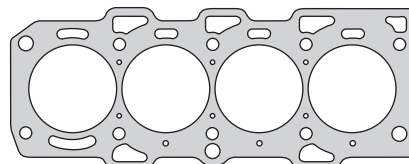

270607

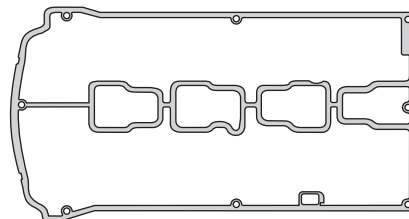

271810



270615

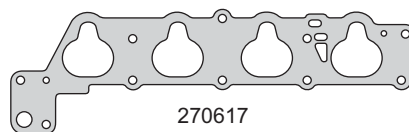

270617

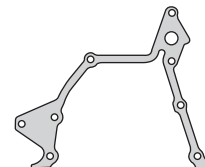

270612



270614



270627



270632



270633



A 14 x 24 x 2 C



270634



A 12 x 18 x 1 C



A 19 x 26 x 1.5 C



G 62.87 x 5.33

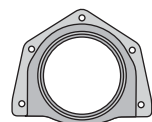

PR270911V



R260111V



R260112P



R270612V



R260113P



R270614V



R270615V

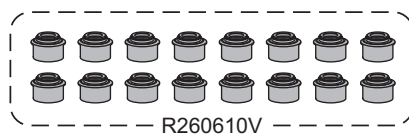

R260610V

FIAT / ALFA ROMEO

FIAT



Motor/Engine	Cm³	HP	Ø
350 A1	1242	70	72
169 A4	1368	77/80/82	72
Fire Evo			

Fiat: Fire 1.3 - Fiorino - 500 2007/...
 Fire 1.4 ELX - Evo 2010/... - Idea 2003/...
 Palio Fase II/III 2007/13 - Siena Gen. III
 MPI 2002/... - Grande Punto 2005/...
 Linea 2007/... - Strada Fase III

Lancia: Musa 2004/...



Nº OE	Descripción/Description	Mat.	Ref.
7087532	Jgo. de juntas para motor		271900-R MLS
	Jgo. de juntas superior (MLS)		271995 MLS
55190882	Jta. tapa cilindros Ø 72 \pm 0.45	MLS 1 1	271208
7696197	Jgo. tornillos tapa cilindros (HAS13038)		B270500
55222898	Junta tapa válvulas	GS 1 1	271910
46745223/1	Junta para cárter	CG 1	270711
7084019	Tapa distribución	NB 1	270712
	Bomba de agua	NH	251014
55194291	Jgo. múltiple escape (2)	AC 1 1	271915
71716583	Jgo. múltiple admisión (5)	GS 1 1	270517
7604488	Base termostato	NB 1 1	270519
14463580	O´ring bomba de agua a block G 29.74 x 3.53	GS 1	271219
46549928	Guarnición goma	GS 1 1	270532
46824135	Conexión sensor temperatura	GS 1 1	270533
7082509	O´ring de válvula G 28.17 x 3.53	GS	1
	O´ring de válvula G 7.52 x 3.53	GS	1
	O´ring G 30.8 x 3.7	GS 1 1	
	Kit de retenes completo		R271900
55190344	Jgo. retén válvulas (8)	V 1	R271210V
5210858	Porta retén bancada trasera	VF	PR271911VF
55206525	Retén árbol de levas 40 x 55 x 7	V 1	R270713V
46404094	Retén bomba de aceite 27 x 37 x 7	V 1	R270515V

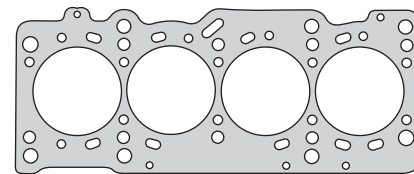

271208

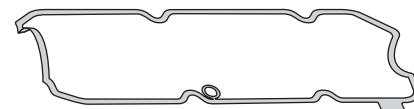

271910

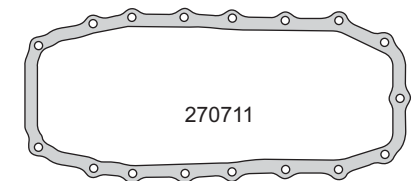

270711

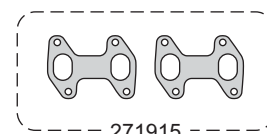

271915

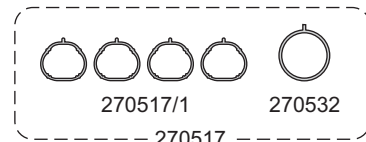

270517/1

270532

270517

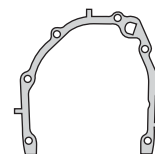

270712



251014



270519



271219



G 28.17 x 3.53



270533



G 7.52 x 3.53



G 30.8 x 3.7

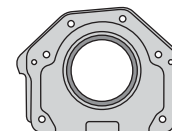

PR271911VF



R270713V



R270515V



R271210V

FIAT / ALFA ROMEO

FIAT



Motor/Engine	Cm³	HP	Ø
178D20.11 178D22.11 E.torQ 16V (SOHC)	1598	115	77

Fiat: Idea Essence - Idea Sporting
Idea Adventure - Siena Fase III Essence
Strada Fase III Adventure
Palio Wend Fase III/IV Adventure
Adventure 2010/...
Punto Essence 2011/...



N° OE	Descripción/Description	Mat.	Ref.
7087743	Jgo. de juntas para motor		272000-R MLS
	Jgo. de juntas superior (MLS)		272095 MLS
55226527	Jta. tapa cilindros Ø 78 ± 0.60	MLS 1 1	272008
55223509	Jgo. de tornillos para tapa de cilindros		B272000
55224544	Conj. junta tapa de válvulas (17)	GS 1 1	272010
55226126	Guarnición entre cárter y basamiento	NFT 1 1	272011
55224457	Múltiple escape	AC 1 1	272015
7087745	Jgo. múltiple admisión (5)	S 1 1	272017
55227126	Guarnición frente motor bomba aceite	P	272027
	Arandela junta tapa válvulas	GS 12 12	272030
55224542	Retén capuchón bujías	P 4 4	R272030P
7087746	Guarnición cuerpo mariposa	P 1 1	272032
46824135	Guarnición sensor temperatura	GS 1 1	270533
7087876	Guarnición entrada aceite a bba G 27 x 32.5 x 4.5	P 1	272034
7087877	Guarnición salida aceite a bba G 22.5 x 27.5 x 5.5	P 1	272035
55231652	Guarnición base filtro aceite	GS	272037
55229989	O´ring G 12.37 x 2.62	GS	
55229787	O´ring G 20.30 x 2.62	GS	
	O´ring inyector G 10 x 2	GS	4
	Kit de retenes completo		R272000
55223481	Jgo. retén válvulas (16)	P 1	R272010P
55223567	Retén bancada trasera 91 x 111 x 10	V 1	R330511V
	Retén distribución 32 x 45 x 6.5	P 1	R230412P
55224542	Retén árbol de levas 40 x 55 x 7	V 1	R270713V

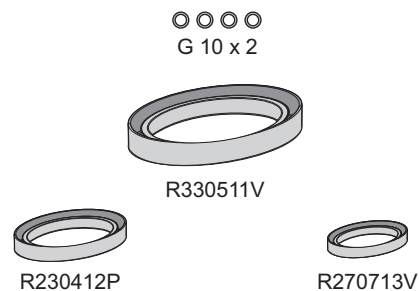
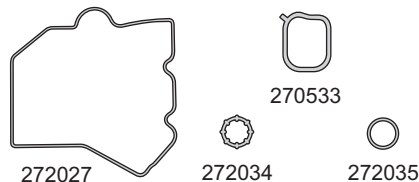
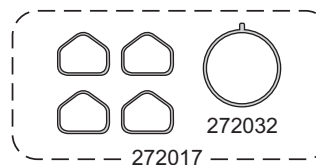
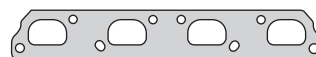
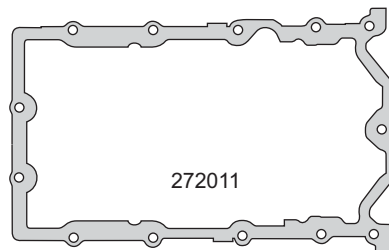
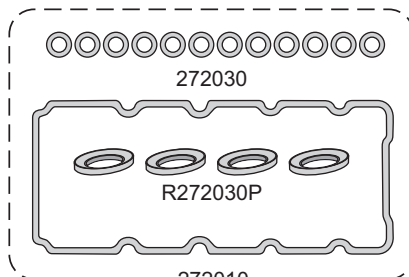
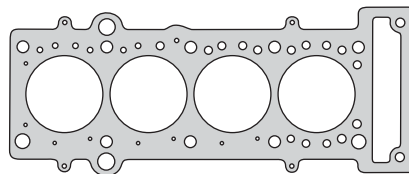

FIAT / ALFA ROMEO

FIAT



Motor/Engine Cm³ HP Ø

E.torQ
(SOHC) 16V **1747** **130** **81**

Fiat: Punto - Idea - Linea 2011/..



Nº OE	Descripción/Description	Mat.			Ref.
	Jgo. de juntas para motor			●	272100-R MLS
	Jgo. de juntas superior (MLS)		●		272195 MLS
55231762	Jta. tapa cilindros Ø 82 ± 0.60	MLS	1	1	272108
55223509	Jgo. de tornillos para tapa de cilindros				B272000
55224544	Conj. junta tapa válvulas (17)	GS	1	1	272010
55226126	Junta para cárter	NFT		1	272011
	Junta para cárter	PLAST			272111
55224457	Múltiple escape	AC	1	1	272015
7087745	Jgo. múltiple admisión (5)	S	1	1	272017
55227126	Guarnición frente motor bomba aceite	P			272027
	Arandela junta tapa válvulas	GS	12	12	272030
55224542	Retén capuchón bujías	P	4	4	R272030P
7087746	Guarnición cuerpo mariposa	P	1	1	272032
46824135	Guarnición sensor temperatura	GS	1	1	270533
7087876	Guarnición entrada aceite a bba G 27 x 32.5 x 4.5	P		1	272034
7087877	Guarnición salida aceite a bba G 22.5 x 27.5 x 5.5	P		1	272035
55231652	Guarnición base filtro aceite	GS			272037
55229989	O´ring G 12.37 x 2.62	GS			
55229787	O´ring G 20.30 x 2.62	GS			
	O´ring inyector G 10 x 2	V		4	
	Kit de retenes completo				R272000
55223481	Jgo. retén válvulas (16)	P	1		R272010P
55223567	Retén bancada trasera 91 x 111 x 10	V	1		R330511V
	Retén distribución 32 x 45 x 6.5	P	1		R230412P
55224542	Retén árbol de levas 40 x 55 x 7	V	1		R270713V

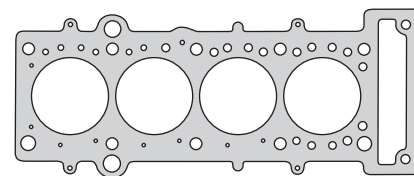

272108

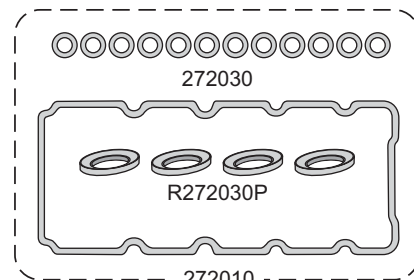

272030

R272030P

272010

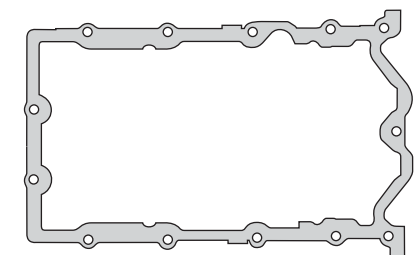

272011 - 272111

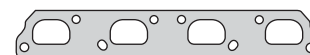

272015

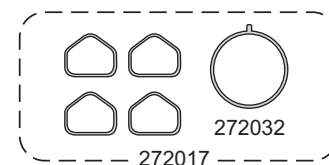

272032

272017

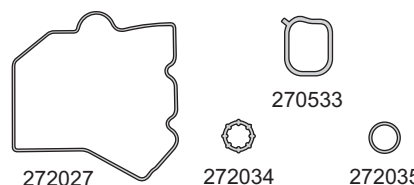

272027

272034

272035

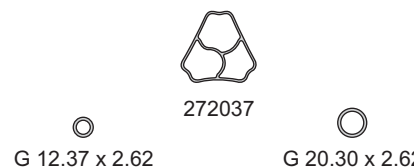

272037

G 12.37 x 2.62

G 20.30 x 2.62



G 10 x 2

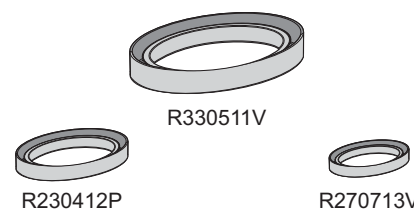

R330511V

R230412P

R270713V



R272010P

FIAT



Motor/Engine	Cm³	HP	Ø
Fire EVO	999	73/75	70

Fiat: Palio - Siena Generación III Uno Fase II 2010/...



Nº OE	Descripción/Description	Mat.	Ref.
7087532	Jgo. de juntas para motor		272200-R MLS
	Jgo. de juntas superior (MLS)		272295 MLS
55190882	Jta. tapa cilindros Ø 72.5 ± 0.60 N.R.	MLS 1 1	272208
7696197	Jgo. tornillos tapa cilindros (HAS13038)		B270500
55222898	Junta tapa válvulas	GS 1 1	271910
46745223/1	Junta para cárter	CG 1 1	270711
7084019	Tapa distribución	NB 1 1	270712
	Bomba de agua	NH	251014
55194291	Múltiple escape (2)	AC 1 1	271915
71716583	Jgo. múltiple admisión (5)	GS 1 1	270517
7604488	Base termostato	NB 1 1	270519
14463580	O´ring bomba de agua a block G 29.74 x 3.53	GS 1 1	271219
46549928	Guarnición goma	GS 1 1	270532
46824135	Conexión sensor temperatura	GS 1 1	270533
7086127/1	Guarnición anillo válvula	S	270534
7082509	O´ring de válvulas G 28.17 x 3.53	GS 1	
	O´ring de válvulas G 7.52 x 3.53	GS 1	
	Kit de retenes completo		R272200
55190344	Jgo. retén válvulas (8)	V 1	R271210V
5210858	Porta retén bancada trasera	VF	PR271911VF
55206525	Retén árbol de levas 31 x 55 x 7	V 1	R272213V
46404094	Retén bomba de aceite 27 x 37 x 7	V 1	R270515V

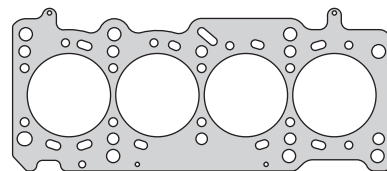

272208

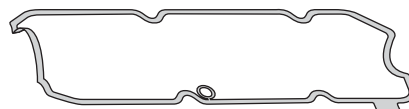

271910

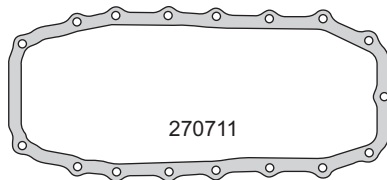

270711

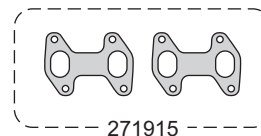

271915



270517/1 270532
270517

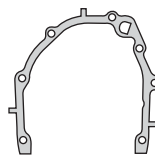

270712



251014



270519



271219



270534



270533



G 28.17 x 3.53



G 7.52 x 3.53

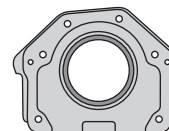

PR271911VF



R272213V



R270515V

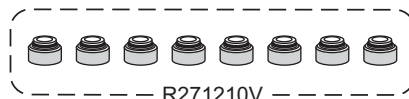

R271210V

FIAT / ALFA ROMEO



MOTORES NAFTA - DIESEL

300005 - 300006 - 300007

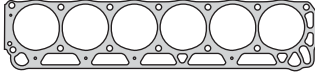

Código	Ø	Δ	Kit Bulón
300005	96.7	1.40	B300000
300006	96.7	2.40	
300007	96.7	1.40	

Modelo	Motor
Falcon - F100 - Fairlane 1969/... - Falcon SP - Sprint 1973/...	3052cc. 187 - 7B 108HP Ø90.62 - 3075cc. 188 - 7B 108HP Ø93.47 3618cc. 221 - 7B 108HP Ø93.47 (300000-R) pág. 203 3618cc. 221 - Sprint 7B 132HP Ø93.47 (300100-R) pág. 204

300205

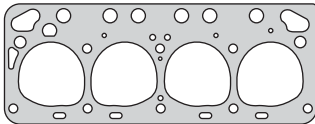

Código	Ø	Δ	Kit Bulón
300205	97.0	1.40	

Modelo	Motor
F100 - 350 - 600 - Fairlane 1961/70	4458cc. 272 V8 F1 170HP Ø92 4785cc. 292 V8 F1 170HP Ø95.25 (300200-R) pág. 205

300305

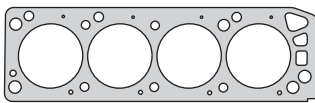

Código	Ø	Δ	Kit Bulón
300305	91.1	1.40	B300300

Modelo	Motor
Taurus L - GXL - Ghia 1974/...	1990cc. OHC 63HP Ø89.32 (300300-R) pág. 206

300405 - 300407

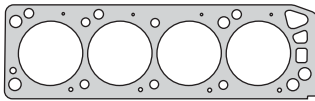

Código	Ø	Δ	Kit Bulón
300405	98.0	1.40	B300300
300407	98.0	1.40	

Modelo	Motor
Taurus - Sierra - XR4 - Falcon 1974/... - GXL/GT - SP/Ghia Maverick 1975/79 - Mustang 1980/... - Ranger - Pinto - Taurus Sierra - Capri - Granada 1974/86	2299cc. OHC 100/114HP Ø96 (300400-R) pág. 207 1993cc. L4 122 72HP - 2302cc. L4 140 86HP Ø96 (303600-R) pág. 235

300505

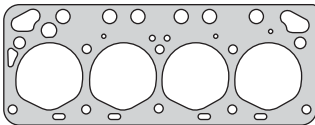

Código	Ø	Δ	Kit Bulón
300505	98.0	1.40	

Modelo	Motor
F100 - 350 - 600 - Fairlane 1/8 - LTD 500 - Fase II 1969/76	4785cc. V8 FII 180HP Ø95.25 (300500-R) pág. 208

300605

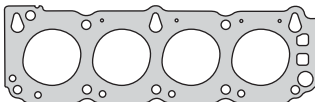

Código	Ø	Δ	Kit Bulón
300605	83.5	1.40	B300600 (HAT55055) (HAT55100)

Modelo	Motor
Sierra 1.6L 1984/...	1597cc. OHC 75HP Ø81.3 (300600-R) pág. 209

300705 - 300707

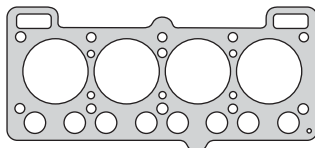

Código	Ø	Δ	Kit Bulón
300705	78.0	1.40	B300700 (HAS17038)
300707	78.0	1.40	

Modelo	Motor
Escort - Saveiro - Gol - Corcel II - Del Rey - Scala Pampa 1983/... - Belina - Verona 1989/...	1555cc. CHT/AE 73HP Ø77 (300700-R) pág. 210

300805

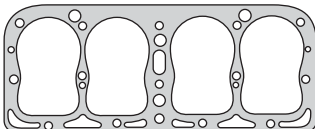

Código	Ø	Δ	Kit Bulón
300805	100.5	1.65	

Modelo	Motor
A - AA 1928/31	2100cc. 24HP Ø98.4 (300800) pág. 211

300905

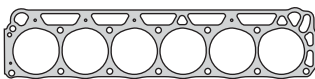

Código	Ø	Δ	Kit Bulón
300905	94.0	1.40	B300000

Modelo	Motor
Falcon 4B - STD - De Luxe - Futura - Rural 1962/68	2780cc. 170 4B 84HP Ø88.9 3052cc. 187 4B 96HP Ø90.42 (300900-R) pág. 212

301007

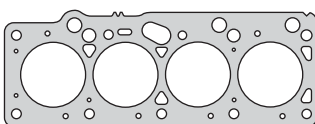









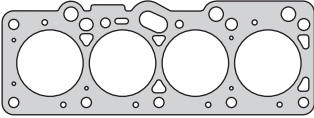

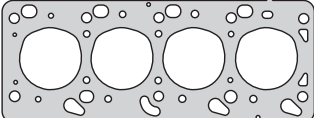

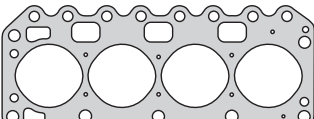
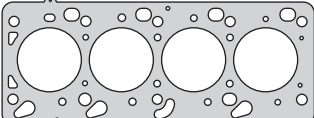

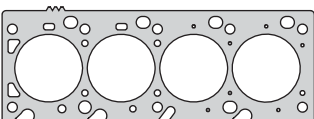

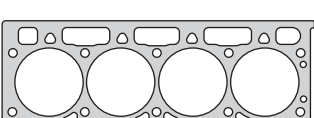

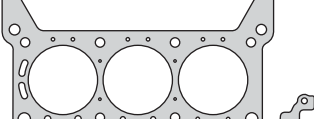
Código	Ø	Δ	Kit Bulón
301007	80.0	1.70	B301000 (HAS13038)

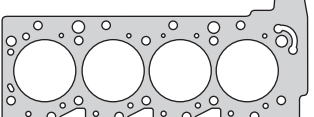
Modelo	Motor
Escort 1986/98 - Orion 1986/94	1392cc. HL14G/CFI/EFI 73/75HP Ø77.2 (301095-R) pág. 213

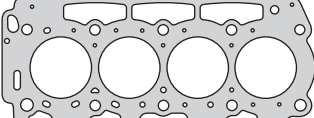

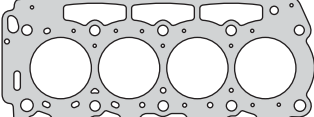







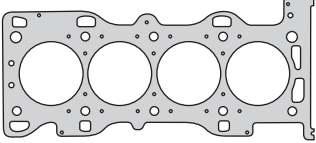



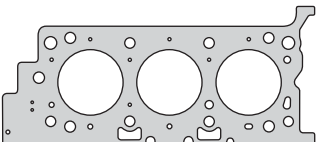

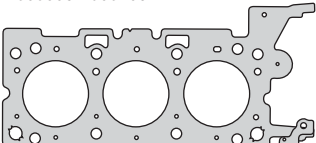

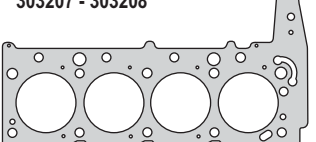

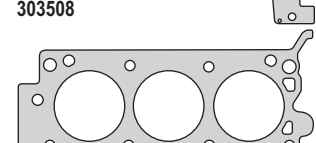

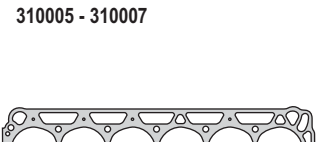

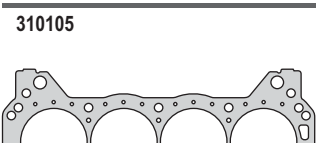

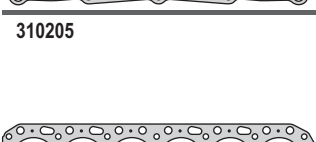

MOTORES NAFTA - DIESEL

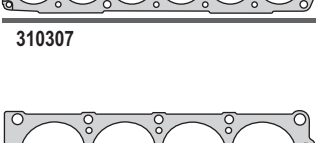
	301107 Código	\varnothing 83.0	Δ 1.70	Kit Bulón B301000	Modelo Fiesta i - Orion i 1989/92 - Escort XR3 1980/85 Fiesta XR2 1984/85 - Escort XR3i 1985/90
	Motor 1597cc. CHV (HL16CFI) 90HP - CVH (H16G/MFI) - CVH (HL16H) 79HP CVH (HL16I) 105HP - CVH (HL16G/H) 79/96HP \varnothing 80 (301100-R)  pág. 214				
	301207 Código	\varnothing 77.5	Δ 1.60	Kit Bulón B320300 (HAT55055) (HAT55100)	Modelo Mondeo 1993/... Escort - Orion 1992/... - Fiesta 1994/95
	Motor 1597cc. ZETEC 16V 90HP \varnothing 76 (301200-R)  pág. 215 1597cc. ZETEC 16V 90HP \varnothing 76 (301400-R)  pág. 216				
	301307 Código	\varnothing 77.0	Δ 1.20	Kit Bulón	Modelo Fiesta 1976/88 - Escort 1982/88 - Combi Van
	Motor 957cc. OHV (HCS) 40/45HP - 1118cc. OHV (HCS) 53/55HP \varnothing 73.96 1297cc. OHV (BL13H) 60HP \varnothing 73.96				
	301507 - 301508 Código	\varnothing 81.7 81.5	Δ 1.20 1.20	Kit Bulón B320300 (HAT55055) (HAT55100)	Modelo Focus 1998/... - Transit 2002/...
	Motor 1796cc. ZETEC E (DOHC) 16V 116HP \varnothing 80.6 (301500-R)  pág. 217 1796cc. ZETEC E-SFI (DOHC) 16V 116HP \varnothing 80.6 (303300-R)  pág. 233				
	301607 - 301608 Código	\varnothing 87.0 86.0	Δ 1.20 0.65	Kit Bulón B320300 (HAT55055) (HAT55100)	Modelo Focus 1999/02 Focus 1999/02 - Maverich 2000/... - Cougar 1999/...
	Motor 1989cc. ZETEC E 16V 131HP \varnothing 84.5 1989cc. YF/EDBA/EDBB/EDBC/EDBD (DOHC) 16V 124/131HP \varnothing 84.8 (302900-R)  pág. 229				
	301705 Código	\varnothing 96.2	Δ 1.20	Kit Bulón	Modelo Ghia 1991/... - Topaz 1989/94
	Motor 2300cc. 140 F.I (301700-RMX)  pág. 218 2300cc. 140 Carburado (301800-RMX)  pág. 219				
	301905 - 301907 Código	\varnothing 99.0 99.0	Δ 1.20 1.20	Kit Bulón	Modelo V6 3.8 (USA) Mustang - Taurus - Sable - Thunderbird - Cougar 1985/87
	Motor 3811cc. 232 V6 130HP \varnothing 96.8 (301900-RMX)  pág. 220				
	302007 - 302008 Código	\varnothing 91.0 91.0 91.0 91.0 91.0 91.0	Δ 1.10 1.15 1.20 1.10 1.15 1.20	Kit Bulón B322000	Modelo Transit TD 2000/...
	Motor 2402cc. Duratorq 120/125HP \varnothing 89.9 - DIESEL (302001-R)  pág. 221 (DOHC) 16V				
	302107 Código	\varnothing 75.0 75.0 75.0 75.0 75.0	Δ 1.20 1.30 1.40 1.45 1.50	Kit Bulón B322100 (HAE14038)	Modelo Fiesta - Eco Sport TD 2003/... - Duratorq TDCI
	Motor 1398cc. F6JA - F6JB 68HP (SOHC) \varnothing 74 - DIESEL (302101-R)  pág. 222				
	302108 Código	\varnothing 75.0 75.0 75.0 75.0 75.0	Δ 1.25 1.30 1.35 1.40 1.45	Kit Bulón B322100 (HAE14038)	Modelo Fiesta - Eco Sport TD 2003/... - Duratorq TDCI
	Motor 1398cc. F6JA - F6JB 68HP (SOHC) \varnothing 74 - DIESEL (302101-R)  pág. 222				

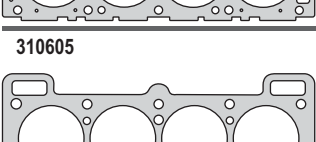









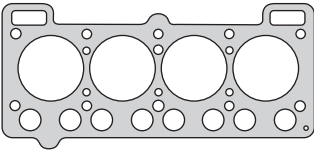



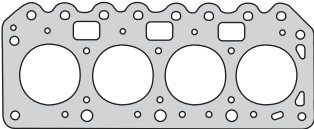



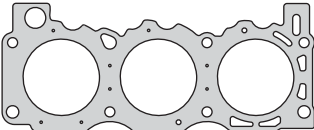



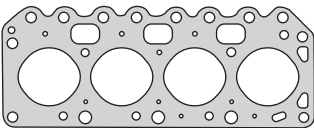



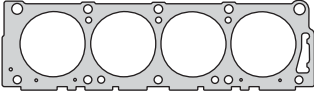



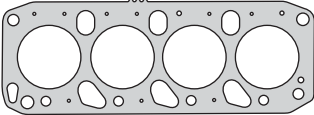



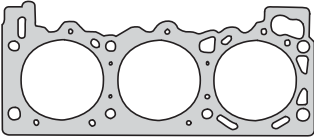



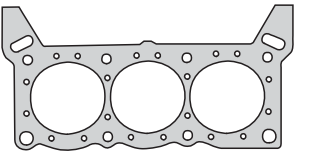



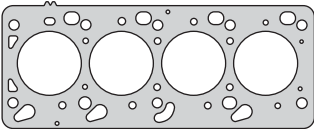

MOTORES NAFTA - DIESEL

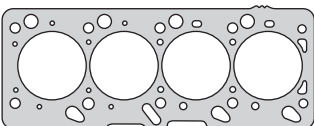
	302207 - 302208	Código	Ø	⊘	Kit Bulón	Modelo	Mondeo 2001/... - Eco Sport 2003/... - Ranger 2001/... Maverick 2003/... - Focus - Focus EXE
		302207 302208	89.0 89.0	1.20 0.40	B302200  (HAT55055) (HAT55100)	Motor	1999cc. CJBA - Duratec HE 145/143HP Ø87.5 (302200-R)  pág. 223 1999cc. CJBA 145HP - Duratec HE 143HP Ø87.5 (302400-R)  pág. 225 2261cc. 154HP Ø87.5 (302400-R)  pág. 225
	302507 - 302508	Código	Ø	⊘	Kit Bulón	Modelo	Mystique - Contour 1995/00 - Mondeo 1994/00 - Mondeo III 2000/...
		302507 302508	84.0 83.0	1.60 0.85		Motor	2475cc. Duratec - LCBD V6 24V (DOHC) 170HP Ø81.6 2495cc. Duratec - LCBD V6 24V 170HP Ø81.6 (302500-R)  pág. 226
	303008 - 303108	Código	Ø	⊘	Kit Bulón	Modelo	Mondeo II 1994/00 - Mondeo V6 - ST 2.20 2003/...
		303008 303108	83.5 91.5	0.85 0.85	B302500	Motor	2544cc. Duratec SEA (DOHC) 24V 170/173HP Ø82.4 (303000-R)  pág. 230 2967cc. Duratec V6 - MEBA (DOHC) 24V 226HP Ø89 (303100-R)  pág. 231
	303207 - 303208	Código	Ø	⊘	Kit Bulón	Modelo	Mondeo TDCI 2000/02 - 2002/... - Mondeo III DI 2002/02 Transit TDI-TDCI 2000/02 - 2002/... - Transit DI 2000/02
		303207-1M 303207-2M 303207-3M 303208-1M 303208-2M 303208-3M	87.0 87.0 87.0 87.0 87.0 87.0	1.10 1.15 1.20 1.10 1.15 1.20	B302000	Motor	1998cc. HJBA/B/C 85HP - F3FA 85HP - F1FA 125HP - ABFA 100HP - D3FA 75HP - D5BA 90HP - D6BA 115HP (DOHC) 16V Duratorq Ø86 - DIESEL (303201-R)  pág. 232
	303508	Código	Ø	⊘	Kit Bulón	Modelo	Mondeo III 2002/...
		303508	83.0	0.80		Motor	2495cc. AJ25 - LDBE V6 (DOHC) 24V 170HP Ø81.6 (303500-R)  pág. 234
	310005 - 310007	Código	Ø	⊘	Kit Bulón	Modelo	Falcon - Pick Up 1989/...
		310005 310007	96.7 96.7	1.40 1.40	B300000	Motor	3618cc. Max Econo 106HP Ø93.47 (310000-R)  pág. 236
	310105	Código	Ø	⊘	Kit Bulón	Modelo	Ranger 1989/... - Galaxy - Maverick 1976/83 - Galaxy 500 - Fairlane - Falcon Maverich - Mustang - Grand Marquis - F150 - F250 1965/84
		310105	104.0	1.40		Motor	4942cc. F302 - V8 Ø101.6 (310100)  pág. 237 4300cc. 260 V8 Ø96 - 4800cc. 289 V8 16V Ø96 (321800-RMX)  pág. 261 5000cc. 302 V8 16V Ø96 (321800-RMX)  pág. 261
	310205	Código	Ø	⊘	Kit Bulón	Modelo	Econoline - Delivery 1980/...
		310205	107.0	1.70		Motor	4900cc. 145HP Ø101.09 (310200-R)  pág. 238
	310307	Código	Ø	⊘	Kit Bulón	Modelo	Fairlane 500 - Galaxy 500 - Monterey - Thunderbird - Mustang 1960/71
		310307	109.0	1.20		Motor	5400cc. 390 CID V8 Ø102 (310300)  pág. 239
	310605	Código	Ø	⊘	Kit Bulón	Modelo	Corcel II 1979/83 - Belina II - Pampa 1982/83 Del Rey 1981/83 - Scala 1983/... - Belina - Coupe GT 1.4 BR
		310605	78.0	1.40	B300700  (HAS17038)	Motor	1555cc. CHT 73HP Ø77 (310600-R)  pág. 240 1300cc. CHT 73HP Ø77 - 1400cc. CHT Ø77 (320600-R)  pág. 252





MOTORES NAFTA - DIESEL

 310705	Código 310705	Ø 73.0	 1.40	Kit Bulón B300700  (HAS17038)	Modelo Escort Hobby 1.0 1993/... - Escort 1.3 1983/...
	Motor 997cc. CHT/AE Ø70.3 1300cc. CHT/AE Ø71.5 (310700-R)  pág. 241				
 310805 - 310807	Código 310805 310807	Ø 76.0 76.0	 1.40 1.40	Kit Bulón B310800  (HAS14038)	Modelo Fiesta 1988/95 - Courier 1991/... (cárter de aluminio) Ka (cárter de acero) - Escort - Ka (cárter de aluminio) 1995/...
	Motor 1297cc. OHV (HCS) Endura 60HP Ø73.96 1299cc. OHV (HCS) Endura 50/60HP Ø73.96 (310800-R)  pág. 242				
 310907	Código 310907	Ø 95.0	 1.40	Kit Bulón B310900  (HAT55055) (HAT55100)	Modelo Ford V6 (USA) Ranger - Bronco II 1988/92 Sierra V6 B4A/B/C 1989/93 - Granada BRC 1986/93
	Motor 2933cc. 177/BRC V6 150HP Ø93 (310900-R)  pág. 243				
 311005 - 311007	Código 311005 311007	Ø 70.5 70.5	 1.30 1.30	Kit Bulón B310800  (HAS14038)	Modelo Ka 1997/99 - Fiesta 1996/99 53HP - Fiesta 1988/95 45HP
	Motor 999cc. OHV (HCS) Endura 45/53HP Ø68.7 (311000-R)  pág. 244				
 311105	Código 311105	Ø 109.0	 1.20	Kit Bulón	Modelo Galaxie - Mustang - Torino 1964/78 - Camión 1964/78
	Motor 5400cc. 330 - 5900cc. 351 - 6400cc. 391 V8 (311100-RMX)  pág. 245 5400cc. 350 V8 (311200-R)  pág. 246				
 320007	Código 320007-2M 320007-3M 320007-4M	Ø 84.0 84.0 84.0	 1.40 1.45 1.50	Kit Bulón B320000  (HAT70100)	Modelo Fiesta - Courier - Orion D - Sierra TD Mondeo TD 1991/... - Escort TDI 1994/...
	Motor 1753cc. D1.8 T/TI 60/75/90HP Ø82.5 - DIESEL (320001-R)  pág. 247				
 320107	Código 320107	Ø 103.5	 1.40	Kit Bulón B310900  (HAT55055) (HAT55100)	Modelo Explorer - Ranger - Navajo V6 1991/... - Bronco II V6 1990/91
	Motor 3996cc. 244 CID V6 (SOHC) 147/165HP Ø100.4 (320100-R)  pág. 248				
 320207	Código 320207	Ø 99.7	 1.40	Kit Bulón	Modelo V6 3.8 (USA) Mustang - Taurus - Sable - Thunderbird - Cougar Windstar 1995/96
	Motor 3811cc. 230 (232) V6 130HP Ø96.8 (320200)  pág. 249 3797cc. 232 V6 200HP Ø97 (323200-R)  pág. 273				
 320307	Código 320307	Ø 81.7	 1.60	Kit Bulón B320300  (HAT55055) (HAT55100)	Modelo Orion - Fiesta XR2 - Escort RX3i 1992/... - Mondeo 1993/...
	Motor 1796cc. ZETEC 16V 105/115HP Ø80.6 (320300-R)  pág. 250 1796cc. ZETEC 16V 105/115HP Ø80.6 (321300-R)  pág. 258				
 320507	Código 320507	Ø 87.0	 1.70	Kit Bulón B320300  (HAT55055) (HAT55100)	Modelo Escort - Mondeo 1993/01
	Motor 1989cc. ZETEC 16V 136HP Ø84.8 (320500-R)  pág. 251 1989cc. ZETEC 16V (DOHC) 136HP Ø84.8 (321500-R)  pág. 259 1989cc. ZETEC 16V 126HP Ø83 (340800-R)  pág. 292				



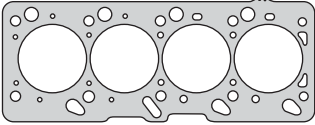
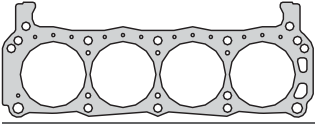
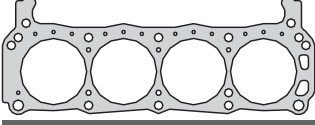
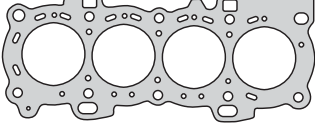
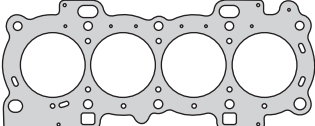
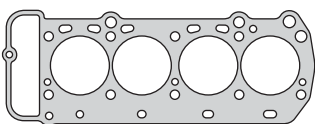
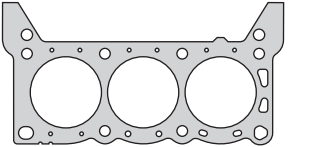

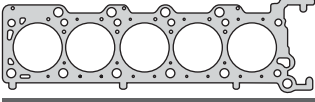
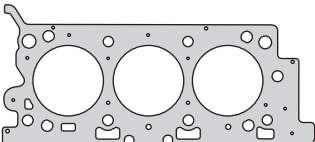





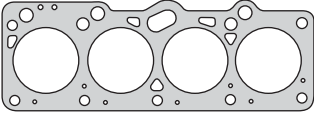
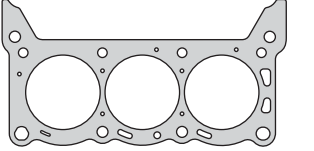





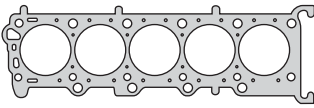

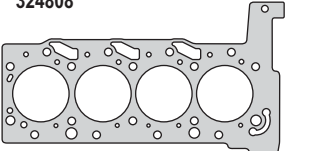

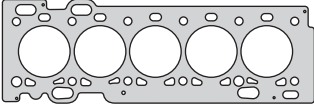

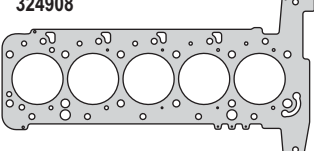

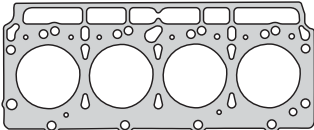

MOTORES NAFTA - DIESEL

320507 	Código	Ø	≠	Kit Bulón	Modelo
	320507	87.0	1.70	B320300 (HAT55055) (HAT55100)	Contour 1996/98, Mystique 1994/95, Escort ZX2 1998/... Contour 1994/...
320705 - 320707 	Código	Ø	≠	Kit Bulón	Modelo
	320705 320707	104.5 103.5	1.20 1.20		Cougar - Continental - Granada - Fairmont - Thunderbird F100 - F250 - F350 - Mustang - Thunderbird - Bronco 1983/96 F100 - F250 - F350 - Bronco 1985/95
320705 - 320707 	Código	Ø	≠	Kit Bulón	Modelo
	320705 320707	104.5 103.5	1.20 1.20		Cougar - Thunderbird - F200/F350 1991/95 - F250/F350/F600 - Microbus (Chasis) 1984/91- Grand Marquis - Galaxy - Camiones - Mustang F250/F350/FB600 1969/84
320907 - 320908 	Código	Ø	≠	Kit Bulón	Modelo
	320907 320908	78.0 77.0	1.50 1.40	B320900 (HAT55055) (HAT55100)	Fiesta SE - Courier - Puma 1996/...
321608 	Código	Ø	≠	Kit Bulón	Modelo
	321608	80.0	0.30	B320900 (HAT55055) (HAT55100)	Fiesta - Fusión 2003/... - Focus 2004/... - C-Max 2007/...
322205 	Código	Ø	≠	Kit Bulón	Modelo
	322205	82.0	1.20		Courier 1972/82
322307 	Código	Ø	≠	Kit Bulón	Modelo
	322307	99.0	1.30		Thunderbird - Cougar Super Cargado 1988/93
322405 	Código	Ø	≠	Kit Bulón	Modelo
	322405	95.0	1.30		Bronco - Granada - Capri 1983/86
322708 	Código	Ø	≠	Kit Bulón	Modelo
	322708	92.0	0.88		Triton F-450 V10 1997/99 - 2000/03 F-450 - Excursion - E-Series - F-Series Super Duty
322908 	Código	Ø	≠	Kit Bulón	Modelo
	322908	91.5	0.90		Escape 2001/04

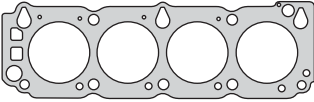

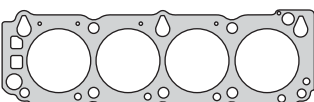



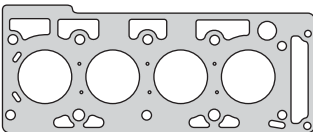
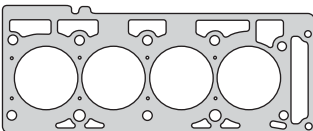
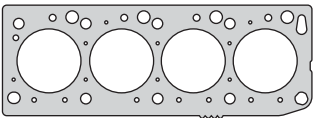

MOTORES NAFTA - DIESEL

	323107	Código	Ø	≠	Kit Bulón	Modelo	Escort 1997/01
	323107		86.0	1.20		Motor	2000cc. 8V 110
	323307	Código	Ø	≠	Kit Bulón	Modelo	Windstar 1997/98 - Windstar 1998/... Windstar 1999/00 - 2001/03 - Econoline - F150 1997/98
	323307		100.0	1.20		Motor	3797cc. Essex V6 155HP Ø96.8 (323300-R)  pág. 274 (323900-R)  pág. 276 3797cc. Essex V6 200HP Ø96.8 (324000-R)  pág. 277 (324100-R)  pág. 278 4195cc. Essex V6 202HP Ø96.8 (324400-R)  pág. 280
	323707	Código	Ø	≠	Kit Bulón	Modelo	Camioneta Ranger 1996/01
	323707		91.5	1.20		Motor	2968cc. Vulcan V6 147HP Ø89 (323700-R)  pág. 275
	324808	Código	Ø	≠	Kit Bulón	Modelo	Ranger XL 4X2 / 4X4 - Transit TDCi 2006/...
	324808-1M		87.1	1.10	B302000	Motor	2198cc. Puma TDCi 125HP - CVRA/CVRB/CVRC/CYFA/CYFB/CYFC/CYFD CYRA/CYRB/CYRC 125/155HP - DRFA/DRFB/DRFC/DRFD/DRFE/DRRA SRFB/SRFA/SRFC/SRFD/SRFE 115HP Ø86 DIESEL (302001-R)  pág. 282
	324808-2M		87.1	1.15			
324808-3M		87.1	1.20				
	324708	Código	Ø	≠	Kit Bulón	Modelo	Focus - C-Max - S-Max - Mondeo - Kuga 2005/..., 2007/...
	324708		84.0	1.30		Motor	2522cc. Duratec (25KDDTD) - Duratec-VCT (25KDDTD) 220/226/300HP Ø83 (324700-R MLS)  pág. 281
	324908	Código	Ø	≠	Kit Bulón	Modelo	Ranger XLS/XLT 4X2 - 4X4 TDCi 2013/...
	324908-1M		91.0	1.10		Motor	3198cc. Puma TDCi I5 eTGV 200HP Ø90 DIESEL (324901-R)  pág. 283
	324908-2M		91.0	1.15			
324908-3M		91.0	1.20				
	330307	Código	Ø	≠	Kit Bulón	Modelo	Transit D/DI 1985/99
	330307 330307-1.20		96.0 96.0	1.40 1.20	B330300  (HAS17038)	Motor	2496cc. 4EB/BC/CA/FB 70/80HP - 4HC/EA 100HP Ø93.64 - DIESEL (330300-R)  pág. 284
	330607	Código	Ø	≠	Kit Bulón	Modelo	F100 GMC Turbo 1999/...
	330607 330607-1.70		96.0 96.0	1.40 1.70	B330600  (HAS17038)	Motor	4200cc. Sprinter 6.07 TD 167HP Turbo Intercooler 198HP Ø93 DIESEL (330600-R)  pág. 320
	330905	Código	Ø	≠	Kit Bulón	Modelo	Capri - Cortina - Sierra - Transit - Pick Up - Granada 1973/...
	330905		90.0	1.40	B300600  (HAT55055) (HAT55100)	Motor	1593cc. OHC TL16L/TL16H/TL16G 63/73/90HP Ø87.65
	340005	Código	Ø	≠	Kit Bulón	Modelo	Granada - Transit - Escorpio - Sierra - Capri - Taunus 1970/...
	340005		93.0	1.40	B300600  (HAT55055) (HAT55100)	Motor	1993cc. OHC TL20L/H 102/105HP Ø91

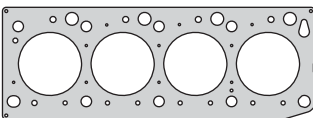

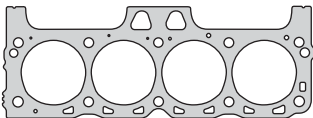
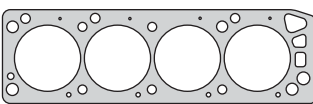
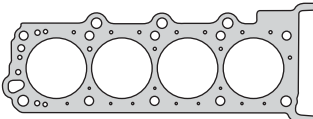
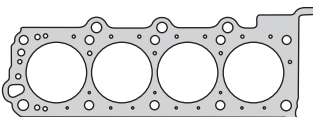
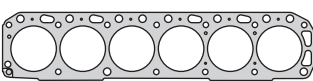
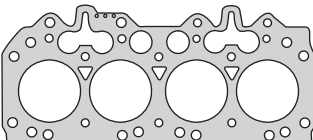
MOTORES NAFTA - DIESEL

340107 - 340108 	Código	Ø	≡	Kit Bulón	Modelo
	340107 340108	70.0 70.0	1.20 0.35	B340100	Ka 1999/...
340207 - 340208 	Código	Ø	≡	Kit Bulón	Modelo
	340207 340208	83.0 83.0	1.20 0.35	B340100	Ka 1997/... - Fiesta 1999/... - Escort - Eco Sport 2003/...
340307 	Código	Ø	≡	Kit Bulón	Modelo
	340307-1M 340307-2M 340307-3M 340307-4M	84.0 84.0 84.0 84.0	1.20 1.30 1.40 1.50	B340300 (HAT60100) (HAT60055)	Focus TD di 1998/... - Focus di 1999/... - Fiesta TD di 2000/... Focus TD ci 2001/...
					Motor
					1753cc. Lynx (C9DC) 75/90HP Duratorq 115HP - BHDA/BHDB 75HP Ø82.5 DIESEL (340301-R)  pág. 287
340308 	Código	Ø	≡	Kit Bulón	Modelo
	340308-2M 340308-3M 340308-4M 340308-5M 340308-6M 340308-7M	83.5 83.5 83.5 83.5 83.5 83.5	1.20 1.25 1.30 1.35 1.40 1.42	B340300 (HAT60100) (HAT60055)	Focus TD di 1998/... - Focus di 1999/... - Fiesta TD di 2000/... Focus TD ci 2001/...
					Motor
					1753cc. Lynx (C9DC) 75/90HP Duratorq 115HP - BHDA/BHDB 75HP Ø82.5 DIESEL (340301-R)  pág. 287
340407 - 340507 	Código	Ø	≡	Kit Bulón	Modelo
	340407 340507	114.0 114.0	1.30 1.30		F100 - F250 - F350 - Econoline 250/350 1985/87 Monterey - Torino - Cougar - Continental - Mark III - IV - V 1988/94
340607 	Código	Ø	≡	Kit Bulón	Modelo
	340607	100.0	1.30	B300300	Mustang - Ranger 1993/94 - Ranger 1995/97 - Pick Up 1989/... Pick Up - Ranger 1997/...
340707 - 340708 	Código	Ø	≡	Kit Bulón	Modelo
	340707 340708	93.0 92.0	1.30 0.88		E-Series - Mustang - Grand Marquis - Crown Victoria Pick Up F250 1997/99 - 2000/03
340707 - 340708 	Código	Ø	≡	Kit Bulón	Modelo
	340707 340708	93.0 92.0	1.30 0.88		E-Series - F-Series - Expedition - Triton 1997/99 - 2000/03 Town Car 1991/95 - Grand Marquis 1993/95 - LTD Crown - Victoria 1992/... Cougar - Thunderbird 1994/95
340907 	Código	Ø	≡	Kit Bulón	Modelo
	340907	105.5	1.20		F100 - F150 1991/...
430007 - 430008 	Código	Ø	≡	Kit Bulón	Modelo
	430007-1M 430007-2M 430007-3M 430007-4M 430008-1M 430008-2M 430008-3M	92.0 92.0 92.0 92.0 92.0 92.0 92.0	1.37 1.48 1.59 1.70 1.30 1.40 1.50	B430000 (HAS19038)	Ranger TDI 1995/...
					Motor
					2507cc. 95HP Ø90.7 - DIESEL (430001-R)  pág. 314



MOTORES NAFTA - DIESEL

430607 - 4730608

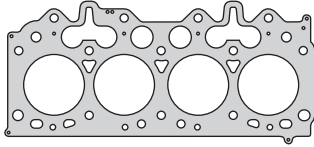

Código	Ø	≠	Kit Bulón
430607-1M	94.0	1.37	B430600 (HAS19038)
430607-2M	94.0	1.48	
430607-3M	94.0	1.59	
430607-4M	94.0	1.70	
430608-1M	94.0	1.30	
430608-2M	94.0	1.40	
430608-3M	94.0	1.50	

Modelo	Ranger TD BR 2000-2002/....
Motor	2758cc. Power Stroke 135HP Ø93 - DIESEL (430001-R) pág. 315

430807 - 430808

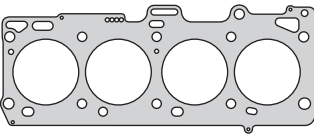

Código	Ø	≠	Kit Bulón
430807/8-1M	98.0	1.30	B430800 (HAT60055) (HAT60100)
430807/8-2M	98.0	1.40	
430807/8-3M	98.0	1.50	
430807/8-4M	98.0	1.60	

Modelo	Ranger 3.0I - 4 x 4 - Full BR Intercooler
Motor	3000cc. Maxion TD (SOHC) Ø96 - DIESEL (430801-R) pág. 316

471307

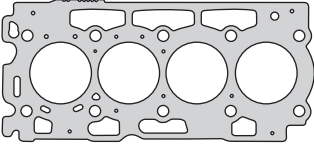

Código	Ø	≠	Kit Bulón
471307-1M	76.0	1.20	B302100 (HAE14038)
471307-2M	76.0	1.30	
471307-3M	76.0	1.40	
471307-4M	76.0	1.45	
471307-5M	76.0	1.50	

Modelo	Focus C-Max TDCI 2003/..., Fusion TDCI 2004/...
Motor	1560cc. G8DA 90HP - Duratorq 109HP (DOHC) 16V Ø75 - DIESEL (471301-R) pág. 385

471408

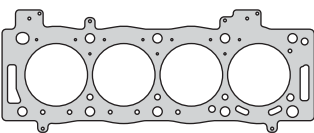

Código	Ø	≠	Kit Bulón
471408-1M	86.0	1.25	B470800 (HAE14038)
471408-2M	86.0	1.30	
471408-3M	86.0	1.35	
471408-4M	86.0	1.40	

Modelo	C-Max TDCI 2003/... - Focus TDCI, Galaxy TDCI - S-Max 2006/... Mondeo TDCI - C-Max TDCI - Focus TDCI 2007/... Focus C-Max TDCI 2003/...
Motor	1998cc. DURATORQ (20DD0X) 110/115/130/135/140HP Ø85 (DOHC) 16V DIESEL (471401-R) pág. 386 1998cc. G6DA/G6DC 135HP Ø85 - DIESEL (471501-R) pág. 387

870007

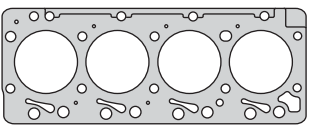

Código	Ø	≠	Kit Bulón
870007	106.0	1.60	B870000

Modelo	F100 1998/...
Motor	3900cc. 4B - 4BT - 4BTA 100/130HP Ø102 DIESEL (870000-R) pág. 15

870508

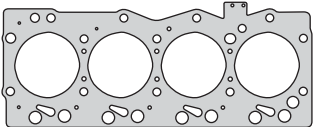

Código	Ø	≠	Kit Bulón
870508	105.0	1.10	B870500

Modelo	Transit D/DI 1985/99
Motor	3900cc. ISBe 150HP Ø102 DIESEL (870500-R) pág. 21

910507

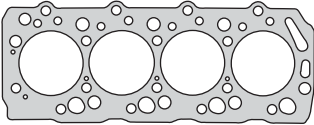

Código	Ø	≠	Kit Bulón
910507	92.0	1.70	B910500 (HAH10055) (HAH10140)

Modelo	Bronco II TD - Ranger 2WD 1985/...
Motor	2346cc. 4D55T 67HP Ø91 - DIESEL (910500-R)

920208

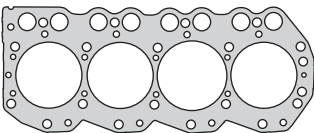

Código	Ø	≠	Kit Bulón
920208	97.8	1.58	B920200

Modelo	Maverick TD 1992/99
Motor	2663cc. TD27T 100/125HP Ø96 - DIESEL (920200-R)

971607

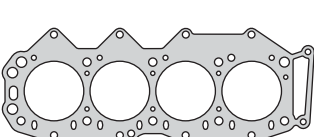

Código	Ø	≠	Kit Bulón
971607	94.3	1.30	

Modelo	Ranger D/TD 1998/...
Motor	2499cc. WL 78HP WLT 108HP Ø93 - DIESEL

971907

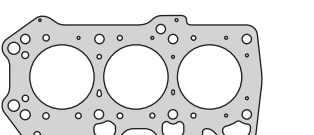

Código	Ø	≠	Kit Bulón
971907	85.5		B971900

Modelo	Probe 1992/95
Motor	2497cc. KL 170HP (DOHC) V6 24V Ø84.5

FORD**taranto**

Motor/Engine	Cm³	HP	Ø
187 - 7B	3052	108	90.62
188 - 7B	3075	108	93.47
221 - 7B	3618	108	93.47

Ford: Falcon - F100 - Fairlane 1969/...

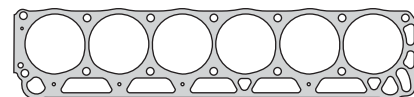

300005



300010

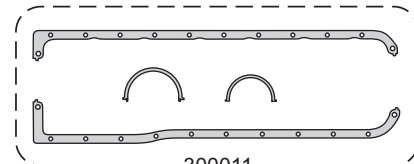

300011

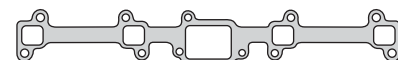

300015/16

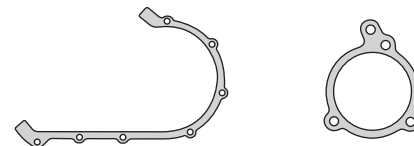

300012

300014

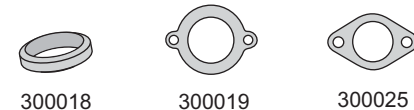

300018

300019

300025



300125

300026

300027

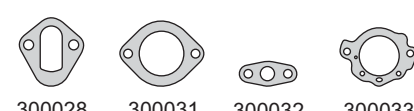

300028

300031

300032

300033

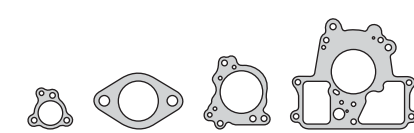

300034

300035

300037

300038

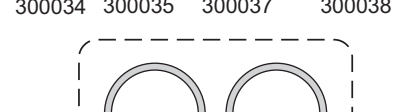

300058

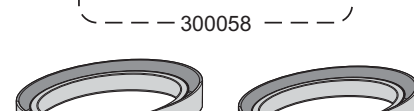

R300011P

R300911P



R300012P

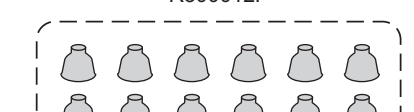

R300010-1P



R300010P

Nº OE	Descripción/Description	Mat.	Ref.
	Jgo. de juntas para motor		300000-R
	Jgo. de juntas superior		300095
BAD3DZ6051A	Jta. tapa cilindros Ø 96.7 \pm 1.40	NFT 1 1	300005
	Jta. tapa cilindros Ø 96.7 \pm 2.40	NFT	300006
BAD3DZ6051A	Jta. tapa cilindros Ø 96.7 \pm 1.40 N.R.	NFT	300007
	Jgo. de tornillos para tapa de cilindros		B300000
CODE6584B	Junta tapa válvulas superior	CG 1 1	300010
BAC9DZ6781A	Jgo. junta para cárter (4)	CG 1	300011
BAC9DZ6020A	Tapa distribución	NB 1	300012
CODE8507A	Bomba de agua	NB 1	300014
BAC8DZ9448A	Múltiple admisión y escape (fondo chapa)	FCH 1	300015
BAC8DZ9448A	Múltiple admisión y escape	NFT 1	300016
C6AZ9450D	Salida de escape	NFT 1 1	300018
CODE8255A	Salida agua termostato	CB 1 1	300019
BAC9AZ9502A	Jgo. juntas carburador HOLLEY M/188	VS	300020
BAC9AZ9502A	Jgo. juntas carburador HOLLEY M/221	VS	300120
BAD3DZ9502A	Jgo. juntas carburador GALILEO M/188	VS	300021
BAD3DZ9502A	Jgo. juntas carburador GALILEO M/221	VS	300121
BAE2DZ9502A	Jgo. juntas carburador HOLLEY ARGELITE	VS	300022
BAE2DZ9502A	Jgo. juntas carburador HOLLEY ARGELITE s/sep.	VS	300023
BAC4DZ9447A	Base carburador M/188	NB 1 1	300025
BAC9DZ9447B	Base carburador M/221	NB 1 1	300125
	Tapa cuba HOLLEY	CG	300026
	Bomba aceite	NB 1	300027
C3AZ9417C	Bomba nafta	NB 1	300028
BAC9DZ9447A	Base calefactor	NB 1 1	300031
CODE6626A	Cañería aceite	NB 1	300032
	Intermedia HOLLEY 188/221	NB	300033
	Válvula potencia	CB	300034
	Base carburador HOLLEY ARGELITE	NB	300035
	Intermedia HOLLEY ARGELITE	NB	300037
	Tapa carburador HOLLEY ARGELITE	CB	300038
	Salida escape	AC	300040
	Jgo. juntas caja velocidades FAE	VS	300050
	Jgo. juntas caja velocidades 3.03 1ra. Serie	VS	300051
	Jgo. juntas caja velocidades TRANSAX	VS	300052
	Plato freno a diferencial	CB	300056
	Apoyo retén ruleman	CB	300057
C9DZ6701A	Jgo. juntas empaquetadura bancada (2)	SNA	300058
BAC9DZ6781A	Jgo. juntas para cárter	CG	300060
CODE6584B	Tapa válvulas superior	CG	300061
	Porta retén ruleman palier	CB	300065
	Palier	CB	300069
	Junta tapa cilindros competición (0.60)	NFT	300090-0.60
	Junta tapa cilindros competición (0.80)	NFT	300090-0.80
	Junta tapa cilindros competición (1.00)	NFT	300090-1.00
	Junta tapa cilindros competición de lámina	AC	300090L
	Kit de retenes completo		R300000
	Jgo. retén válvulas (12)	P 1	R300010P
	Jgo. retenes válvulas capuchones (12)	P	R300010-1P
	Retén bancada 85.7 x 102.62 x 9.73	P 1	R300011P
	Retén reforma bancada 85.7 x 100 x 5.5	P 1	R300911P
	Retén distribución 44.45 x 60.3 x 11.11	P 1	R300012P

FORD



Motor/Engine	Cm³	HP	Ø
221 Sprint 7B	3618	132	93.47

Ford: Falcon SP - Sprint 1973/...



Nº OE	Descripción/Description	Mat.	Ref.
	Jgo. de juntas para motor		300100-R
BAD3DZ6051A	Junta tapa cilindros Ø 96.7 ± 1.40	NFT 1	300005
	Junta tapa cilindros Ø 96.7 ± 2.40	NFT	300006
BAD3DZ6051A	Junta tapa cilindros Ø 96.7 ± 1.40 N.R.	NFT	300007
	Jgo. de tornillos para tapa de cilindros		B300000
CODE6584A	Junta tapa válvulas superior	CG 1	300010
	Junta tapa válvulas 1986/...		300110
BAC9DZ6781A	Jgo. junta para cárter (4)	CG 1	300011
BAC9DZ6020A	Tapa distribución	NB 1	300012
CODE8507A	Bomba de agua	NB 1	300014
BAD3DZ9448A	Múltiple admisión y escape	NFT 1	300116
C6AZ9450D	Salida de escape	FCH 1	300418
CODE8255A	Salida termostato	CB 1	300019
BAC7TZ	Jgo. juntas carburador HOLLEY ARGELITE	VS	300122
BAX9DZ9447B	Base carburador M/221	NB 1	300125
BAD00Z9447A	Base carburador	NB 2	300225
	Cuba abierta HOLLEY	CG	300226
	Bomba aceite	NB 1	300027
C3AZ9417C	Bomba nafta	NB 1	300028
BAC9DZ9447A	Base calefactor	NB 1	300031
CODE6626A	Cañería aceite	NB 1	300032
	Tapa diferencial DANA 44	CG	540034
	Placa HOLLEY cerrada	CG	300237
	Intermedio carburador HOLLEY 2b	NB	300238
	Jgo. juntas caja velocidades TRANSAX	VS	300052
C90Z6701A	Jgo. juntas empaquetadura bancada (2)	SNA	300058
BAC9DZ6781A	Jgo. juntas para cárter	CG	300060
CODE6584B	Tapa válvulas superior	CG	300061
	Tapa diferencial dana 44	CGT	540068
	Kit de retenes completo		R300000
	Jgo. retén válvulas (12)	P 1	R300010P
	Jgo. retén válvulas capuchones (12)	P	R300010-1P
	Retén bancada 85.70 x 102.62 x 9.73	P 1	R300011P
	Retén reforma bancada	P 1	R300911P
	Retén distribución 44.45 x 60.3 x 11.11	P 1	R300012P

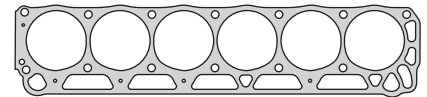

300005



300010

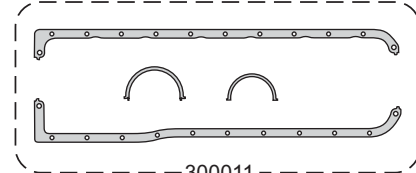

300011



300116

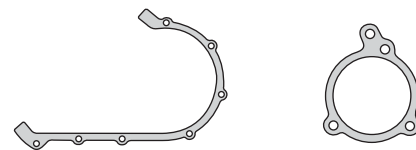

300012

300014

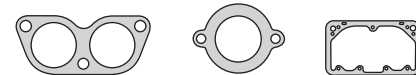

300418

300019

300226

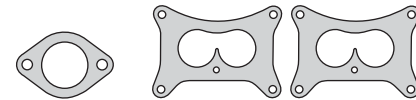

300125

300225

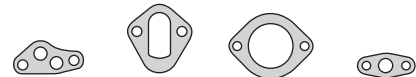

300027

300028

300031

300032

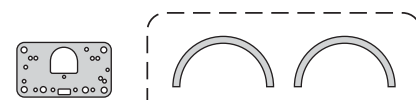

300237

300058

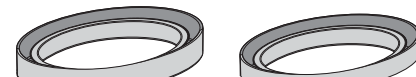

R300011P

R300911P



R300012P

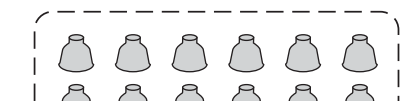

R300010-1P

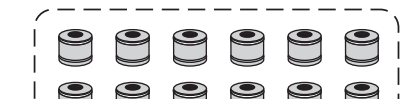

R300010P

FORD**taranto**

Motor/Engine

Cm³

HP

Ø

Ford: F100 - 350 - 600 - Fairlane 1961/70

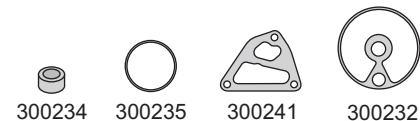
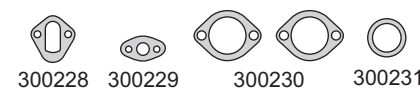
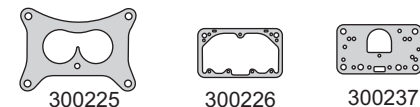
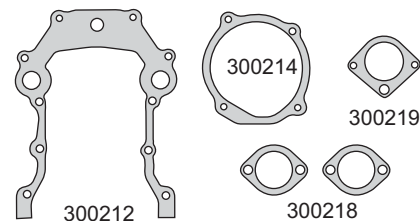
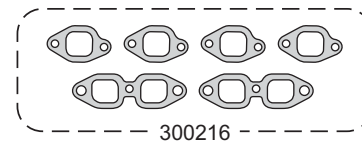
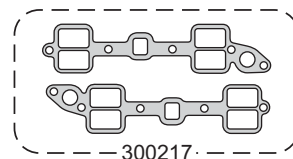
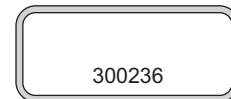
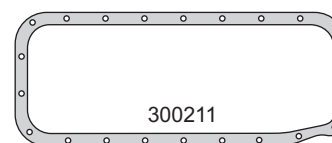
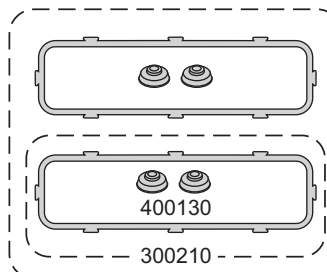
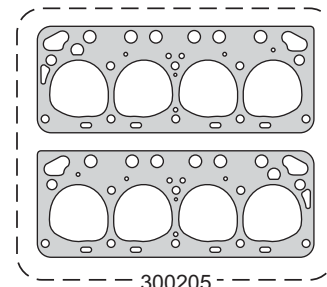
272 - V8 FI
292 - V8 FI4458
4785170
17092
95.25

Nº OE	Descripción/Description	Mat.	Ref.
	Jgo. de juntas para motor		● 300200-R
	Jgo. junta tapa cilindros Ø 97 ± 1.40 (2)		NFT 1 300205
COAE6584B	Conj. junta tapa válvulas superior (3)		CG 2 300210
COAE6710B	Junta para cárter		CG 1 300211
B4A6020A	Tapa distribución		NB 1 300212
B5A8507A	Tapa bomba de agua		NB 1 300214
BA7A9433	Jgo. múltiple escape (6)		NFT 1 300216
	Jgo. múltiple admisión (2)		NFT 1 300217
BA5A9450A	Salida de escape		FCH 2 300218
B5A8255A	Base termostato		CB 1 300219
	Jgo. juntas carburador HOLLEY ARGELITE		VS 300220
	Base carburador		NB 1 300225
	Cuba HOLLEY abierta		CG 300226
C3AZ9417C	Base bomba nafta		NB 1 300228
EAN8563B	Brida salida agua		NB 1 300229
B5A9450A	Acople múltiple escape		FCH 2 300230
	Arandela tapa válvulas		GS 4 400130
	Vaso combustible		CG 1 300231
EAA6838A	Base filtro aceite		CG 1 300232
B9A6570A	Arandela tapa válvulas		GS 300233
B4A6698A	Buje bomba aceite		GS 1 300234
B6Q6619A	Tapa bomba aceite		GS 1 300235
COAE6521A	Tapa lateral botadores		CG 1 300236
	Placa HOLLEY cerrada		CG 300237
	Intermedia carburador HOLLEY		NB 300238
B6Q6659A	Base bomba aceite		NB 1 300241
	Jgo. juntas caja velocidades Ford 62/63		VS 300250
	Jgo. juntas caja velocidades F350/600		VS 300251
	Jgo. juntas diferencial EATON 132 A y B		VS 300255
	Núcleo diferencial EATON 132		CB 350355
	Palier		CB 300256
	Palier F700/6000		NB 300557
C90Z6701A	Jgo. juntas empaquetadura bancada (2)		SNA 1 300258
	Palier DANA 60-350		300559
COAE6710B	Junta para cárter		CG 300260
COAE6584B	Tapa válvulas superior		CG 300261
	Tapa diferencial SPICER 70		CG 300264
	Tapa diferencial SPICER 70		NH 300265
	Tapa diferencial EATON 161/162		CG 350369
	Núcleo diferencial EATON 161/162 N		CB 350382
	Tapa diferencial EATON 132 A y B		CG 350388
	Kit de retenes completo		R300200
	Jgo. retén válvulas (16)		P 1 R300210P
	Retén distribución 47.65 x 65.05 x 11.83		P 1 R300212P

FORD



Motor/Engine Cm³ HP Ø

OHC 1990 63 89.32

Ford: Taunus L - GXL - Ghia 1974/...



Nº OE	Descripción/Description	Mat.		Ref.
	Jgo. de juntas para motor			300300-R
	Jgo. de juntas superior			300395
76BH6051B	Junta tapa cilindros Ø 91.1 ± 1.40	NFT	1 1	300305
	Jgo. de tornillos para tapa de cilindros			B300300
74BR6584AE	Junta tapa válvulas	CG	1 1	300310
	Jgo. junta para cárter (4)	CG	1	300311
74BR6020A	Tapa distribución	NB	1	300312
74BR8507A	Bomba de agua	NB	1	300314
78BR9448A	Múltiple escape	NFT	1 1	300316
74BR9439A	Múltiple admisión	NB	1 1	300317
74BR8255A	Salida agua termostato	CB	1 1	300319
BAD3DZ9502	Jgo. juntas carburador GALILEO	VS		300320
	Base carburador	NB	1 1	300325
74BR6625A	Bomba aceite a block	NB	1	300327
74BR9417A	Base bomba nafta	CB	1	200028
	Tubo llenado aceite	NB	1	300329
	Jgo. juntas caja velocidades	VS		300350
	Tapa diferencial TRANSAX	CG		450355
	Palier	CB		300356
	Jgo. juntas para cárter	CGT		300360
	Junta tapa válvulas	CGT		300361
	Kit de retenes completo			R300300
	Jgo. retén válvulas (8)	P	1	R300310P
	Retén bancada 92 x 108 x 9.8	P	1	R300311P
	Retén reforma bancada 91.5 x 106.5 x 5.5	P	1	R300411P
	Retén distribución 43.41 x 56.02 x 9.3	P	3	R300312P

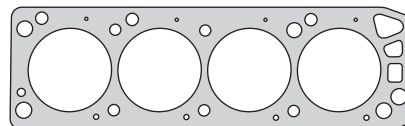

300305

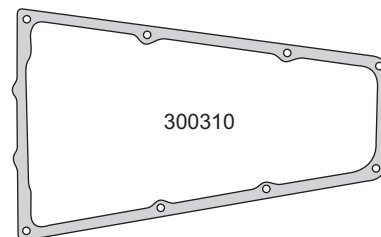

300310

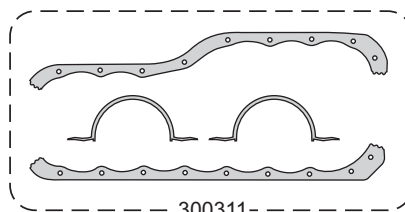

300311



300316



300317

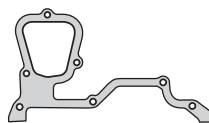

300312

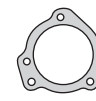

300314



300319



300325



300327



200028



300329



R300311P



R300411P



R300312P



R300310P

FORD

FORD



Motor/Engine	Cm³	HP	Ø
OHC	2299	100/114	96

Ford: Taunus - Sierra - XR4 - Falcon 1974/...
GXL/GT - SP/Ghia
Maverick 1975/79 - Mustang 1980/...



Nº OE	Descripción/Description	Mat.	Ref.
	Jgo. de juntas para motor		300400-R
	Jgo. de juntas superior		300495
76BR6051A	Junta tapa cilindros Ø 98 ± 1.40	NFT 1 1	300405
	Jgo. de tornillos para tapa de cilindros		B300300
74BR6584CE	Junta tapa válvulas	CG 1 1	300310
	Jgo. junta para cárter (4)	CG 1 1	300311
74BR6020A	Tapa distribución	NB 1 1	300312
74BR8507A	Bomba de agua	NB 1 1	300314
78BR9448A	Múltiple escape	NFT 1 1	300316
74BR9439A	Múltiple admisión	NB 1 1	300317
	Múltiple admisión sierra	NB 1 1	300417
	Salida de escape SP	FCH 1 1	300418
74BR8255A	Salida agua termostato	CB 1 1	300319
74BR9502A	Jgo. juntas carb. SOLEX 34 eies 74 BR-9502A	VS	300420
75BR9502A	Jgo. juntas carb. SOLEX 34 eies 82 BR-9502A	VS	300421
82BR9502A	Jgo. juntas carb. SOLEX 34eies Arg 82 BR-9502A	VS	300422
84BR9502A	Jgo. juntas carb. SOLEX 34 TEIE 84 BR-9502A	VS	300423
74BR9447A	Base carburador	NB 2 2	300425
74BR6625A	Bomba aceite a block	NB 1	300327
74BR9417A	Base bomba nafta	CB 1	200028
	Tubo llenado aceite	NB 1	300329
	Jgo. juntas caja velocidades 4ta.	VS	300350
	Jgo. juntas caja velocidades 5ta.	VS	300450
	Tapa diferencial TRANSAX	CG	450355
	Jgo. junta para cárter	CG	300360
74BR6584CE	Junta tapa válvulas	CG	300361
	Junta tapa cilindros competición (0.60)	NFT	300490-0.60
	Junta tapa cilindros competición (1.00)	NFT	300490-1.00
	Kit de retenes completo		R300400
	Jgo. retén válvulas (8)	P 1	R300410P
	Reten bancada 92 x 108 x 9.8	P 1	R300311P
	Retén reforma bancada 91.5 x 106.5 x 5.5	P 1	R300411P
	Retén distribución 43.41 x 56.02 x 9.3	P 3	R300312P

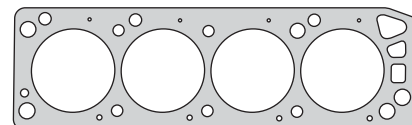

300405

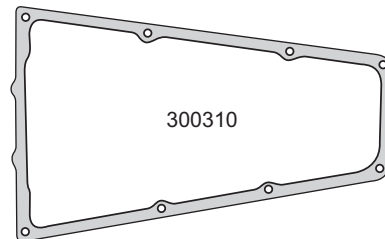

300310

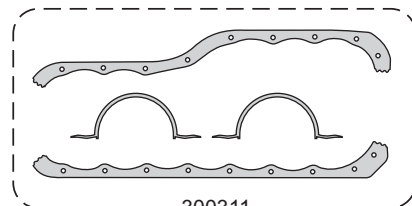

300311



300316

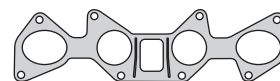

300317

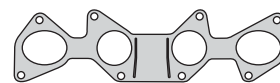

300417

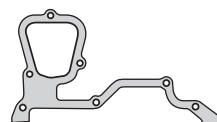

300312

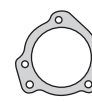

300314



300418



300319



300327



200028

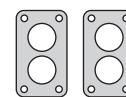

300425



300329



R300311P



R300411P



R300312P



R300410P

FORD

FORD



Motor/Engine	Cm³	HP	Ø
V8 FII	4785	180	95.25

Ford: F100 - 350 - 600 - Fairlane 1/8 - LTD 500
Fase II 1969/76



Nº OE	Descripción/Description	Mat.	Ref.
	Jgo. de juntas para motor		300500-R
BAD0AZ6051A/B	Jgo. junta tapa cilindros Ø 98 ±1.40 (2)	NFT	1 300505
COAE6584B	Conj. junta tapa válvulas superior (3)	CG	2 300210
COAE6710B	Junta para cárter	CG	1 300211
B4A6020A	Tapa distribución	NB	1 300212
B5A8507A	Tapa bomba de agua	NB	1 300214
BADOTZ9433	Jgo. múltiple escape (2)	NFT	1 300516
BAD0AZ9339	Jgo. múltiple admisión (2)	NFT	1 300517
C6AZ9450D	Salida de escape	FCH	2 300018
B5A8255A	Base termostato	CB	1 300219
	Jgo. carburador HOLLEY ARGELITE	VS	300220
	Jgo. carburador HOLLEY 2300 BA-D2/3 9510-A	VS	300520
BADCOZ9447A	Base carburador	NB	1 300225
	Cuba HOLLEY abierta	CG	300226
C3AZ9417C	Base bomba nafta	NB	1 300228
EAN8563B	Brida salida agua	NB	1 300229
B5A9450A	Palier DANA 60 f-350 (al)	FCH	2 300230
	Acople múltiple escape	CG	1 300231
EAA6838A	Base filtro aceite	CG	1 300232
B9A6570A	Arandela tapa válvulas	GS	4 300233
B4A6698A	Buje bomba aceite	GS	1 300234
B6O6619A	Tapa bomba aceite	GS	1 300235
COAE6521A	Tapa lateral botadores	CG	1 300236
	Placa HOLLEY cerrada	CG	300237
	Intermedia carburador HOLLEY	NB	300238
B6O6659A	Base bomba aceite	NB	1 300241
BAC90Z6A636A	Acople filtro aceite	CG	1 300542
	Jgo. juntas caja velocidades 3.03 1ra. Serie	VS	300051
	Jgo. juntas caja velocidades TRANSAX	VS	300052
	Palier DANA 60 f-350	CB	300556
C90Z6701A	Jgo. juntas empaquetadura bancada (2)	SNA	1 300258
	Vaso nafta		300559
	Tapa diferencial SPICER 70	CG	300264
	Kit de retenes completo		R300200
	Jgo. retén válvulas (16)	P	1 R300210P
	Retén distribución 47.65 x 65.05 x 11.83	P	1 R300212P

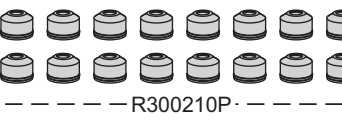
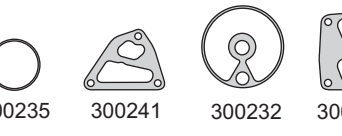
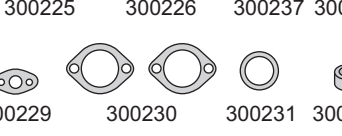
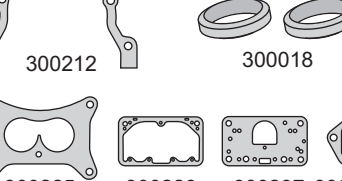
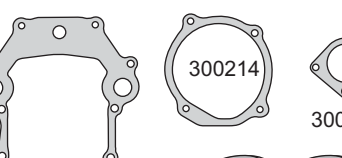
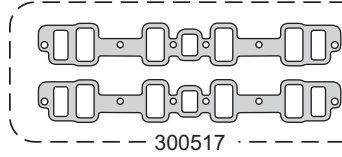
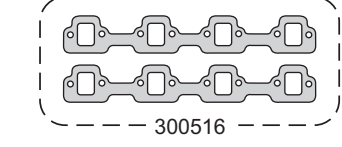
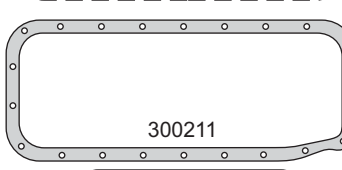
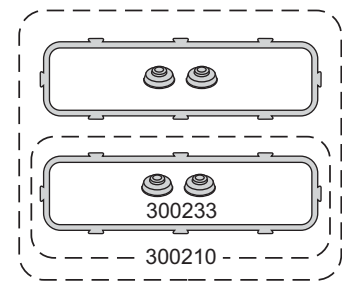
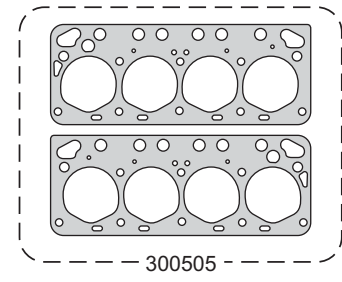

FORD

FORD



Motor/Engine	Cm³	HP	Ø
OHC	1597	75	81.3

Ford: Sierra 1.6L 1984/...



Nº OE	Descripción/Description	Mat.	Ref.
	Jgo. de juntas para motor		300600-R
	Jgo. de juntas superior		300695
84HM6051AC	Junta tapa cilindros Ø 83.5 ± 1.40	NFT	1 1 300605
	Jgo. de tornillos JTC (HAT55055/HAT55100)		B300600
83HM6584AA	Junta tapa válvulas	CG	1 1 300610
	Jgo. junta para cárter (4)	CG	1 1 300611
72HM6020AA	Tapa distribución	NB	1 1 300612
70HM8507AA	Bomba de agua	NB	1 1 300614
	Múltiple escape	NFT	1 1 300616
71HM9441AB	Múltiple admisión	NB	1 1 300617
81AB9451DA	Salida de escape	FCH	1 1 300618
70HM8255AB	Termostato	CB	1 1 300619
L84HF9447AA	Jgo. juntas carburador weber 84F-9502-AA	VS	300620
84HF9447AA	Base carburador	NB	2 2 300625
815M9417CIA	Base bomba nafta S/AA	NB	1 300628
71HM6659AB	Tubo aspiración bomba aceite	NB	300629
	Brida caño calefactor	NB	1 250430
85BR9417A	Base bomba nafta C/AA	NB	1 300630
	Jgo. juntas caja velocidades 5ta.	VS	300450
	Jgo. juntas carburador weber BR	VS	300621
	Tapa diferencial	NB	300659
	Jgo. junta para cárter	CGT	300660
	Kit de retenes completo		R300600
	Jgo. retén válvulas (8)	P	1 R300610P
	Retén bancada 79.38 x 95.25 x 11.11	P	1 R300611P
	Retén distribución árbol levas 42 x 56 x 7	P	3 R300612P

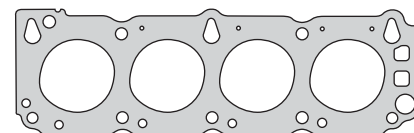

300605

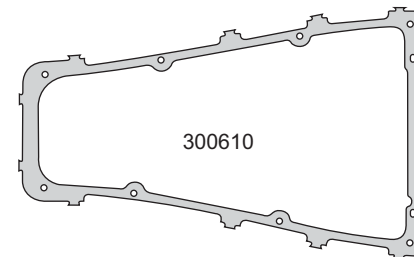

300610

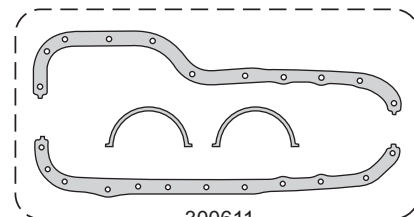

300611

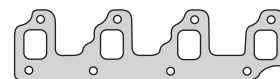

300616

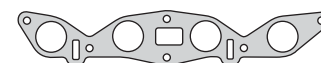

300617

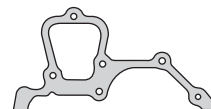

300612



300614



300618



300619

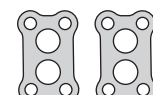

300625



300628



300629



250430



300630



R300611P

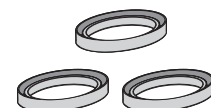

R300612P



R300610P

FORD

FORD



Motor/Engine	Cm³	HP	Ø
CHT/AE	1555	73	77

Ford: Escort - Saveiro - Gol - Corcel II
Del Rey - Scala - Pampa 1983/...
Belina - Verona 1989/...

Volkswagen: Saveiro - Voyage - Logus 1989/...



Nº OE	Descripción/Description	Mat.	Ref.
	Jgo. de juntas para motor		300700-R
	Jgo. de juntas superior		300795
84AU-6051R	Junta tapa cilindros Ø 78 ± 1.40	NFT 1 1	300705
84AU-6051B	Junta tapa cilindros Ø 78 ± 1.40 N.R. HAS17038	NFT	300707
	Jgo. tornillos tapa cilindros (HAS17038)		B300700
64293	Conj. junta tapa válvulas (4)	N 1 1	300710
	Jgo. junta para cárter (4)	GS 1	300711
73MU-6020A	Tapa distribución	NB 1	300712
	Tapa bomba de agua	NB 1	300714
	Tapa bomba de agua	NB 1 1	560214
84AU-9448C	Múltiple admisión y escape	NFT 1 1	300716
	Entre múltiple	NFT 1 1	300717
	Salida de escape	FCH 1 1	220418
	Salida de escape	NFT	230218
85AU-9451A	Salida de escape	FCH 1 1	300718
86AU-8507AA	Base bomba de agua	NB 1 1	300719
	Jgo. juntas carburador	VS	300720
	Base carburador	NB 2 2	300725
	Tapa y toma bomba aceite	NB 1	550427
78MU-6659A	Bomba aceite	CB 1	300727
75MU-9417A	Base bomba nafta	NB 2	300728
84AU-6W021A	Placa tapa cilindros	NB 1 1	300729
E0FZ-6734AA	Tapón cárter A 15 x 21 x 2A	AL 1	300730
	Base bomba agua	NB 1 1	300731
86AU-8255AA	Termostato	NB 1 1	300733
	Arandela base distribuidor	NB 1	550338
	Unión caño escape	AC	300740
	O'ring tapa cilindros a calefactor G 36 x 3	GS 1 1	260142
	Arandela tapa válvulas	GS 3 3	300742
	Jgo. juntas caja velocidades	VS	300750
	Jgo. junta para cárter	CGT	300760
78MU-6055A	Jgo. supl. camisa cilindros superior (0.095) (4)	CU 1	300770-0.095
78MU-6055B	Jgo. supl. camisa cilindros superior (0.115) (4)	CU	300770-0.115
78MU-6055C	Jgo. supl. camisa cilindros superior (0.135) (4)	CU	300770-0.125
78MU-6055D	Jgo. supl. camisa cilindros superior (0.155) (4)	CU	300770-0.155
	Kit de retenes completo		R300700
	Jgo. retén válvulas (8)	V 1	R310810V
	Retén bancada 82 x 105 x 12	P 1	R300711P
	Retén árbol de levas 35 x 50 x 7	P 1	R470013P

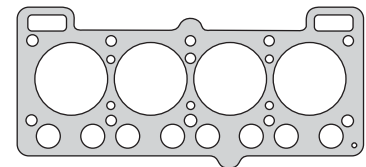

300705

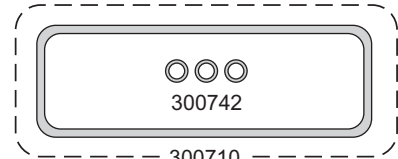

300742

300710

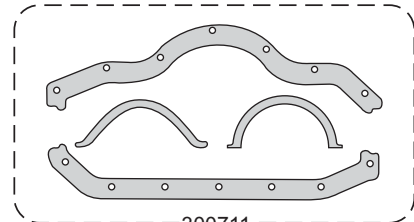

300711

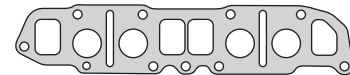

300716

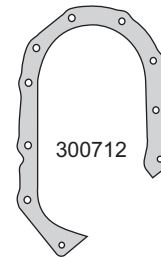

300712

300714

560214

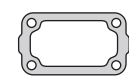

300717



230218

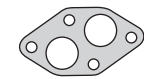

300718

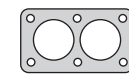

220418

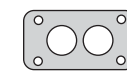

300725

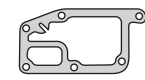
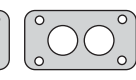

300719



550427



300728

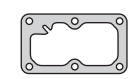

300729



300727

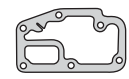

300731



300733



300730



550338



260142



300770-0.095



R4700013P



R300711P

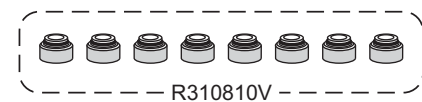

R310810V

FORD

FORD



Motor/Engine

Cm³

HP

Ø

2100

24

98.4

Ford: A - AA 1928/31



Nº OE	Descripción/Description	Mat.	Ref.
	Jgo. de juntas para motor		300800
A 6051 A	Junta tapa cilindros Ø 100.5 ± 1.65	FCH	1 300805
A 6521	Junta tapa válvulas lateral	NB	1 300810
A 6781	Jgo. junta para cárter (5)	CG	1 300811
B 6020	Tapa distribución	NB	1 300812
B 6018	Lateral distribución	NB	1 300813
A 8507	Tapa bomba de agua	NB	1 300814
A 18511	Jgo. múltiple admisión y escape (2)	NFT	1 300816
B 8280	Entrada agua	NB	1 300819
B 9447	Base carburador	NB	1 300825
A 6619 R	Tapa bomba aceite	NB	1 300827
	Cubre volante	NB	1 300829
A 8255	Salida agua	NB	1 300830
A 6648	Caño bomba aceite	NB	2 300831
A 9174	Vaso bomba nafta	CG	1 300832
B 6396	Tapa cruceta	NB	2 300833
	Porta piñón diferencial	NB	1 300835
B 6700	Empaquetadura cárter delantero	SNA	300880

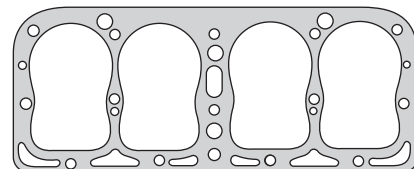

300805

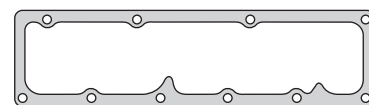

300810

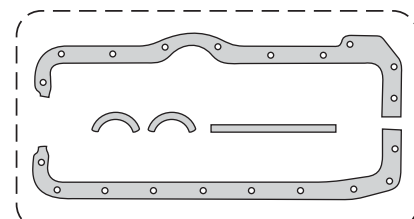

300811

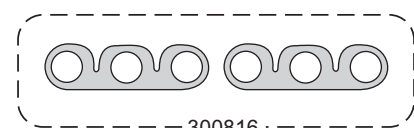

300816



300812



300813



300814



300819



300825



300827



300829



300830



300831



300832

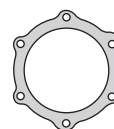

300833

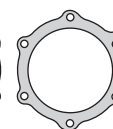

300833

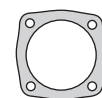

300835

FORD

FORD



Motor/Engine	Cm³	HP	Ø
170 4B	2780	84	88.9
187 4B	3052	96	90.42

Ford: Falcon 4B - STD - De Luxe - Futura Rural 1962/68



Nº OE	Descripción/Description	Mat.	Ref.
	Jgo. de juntas para motor		300900-R
BAC4DZ6051	Junta tapa cilindros Ø 94 ± 1.40	NFT	1 300905
	Jgo. de tornillos para tapa de cilindros		B300000
CODE6584B	Junta tapa válvulas superior	CG	1 300010
BAC9DZ6781A	Jgo. junta para cárter (4)	CG	1 300011
BAC9DZ6020A	Tapa distribución	NB	1 300012
CODE8507A	Bomba de agua	NB	1 300014
BAC8DZ9448A	Múltiple admisión y escape	FCH	1 300015
BAC8DZ9448A	Múltiple admisión y escape	NFT	300016
C6AZ9450D	Salida de escape	FCH	1 300918
CODE8255A	Salida agua termostato	CB	1 300019
BAC9AZ9502A	Jgo. juntas carburador HOLLEY	VS	300020
BAD3DZ9502A	Jgo. juntas carburador GALILEO	VS	300021
BAC4DZ9447A	Base carburador	NB	1 300025
BAC9DZ9447B	Base carburador	NB	1 300125
	Tapa cuba HOLLEY	CG	300026
	Bomba aceite	NB	1 300027
C3AZ9417C	Bomba nafta	NB	1 300028
BAC9DZ9447A	Base precalentador	NB	1 300031
CODE6626A	Cañería aceite	NB	1 300032
	Intermedio HOLLEY 188/221	NH	300033
	Válvula potencia	CB	300034
	Jgo. juntas caja velocidades FAE	VS	300050
C90Z6701A	Jgo. juntas caja velocidades importado	VS	300950
C90Z6701A	Jgo. juntas empaquetadura bancada (2)	SNA	1 300058
BAC9DZ6781A	Jgo. juntas para cárter	CG	300060
CODE6584B	Tapa válvulas superior	CG	300061
	Kit de retenes completo		R300900
	Jgo. retén válvulas (12)	P	1 R300010P
	Jgo. retén válvulas capuchones (12)	P	R300010-1P
	Retén bancada 85.7 x 100 x 5.5	P	1 R300911P
	Retén distribución 44.45 x 60.3 x 11.1	P	1 R300012P

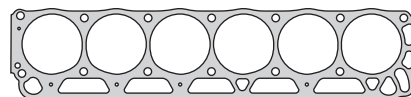

300905

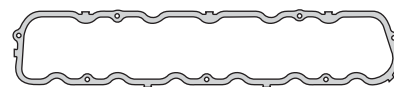

300010

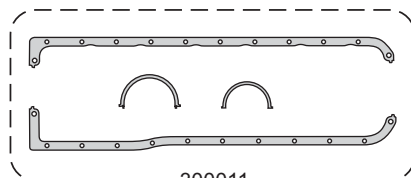

300011

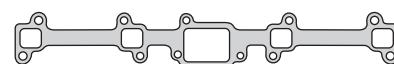

300015

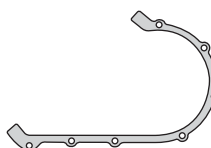

300012



300014



300918



300019



300025



300125



300026



300027



300028



300031



300032



300033



300058



R300012P



R300911P

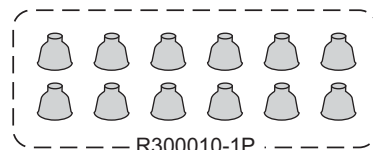

R300010-1P

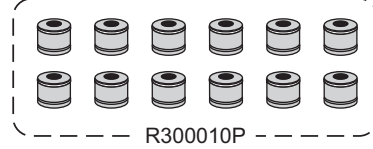

R300010P

FORD

FORD



Motor/Engine	Cm³	HP	Ø
HL14G/CFI/EFI	1392	73/75	77.2

Ford: Escort 1986/98 - Orion 1986/94



Nº OE	Descripción/Description	Mat.	Ref.
	Jgo. de juntas superior		301095-R
	Junta tapas cilindros Ø 80 \pm 1.70	NFT	1 301007
	Jgo. tornillos tapa cilindros (HAS13038)		B301000
	Junta tapa válvulas	CG	1 301010
	Múltiple escape	NFT	1 301016
	Múltiple admisión	NB	1 301017
	Aislante base bomba nafta	NB	1 301028
	Junta motor	NB	1 301040
	O'ring G 40.94 x 2.62	GS	1
	O'ring G 46.5 x 38.5 x 4	GS	1
	Jgo. retén válvulas (8)	V	1 R301010V
	Retén árbol de levas y distribución 42 x 56 x 7	V	1 R300612V

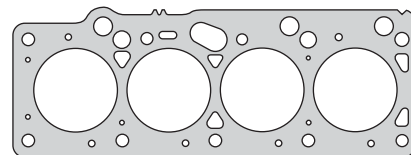

301007

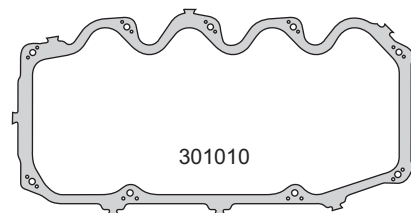

301010



301016

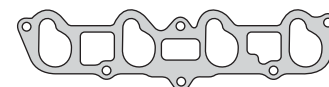

301017



301028



301040



G 40.94 x 2.62



G 46.5 x 38.5 x 4



R300612V



R301010V

FORD

FORD



Motor/Engine	Cm³	HP	Ø
CHV(HL16CFI)	1597	90	80
CVH(H16G/MFI)	1597	79	80
CVH(HL16H/I)	1597	79/105	80
CVH(HL16G/H)	1597	79/96	80

Ford: Fiesta i - Orion i 1989/92
 Escort - Escort XR3 1980/85
 Fiesta XR2 1984/85
 Escort - Orion - Escort XR3i 1985/90



Nº OE	Descripción/Description	Mat.	Ref.
	Jgo. de juntas para motor		301100-R
	Jgo. de juntas superior	●	301195
	Jta. tapa cilindros Ø 83 \pm 1.70 N.R.	NFT 1 1	301107
	Jgo. tornillos tapa cilindros (HAS13038)		B301000
	Junta tapa válvulas	CG 1 1	301010
	Jgo. junta para cárter (4)	CG 1 1	301111
	Tapa distribución	NB 1 1	301112
	Base distribución	NB 1 1	301113
	Múltiple escape	NFT 1 1	301116
	Múltiple admisión	NB 1 1	301017
	Múltiple admisión	NB 1 1	301117
	Junta aislante base bomba de agua	NB 1 1	301028
	Junta	NB 1 1	301130
	Múltiple admisión	NB 1 1	301131
	Junta	NB 1 1	301132
	Junta	NB 1 1	301133
	Junta	NB 1 1	301134
	Junta	NB 1 1	301135
	Junta	CB 1 1	320235
	Entrada aire	CB 1 1	340837
	Junta	NB 1 1	301137
	EGR válvula	NFT 1 1	320739
	Junta	NB 1 1	301040
	Arandela A 12 x 15 x 1.2 A	AL 1 1	
	Anillo G 35 x 28 x 1.6	GS 1 1	
	Anillo G 68 x 76 x 4	GS 1 1	
	O´ring G 31.3 x 2.62	GS 1 1	
	O´ring G 40.94 x 2.62	GS 1 1	
	Anillo G 46.5 x 38.5 x 4	GS 1 1	
	Kit de retenes completo		R301100
	Jgo. retén válvulas (8)	P 1 1	R301110P
	Retén bancada 88 x 108 x 10	P 1 1	R320311P
	Retén distribución 43.41 x 56.02 x 9.3	P 1 1	R300312P
	Retén árbol de levas 35 x 50 x 7	P 1 1	R470013P

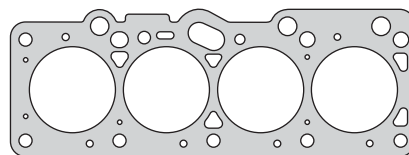

301107

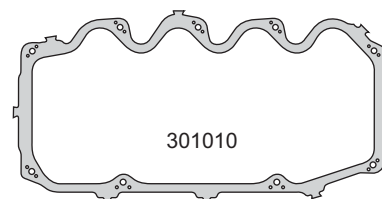

301010

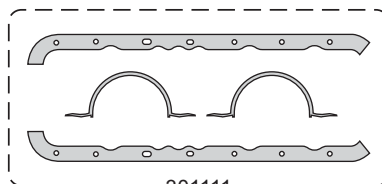

301111



301116



301017



301117



301131

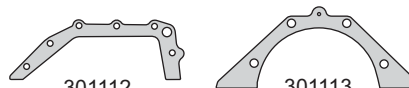

301112

301113



301028

301134

301135

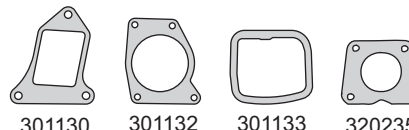

301130

301132

301133

320235

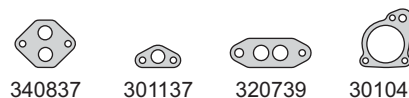

340837

301137

320739

301040

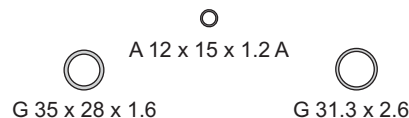

A 12 x 15 x 1.2 A

G 35 x 28 x 1.6

G 31.3 x 2.62

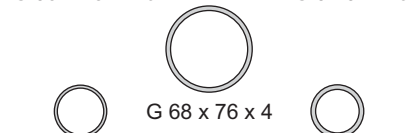

G 68 x 76 x 4

G 40.94 x 2.62

G 46.5 x 38.5 x 4



R320311P

R300312P

R470013P



R301110P

FORD

FORD



Motor/Engine Cm³ HP Ø

ZETEC 16V 1597 90 76

Ford: Mondeo 1993/...



Nº OE	Descripción/Description	Mat.			Ref.
	Jgo. de juntas para motor				301200-R
	Jgo. de juntas superior		●	●	301295
	Jta. tapa cilindros Ø 77.5 ±1.60 N.R.	NFT	1	1	301207
	Jgo. de tornillos JTC (HAT55055/HAT55100)				B320300
1663394	Conj. junta tapa válvulas (11)	S	1	1	320310
7008824	Junta para cárter	N		1	320311
7378788	Frente bomba aceite	CB		1	320312
6691888	Bomba de agua	CB		1	320314
	Múltiple escape	NFT	1		320315
7181761	Múltiple escape	NFT		1	320316
	Múltiple admisión	AL/N	1	1	321517
1663383	Múltiple admisión	CB		1	320329
	Junta caja termostato	CB		1	320332
	Junta	SLS	1		340833
1663908	Chupador aceite	CB		1	320334
7090340	Mariposa gases	CB		1	320335
1663861	Bancada trasera	CB		1	320336
6759630	Anillo tapa válvulas G 8.5 x 13.4 x 5	GS	10	10	320337
	Arandela cárter A 15 x 21 x 2 A	AL		1	
	Kit de retenes completo				R320300
	Jgo. retén válvulas (16)	V		1	R320310V
	Retén bancada 88 x 108 x 10	V		1	R320311V
	Retén distribución 35 x 50 x 7	V		1	R470013V
	Retén árbol levas 42 x 53 x 7	V		2	R320313V

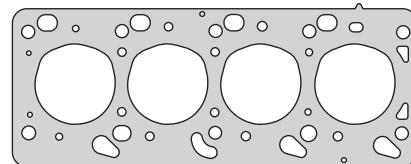

301207

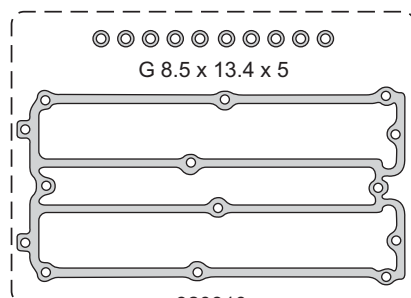

G 8.5 x 13.4 x 5

320310

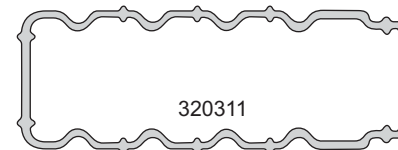

320311



320315/16



321517

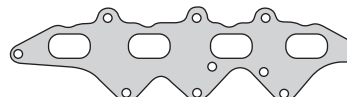

320329



320312



320336



320314



320332



340833



320334



A 15 x 21 x 2 A



320335



R320311V



R470013V



R320313V

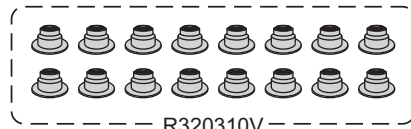

R320310V

FORD



Motor/Engine **ZETEC 16V** Cm³ **1597** HP **90** Ø **76**

Ford: Escort - Orion 1992/...
Fiesta 1994/95



Nº OE	Descripción/Description	Mat.		Ref.
	Jgo. de juntas para motor			301400-R
	Jgo. de juntas superior			301495
	Jta. tapa cilindros Ø 77.5 ± 1.60	NFT	1 1	301207
	Jgo. de tornillos JTC (HAT55055/HAT55100)			B320300
1663394	Conj. junta tapa válvulas (11)	S	1 1	320310
7008824	Junta para cárter	N	1 1	320311
7378788	Frente bomba aceite	CB	1 1	320312
6691888	Bomba de agua	CB	1 1	320314
	Múltiple escape	NFT	1 1	320315
7181761	Múltiple escape	NFT	1 1	320316
6669767	Bakelita aislante admisión	BAK	1 1	320317
1048093	Jgo. múltiple admisión (4) 1997/...	N	1 1	320517
1663383	Múltiple admisión	CB	1 1	320329
	Junta caja termostato	CB	1 1	320332
1663908	Chupador aceite	CB	1 1	320334
7090340	Mariposa gases	CB	1 1	320335
1663861	Bancada trasera	CB	1 1	320336
6759630	Anillo tapa válvulas G 8.5 x 13.4 x 5	GS	10 10	320337
	Arandela cárter A 15 x 21 x 2 A	AL	1 1	
	Kit de retenes completo			R320300
	Jgo. retén válvulas (16)	V	1 1	R320310V
	Retén bancada 88 x 108 x 10	V	1 1	R320311V
	Retén distribución 35 x 50 x 7	V	1 1	R470013V
	Retén árbol levas 42 x 53 x 7	V	2 2	R320313V

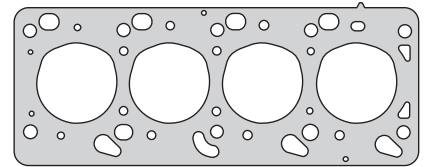

301207

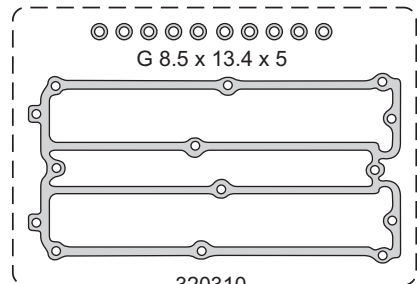

320310

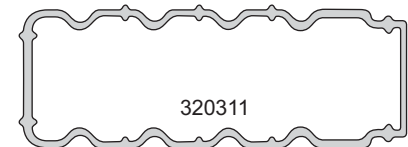

320311



320316

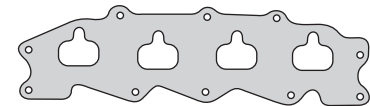

320317



320517

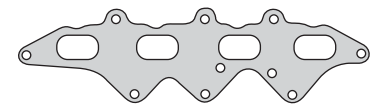

320329

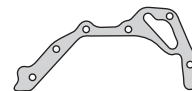

320312



320336



320314

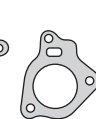

320332



320334

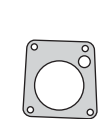

320335

A 15 x 21 x 2A



R320311V



R470013V



R320313V

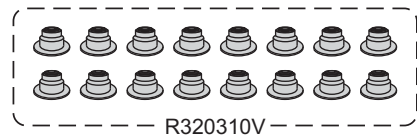

R320310V

FORD



Motor/Engine	Cm³	HP	Ø
ZETEC E (DOHC) 16V	1796	116	80.6

Ford: Focus 1998/...



Nº OE	Descripción/Description	Mat.	Ref.
	Jgo. de juntas para motor		301500-R
	Junta tapa cilindros Ø 81.7 ± 1.20	NFT	1 301507
7114447	Junta tapa cilindros Ø 81.5 ± 1.20	MLS	301508
	Jgo. tornillos tapa cilin. (HAT55055/HAT55100)		B320300
1663394	Conj. junta tapa válvulas (11)	N	1 301510
1078707	Junta para cárter	N	1 301511
1053902	Múltiple espape	AC	1 301515
1048093	Jgo. múltiple admisión 1997/... (4)	N	1 320517
	Junta sobre cárter	NB	1 301538
6974940	Guarnición base termostato	GS	320339
1092262	Guarnición termostato	GS	1 310940
	Kit de retenes completo		R320300
	Jgo. retén válvulas (16)	V	1 R320310V
	Retén bancada 88 x 108 x 10	V	1 R320311V
	Retén distribución 35 x 50 x 9	V	1 R550412V
	Retén árbol levas 42 x 53 x 7	V	2 R320313V

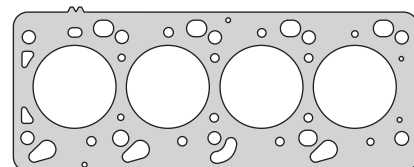

301507

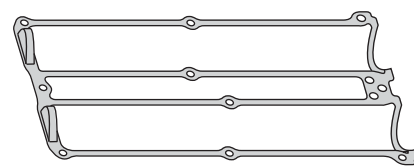

301510

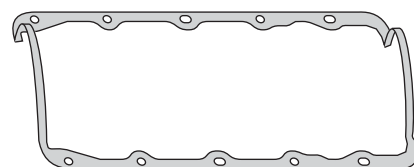

301511

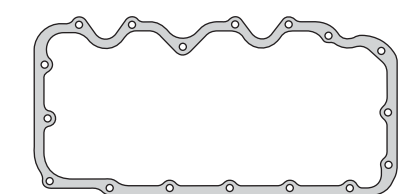

301538



301515

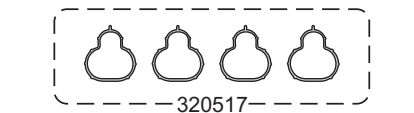

320517



320339



310940



R320311V



R550412V



R320313V



R320310V

FORD

FORD



Motor/Engine	Cm³	HP	Ø
140 F.I	2300		

Ford: Ghia 1991/... - Topaz 1989/94



Nº OE	Descripción/Description	Mat.	Ref.
	Jgo. de juntas para motor		301700-RMX
	Jgo. de juntas superior	●	301795
	Junta tapa de cilindros Ø 96.2 ±1.20	NFT 1 1	301705
	Junta tapa válvulas	CG 1 1	301710
	Junta para cárter	CG 1 1	301711
	Tapa distribución	NB 1 1	301812
	Jgo. múltiple escape (4)	NFT 1 1	301715
	Múltiple admisión	NFT 1 1	301717
	Junta carburador	CB 1 1	200028
	Junta	NB 1 1	301830
	Junta	NB 1 1	301831
	Junta	NB 1 1	301832
	Junta	NB 1 1	301733
	Junta	NB 1 1	301833
	Junta	NB 1 1	301834
	Arandela A 14 x 20 x 1.5 A	AL 1 1	
	Anillo G 10 x 16 x 2	GS 18 18	
	Arandela A 10 x 14 x 1.5 A	AL 10 10	
	Kit de retenes completo		R301800
	Jgo. retén válvulas (8)	P 1 1	R301810P
	Retén bancada 88 x 108 x 10	V 1 1	R320311V
	Retén distribución 45 x 63.8/77 x 10.8	S 1 1	R301712S

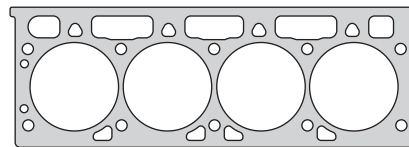

301705

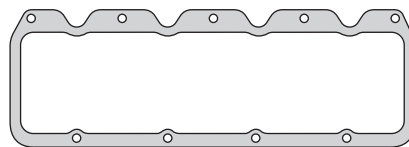

301710

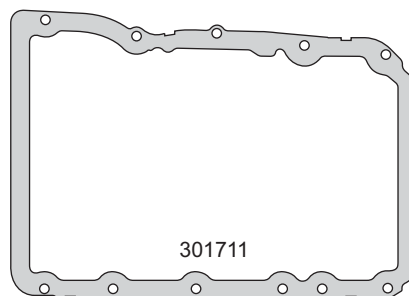

301711

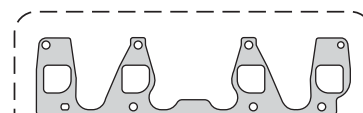

301717

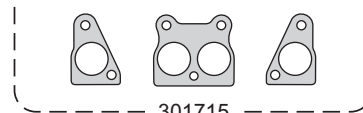

301715



301733

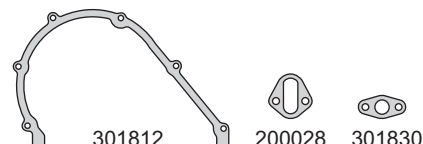

301812

200028

301830

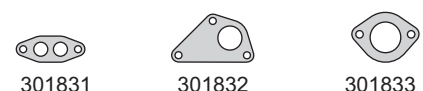

301831

301832

301833



301834

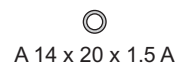

A 14 x 20 x 1.5 A



A 10 x 14 x 1.5 A



G 10 x 16 x 2



R320311V



R301712S



R301810P

FORD

FORD



Motor/Engine	Cm³	HP	Ø
140 Carburado	2300		

Ford: Topaz - GS - GLX 1984/88



Nº OE	Descripción/Description	Mat.	Ref.
	Jgo. de juntas para motor		301800-RMX
	Junta de cabeza Ø 96.2 ±1.20	NFT	1 301705
	Junta tapa válvulas	CG	1 301710
	Junta para cárter	CG	1 301811
	Tapa distribución	NB	1 301812
	Junta	CG	1 301813
	Jgo. múltiple escape (4)	NFT	1 301815
	Múltiple admisión y escape	NFT	1 301817
	Junta carburador	CB	1 200028
	Junta	NB	1 301830
	Junta	NB	1 301831
	Junta	NB	1 301832
	Junta	NB	1 301733
	Junta	NB	1 301833
	Junta	NB	1 301834
	Arandela A 14 x 20 x 1.5 A	AL	1
	Arandela A 14 x 18 x 1.5 A	AL	1
	Kit de retenes completo		R301800
	Jgo. retén válvulas (8)	P	1 R301810P
	Retén bancada 88 x 108 x 10	V	1 R320311V
	Retén distribución 45 x 63.8/77 x 10.8	S	1 R301712S

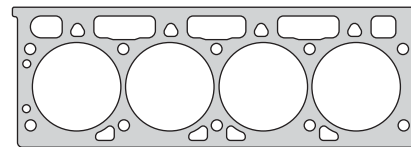

301705

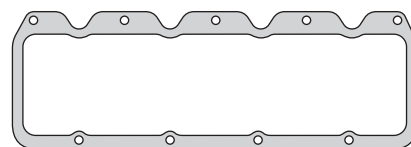

301710

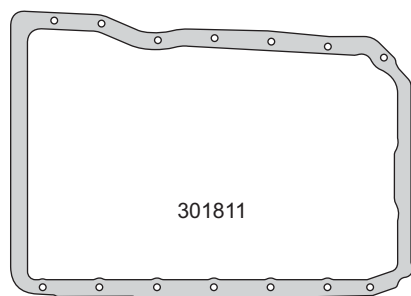

301811

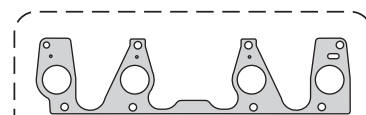

301817

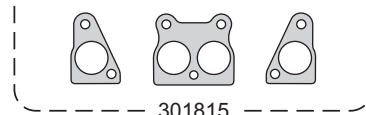

301815



301733

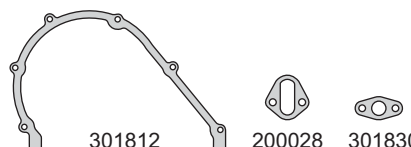

301812

200028

301830



301813

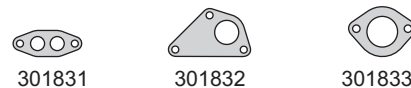

301831

301832

301833



301834



A 14 x 20 x 1.5 A

A 14 x 18 x 1.5 A



R320311V



R301712S



R301810P

FORD



Motor/Engine	Cm ³	HP	Ø
232 V6	3811	130	96.8

Ford: V6 3.8 (USA) Mustang - Taurus - Sable
Thunderbird - Cougar 1985/87



Nº OE	Descripción/Description	Mat.			Ref.
	Jgo. de juntas para motor				301900-RMX
	Jgo. de juntas superior	●			301995
	Jgo. tapa cilin. Ø 99 \pm 1.20 (2)	NFT	1	1	301905
	Jgo. tapa cilin. Ø 99 \pm 1.20 (2)	NFT			301907
	Junta tapa valvulas	CG	2	2	301910
	Jgo. junta para cárter (2)	CG		1	301911
	Junta distribución	CB		1	320212
	Junta distribución	NB		1	320212-2
	Bomba de agua	CB		1	320214
	Bomba de agua	NB		1	320214-1
	Jgo. múltiple escape (2)	NFT	1	1	320215
	Jgo. multiple admisión (4)	NFT	1	1	301917
	Junta carburador	NB	1	1	301921
	Junta	NB		1	301922
	Junta tubo bomba de aceite	CB		1	320227
	Junta base bomba nafta	CB		1	200028
	Junta motor	NB		1	301930
	Sello múltiple admisión lateral	CG	1	1	320231
	Sello múltiple admisión frontal	CG	1	1	320232
	Kit de retenes completo				R320200
	Jgo. retén válvulas (12)	P		1	R320210P
	Retén bancada 92 x 108 x 9.8	P		1	R300311P
	Retén distribución 47 x 65/80 x 15	P		1	R340412P

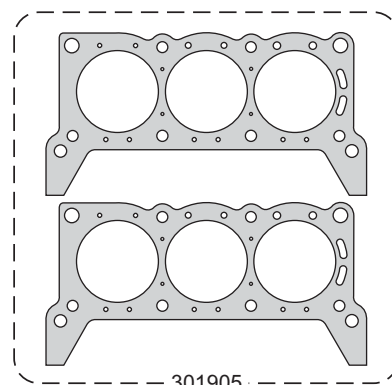

301905

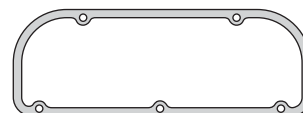

301910

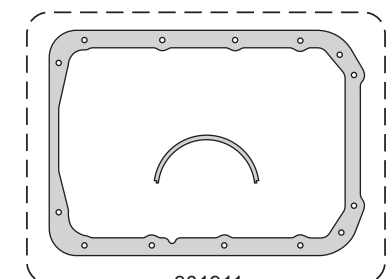

301911

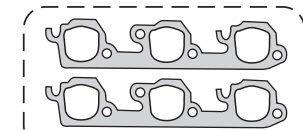

320215

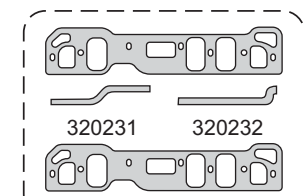

320231

320232

301917

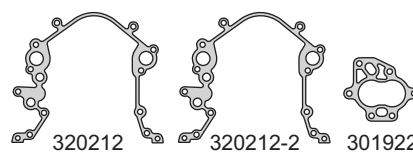

320212

320212-2

301922

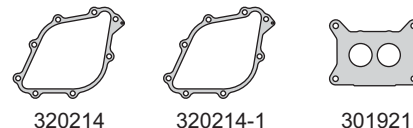

320214

320214-1

301921

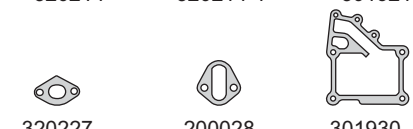

320227

200028

301930



R300311P

R340412P



R320210P

FORD

FORD



Motor/Engine	Cm³	HP	Ø
Duratorq (DOHC) 16V	2402	120/125	89.9

Ford: Transit TD 2000/...

DIESEL



Nº OE	Descripción/Description	Mat.	Ref.
	Jgo. de juntas para motor		302001-R
	Junta tapa cilindros Ø 91 \pm 1.10	NFT	302007-1M
	Junta tapa cilindros Ø 91 \pm 1.15	NFT	302007-2M
	Junta tapa cilindros Ø 91 \pm 1.20	NFT	302007-3M
1096227/1	Junta tapa cilindros Ø 91 \pm 1.10	MLS	302008-1M
	Junta tapa cilindros Ø 91 \pm 1.15	MLS	302008-2M
	Junta tapa cilindros Ø 91 \pm 1.20	MLS	302008-3M
1102674	Jgo. de tornillos para tapa de cilindros		B302000
1099778	Junta tapa válvulas	N	302010
1112953	Jgo. junta para cárter (2)	SLS	302011
	Junta para cárter	NB	303211
110268/1	Frente distribución	NB	302012
1121210	Distribución a block	SLS	302013
1096559	Apolo bomba de agua	SLS	302014
1120402	Múltiple escape	AC	302015
	Jgo. múltiple admisión (9)	N	302017
1098228	Guarnición termostato	N	302019
1721342	Sello filtro de aceite	GS	302027
1094599	Bomba inyectora	SLS	340328
1146959	Bomba vacío	SLS	302029
1105321	Chupador aceite	NB	302020
1111912	Anillo refrigeración gases	SLS	302031
	Anillo admisión	N	302033
1754585	Junta tapa frontal	AL/GS	302034
1322526	Junta	SLS	302036
1794375	Junta bomba vacío	AC/GS	302044
4640315	Arandela sello retén de block A 28 x 39 x 2	AC/GS	
	Kit de retenes completo		R302000
1096253	Jgo. retén válvulas (16)	V	1 R302010V
1117435	Porta retén bancada	V	PR302011V
1201417	Porta retén distribución	V	PR302012V
1139357	Retén árbol de levas 35 x 502 x 7	V	1 R470013V

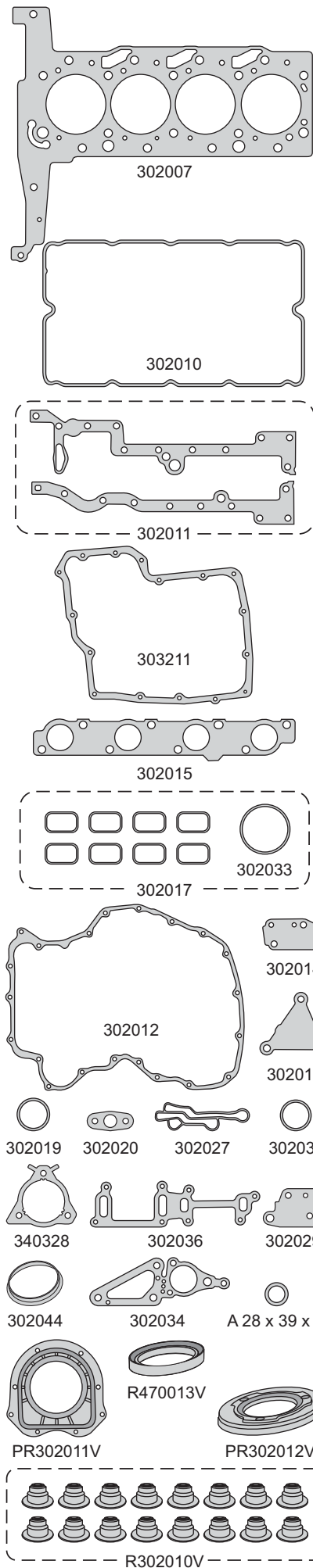

FORD

FORD



Motor/Engine	Cm³	HP	Ø
F6JA - F6JB	1398	68	74
DV4TD (8HX)	1398	70	74
DV4TD (8HZ) (SOHC) 8V	1398	68	74

Citroën: C3 - C2 HDI - Xsara HDI 2002/...
Ford: Fiesta - Eco Sport TD 2003/...
 Duratorq TDCI
Peugeot: 206 TDI - 307 HDI 2001/...



DIESEL

Nº OE	Descripción/Description	Mat.	1	2	Ref.
	Jgo. de juntas para motor				302101-R
	Jgo. de junta superior (MLS)		●		302195-1M MLS
	Jgo. de junta superior (MLS)				302195-2M MLS
	Jgo. de junta superior (MLS)				302195-3M MLS
	Jgo. de junta superior (MLS)				302195-4M MLS
	Jgo. de junta superior (MLS)				302195-5M MLS
	Junta tapa cilindros Ø 76 ≥ 1.20	NFT			302107-1M
	Junta tapa cilindros Ø 76 ≥ 1.30	NFT			302107-2M
	Junta tapa cilindros Ø 76 ≥ 1.40	NFT			302107-3M
	Junta tapa cilindros Ø 76 ≥ 1.45	NFT			302107-4M
	Junta tapa cilindros Ø 76 ≥ 1.50	NFT			302107-5M
1146049	Junta tapa cilindros Ø 75 ≥ 1.25	MLS	1		302108-1M
1146050	Junta tapa cilindros Ø 75 ≥ 1.30	MLS			302108-2M
1146051	Junta tapa cilindros Ø 75 ≥ 1.35	MLS			302108-3M
1146052	Junta tapa cilindros Ø 75 ≥ 1.40	MLS			302108-4M
1146053	Junta tapa cilindros Ø 75 ≥ 1.45	MLS			302108-5M
0204.C5	Jgo. tornillos tapa cilindros				B302100
1148101	Conj. junta tapa válvulas (6)	N	1	1	302110
12232358/1	Junta para cárter	NB		1	302111
1145938/1	Frente motor bomba aceite	NB		1	302112
	Bomba de agua	NB		1	302114
1152194	Múltiple escape	AC	1	1	302115
1148106	Jgo. múltiple admisión G 35 x 6 (4)	N	1	1	302117
2565/9451/AA//	Salida de escape	AC			302118
1145938	Anillo bomba aceite G 18 x 24 x 3	GS		1	302127
1145960	Chupador bomba aceite	P			302129
1145944	Jgo. anillo refrigerador aceite (4)	GS		1	302130
	Guarnición entrada filtro aceite	N		1	302131
	Guarnición salida filtro aceite	N		1	302132
	Junta	N	1	1	581036
1210879	O´ring caja mariposa G 43 x 4	S	1	1	
	O´ring tapa válvulas G 6.5 x 1.5	GS	5	5	
	Kit de retenes completo				R302100
1145937	Jgo. retén válvulas (8)	V		1	R302110V
1142360	Retén bancada 85 x 105 x 8	V		1	R560111V
1145953	Retén árbol de levas 27 x 47 x 7	V		1	R470813V
1142359	Retén distribución 40 x 55 x 7	V		1	R270713V

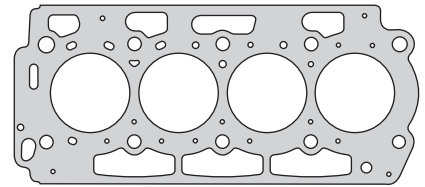

302107

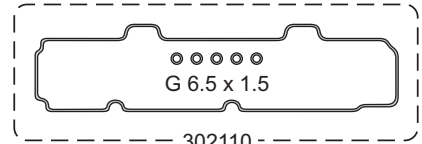

302110

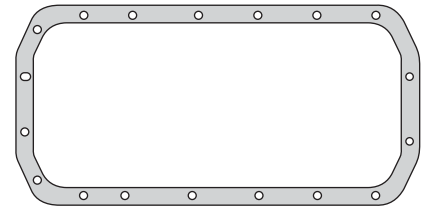

302111



302115



302117

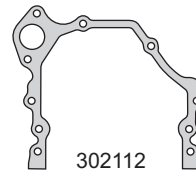

302112

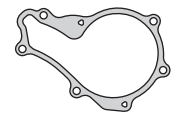

302114

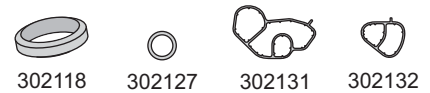

302118

302127

302131

302132



302130



581036



G 43 x 4



R560111V



R270713V



R470813V



R302110V

FORD**taranto**

Motor/Engine	Cm³	HP	Ø
CJBA	1999	145	87.5
Duratec HE/EFI	1999	143/145	87.5
LF	1999	104	87.5
L3 (DOHC) 16V	2261	104	87.5

Ford: Mondeo 2001/... - Eco Sport 2003/... BR
Ranger 2.3 2001/... - Focus - Focus EXE

Mazda: 6 - MPV 2002/...

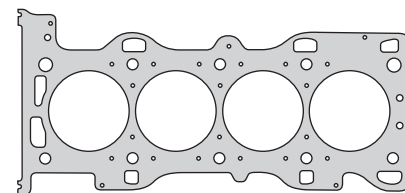

302207

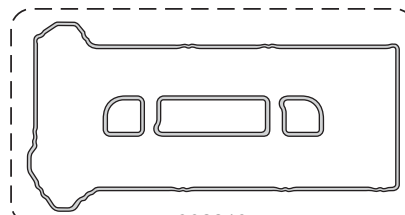

302210

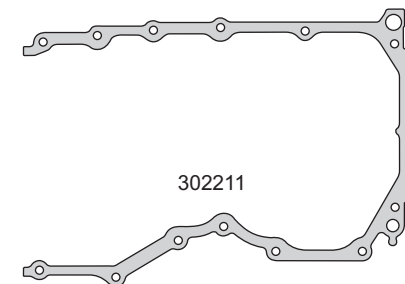

302211

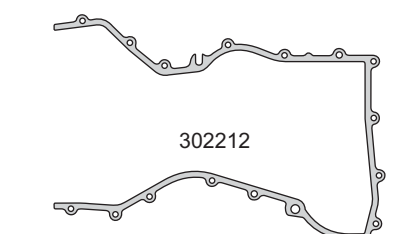

302212



302215

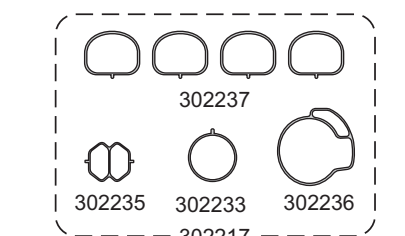

302217

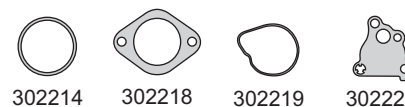

302214

302218

302219

302227

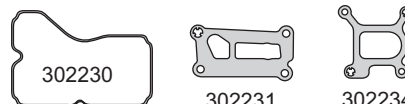

302230

302231

302234



302232

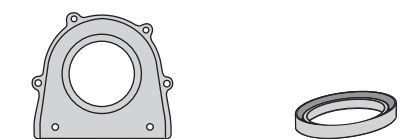

PR302211T

R302212V

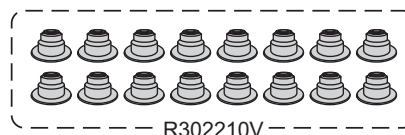

R302210V

Nº OE	Descripción/Description	Mat.	Ref.
	Jgo. de juntas para motor		302200-R
	Jgo. de juntas superior		302295
	Jgo. de juntas superior (MLS)		302295 MLS
	Junta tapa cilindros Ø 89 ± 1.20	NFT	1 1 302207
	Junta tapa cilindros Ø 89 ± 0.40	MLS	1 1 302208
1220025	Jgo. de tornillos JTC (HAT55055/HAT55100)		B302200
1316023/1	Jgo. junta tapa válvulas (4)	N	1 1 302210
1142647/1	Junta para cárter	NB	1 1 302211
1119277	Frente motor	NB	1 1 302212
1S7Z-9448AA	O'ring bomba de agua G 63.09 x 3.53	GS	1 1 302214
	Múltiple escape	AC	1 1 302215
1S71-9451AA	Jgo. múltiple admisión (7)	GS	1 1 302217
1S7Z-8255BC	Salida de escape	AC	1 1 302218
1S7Z-6659AA	Válvula termostática	N	1 1 302219
1S7Z-6B752AA	Base bomba aceite	SLS	1 302227
1S7Z-6840AA	Separador bomba aceite	N	1 302230
1119253	Base filtro aceite	SLS	1 302231
	Chupador bomba aceite	N	1 302232
1119275	Guarnición goma	N	1 1 302233
1S7Z-9F670AA	Conexión salida agua	SLS	1 302234
1S7Z-9E9360A	Válvula reguladora paso a paso	N	1 1 302235
1S7Z-943PAA	Válvula mariposa aceleración	N	1 1 302236
1S7G-6051BG	Junta admisión	N	4 4 302237
	Kit de retenes completo		R302200
1S7Z-6K301AA	Jgo. retén válvulas (16)	V	1 R302210V
1S7Z-6700AA	Porta retén bancada trasera	T	PR302211T
	Retén distribución 37 x 50 x 8	V	1 R302212V

FORD



Motor/Engine Cm³ HP Ø

EFI - NAI4 (SOHC) 8V 2500 117 96

Ford: Pick Up - Ranger 1997/...



Nº OE	Descripción/Description	Mat.	Ref.
	Jgo. de juntas para motor		302300-R
F47E-6051A5A	Junta tapa cilindros Ø 100 ± 1.30 N.R.	NFT	1 340607
	Jgo. de tornillos para tapa de cilindros		B302300
F57Z-6584A	Junta tapa de válvulas	GS	1 340610
F87Z-6710A	Junta para cárter	N	1 340611
F37Z-1448AB	Múltiple escape	NFT	302315
E89E-3439A56	Múltiple admisión	NFT	1 340617
F57Z-9H486C	Entre colectores	NFT	302317
	Termostato	NFT	1 340619
F87Z-8255AA	Anillo termostato G 54 x 3 x 6.5	GS	302319
E57Z-9E936B	Base termostato	NB	302329
	Kit de retenes completo		R302300
	Jgo. retén válvulas (8)	P	1 R340610P
	Retén bancada 79.38 x 95.25 x 11.11	V	1 R300611V
	Retén dist. y árbol de levas 43.41 x 56.02 x 9.3	P	2 R300312P

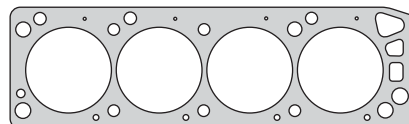

340607

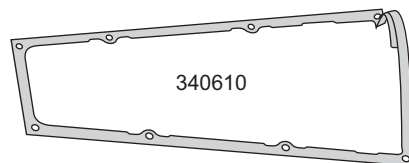

340610

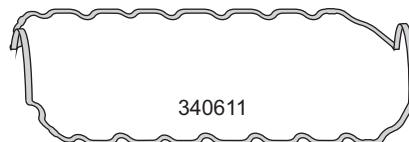

340611



340617



340619



R300611V



R300312P



R340610P

FORD

FORD



Motor/Engine	Cm³	HP	Ø
CJBA	1999	143/145	87.5
Duratec HE/EFI	2261	145/154	87.5
LF (DOHC) 16V	1999	105/141	87.5

Ford: Mondeo 2001/... - Eco Sport 2003/... BR
 Ford Ranger 2001/... BR
 Maverick 2003/... - Focus - Focus EXE
Mazda: 6 2002/... - 3 2003/...

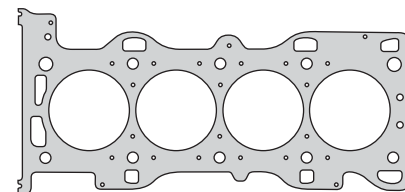

302207

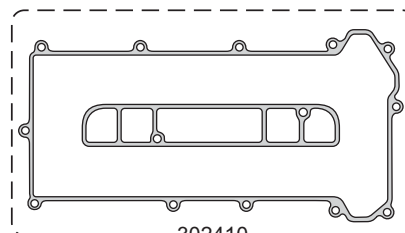

302410

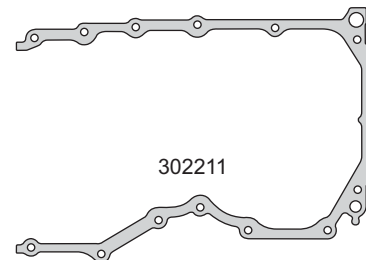

302211

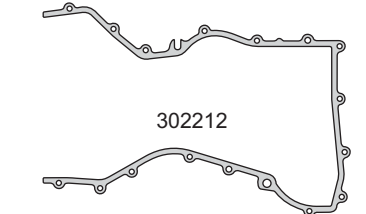

302212



302215

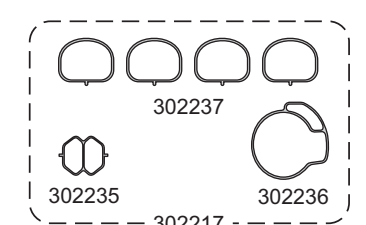

302217

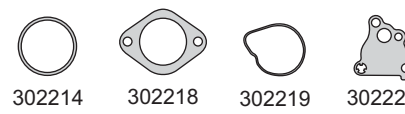

302214 302218 302219 302227

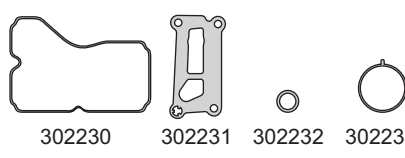

302230 302231 302232 302233



302234

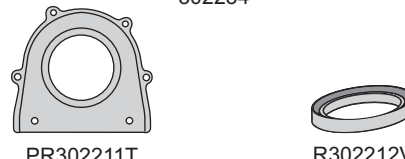

PR302211T R302212V

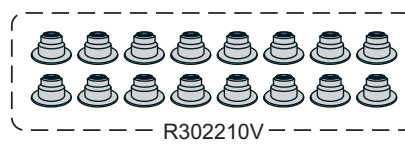

R302210V

Nº OE	Descripción/Description	Mat.	Ref.
	Jgo. de juntas para motor		302400-R
	Jgo. de juntas superior (MLS)		302495 MLS
1S7Z26051AA	Junta tapa cilindros Ø 89 ± 1.20	NFT	1 302207
	Junta tapa cilindros Ø 89 ± 0.40	MLS	1 302208
	Jgo. de tornillos JTC (HAT55055/HAT55100)		B302200
1S7Z6584AA	Conj. junta tapa válvulas (2)	N	1 302410
1316023/1	Junta para cárter	NB	1 302211
1142647/1	Frete motor	NB	1 302212
1119277	O'ring bomba de agua G 63.09 x 3.53	GS	1 302214
1S7Z-9448AA	Múltiple escape	AC	1 302215
	Jgo. múltiple admisión (6)	N	1 302217
1S71-9451AA	Salida de escape	AC	1 302218
1S7Z-8255BC	Válvula termostática	N	1 302219
1S7Z-6659AA	Base bomba aceite	SLS	1 302227
1S7Z-6B752AA	Separador bomba aceite	N	1 302230
1S7Z-6840AA	Base filtro aceite	SLS	1 302231
1119253	Chupador bomba aceite	N	1 302232
	Guarnición goma	N	1 302233
1119275	Conexión salida agua	SLS	1 302234
1S7Z-9F670AA	Válvula reguladora paso a paso	N	1 302235
1S7Z-9E9360A	Válvula mariposa aceleración	N	1 302236
1S7Z-943PAA	Junta admisión	N	4 4 302237
	Kit de retenes completo		R302200
1S7G-6051BG	Jgo. retén válvulas (16)	V	1 R302210V
1S7Z-6K301AA	Porta retén bancada trasera	T	PR302211T
1S7Z-6700AA	Retén distribución 37 x 50 x 8	V	1 R302212V

FORD

FORD



Motor/Engine	Cm³	HP	Ø
Duratec V6 LCBD V6 (DOHC) 24V	2495	170	81.6

Ford: Mystique - Contour 1995/00
Mondeo 1994/00 - Mondeo III 2000/...



Nº OE	Descripción/Description	Mat.	Ref.
	Jgo. de juntas para motor		302500-R
3922601/4028565	Jgo. junta tapa cilin. Ø 84 ± 1.60 (2)	NFT	302507
	Jgo. junta tapa cilin. Ø 83 ± 0.85 (2)	MLS	1 302508
7381330	Junta tapa válvulas izquierda	N	1 302510-I
7381327	Junta tapa válvulas derecha	N	1 302510-D
4139726	Junta para cárter	AC/GS	1 302511
7224827	Junta distribución central	N	1 302512-1
7224828	Junta distribución izquierda	N	1 302512-2
7224826	Junta distribución derecha	N	1 302512-3
6691888	Bomba de agua	CB	1 320314
	Bomba de agua	NB	1 302514
4503102	Jgo. múltiple escape (2)	AC	1 302515
3902545	Jgo. múltiple admisión inferior (2)	PLAST	1 302517-1
3523225	Jgo. múltiple admisión superior (2)	PLAST	1 302517-2
13342711	Junta o´ring termostato G 47.22 x 3.53	GS	1 302531
7318043	Junta válvula mariposa	NFT	1 302532
3699134	Junta abertura bujía	GS	6 302533
	Junta sello	AL/GS	1 302534
3780203	Junta o´ring refrigerador aceite G 66.27 x 3.53	GS	1 302535
7156577	O´ring tubo conector agua G 26.64 x 2.62	GS	6
	Kit de retenes completo		R302500
	Jgo. retén válvulas (24)	V	1 R302510V
F4AZ-6701A	Retén bancada 92 x 108 x 9.8	P	1 R300311P
F3AE-6700A	Retén distribución 47 x 63.4 x 8.8	P	1 R340712P

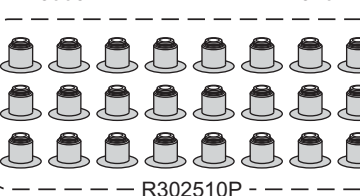
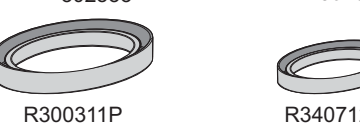
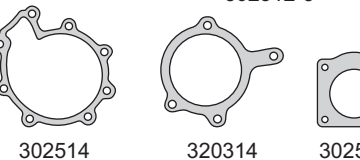
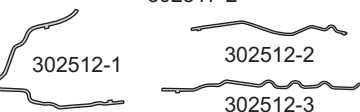
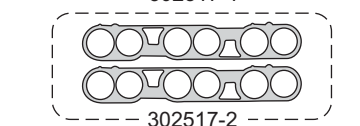
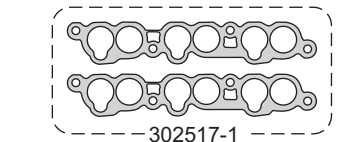
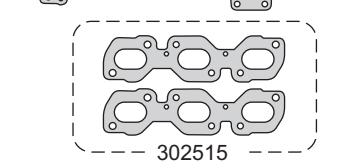
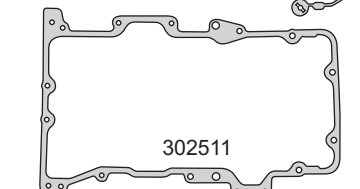
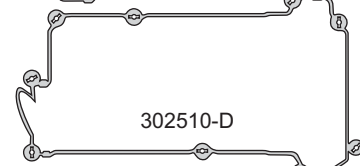
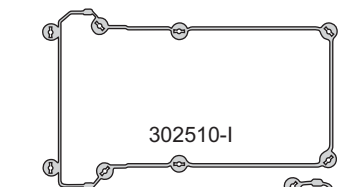
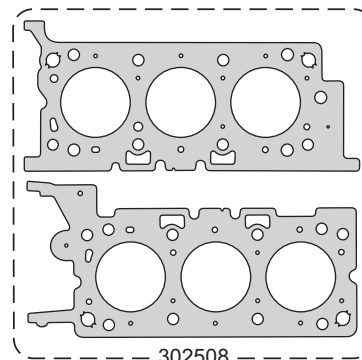

FORD

FORD**taranto**Motor/Engine  **Cm³** **HP** **Ø****Triton 281 V8** **4600** **180** **92**

Ford: E-Series - Mustang - Grand Marquis
Crown Victoria - Pick Up F250 1997/99
(incluye junta múltiple de admisión con
ventana de gota)

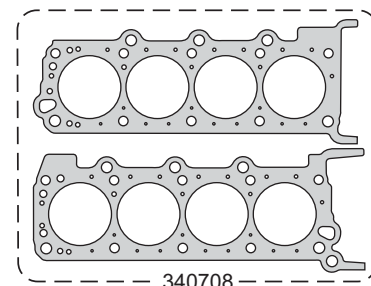

340708

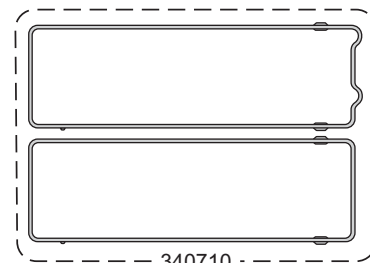

340710

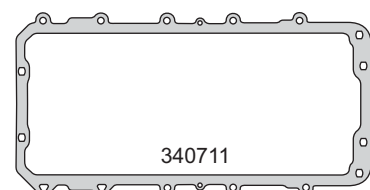

340711

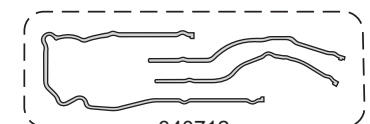

340712

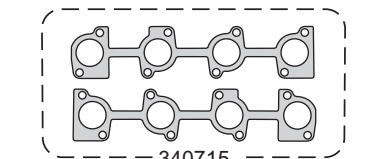

340715

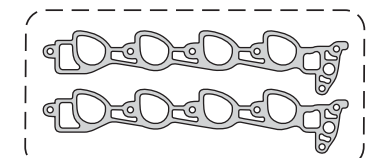

302717

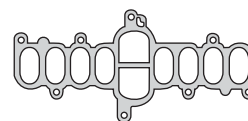

302732

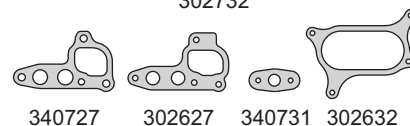

340727

302627

340731

302632

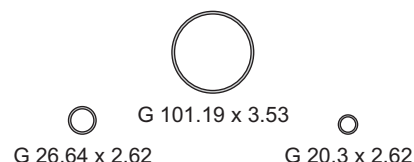

G 101.19 x 3.53

G 26.64 x 2.62

G 20.3 x 2.62

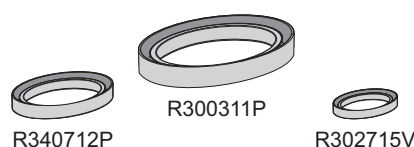

R340712P

R300311P

R302715V

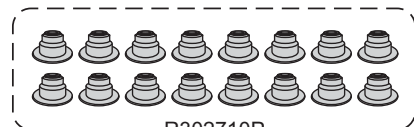

R302710P

Nº OE	Descripción/Description	Mat.	Ref.
	Jgo. de juntas para motor 		● 302700-RMX
	Jgo. de juntas superior 	●	302795
	Jgo. junta tapa cil. Ø 93 ± 1.30 (2)  N.R. 	NFT	340707
	Jgo. junta tapa cil. Ø 92 ± 0.88 (2)  N.R. 	MLS	1 1 340708
	Conj. junta tapa válvulas (2) 	S	1 1 340710
	Junta para cárter 	PLAST	1 340711
	Jgo. cierre distribución (3) 	S	1 1 340712
	Jgo. múltiple escape (2) 	NFT	1 1 340715
	Jgo. múltiple admisión (2) 	PLAST	1 1 302717
	Base bomba aceite	PLAST	1 340727
	Base bomba aceite	PLAST	1 302627
	Junta varilla aceite	NFT	1 1 340731
	Junta entre colectores admisión	CB	1 1 302632
	Junta pleno admisión	PLAST	1 1 302732
	Junta o'ring tubo conector agua G 26.64 x 2.62	AL/GS	1 302534
	O'ring G 101.19 x 3.53	GS	1
	O'ring G 20.3 x 2.62	GS	1
	Kit de retenes completo 		R302700
	Jgo. retén válvulas (16) 	P	1 R302710P
	Retén bancada 92 x 108 x 9.8 	P	1 R300311P
	Retén distribución 47 x 63.4 x 8.8 	P	1 R340712P
	Retén auxiliar 47.63 x 63.5 x 8.5/12.3 	V	1 R302715V

FORD



Motor/Engine Cm³ HP Ø

Triton 281 V8 4600 180 92

Ford: E-Series - Mustang - Grand Marquis
Crown Victoria - Pick Up F250 2000/03
(incluye junta múltiple de admisión con
ventana cuadrada)



Nº OE	Descripción/Description	Mat.		Ref.
	Jgo. de juntas para motor		●	302800-RMX
	Jgo. de juntas superior		●	302895
	Jgo. junta tapa cil. Ø 93 ±1.30 (2) N.R.	NFT		340707
	Jgo. junta tapa cil. Ø 92 ±0.88 (2) N.R.	MLS	1 1	340708
	Conj. junta tapa válvulas (2)	S	1 1	340710
	Junta para cárter	PLAST		340711
	Jgo. cierre distribución (3)	S	1 1	340712
	Jgo. múltiple escape (2)	NFT	1 1	340715
	Jgo. múltiple admisión (2)	PLAST	1 1	322617
	Base bomba aceite	PLAST		340727
	Base bomba aceite	PLAST		302627
	Junta varilla aceite	NFT	1 1	340731
	Junta entre colectores admisión	CB	1 1	302632
	Junta pleno admisión	PLAST	1 1	302732
	Junta o´ring tubo conector agua G 26.64 x 2.62	AL/GS		302534
	O´ring G 101.19 x 3.53	GS		1
	O´ring G 20.3 x 2.62	GS		1
	Kit de retenes completo			R302700
	Jgo. retén válvulas (16)	P	1	R302710P
	Retén bancada 92 x 108 x 9.8	P	1	R300311P
	Retén distribución 47 x 63.4 x 8.8	P	1	R340712P
	Retén auxiliar 47.63 x 63.5 x 8.5/12.3	V	1	R302715V

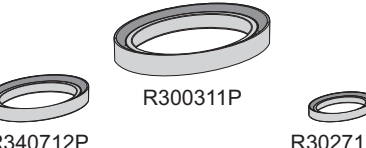
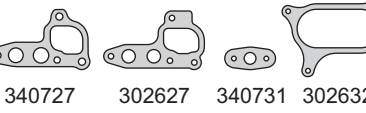
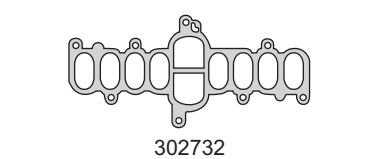
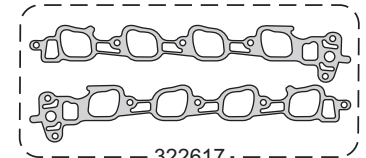
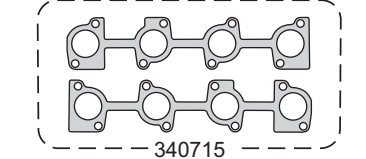
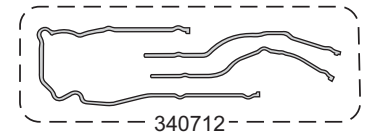
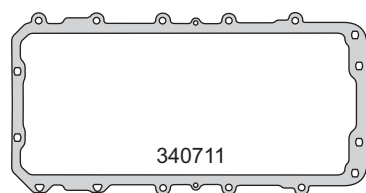
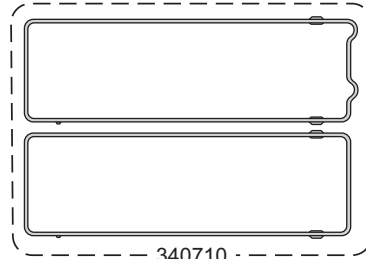
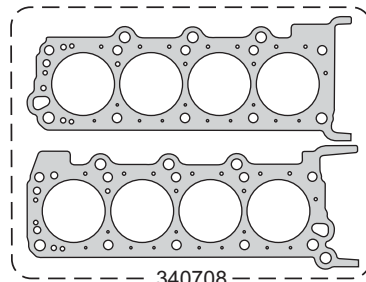

FORD

FORD



Motor/Engine	Cm³	HP	Ø
YF	1989	124	84.8
EDBA-EDBB	1989	124	84.8
EDBC-EDBD (DOHC) 16V	1989	131	84.8

Ford: Focus 1999/02
Maverich 2000/... - Cougar 1999/...



Nº OE	Descripción/Description	Mat.	Ref.
	Jgo. de juntas para motor		302900-R
	Jgo. de juntas superior (MLS)		302995 MLS
1105772	Junta tapa cilindros Ø 87 ± 1.20	NFT	1 301607
	Junta tapa cilindros Ø 86 ± 0.65	MLS	1 301608
	Jgo. tornillos tapa cil. (HAT55055/HAT55100)		B320300
1126120	Junta tapa válvulas	GS	1 1 302910
1078307	Junta para cárter	N	1 301511
1211001	Frente y bomba de aceite	SLS	1 303312
1067759	O´ring bomba de agua G 69.44 x 3.53	GS	1 303314
1053902	Múltiple escape	AC	1 1 301515
1090949	Jgo. múltiple admisión 1999/... (4)	V	1 1 302917
1088965	Salida de escape	AC	302918
	Salida de escape a catalizador	AC	320918
1115070	Guarnición cierre bomba de agua	SLS	303319
958F/9F671/B	Válvula IAC reguladora marcha lenta	N	1 1 340133
978Z/6344AA	Junta bancada trasera	SLS	1 303334
7090340	Múltiple admisión a inyección	GS	303336
1053869/1	Junta sobre carter inferior	NB	1 301538
6974940	Guarnición base termostato	GS	320339
1092262	Guarnición termostato	GS	1 310940
	Kit de retenes completo		R320300
1086431/2	Jgo. retén válvulas (16)	V	1 R320310V
1045520	Retén bancada 88 x 108 x 10	V	1 R320311V
1102415	Retén distribución 35 x 50 x 7	V	1 R470013V
1063822	Retén árbol levas 42 x 53 x 7	V	2 R320313V

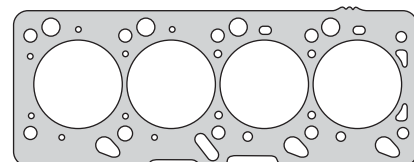

301607

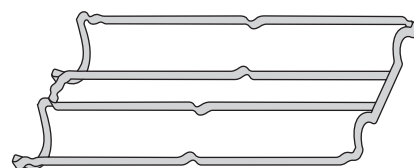

302910

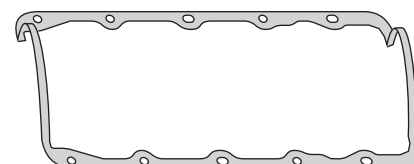

301511

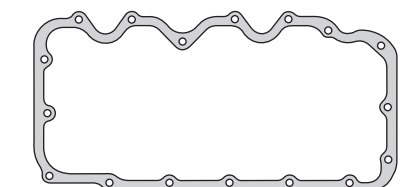

301538



301515



302917



303312



303314



303319



340133



303334



320918



320339



310940



R320311V



R470013V



R320313V

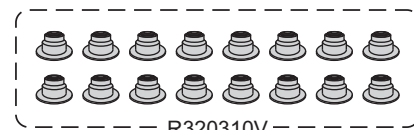

R320310V

FORD

FORD



Motor/Engine	Cm³	HP	Ø
Duratec SEA (DOHC) 24V	2544	170/173	82.4

Ford: Mondeo II 1994/00



Nº OE	Descripción/Description	Mat.	Ref.
	Jgo. de juntas para motor		303000-R
4129204/05	Jgo. junta tapa cil. Ø 83.5 ± 0.85 (2)	MLS	1 303008
3047926	Jgo. de tornillos para tapa de cilindros		B302500
7381330	Junta tapa de válvulas izq.	N	1 302510-I
7381327	Junta tapa de válvulas der.	N	1 302510-D
4139726	Junta para cárter	GS/AL	1 302511
7224827	Junta distribución central	N	1 302512-1
7224828	Junta distribución izq.	N	1 302512-2
7224826	Junta distribución der.	N	1 302512-3
4503102	Jgo. múltiple escape (2)	AC	1 302515
3902545	Jgo. múltiple admisión inf. (2)	PLAST	1 302517-1
3523225	Jgo. múltiple admisión sup. (2)	PLAST	1 302517-2
13342711	O'ring termostato G 47.22 x 3.53	GS	1 302531
7318043	Junta válvula mariposa	NFT	1 302532
3699184	Junta abertura bujía	S	6 302533
7156577	O'ring tubo conector agua G 26.64 x 2.62	GS	6 302534
3780203	O'ring refrigerador aceite G 66.27 x 3.53	GS	1 302535
	Kit de retenes completo		R303000
	Jgo. retén válvulas (24)	V	1 R302510V
F4AZ.6701.A	Retén bancada 92 x 107.58 x 9.5	V	1 R302511V
F3AE.6700.A	Retén distribución 47 x 63.4 x 8.8	P	1 R340712P

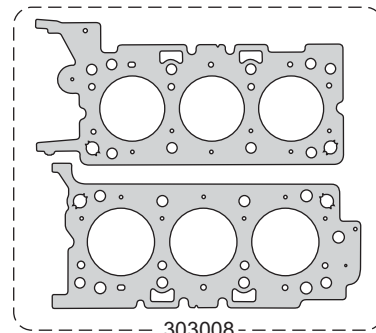

303008

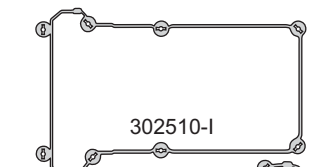

302510-I



302510-D

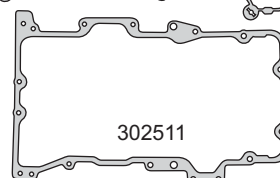

302511

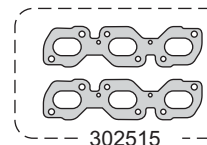

302515

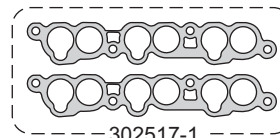

302517-1

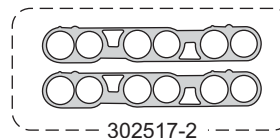

302517-2

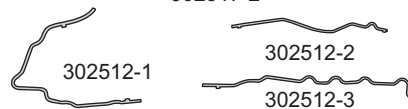

302512-1

302512-2

302512-3

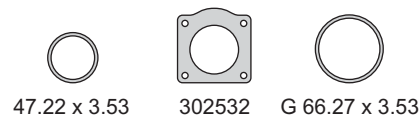

47.22 x 3.53

302532

G 66.27 x 3.53



302533



G 26.64 x 2.62

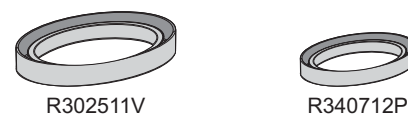

R302511V

R340712P

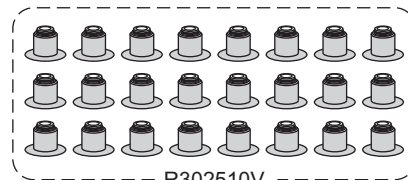

R302510V

FORD

FORD**taranto**

Motor/Engine

Cm³

HP

Ø

Duratec V6
MEBA V6
(DOHC) 24V2967
2967226
22689
89

Ford: Mondeo V6 - ST 2.20 2003/...



Nº OE	Descripción/Description	Mat.	Ref.
	Jgo. de juntas para motor		303100-R
4.44.9245/3561	Jgo. junta tapa cil. Ø 91.5 \pm 0.85 (2)	MLS	1 303108
73.8133G	Jgo. de tornillos para tapa de cilindros		B302500
73.8133G	Junta tapa válvulas izq.	N	1 302510-I
73.81327	Junta tapa válvulas der.	N	1 302510-D
4139726	Junta para cárter	GS/AL	1 302511
7224827	Junta distribución central	N	1 302512-1
7224828	Junta distribución izq.	N	1 302512-2
7224826	Junta distribución der.	N	1 302512-3
4503102	Jgo. múltiple escape (2)	AC	1 302515
4406061	Jgo. múltiple admisión (2) sup.	PLAST	1 303117-1
4367441	Jgo. múltiple admisión (2) inf.	PLAST	303117-2
13342711	O'ring termostato G 47.22 x 3.53	GS	1 302531
7318043	Junta válvula mariposa	NFT	1 302532
3699184	Junta abertura bujías	S	6 302533
7156577	O'ring tubo conector agua G 26.64 x 2.62	GS	6 302534
3780203	O'ring refrig. aceite G 66.27 x 3.53	GS	1 302535
	Kit de retenes completo		R303000
	Jgo. retén válvulas (24)	V	1 R302510V
F4A2.6701A	Retén bancada 92 x 107.58 x 9.5	V	1 R302511V
F3AE.6700A	Retén distribución 47 x 63.4 x 8.8	P	1 R340712P

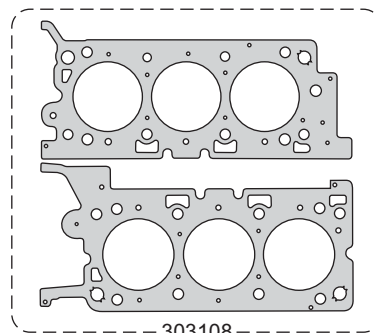

303108

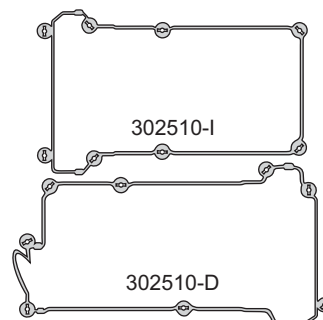

302510-I

302510-D

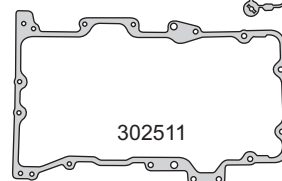

302511

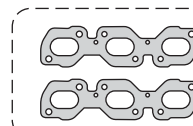

302515

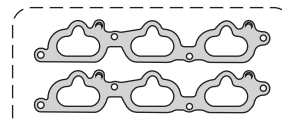

303117-1

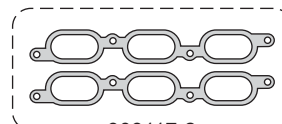

303117-2

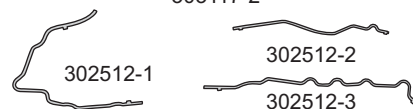

302512-1

302512-2

302512-3

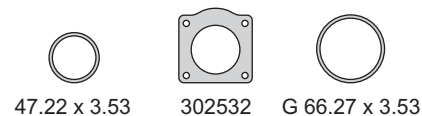
47.22 x 3.53

302532

G 66.27 x 3.53

302533

G 26.64 x 2.62

R302511V

R340712P

R302510V

FORD

231

FORD



Motor/Engine	Cm³	HP	Ø
HJBA/B/C	1998	85	86
F3FA/F1FA	1998	85/125	86
ABFA/D3FA	1998	75/100	86
D5BA/D6BA (DOHC) 16V	1998	90/115	86

Ford: Mondeo TDCI 2000/02 - 2002/...
 Mondeo III DI 2002/02
 Transit TDI-TDCI 2000/02 - 2002/...
 Transit DI 2000/02 - Duratorq



DIESEL

Nº OE	Descripción/Description	Mat.			Ref.
	Jgo. de juntas para motor				303201-R
	Jgo. de juntas superior		●	●	303295
	Jta. tapa cilindros Ø 87 \pm 1.10	NFT			303207-1M
	Jta. tapa cilindros Ø 87 \pm 1.15	NFT			303207-2M
	Jta. tapa cilindros Ø 87 \pm 1.20	NFT			303207-3M
1250940	Jta. tapa cilindros Ø 87 \pm 1.10	MLS			303208-1M
1250941	Jta. tapa cilindros Ø 87 \pm 1.15	MLS			303208-2M
1250942	Jta. tapa cilindros Ø 87 \pm 1.20	MLS			303208-3M
1102674/76	Jgo. de tornillos para tapa de cilindros				B302000
1198000	Junta tapa válvula	N	1	1	302010
1112953	Jgo. junta para cárter (2)	SLS	1	1	302011
	Junta para cárter	NB		1	303211
11026811	Frente distribución	NB	1	1	302012
1121210	Placa tapa delantera distribución	SLS		1	302013
1116916	Bomba de agua	SLS	1	1	303214
1120402	Múltiple escape	AC	1	1	302015
1118392	Jgo. múltiple admisión (9)	N	1	1	302017
	Salida de escape	AC	1	1	302218
1116663	Tubo escape delantero	AC	1	1	303218
11098228	Guarnición termostato	N	1	1	302019
1225037	Base bomba inyectora	SLS		1	340328
1107482	Anillo enfriador aceite G 20 x 26 x 4	GS		1	303229
1130211	Refrigeración recirculación gases	MLS			303230
1203025	Entre válvulas vacío y refrigeración gases	MLS			303231
1114784	Convertidor de escape	AC			303232
	Anillo unión admisión	N	1	1	302033
1130311	O'ring caja termostato G 38 x 4	GS	1	1	303233
	Kit de retenes completo				R302000
1096253	Jgo. retén válvulas (16)	V		1	R302010V
1117435	Porta retén bancada	V			PR302011V
1201417	Porta retén distribución	V			PR302012V
1139357	Retén árbol de levas 35 x 50 x 7	V		1	R470013V

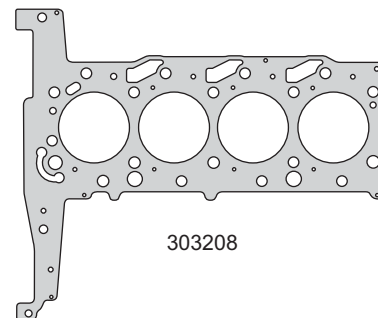

303208

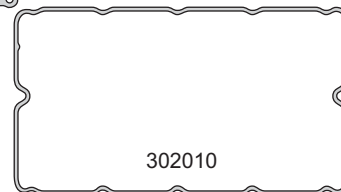

302010

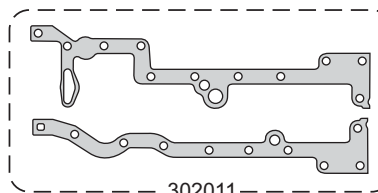

302011

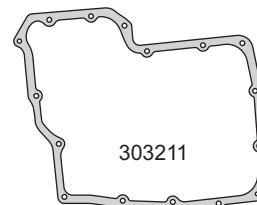

303211

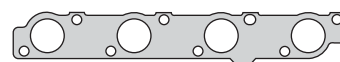

302015

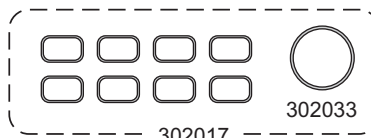

302017

302033

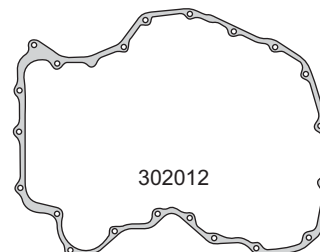

302012

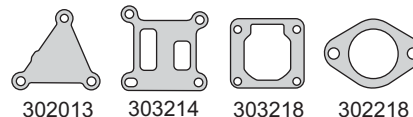

302013

303214

303218

302218



G 38 x 4

302019

340328

303232

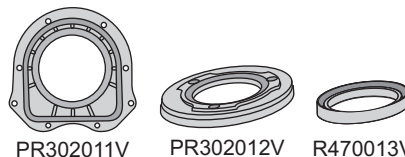

PR302011V

PR302012V

R470013V



R302010V

FORD

FORD



Motor/Engine	Cm³	HP	Ø
ZETEC-E SFI EYDB/C/D/E/F G/I/J/L (DOHC) 16V	1796	116	80.6

Ford: Focus 1998/04
Transit 2002/...



Nº OE	Descripción/Description	Mat.	Ref.
	Jgo. de juntas para motor		303300-R
1308083	Junta tapa cilindros Ø 81.7 ± 1.20	NFT	1 301507
	Junta tapa cilindros Ø 81.5 ± 1.20	MLS	301508
	Jgo. tornillos tapa cilin. (HAT55055/HAT55100)		B320300
1126120	Junta tapa válvulas	GS	1 302910
1078307	Junta para cárter	N	1 301511
1211001	Frente y bomba de aceite	SLS	1 303312
1067759	O´ring bomba de agua G 69.44 x 3.53	GS	1 303314
1053902	Múltiple escape	AC	1 301515
1090949	Jgo. múltiple admisión 1999/... (4)	V	1 302917
1088965	Salida de escape	AC	302918
1115070	Guarnición cierre bomba de agua	SLS	303319
958F/9F671/B	Válvula IAC reguladora marcha lenta	N	1 340133
978Z/6344AA	Junta bancada trasera	SLS	1 303334
1053869/1	Junta sobre carter inferior	NB	1 301538
6974940	Guarnición base termostato	GS	320339
1092262	Guarnición termostato	GS	1 310940
	Kit de retenes completo		R320300
1086431/2	Jgo. retén válvulas (16)	V	1 R320310V
1045520	Retén bancada 88 x 108 x 10	V	1 R320311V
1102415	Retén distribución 35 x 50 x 7	V	1 R470013V
1063822	Retén árbol levas 42 x 53 x 7	V	2 R320313V

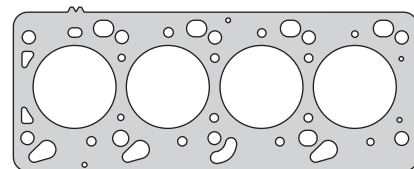

301507

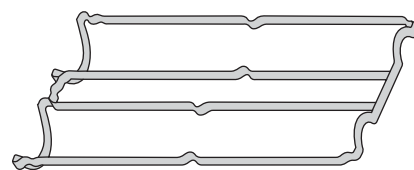

302910

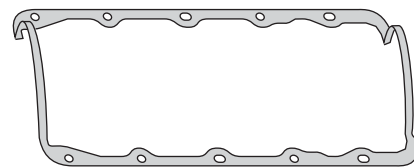

301511

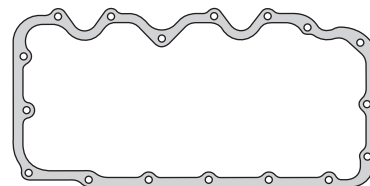

301538



301515



302917



303312



303314



303319



340133



303334



320339



310940



R320311V



R470013V



R320313V

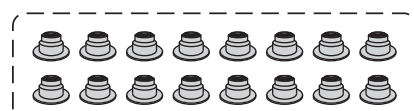

R320310V

FORD



Motor/Engine	Cm³	HP	Ø
AJ25 - LDBE V6 (DOHC) 24V	2495	170	81.6

Ford: Mondeo III 2002/....



Nº OE	Descripción/Description	Mat.			Ref.
	Jgo. de juntas para motor				303500-R
	Jgo. de juntas superior		●	●	303595
	Jgo. jta. tapa cil. Ø 83 ± 0.80 (2)	MLS	1	1	303508
7381330	Junta tapa válvulas izquierda	N	1	1	302510-I
7381327	Junta tapa válvulas derecha	N	1	1	302510-D
4139726	Junta para cárter	AC/GS		1	302511
7224827	Junta distribución central	N		1	302512-1
7224828	Junta distribución izquierda	N		1	302512-2
7224826	Junta distribución derecha	N		1	302512-3
	Bomba de agua	NB		1	302514
6691888	Bomba de agua	CB		1	320314
4503102	Jgo. múltiple escape (2)	AC	1	1	302515
3902545	Jgo. múltiple admisión inferior (2)	PLAST	1	1	302517-1
3523225	Jgo. múltiple admisión superior (2)	PLAST	1	1	302517-2
13342711	Junta o´ring termostato G 47.22 x 3.53	GS		1	302531
7318043	Junta válvula mariposa	NFT	1	1	302532
3699134	Junta abertura bujía	S	6	6	302533
	Guarnición	AC/GS		1	302534
3780203	Junta o´ring refrigerador aceite G 66.27 x 3.53	GS		1	302535
7156577	O´ring tubo conector agua G 26.64 x 2.62	GS	6	6	
	Kit de retenes completo				R303000
	Jgo. retén válvulas (24)	V		1	R302510V
F4AZ-6701A	Retén bancada 92 x 107.58 x 9.5	V		1	R302511V
F3AE-6700A	Retén distribución 47 x 63.4 x 8.8	P		1	R340712P

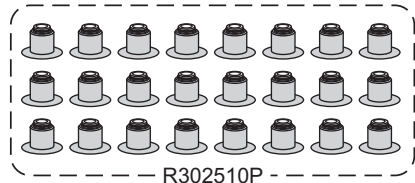
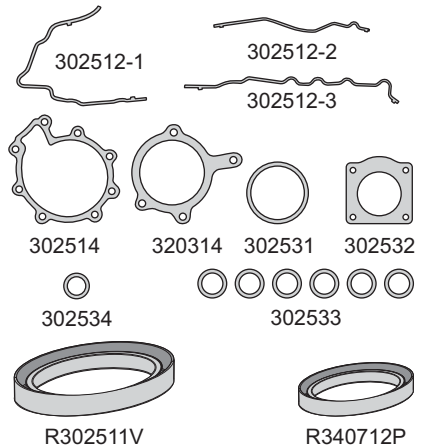
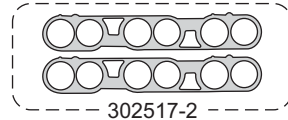
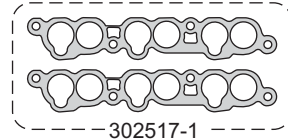
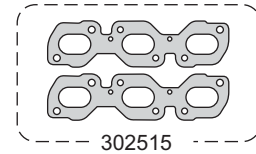
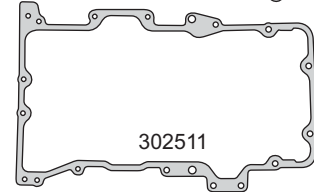
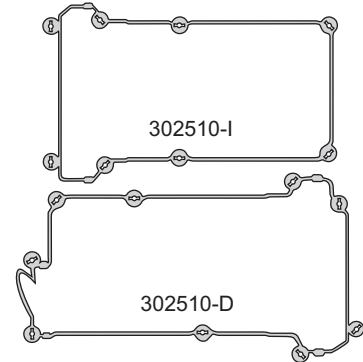
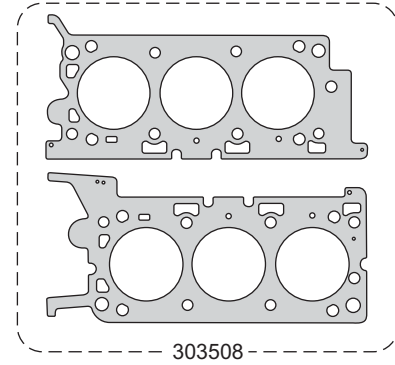

FORD



Motor/Engine	Cm³	HP	Ø
L4 122	1993	72	96
L4 140 (SOHC) 8V	2302	86	96

Ford: Ranger - Pinto - Taunus
Sierra - Capri - Granada 1974/86



Nº OE	Descripción/Description	Mat.	Ref.
	Jgo. de juntas para motor		303600-R
76BR6051A	Junta tapa cilindros Ø 98 ± 1.40	NFT	1 300405
	Junta tapa cilindros Ø 98 ± 1.40		300407
	Jgo. de tornillos para tapa de cilindros		B300300
74BR6584CE	Junta tapa válvulas	CG	1 300310
	Jgo. junta para cárter (4)	CG	1 300311
74BR6020A	Tapa distribución	NB	1 300312
74BR8507A	Bomba de agua	NB	1 300314
78BR9448A	Múltiple escape	NFT	1 300316
74BR9439A	Múltiple admisión	NB	1 300317
	Múltiple admisión sierra	NB	1 300417
	Salida de escape SP	GFT	1 300418-1
74BR8255A	Salida agua termostato	CB	1 300319
74BR6625A	Bomba aceite a block	NB	1 300327
74BR9417A	Base bomba nafta	CB	1 200028
	Tubo llenado aceite	NB	1 300329
	Junta	NH	1 300430
	Junta válvulas E.G.R	NFT	1 321030
	Junta	NFT	1 300431
	Junta	NB	1 300432
	Junta	GS	1 300433
	Junta	GS	2 300434
	Junta	CB	1 340632
	Junta	CB	1 322433
	Junta	NFT	1 322234
	Junta	NFT	1 300435
	Kit de retenes completo		R303600
	Jgo. retén válvulas (8)	P	1 R300310P
	Retén bancada 92 x 106 x 5	P	2 R321811P
	Retén distribución 43.41 x 56.02 x 9.3	P	3 R300312P

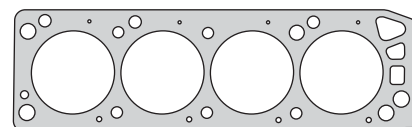

300405

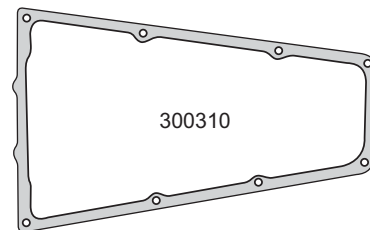

300310

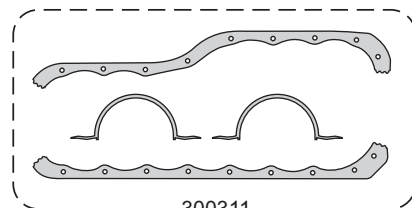

300311



300316

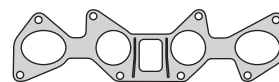

300317



300417



300312

300314

300319

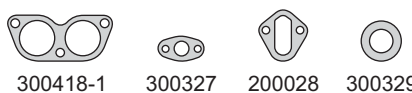

300418-1

300327

200028

300329

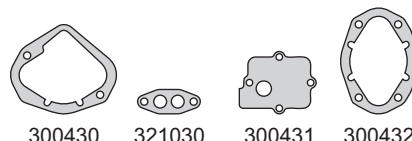

300430

321030

300431

300432



340632

322433

322234

300435

300433

300434

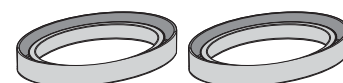

R321811P



R300312P



R300310P

FORD



Motor/Engine	Cm³	HP	Ø
Max Econo	3618	106	93.47

Ford: Falcon - Pick Up 1989/...



Nº OE	Descripción/Description	Mat.	Ref.
	Jgo. de juntas para motor		31000-R
	Jgo. de juntas para motor		31002-R
	Jgo. de juntas superior		310095
	Jta. tapa cilindros Ø 96.7 ± 1.40	NFT 1 1	310005
	Jta. tapa cilindros Ø 96.7 ± 1.40	NFT	310007
CODE6584B	Jgo. de tornillos para tapa de cilindros		B300000
BAC9DZ6781A	Junta tapa válvulas	CG 1 1	300010
BAC9DZ6020A	Jgo. junta para cárter (4)	CG 1	300011
CODE8507A	Tapa distribución	NB 1	300012
BAC9DZ9448A	Bomba de agua	NB 1	300014
C6AZ9450D	Múltiple admisión y escape	NFT 1 1	310016
CODE8255A	Salida de escape	FCH 1 1	300018
BAE-7DZ9502-A	Salida agua termostato	CB 1 1	300019
	Jgo. juntas carburador SOLEX 34 TEIE	VS	310020
	Junta base carburador	NB 1	300025
	Junta base carburador	NB 1	300125
	Base carburador	NB 2	310025
	Tapa cuba carburador	CB	310026
	Bomba aceite	NB 1	300027
BAC9DZ9447A	Bomba nafta	NB 1	300028
C3AZ9417C	Base calefactor	NB 1 1	300031
CODE6626A	Cañería aceite	NB 1	300032
	Tapa diferencial DANA 44	CG	540034
	Salida de escape	H	310040
	Jgo. juntas caja velocidades TRANSAX	VS	300052
C9OZ6701A	Jgo. juntas caja velocidades HUMMEL 5ta.	NH	310053
BAC9DZ6781A	Jgo. empaquetadura bancada (2)	SNA	300058
CODE6584B	Jgo. juntas para cárter	CG	300060
	Tapa válvulas superior	CG	300061
	Porta retén rulemán palier	CB	300065
	Tapa diferencial DANA 44	CGT	540068
	Palier	CB	300069
	Tapa diferencial DANA 44	NH	300086
	Kit de retenes completo		R300000
	Jgo. retén válvulas (12)	P 1	R300010P
	Jgo. retén válvulas capuchones (12)	P	R300010-1P
	Retén bancada 85.7 x 102.62 x 9.73	P 1	R300011P
	Retén reforma bancada 85.7 x 100 x 5.5	P 1	R300911P
	Retén distribución 44.45 x 60.3 x 11.11	P 1	R300012P

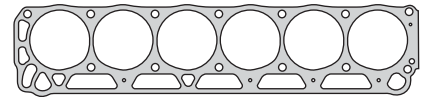

310005



300010

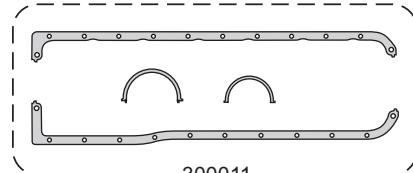

300011

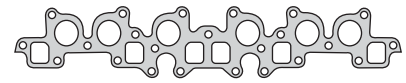

310016

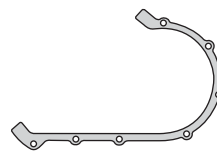

300012



300014



300018



300019

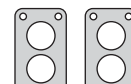

310025

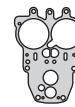

310026



300025

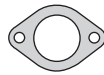

300125



300027



300028

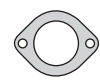

300031



300032

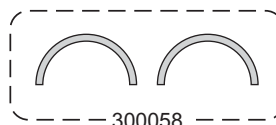

300058



R300011P



R300911P



R300012P

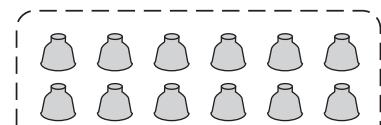

R300010-1P

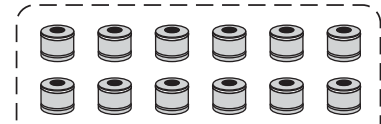

R300010P

FORD



Motor/Engine	Cm³	HP	Ø
F302 V8	4942		101.6

Ford: Ranger 1989/...
Galaxy - Maverick 1976/83



Nº OE	Descripción/Description	Mat.	Ref.
	Jgo. de juntas para motor		● 310100
	Jgo. junta tapa cilindros Ø 104 \pm 1.40 (2)		NFT 1 310105
	Junta tapa de válvulas		CG 2 310110
	Jgo. junta para cárter (4)		CG 1 310111
	Tapa distribución		NB 1 310112
	Tapa bomba de agua		NB 1 310114
	Jgo. múltiple escape (8)		NFT 1 310116
	Jgo. múltiple admisión (2)		NFT 1 310117
	Salida de escape		FCH 2 300018
	Placa bomba de agua		NB 1 310119
	Base bomba nafta		NB 1 540028
	Chupador bomba aceite		NB 1 310129
	Junta termostato		NB 1 310130
	Base Termostato		CB 1 320734
	Salida gases		NB 1 310132
	Base termostato		NB 310134
	Tapa bomba aceite		NB 1 310135
	Unión cierre ADM D		CG 1 310136
	Unión cierre ADM T		CG 1 310137
	Base bomba aceite		NB 1 310141
	Acople bomba aceite		NB 310142
	Jgo. empaquetadura bancada (2)		SNA 1 200658
	Acople bomba aceite		CB 1 320747

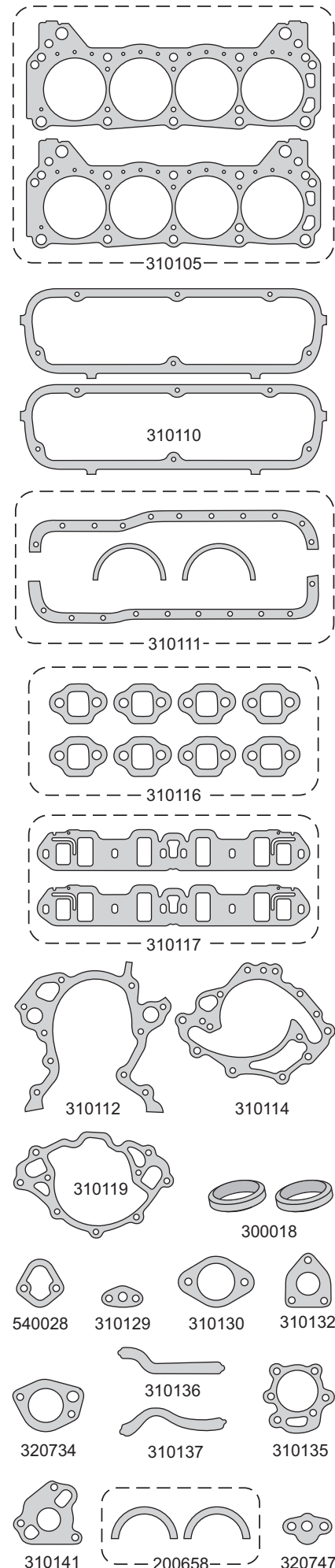

FORD

FORD



Motor/Engine	Cm³	HP	Ø
	4900	145	101.1

Ford: Econoline - Delivery 1980/...



Nº OE	Descripción/Description	Mat.	Ref.
	Jgo. de juntas para motor	●	310200-R
F0UZ-6051A	Junta tapa cilindros Ø 107 \pm 1.70	NFT	1 310205
E9TZ-6584B	Junta tapa válvulas	CG	1 310210
E7TZ-6710B	Jgo. junta para cárter (4)	CG	1 310211
E6TZ-6020B	Tapa distribución	NB	1 310212
C5AZ-8507A	Bomba de agua	NB	1 310214
	Múltiple admisión y escape	NFT	1 310216
	Salida de escape	FCH	2 300018
	Termostato	NB	1 310227
	Arandelas tapa lateral válvulas	GS	400130
E4TZ-6521A	Lateral de válvulas	CG	1 310236
	Kit de retenes completo		R340900
	Jgo. retén válvulas (12)	P	1 R340910P
	Retén bancada 95 x 114.5 x 11	P	1 R340911P
	Retén distribución 47.65 x 65.05 x 11.83	P	1 R300212P

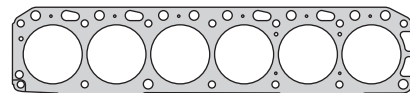

310205

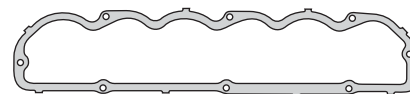

310210

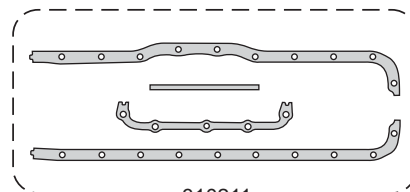

310211



310214



310236

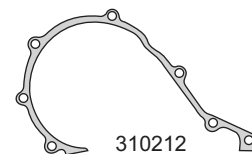

310212

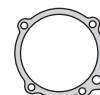

310214



300018



310227



R300212P



R340911P

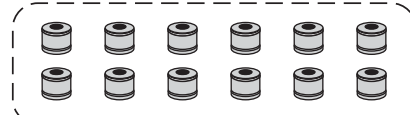

R340910P

FORD

FORD



Motor/Engine **Cm³** **HP** **Ø**

390 CID V8 **5400** **102**

Ford: Fairlane 500 - Galaxy 500 - Monterey
Thunderbird - Mustang 1960/71



Nº OE	Descripción/Description	Mat.	Ref.
	Jgo. de juntas para motor		310300
	Jgo. junta tapa cilin. Ø109 x 1.20 (2)	NFT	1 310307
	Junta tapa válvulas	CG	2 310310
	Junta para cárter	CG	1 310311
	Tapa distribución	CB	1 310312
	Tapa distribución	CB	1 310313
	Bomba de agua	CB	1 310314
	Jgo. múltiple escape (2)	NFT	1 310316
	Jgo. múltiple admisión (4)	NFT	1 310317
	Salida de escape	AC	310318
	Termostato	CB	1 310319
	Bomba aceite	CB	1 310327
	Base bomba nafta	CB	1 200028
	Vaso bomba nafta	CG	1 310333
	Base termostato	CB	1 310334
	Retorno aceite	CB	1 310335
	Salida gases	CB	2 310336
	Guarnición		310337
	Entrada aceite	CB	1 310338
	Succión aceite	CB	1 310339
	Junta	CG	1 310340
	Junta	CG	1 310341
	O´ring G 34.59 x 2.62	GS	1
	Retén distribución 47 x 65 x 10.30	P	R310312P

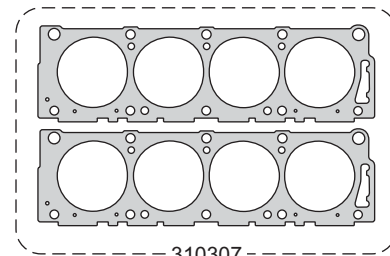

310307

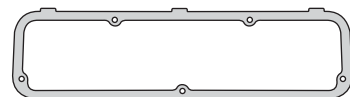

310310



310311

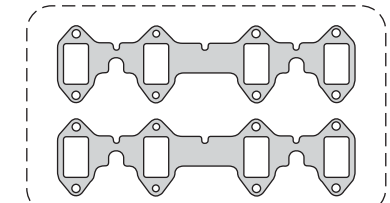
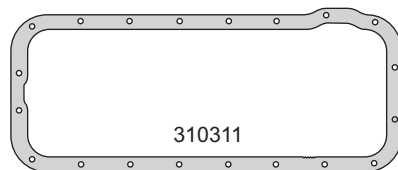

310316

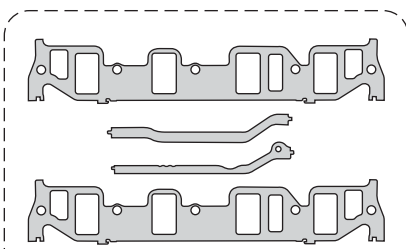

310317

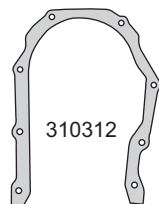

310312

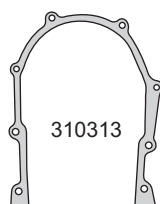

310313



310314

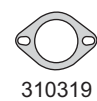

310319

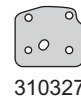

310327



200028



310333



310334



310335



310336



310337



310338

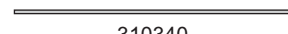

310340



310339

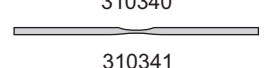

310341



G 34.59 x 2.62



R310312P

FORD

FORD



Motor/Engine	Cm³	HP	Ø
CHT	1555	73	77

Ford: Corcel II 1979/83
Belina II - Pampa 1982/83
Del Rey 1981/83 - Scala 1983/...



Nº OE	Descripción/Description	Mat.	1	2	Ref.	
	Jgo. de juntas para motor				310600-R	
BD9M-6008A	Jgo. de juntas para motor		●		310600	
	Jgo. de juntas superior				310695	
78MU-6051A2	Junta tapa cilindros Ø 78 ± 1.40		NFT	1	1	310605
	Jgo. tornillos tapa cilindros (HAS17038)				B300700	
64293	Conj. junta tapa válvulas (4)		N	1	1	300710
BD9M-6781A	Jgo. junta para cárter (4)		CG		1	300711
BD9M-9448A	Tapa distribución		NB		1	300712
48469	Tapa bomba agua		NB		1	560214
BD9M-6781A	Multiple escape		NFT	1	1	310616
73MU-6020A	Salida de escape		FCH	1	1	550418
48437	Placa bomba de agua		NB		1	560219
BDIM-9417A	Base carburador		NB	2	2	550325
78MV-9417A	Tapa y toma bomba aceite		NB		1	550427
48470	Bomba aceite a block		NB		1	310627
59295	Base bomba nafta		NB		2	250128
75MU-9417A	Bomba nafta a block		NB		2	550428
65689	Bomba nafta		NB		2	310628
7057030	Arandela tapa válvulas A 7 x 17 x 1.5 F		NB	4	4	550430
57101	Tapa trasera tapa cilindros		NB	1	1	310631
65689	Bomba aceite a block		NB		1	310633
6071557	Tapón cárter A 16 x 22 x 1 F		F		1	310634
65583	Base distribuidor		NB		1	550338
78MV-6659A	Llenado aceite		CG	1	1	450041
7703061078	Arandela tapa válvulas		GS	3	3	300742
EOEE-6734AA	Jgo. superior camisa cilindros (0.095) (4)		CU		1	300770-0.095
78MU-6055B	Jgo. superior camisa cilindros (0.115)		S			300770-0.115
78MU-6055C	Jgo. superior camisa cilindros (0.135)		S			300770-0.135
78MU-6055D	Jgo. superior camisa cilindros (0.155)		S			300770-0.155
	Kit de retenes completo					R310600
	Jgo. retén válvulas (8)		V		1	R310810V
78MU-6055A	Retén bancada 82 x 105 x 12		P		1	R300711P
	Reten distribución 35 x 50 x 9		P		1	R550412P

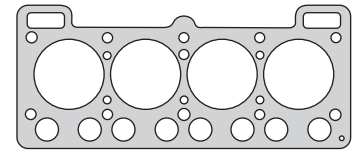

310605

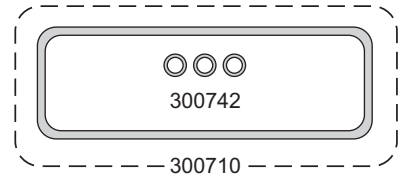

300742

300710

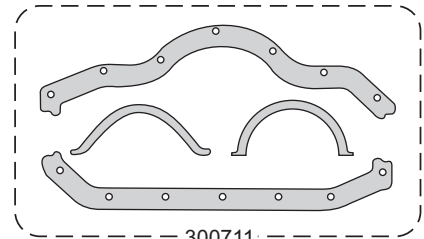

300711



310616

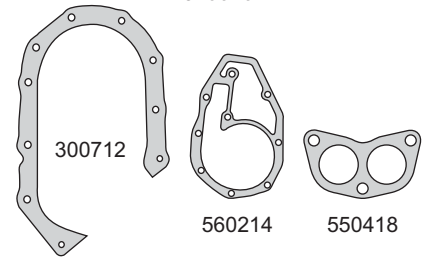

300712

560214

550418



560219

310627

550325



550427

310628

250128

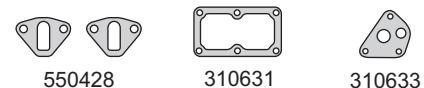

550428

310631

310633

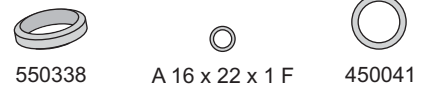

550338

A 16 x 22 x 1 F

450041

A 7 x 17 x 1.5 FA

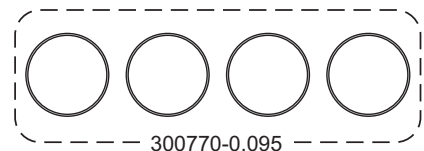

300770-0.095

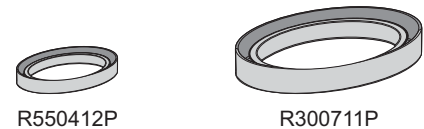

R550412P

R300711P

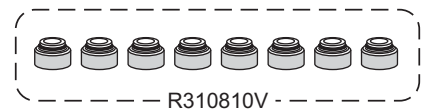

R310810V

FORD

FORD



Motor/Engine	Cm³	HP	Ø
CHT/AE	997		70.3
CHT/AE	1300		71.5

Ford: Escort 1.3 1983/...
Escort Hobby 1.0 1993/...
Volkswagen: Gol 1.0 1993/...



Nº OE	Descripción/Description	Mat.	Ref.
	Jgo. de juntas para motor		310700-R
	Jgo. de juntas superior		310795
84AU/6051/B	Junta tapa cilindros Ø 73 ± 1.40	NFT 1 1	310705
	Jgo. tornillos tapa cilindros (HAS17038)		B300700
64293	Conj. junta tapa válvulas (4)	N 1 1	300710
81NUNV6710/A	Jgo. junta para cárter (4)	CG 1 1	300711
73MU6020-A	Tapa distribución	NB 1 1	300712
84AU8513/A	Tapa bomba de agua	NB 1 1	300714
84AU9448/B	Multiple escape	NFT 1 1	300716
84AU9435-A	Entre múltiple	NFT 1 1	300717
841253115B	Salida de escape	FCH 1 1	220418
84AU9451/A	Salida de escape	FCH 1 1	300718
86AU-8507-AA	Base bomba de agua	NB 1 1	300719
78MU6659A	Toma y tapa bomba de aceite	NB 1	550427
65689	Bomba de aceite	CB 1	300727
75MU9417A	Base bomba de nafta	NB 2	300728
84AU-6W021-A	Placa tapa de cilindro	NB 1 1	300729
84AU8507A	Base bomba agua	NB 1 1	300731
6071557	Base distribuidor	NB 1	550338
E0EE6734AA	Arandela tapón cárter A 15 x 21 x 2 A	AL 1	300730
65583	Arandela tapa válvulas	GS 3 3	300742
78MU6055A	Jgo. superior camisas cilindros (0.095) (4)	CU 1	300770-0.095
	Jgo. superior camisas cilindros (0.125)	CU	300770-0.125
	Jgo. superior camisas cilindros (0.135)	CU	300770-0.135
	Jgo. superior camisas cilindros (0.155)	CU	300770-0.155
	Kit de retenes completo		R310600
	Jgo. retén válvulas (8)	V 1	R310810V
	Retén bancada 82 x 105 x 12	P 1	R300711P
	Retén distribución 35 x 50 x 9	P 1	R550412P

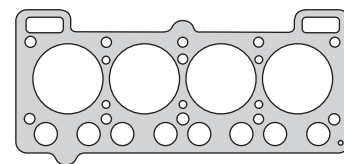

310705

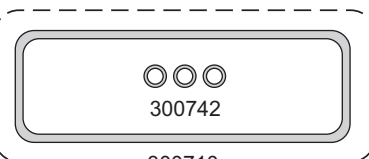

300742

300710

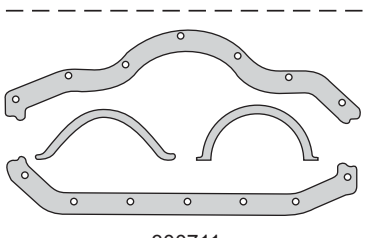

300711

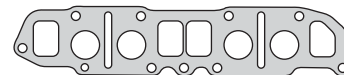

310716

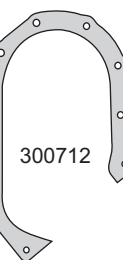

300712



300714



300717

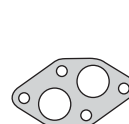

300718

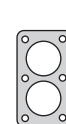

220418



300719



300727



300728



550427

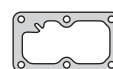

300729



300731



550338



A 15 x 21 x 2 A

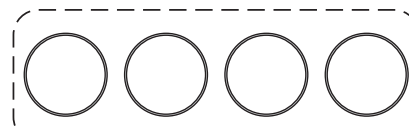

300770-0.095



R550412P



R300711P



R310810V

FORD

FORD



Motor/Engine	Cm³	HP	Ø
OHV (HCS)	1297	50/60	73.96
OHV (HCS)	1299	50/60	73.96
Endura			

Ford: Fiesta 1988/95 - Courier 1991/...
 Fiesta - Ka (cárter de acero)
 Escort - Fiesta - Courier - Ka
 (cárter de aluminio)1995/...



Nº OE	Descripción/Description	Mat.	1	2	Ref.
	Jgo. de juntas para motor			●	310800-R
	Jgo. de juntas superior		●		310895
6176727	Junta tapa cilindros Ø 76 ±1.40		NFT	1	310805
	Junta tapa cilindros Ø 76 ±1.40		NFT		310807
	Jgo. tornillos tapa cilindros (HAS14038)				B310800
6038115	Junta tapa válvulas		CG	1	310810
6707927	Jgo. junta para cárter (4) 1988/95		CG	1	310811
6165295	Tapa distribución		CB	1	310812
6189107	Bomba de agua		CB	1	310814
7126483	Jgo. múltiple de escape (4)		FCH	1	310815
6173339	Múltiple de admisión 1988/95		NB	1	310817
	Salida de escape		NFT	1	310818
1628164	Termostato		CB	1	310819
1651769	Bomba de aceite		CB	1	310827
	O'ring bomba nafta G 23.52 x 1.78		GS	1	310828
6165221	Bancada trasera		CB	1	310829
6660137	O'ring int. para bomba aceite G 23.39 x 3.53		GS	2	310830
	Arandela tapón cárter A 15 x 21 x 2 A		AL	1	310831
	Múltiple admisión - Fiesta 1299cc. 1995/...		NB	1	310832
	Acople caño escape		AC/GS		310840
	Junta para cárter (para cárter aluminio)		AL/GS		310860
	Jgo. caja de velocidades		VS		300750
	Jgo. suplemento tapa de cilindros (4) (0.50)		AC		310885-0.50
	Kit de retenes completo				R310800
	Jgo. retén válvulas (8)		V	1	R310810V
	Retén bancada 79.38 x 95.25 x 11.11		V	1	R300611V
	Retén distribución 36.51 x 52.48 x 8		P	1	R310812P

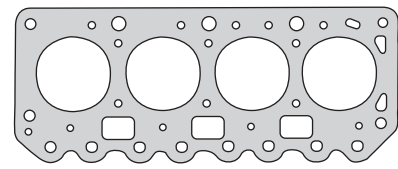

310805

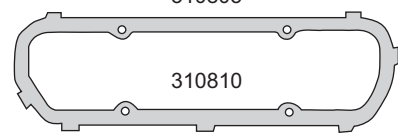

310810

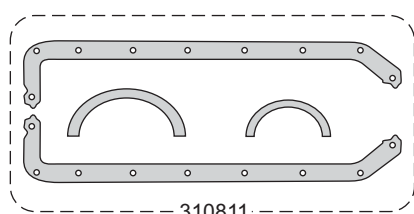

310811

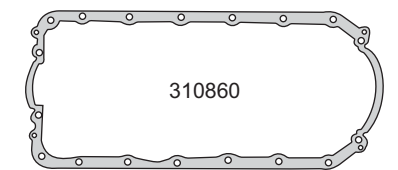

310860

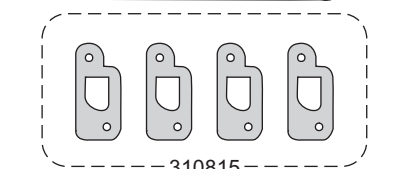

310815

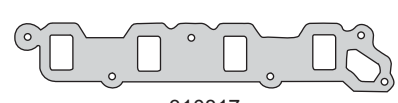

310817

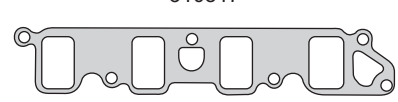

310832



310812



310814



310818

310819

310829



310827

310828

310830

310840

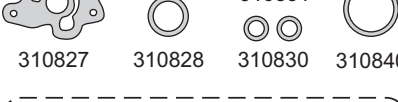

310831



310885-0.50

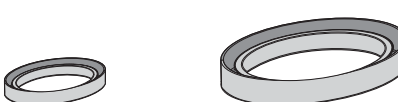

R310812P

R300611V

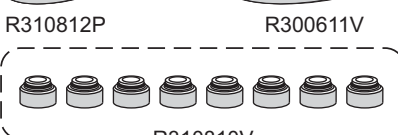

R310810V

FORD

FORD



Motor/Engine **177/BRC V6** Cm³ **2933** HP **150** Ø **93**

Ford: Ford V6 (USA) Ranger - Bronco II 1988/92
Sierra V6 B4A/B/C 1989/93
Granada BRC 1986/93



Nº OE	Descripción/Description	Mat.	Ref.
	Jgo. de juntas para motor		310900-R
	Jgo. de juntas superior	●	310995
	Jgo. jta. tapa cil. Ø 95 ± 1.40 (2) N.R.®	NFT 1 1	310907
	Jgo. de tornillos JTC (HAT55055/HAT55100)		B310900
	Junta tapa válvulas	CG 2 2	310910
	Junta para cárter	N 1	310911
	Tapa distribución	CB 1	310912
	Tapa bomba de agua	CB 1	310914
	Jgo. múltiple escape (2)	NFT 1 1	310915
	Junta tapa admisión	NFT 1 1	310917
	Superior admisión	CB 1 1	310926
	Succión aceite	NFT 1	310927
	Arandela drenaje A 14 x 21 x 2	PLAST 1	310930
	Superior admisión	CB 1 1	310931
	Superior admisión	CB 1 1	310932
	Superior admisión	CB 1 1	310933
	Entrada aire	CB 1 1	310934
	Bomba aceite	NFT 1 1	310935
	Cuerpo válvula cierre	CB 1 1	310936
	Cuerpo válvula cierre	CB 1	310937
	Entrada aceite	CB 1	310938
	Sello de agua	GS 1	310940
	O´ring G 17.12 x 2.62	GS 1	
	O´ring G 21.89 x 2.62	GS 1	
	O´ring G 24 x 30 x 3.9	GS 2	
	O´ring G 26.64 x 2.62	GS 1	
	O´ring G 61.60 x 2.62	GS 1	
	O´ring G 63.09 x 3.53	GS 1	
	Kit de retenes completo		R310900
	Jgo. retén válvulas (12)	P 1	R310910P
	Retén bancada 60.45 x 76.18 x 10	V 1	R320111V
	Retén distribución 42 x 56 x 7	V 1	R300612V

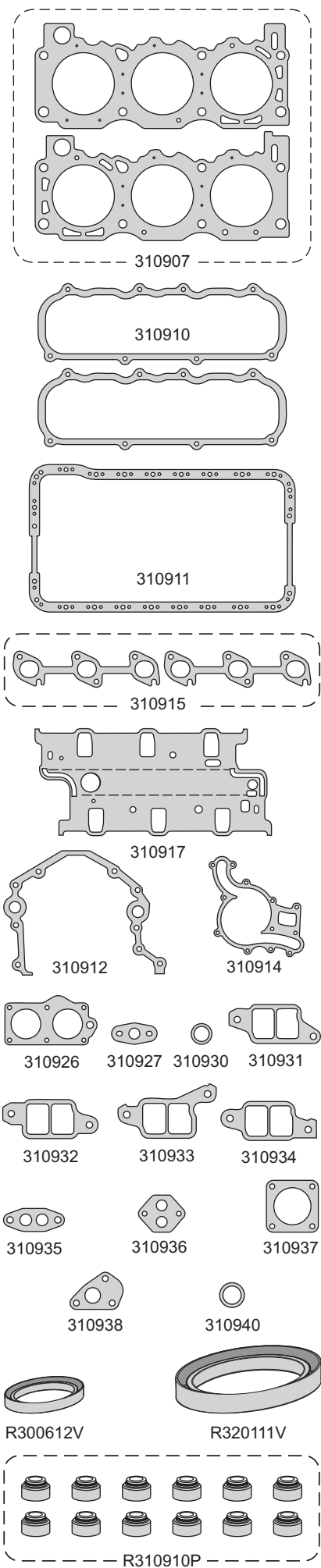

FORD

FORD



Motor/Engine	Cm³	HP	Ø
OHV (HCS) Endura	999	45/53	68.7

Ford: Ka 1997/99 - Fiesta 1996/99 53HP
Fiesta 1988/95 45HP



Nº OE	Descripción/Description	Mat.		Ref.
	Jgo. de juntas para motor			311000-R
	Jgo. de juntas superior		●	311095
	Junta tapa cilin. Ø 70.5 ± 1.30		NFT 1 1	311005
	Junta tapa cilin. Ø 70.5 ± 1.30		NFT	311007
	Jgo. tornillos tapa cilindros (HAS14038)			B310800
6038115	Junta tapa válvulas		CG 1 1	310810
6707927	Jgo. junta para cárter (4)		CG 1	310811
6165295	Tapa distribución		CB 1	310812
6189107	Bomba de agua		CB 1	310814
7126483	Jgo. múltiple de escape (4)		NFT 1 1	310815
6173339	Múltiple de admisión		NB 1 1	310817
	Salida de escape		NFT 1 1	310818
1628164	Termostato		CB 1 1	310819
1651769	Bomba de aceite		CB 1	310827
	O'ring bomba nafta G 23.52 x 1.78		GS 1	310828
6165221	Bancada trasera		CB 1	310829
6660137	O'ring int. para bomba aceite G 23.39 x 3.53		GS 2	310830
	Arandela tapón cárter A 15 x 21 x 2 A		AL 1	310831
	Múltiple admisión		NB 1 1	310832
	Acople caño escape		AC/GS	310840
	Junta para cárter (para cárter aluminio)		AL/GS	310860
	Juego caja de velocidades		VS	300750
	Kit de retenes completo			R310800
	Jgo. retén válvulas (8)		V 1	R310810V
	Retén bancada 79.38 x 95.25 x 11.1		V 1	R300611V
	Retén distribución 36.51 x 52.48 x 8		P 1	R310812P

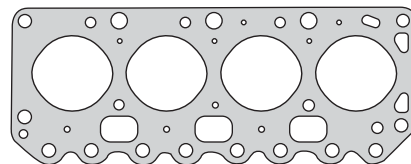

311005

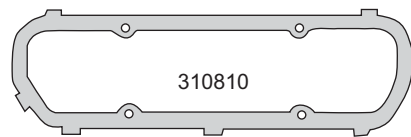

310810

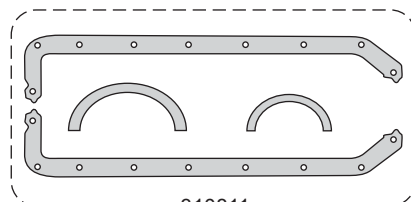

310811

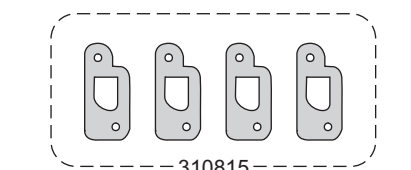

310815

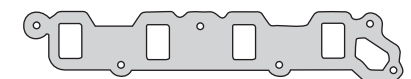

310817

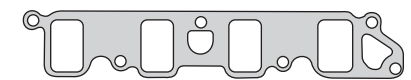

310818

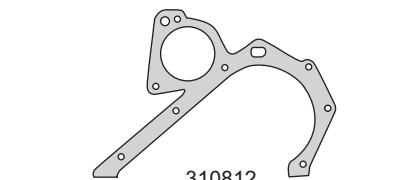

310814



310827



310829



310828



310830

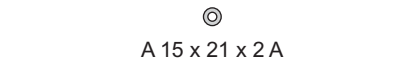

310831



310832



R310810V



R300611V



R310812P

FORD

FORD



Motor/Engine	Cm³	HP	Ø
330 V8	5400		
351 V8	5900		
391 V8	6400		

Ford: Galaxie - Mustang - Torino 1964/78
Camión 1964/78



Nº OE	Descripción/Description	Mat.	Ref.
	Jgo. de juntas para motor		● 311100-RMX
	Jgo. junta tapa cilindros Ø 109 ± 1.20 (2)	NFT	1 311105
	Junta tapa válvulas	CG	2 310310
	Jgo. junta para cárter (3)	CG	1 311111
	Tapa distribución	CB	1 311112
	Bomba de agua	CB	1 310314
	Bomba de agua	CB	2 311114
	Jgo. múltiple escape (2)	NFT	1 311116
	Jgo. múltiple admisión (4)	NB	1 311117
	Termostato	CB	2 310319
	Bomba aceite	CB	1 311127
	Base bomba nafta	CB	1 200028
	Junta unión entre múltiples	GS	2 310330
	Entrada aceite	CB	1 310338
	Succión aceite	CB	1 310339
	O'ring G 7 x 10 x 2	GS	16
	Arandela A 14 x 18 x 1.5 A	AL	1
	Kit de retenes completo		R311100
	Jgo. retén válvulas (8)	P	1 R311110P
	Retén distribución 60.3 x 82.5 x 11		P 1 R330012P

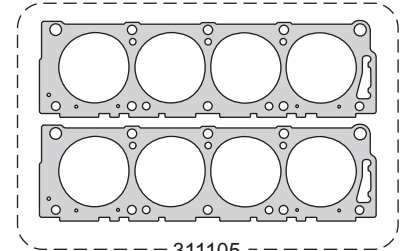

311105

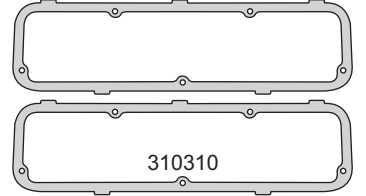

310310

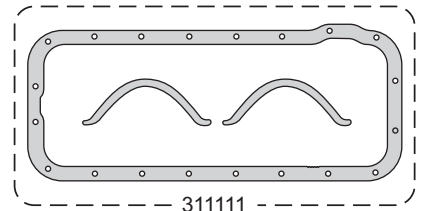

311111

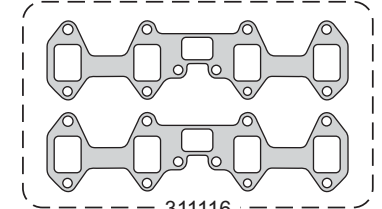

311116

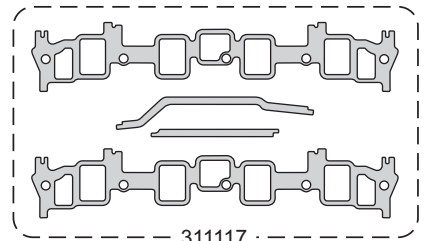

311117

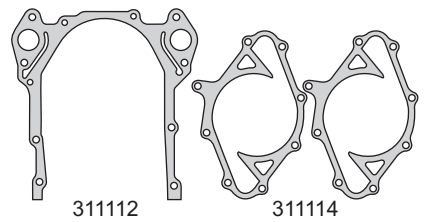

311112

311114

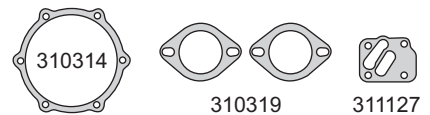

310314

310319

311127

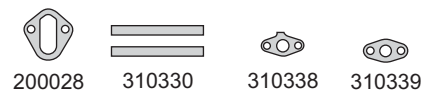

200028

310330

310338

310339



G 7 x 10 x 2

A 14 x 18 x 1.5 A



R330012P

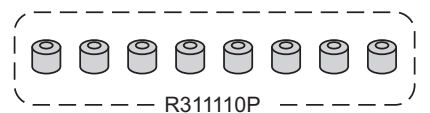

R311110P

FORD



Motor/Engine	Cm³	HP	Ø
350 V8	5400		

Ford: V8 1964/72



Nº OE	Descripción/Description	Mat.	Ref.
	Jgo. de juntas para motor		311200-R
	Jgo. junta tapa cilindros Ø 109 ± 1.20 (2)	NFT 1	311105
	Junta tapa válvulas	CG 2	310310
	Junta para cárter	CG 1	310311
	Tapa distribución	CB 1	311112
	Bomba de agua	CB 1	310314
	Bomba de agua	CB 2	311114
	Jgo. múltiple escape (2)	NFT 1	311116
	Jgo. múltiple admisión (4)	NB 1	311117
	Termostato	CB 2	310319
	Bomba aceite	CB 1	310327
	Base bomba nafta	CB 1	200028
	Junta unión entre múltiples	GS 2	310330
	Guarnición goma	N 1	311230
	Entrada aceite	CB 1	310338
	Succión aceite	CB 1	310339
	Junta	NFT 2	320762
	O'ring G 7 x 10 x 2	GS 16	
	Arandela A 14 x 18 x 1.5 A	AL 1	
	Kit de retenes completo		R311200
	Jgo. retén válvulas (8)	P 1	R311110P
	Retén bancada (dos mitades)	N 1	R311211-1N
	Retén distribución 66.3 x 82.5 x 11	P 1	R330012P

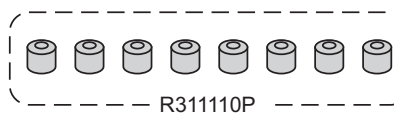
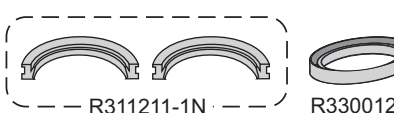
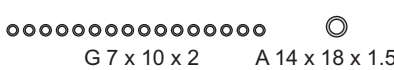
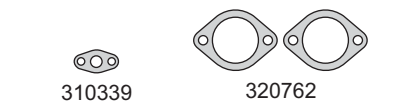
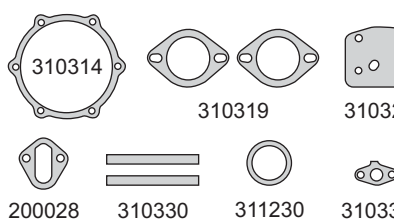
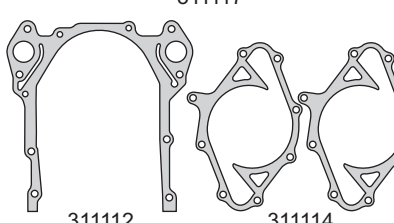
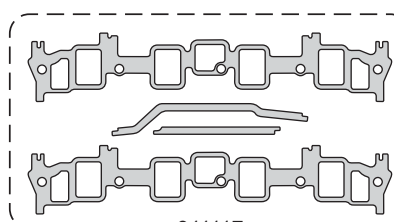
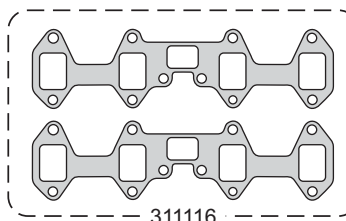
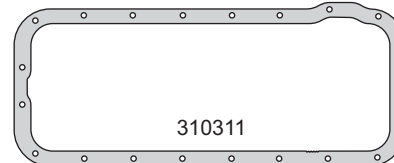
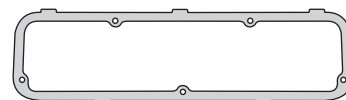
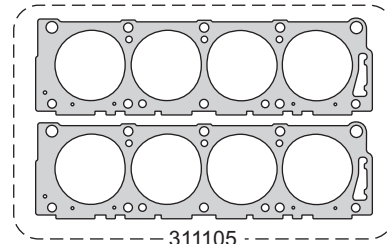

FORD

FORD



Motor/Engine	Cm³	HP	Ø
D1.8	1753	60/75	82.5
D1.8 T/TI	1753	75/90	82.5

Ford: Fiesta - Courier - Escort - Mondeo - Orion D
Sierra TD - Mondeo TD 1991/...
Escort TDI 1994/...

DIESEL



Nº OE	Descripción/Description	Mat.	Ref.
	Jgo. de juntas para motor		320001-R
	Jgo. de juntas superior		320095-2M
	Jgo. de juntas superior		320095-3M
	Jgo. de juntas superior		320095-4M
6.562.341	Junta tapa cilindros Ø 84 \pm 1.40	NFT	1 320007-2M
6.526.342	Junta tapa cilindros Ø 84 \pm 1.45	NFT	320007-3M
6.526.343	Junta tapa cilindros Ø 84 \pm 1.50	NFT	320007-4M
	Jgo. tornillos tapa cilindros (HAT70100)		B320000
6.765.358	Conj. junta tapa válvulas (4)	N	1 1 320010
1.075.963	Junta para cárter	S	1 320011
6.169.448	Junta frente motor	CB	1 320012
6.175.096	Bomba de agua	CB	1 320014
	Múltiple escape	NFT	1 1 320015
	Múltiple escape	AC	320016
6.740.296	Múltiple admisión	CB	1 1 320017
6.180.424	Múltiple admisión turbo	NFT	1 1 340317
6.740.297	Salida de escape turbo	NFT	1 1 320018
6.175.938	Salida de escape	NFT	1 1 310818
6.465.080	Junta termostato	CB	1 1 320019
6.561.244	Guarnición bomba aceite	S	1 320027
1.630.835	Brida trasera	CB	1 320029
	Válvula reguladora gases	AC	3 4 320030
6.465.680	Anillo termostato	GS	1 560131
89FF8255AA	Arandela tapa válvulas	GS	3 3 320033
91FF6344AA	Mando bomba vacío	CB	1 320041
6.148.285	Bomba de agua	CB	1 320042
6.175.909	Guarnición fijación placa de distribución	S	2 320043
1.665.178	Arandela pico inyector	CU	4 4 320044
	Jgo. colector admisión entre múltiples	N	4 4 320047
	Acople caño de escape Fiesta - Courier		320048
	O'ring G 40 x 3	GS	1
	O'ring G 46 x 3	GS	4 4
	O'ring G 20 x 2.5	GS	1
	O'ring G 91 x 1.8	GS	1
	O'ring G 47.22 x 3.53	GS	4
	O'ring G 52.07 x 2.62	GS	1
	O'ring G 53.09 x 3	GS	1
6112230	Arandela tapón cárter A 15 x 21 x 2 A	AL	1
	Kit de retenes completo		R320000
1.644.647	Jgo. retén válvulas (8)	V	1 R320010V
	Retén bancada 79.38 x 95.25 x 11.11	V	1 R300611V
1.078.528	Porta retén bancada	V	PR320011V
	Retén distribución 66.67 x 89.3 x 10	P	1 R320012P
	Retén árbol levas 28 x 38 x 7	V	1 R320013V
	Porta retén auxiliar 40 x 53.50 x 7.5/8.5	V	PR320015V

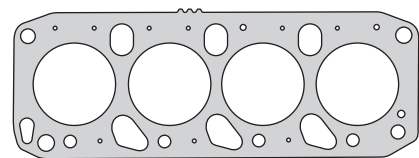

320007

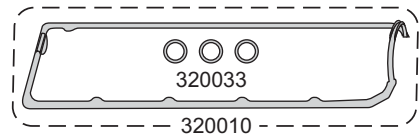

320033

320010

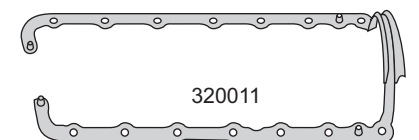

320011



320015

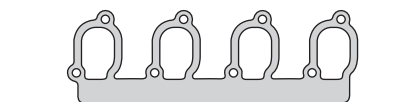

320017



340317



320012

320014

310818

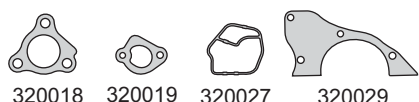

320018

320019

320027

320029

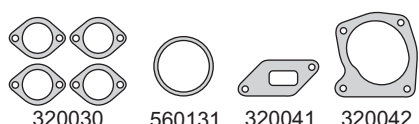

320030

560131

320041

320042



320043

320044

G 20 x 2.5



320047

G 40 x 3



G 47.22 x 3.53

G 52.07 x 2.62



A15 x 21 x 2 A



PR320011V

G 91 x 1.8

PR320015V



R300611V

R320013V

R320012P



R320010V

FORD

FORD



Motor/Engine	Cm³	HP	Ø
244 CID V6 (SOHC) 12V	3996	147/165	100.4

Ford: Explorer - Ranger - Navajo V6 1991/...
Bronco II V6 1990/91



Nº OE	Descripción/Description	Mat.		Ref.
	Jgo. de juntas para motor		●	320100-R
	Jgo. de juntas superior		●	320195
	Jgo. tapa cil. Ø 103.5 ± 1.40 (2)	NFT	1 1	320107
	Jgo. de tornillos JTC (HAT55055/HAT55100)			B310900
	Junta tapa válvulas	CG	2 2	320110
	Junta para cárter	N	1	320111
	Tapa distribución	CB	1	320112
	Tapa bomba agua	CB	1	320114
	Jgo. múltiple escape (2)	NFT	1 1	320115
	Jgo. multiple admisión (2)	CB	1 1	320116
	Junta tapa admisión	NFT	1 1	320117
	Junta adaptador bomba aceite	CB	1	320127
	Junta sello de calce	GS	1	320129
	Junta	NFT	1	320130
	Junta	NFT	1	320131
	Junta	NB	1	320132
	Junta	NFT	1	340731
	Arandela drenaje A 14 x 21 x 2	PLAST	1	310930
	Junta entrada paso aire	CB	1 1	310936
	Junta válvula paso	CB	1 1	310938
	Junta sello agua	GS	1	310940
	Junta cuerpo conducto	CB	1 1	320141
	O'ring bulones G 17.12 x 2.62	GS	1	310942
	O'ring adaptador G 63.09 x 3.53	GS	1	310944
	Limitador torque A 7 x 8.9 x 1.9 A	AC	16	
	Kit de retenes completo			R310900
	Jgo. retén válvulas (12)	P	1	R310910P
	Retén bancada 60.45 x 76.18 x 10	V	1	R320111V
	Retén distribución 42 x 56 x 7	V	1	R300612V

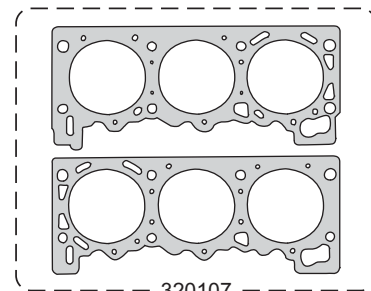

320107

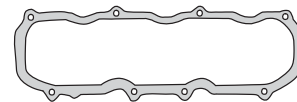

320110



320111



320115

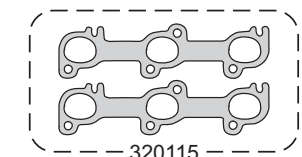

320117

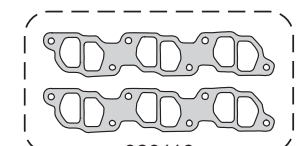
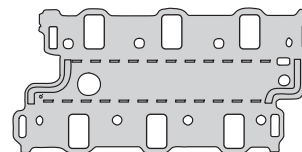

320116

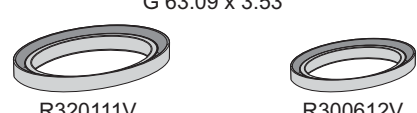
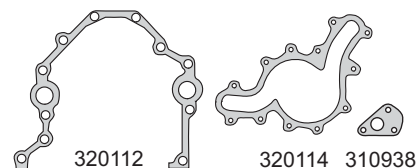

FORD

FORD



Motor/Engine **230 (232) V6** **3811** **130** **96.8**

Ford: V6 3.8 (USA) Mustang - Taurus - Sable
Thunderbird - Cougar



Nº OE	Descripción/Description	Mat.	Ref.
	Jgo. de juntas para motor		320200
	Jgo. tapa cilindros Ø 99.7 ±1.40 (2)	GFT	1 320207
	Junta tapa valvulas	GS	2 320210
	Jgo. junta para cárter (2)	CG	1 320211
	Tapa distribución	CB	1 320212
	Tapa bomba de agua	CB	1 320214
	Jgo. múltiple escape (2)	NFT	1 320215
	Jgo. multiple admisión (2)	NFT	1 320216
	Múltiple admisión superior	NFT	1 320217
	Junta termostato	CB	1 320219
	Junta bomba aceite	CB	1 320227
	Junta succión aceite	NFT	1 310927
	Arandela drenaje cárter	PLAST	1 310930
	Junta cierre admisión delantera	CG	1 320231
	Junta cierre admisión trasera	CG	1 320232
	Junta	CB	1 320235
	Junta entrada aire	CB	1 310936
	O'ring G 34.52 x 3.53	GS	1
	O'ring G 28.24 x 2.62	GS	1

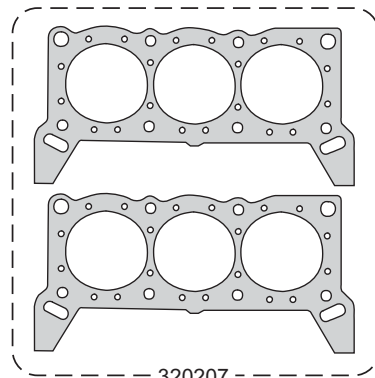

320207

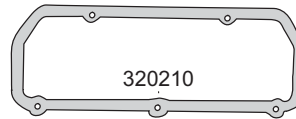
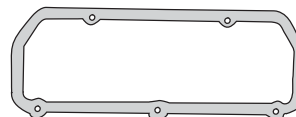

320210

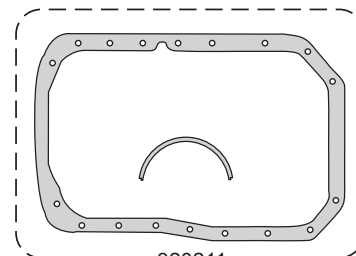

320211

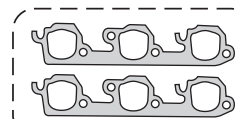

320215

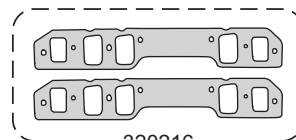

320216



320217

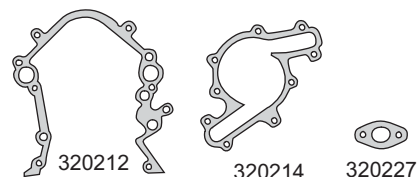

320212

320214

320227



310927

320231

320232

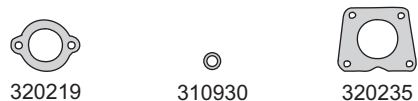

320219

310930

320235



G 34.52 x 3.53

310936

G 28.24 x 2.62

FORD

FORD



Motor/Engine	Cm³	HP	Ø
ZETEC 16V	1796	105/115	80.6

Ford: Escort - Fiesta - Orion - Fiesta XR2
Escort RX3i 1992/...



Nº OE	Descripción/Description	Mat.	1	2	Ref.
	Jgo. de juntas para motor				320300-R
	Jgo. de juntas superior		●	●	320395
6847748	Junta tapa cilin. Ø 81.7 \pm 1.60	NFT	1	1	320307
	Jgo. de tornillos JTC (HAT55055/HAT55100)				B320300
1663394	Conj. junta tapa válvulas (11)	GS	1	1	320310
7008824	Junta para cárter	N		1	320311
7378788	Frente bomba aceite	CB		1	320312
6691888	Bomba de agua	CB		1	320314
7181761	Múltiple escape	NFT	1	1	320316
6669767	Bakelita aislante admisión	BAK	1	1	320317
1048093	Jgo. múltiple admisión 1997/... (4)	N	1	1	320517
	Salida de escape				320318
1663383	Múltiple admisión	CB	1	1	320329
	Junta caja termostato	CB		1	320332
	Válvula IAC	N			320333
1663908	Chupador aceite	CB		1	320334
7090340	Mariposa gases	CB		1	320335
1663861	Bancada trasera	CB		1	320336
6759630	Anillo tapa válvulas G 8.5 x 13.4 x 5	GS	10	10	320337
	Sello de agua	GS	1	1	310940
6692744	Acople caño de escape				320048
	Arandela cárter A 15 x 21 x 2 A	AL		1	
	Kit de retenes completo				R320300
	Jgo. retén válvulas (16)	V		1	R320310V
	Retén bancada 88 x 108 x 10	V		1	R320311V
	Retén distribución 35 x 50 x 7	V		1	R470013V
	Retén árbol levas 42 x 53 x 7	V		2	R320313V

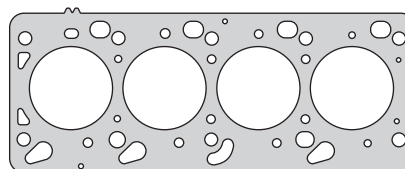

320307

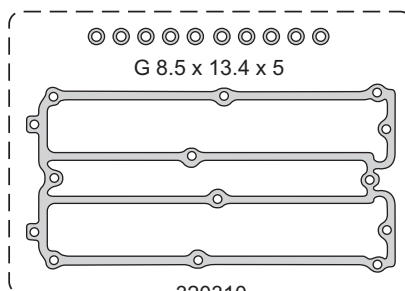

G 8.5 x 13.4 x 5

320310

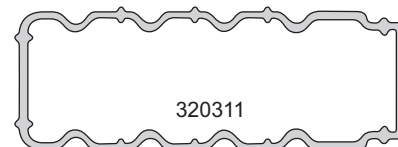

320311



320316

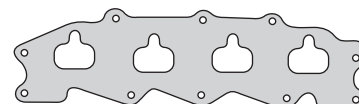

320317



320517

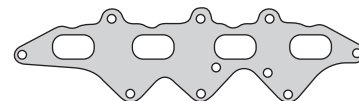

320329



320312



320336



320314



320332



320335



320334



A 15 x 21 x 2A



320333



R320311V



R470013V



R320313V

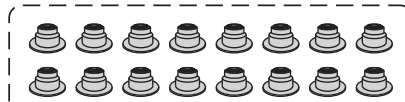

R320310V

FORD

FORD



Motor/Engine **ZETEC 16V** Cm³ **1989** HP **136** Ø **84.8**

Ford: Escort



Nº OE	Descripción/Description	Mat.		Ref.
	Jgo. de juntas para motor			320500-R
	Jgo. de juntas superior			320595
7114447	Jta. tapa cilindros Ø 87 ± 1.70	NFT	1 1	320507
	Jgo. de tornillos JTC (HAT55055/HAT55100)			B320300
1663394	Conj. junta tapa válvulas (11)	GS	1 1	320310
7008824	Junta para cárter	N	1 1	320311
7378788	Frente bomba aceite	CB	1 1	320312
6691888	Bomba de agua	CB	1 1	320314
7181761	Múltiple escape	NFT	1 1	320316
6669767	Bakelita aislante admisión	BAK	1 1	320317
1048093	Jgo. múltiple admisión 1997/... (4)	N	1 1	320517
1663383	Multiple admisión	CB	1 1	320329
	Junta caja termostato	CB	1 1	320332
	Válvula IAC	N	1 1	320333
1663908	Chupador aceite	CB	1 1	320334
7090340	Mariposa gases	CB	1 1	320335
1663861	Bancada trasera	CB	1 1	320336
6759630	Anillo tapa válvulas G 8.5 x 13.4 x 5	GS	10 10	320337
	Sello de agua	GS	1 1	310940
6692744	Acople caño de escape			320048
	Arandela cárter A 15 x 21 x 2 A	AL	1 1	
	Kit de retenes completo			R320300
	Jgo. retén válvulas (16)	V	1 1	R320310V
	Retén bancada 88 x 108 x 10	V	1 1	R320311V
	Retén distribución 35 x 50 x 7	V	1 1	R470013V
	Retén árbol levas 42 x 53 x 7	V	2 2	R320313V

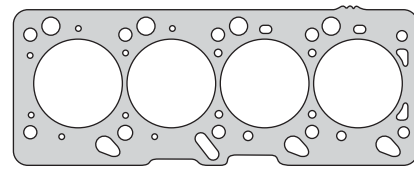

320507

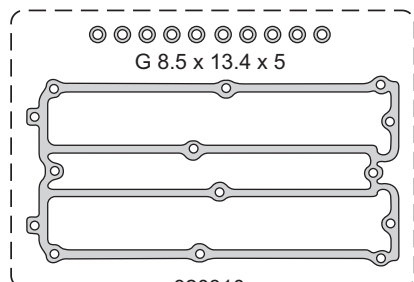

G 8.5 x 13.4 x 5
320310

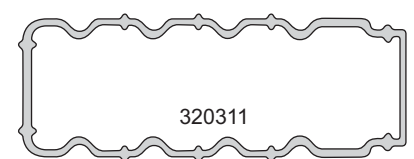

320311



320316

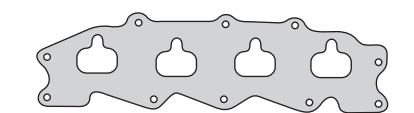

320317

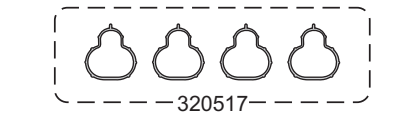

320517

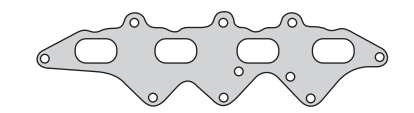

320329



320312



320336



320314

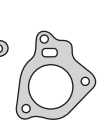

320332

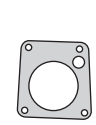

320335



320334



310940



A 15 x 21 x 2 A



320333



R320311V



R470013V

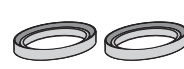

R320313V

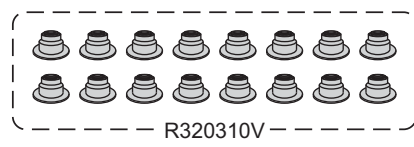

R320310V

FORD

FORD



Motor/Engine	Cm³	HP	Ø
CHT	1300	73	77
CHT	1400	73	77

Ford: Corcel 1971/77 - Corcel II 1978/83
Belina - Coupe GT 1.4 BR



Nº OE	Descripción/Description	Mat.			Ref.
85959	Jgo. de juntas para motor				320600-R
	Jgo. de juntas superior		●	●	320695
78MU-6051A2	Junta tapa cilindros Ø 78 ± 1.40	NFT	1	1	310605
	Jgo. tornillos tapa cilindros (HAS17038)				B300700
64293	Conj. junta tapa válvulas (4)	N	1	1	300710
85958	Jgo. junta para cárter (4)	CG		1	320611
48625	Tapa distribución	NB		1	300712
48437	Tapa bomba de agua	NB		1	560214
48262	Múltiple admisión y escape	NFT	1	1	320616
7ZAU-9451A	Salida de escape	FCH	1	1	300018
48470	Placa bomba de agua	NB		1	560219
	Base carburador	NB	2	2	450025
59295	Base carburador	NB	2	2	550325
78MU-6659A	Tapa y toma bomba aceite	NB		1	550427
65689	Bomba aceite a block	NB		1	310627
BDIM-9417A	Bomba nafta a block	NB		2	550428
BD5M-9417A	Bomba nafta	NB		1	310628
BD5M-9417A	Base bomba nafta	NFT		2	320628
48469	Tapa trasera tapa cilindros	NB	1	1	310631
65689	Bomba aceite a block	NB		1	310633
17138	Tapón cárter A 19 x 24 x 1.5 A	AL		1	320634
6071557	Base distribuidor	NB		1	550338
65583	Arandela tapa válvulas	GS	3	3	300742
	Jgo. suplemento camisa cilindros (4)	CU		1	550470-0.08
	Kit retenes completo				R310600
	Jgo. retén válvulas (8)	V			R310810V
	Retén bancada 82 x 105 x 12	P		1	R300711P
	Retén distribución 35 x 50 x 9	P		1	R550412P

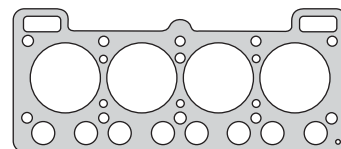

310605

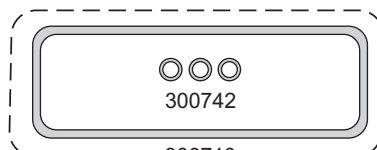

300742

300710

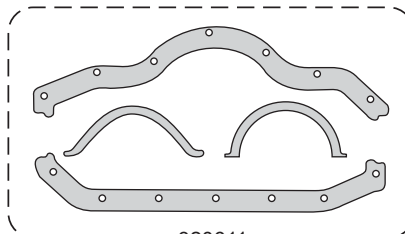

320611



320616

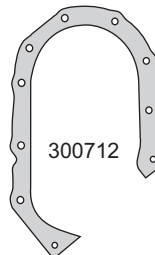

300712



560214



300018



560219



310627

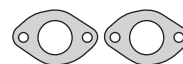

550325

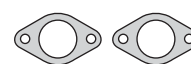

450025



320628



550427



550428



310631



310628



310633



550338



A 19 x 24 x 1.5 A



550470-0.08



R550412P



R300711P



R310810V

FORD



Motor/Engine	Cm³	HP	Ø
F302 V8	5000		101.6

Ford: Cougar - Continental - Granada
Fairmont - Thunderbird



Nº OE	Descripción/Description	Mat.	Ref.
	Jgo. de juntas para motor	●	320700
	Jgo. junta tapa cilindros Ø 104.5 ± 1.20 (2)	NFT	320705
	Jgo. junta tapa cil. Ø 103.5 ± 1.20 (2)	NFT	1 320707
	Junta tapa válvulas	CG	2 320710
	Jgo. junta para cárter (4)	CG	1 320711
	Tapa distribución	CB	1 320712
	Tapa bomba de agua	CB	1 320714
	Tapa bomba de agua	CB	1 320714-1
	Tapa bomba de agua	CB	1 320714-2
	Tapa bomba de agua	CB	1 320714-3
	Jgo. múltiple escape (2)	NFT	1 320715
	Jgo. múltipe admisión (2)	NFT	1 320717
	Salida de escape	FCH	2 300018
	Placa bomba de agua	CB	1 320719
	Bomba de nafta	CB	1 200028
	Chupador bomba de aceite	CB	1 320729
	Tapa bomba de agua	NFT	1 320730
	Base termostato	CB	1 320734
	Salida de gases	CB	1 320735
	Cierre admisión delantera	CG	1 320736
	Cierre admisión trasera	CG	1 320737
	EGR válvula	NFT	1 320739
	EGR tubo cónica 17 x 26	NFT	2 320740
	EGR tubo cónica 20 x 29	NFT	2 320741
	Acople bomba de aceite	CB	1 320744
	Filtro de aire 127 x 140	CB	1 320745
	Filtro de aire 134 x 146	CB	2 320746
	Acople bomba de aceite	CB	1 320747
	Jgo. de juntas sobreadmisión (2)	NFT	1 320748
	Arandela tapón cárter A 13 x 23 x 1.8 N	N	
	O´ring G 32.9 x 2.6	GS	
	Retén distribución 47.65 x 65.05 x 12	N	R300212N

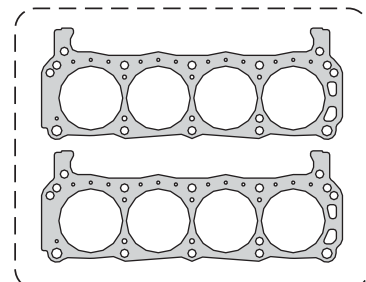

320707

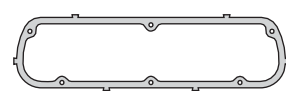

320710

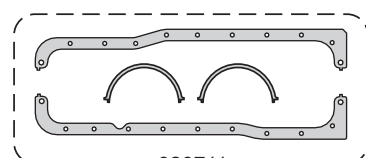

320711

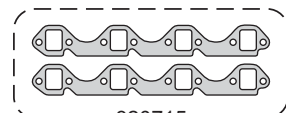

320715

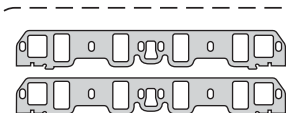

320717

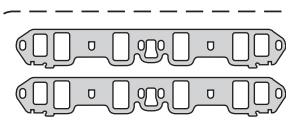

320748

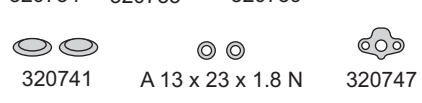
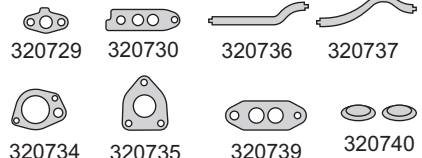
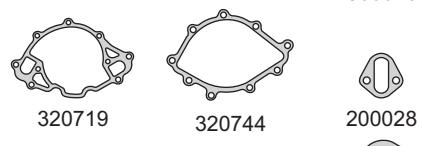
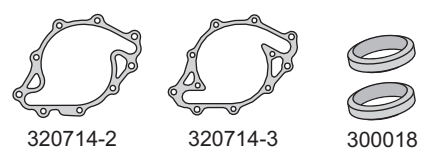
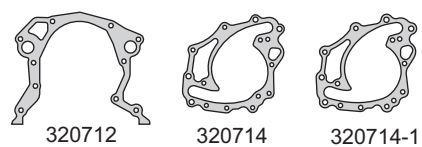

R300212N

FORD

FORD



Motor/Engine	Cm³	HP	Ø
Zetec SE 16V	1388	90/75	76

Ford: Fiesta SE - Courier - Puma 1996/...



Nº OE	Descripción/Description	Mat.	1	2	Ref.
	Jgo. de juntas para motor				320900-R
	Jgo. de juntas superior		●		320995
	Jgo. de juntas superior (MLS)				320995 MLS
	Junta tapa cilindros Ø 78 ± 1.50 N.R.	NFT	1	1	320907
	Junta tapa cilindros Ø 77 ± 1.40 N.R.	MLS			320908
1012744 97MM6051BC	Jgo. de tornillos JTC (HAT55055/HAT55100)				B320900
1072018	Junta tapa válvulas	GS	1	1	320910
1004459	Junta para cárter	NFT	1	1	320911
1004452	Frente motor	NFT	1	1	320912
1007715	Bomba de agua	SLS	1	1	320914
1072066	Múltiple escape	AC	1	1	320915
1004476	Jgo. guarnición admisión (2)	V	1	1	320917
1018250	Termostato	NB	1	1	320919
	Junta goma	N	1	1	320929
	Junta cuerpo mariposa	N	1	1	320931
	Termostato	GS	1	1	560131
	Válvula IAC	N	1	1	320933
1663816	Arandela A 15 x 21 x 2 A	AL	1	1	
	Kit de retenes completo				R320900
	Jgo. retén válvulas (16)	V	1	1	R320910V
1143317	Porta retén bancada 80 x 128 x 19.4	T			PR320911T
1004457	Retén distribución 33 x 47 x 5	V	1	1	R320912V
1077686	Retén árbol levas 38 x 52 x 6	V	2	2	R320913V

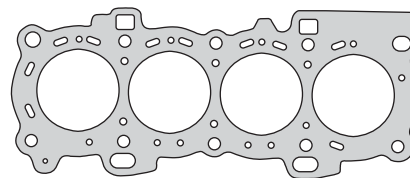

320907

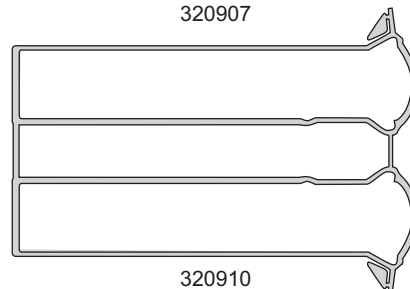

320910

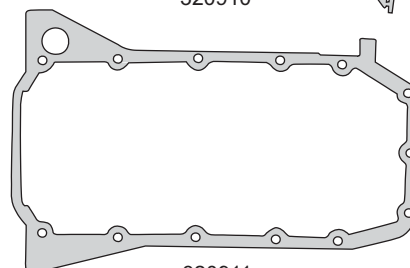

320911



320915

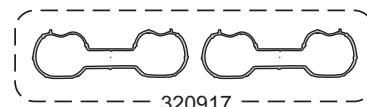

320917

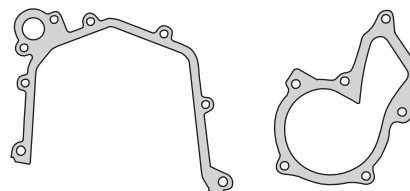

320912

320914



320919



320929



320931



560131



A 15 x 21 x 2 A



320933

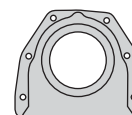

PR320911T



R320912V



R320913V

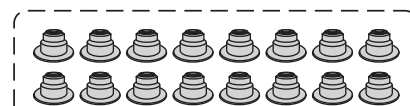

R320910V

FORD

FORD



Motor/Engine **F302L V8** Cm³ **5000** HP **101.6**

Ford: F100 - F250 - F350 - Mustang
Thunderbird - Bronco 1983/96

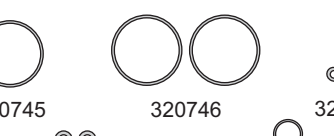
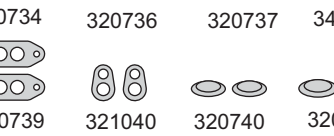
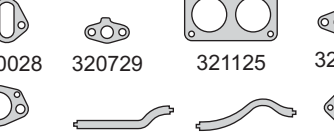
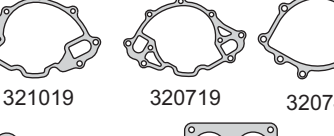
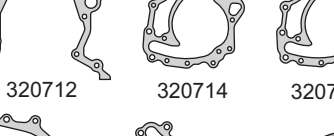
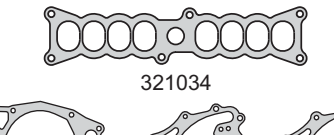
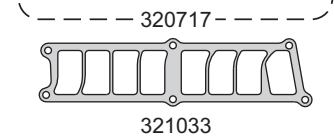
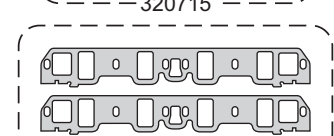
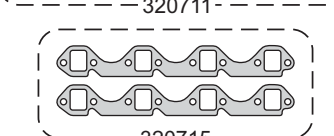
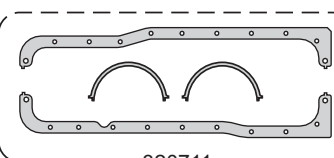
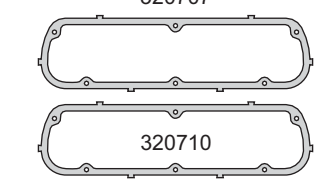
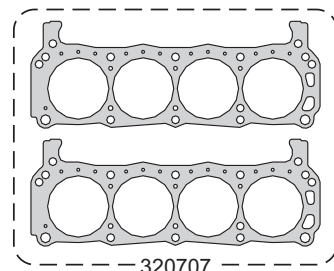

A 13 x 23 x 1.5 C G 32.9 x 2.62

Nº OE	Descripción/Description	Mat.	Ref.
	Jgo. de juntas para motor		● 321000-ET
	Jgo. jta. tapa cilin. Ø104.5 ±1.20 (2)	NFT	320705
	Jgo. jta. tapa cilin. Ø103.5 ±1.20 (2)	NFT	1 320707
	Junta tapa válvulas	CG	2 320710
	Jgo. junta para cárter (4)	CG	1 320711
	Tapa distribución	CB	1 320712
	Tapa bomba de agua	CB	1 320714
	Tapa bomba de agua	CB	1 320714-1
	Tapa bomba de agua	CB	1 321014
	Tapa bomba de agua	CB	1 321014-1
	Jgo. múltiple escape (2)	NFT	1 320715
	Jgo. múltipe admisión (2)	NFT	1 320717
	Salida de escape	FCH	2 300018
	Placa bomba de agua	CB	1 320719
	Placa bomba de agua	CB	1 321019
	Junta base carburador	CB	1 321125
	Bomba de nafta	CB	1 200028
	Chupador bomba de aceite	CB	1 320729
	Junta válvulas E.G.R	NFT	1 321030
	Entre múltiple colector	CB	1 321033
	Entre múltiple colector	NFT	1 321034
	Base termostato	CB	1 320734
	Cierre admisión delantera	CG	1 320736
	Cierre admisión trasera	CG	1 320737
	Entrada aire	CB	1 340837
	Junta E.G.R	NFT	2 320739
	Junta brida	NB	2 321040
	EGR tubo cónica 17 x 26	NFT	2 320740
	EGR tubo cónica 20 x 29	NFT	2 320741
	Acople bomba de aceite	CB	1 320744
	Filtro de aire 127 x 140	CB	1 320745
	Filtro de aire 134 x 146	CB	2 320746
	Acople bomba de aceite	CB	1 320747
	Arandela tapón cárter A 13 x 23 x 1.5 C	CU	2
	O'ring G 32.99 x 2.62	GS	1

FORD

FORD



Motor/Engine Cm³ HP Ø

F351WL V8 5800 101.6

Ford: F100 - F250 - F350 - Bronco 1985/95



Nº OE	Descripción/Description	Mat.	Ref.
	Jgo. de juntas para motor	●	321100-ET
	Jgo. de juntas para motor		321101-ET
	Jgo. jta. tapa cilindros Ø 104.5 ± 1.20 (2)	NFT	320705
	Jgo. jta. tapa cilin. Ø103.5 ± 1.20 (2)	NFT	1 320707
	Junta tapa válvulas	CG	2 320710
	Jgo. junta para cárter (3)	CG	1 321111
	Tapa distribución	CB	1 320712
	Placa distribución	CB	1 321113
	Tapa bomba de agua	CB	1 320714
	Tapa bomba de agua	CB	1 320714-1
	Tapa bomba de agua	CB	1 321114
	Jgo. múltiple escape (2)	NFT	1 320715
	Jgo. múltiple admisión (2)	NFT	1 320717
	Salida de escape	FCH	2 300018
	Placa bomba de agua	CB	1 321119
	Placa bomba de agua	CB	1 320719
	Base carburador	CB	1 321125
	Bomba de nafta	CB	1 200028
	Chupador bomba de aceite	CB	1 320729
	Junta brida	CB	1 321129
	Junta	NFT	1 321230
	Cierre admisión delantera	CG	1 321130
	Cierre admisión trasera	CG	1 321131
	Entre colector admisión	CB	1 321134
	Base termostato	CB	1 320734
	Junta brida	NB	1 321137
	Junta entrada de aire	CB	1 340637
	EGR válvula	NFT	2 320739
	EGR tubo cónica 17 x 26	NFT	2 320740
	EGR tubo cónica 20 x 29	NFT	2 320741
	Acople bomba de aceite	CB	1 320744
	Filtro de aire 127 x 140	CB	1 320745
	Filtro de aire 134 x 146	CB	2 320746
	Arandela tapon cárter A 13 x 23 x 1.5 C	CU	2
	O´ring G 32.99 x 2.62	GS	1

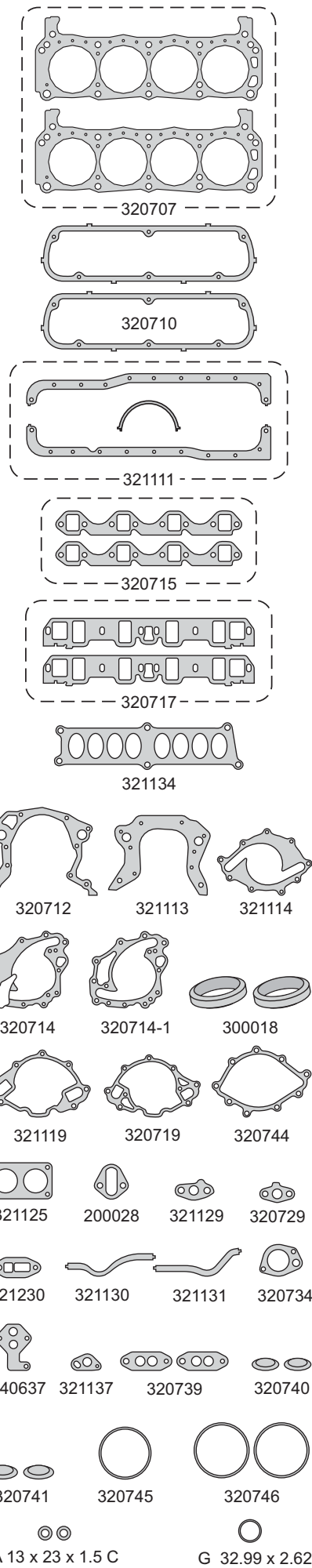

FORD

FORD



Motor/Engine **F351W V8** Cm³ **5000** HP **101.6**

Ford: F250 - F350 - Mustang

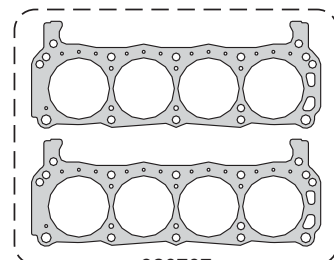

320707

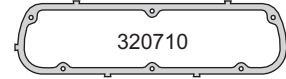
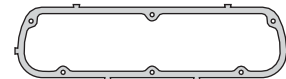

320710

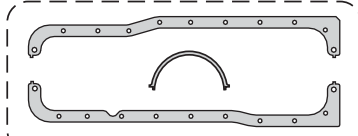

321111

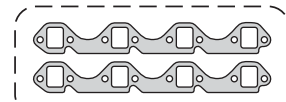

320715

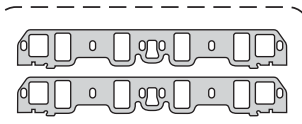

320717

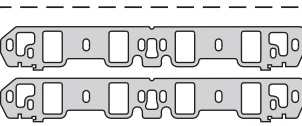

321217

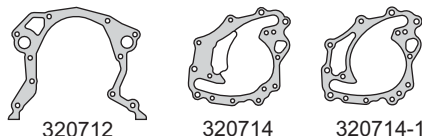

320712

320714

320714-1



320714-3

320719

320744

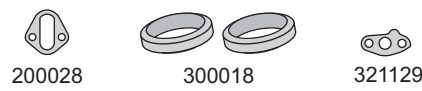

200028

300018

321129



320729

321230

320734

321130

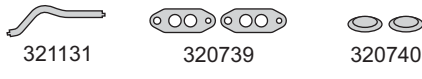

321131

320739

320740



320741

320745

320747

320746



A 13 x 23 x 1.5 C

G 32.9 x 2.62



R300212N

Nº OE	Descripción/Description	Mat.	Ref.
	Jgo. de juntas para motor		● 321200-R-ET
	Jgo. jta. tapa cilindros Ø 104.5 ± 1.20 (2)	NFT	320705
	Jgo. jta. tapa cil. Ø 103.5 ± 1.20 (2)	NFT	1 320707
	Junta tapa válvulas	CG	2 320710
	Jgo. junta para cárter (3)	CG	1 321111
	Tapa distribución	CB	1 320712
	Tapa bomba de agua	CB	1 320714
	Tapa bomba de agua	CB	1 320714-1
	Tapa bomba de agua	CB	320714-3
	Jgo. múltiple escape (2)	NFT	1 320715
	Jgo. múltipe admisión (2)	NFT	1 320717
	Jgo. múltipe admisión (2)	NFT	1 321217
	Salida de escape	FCH	2 300018
	Placa bomba de agua	CB	1 320719
	Bomba de nafta	CB	1 200028
	Chupador bomba de aceite	CB	1 320729
	Junta brida	CB	1 321129
	Junta brida	NFT	1 321230
	Base termostato	CB	1 320734
	Cierre admisión delantera	CG	1 321130
	Cierre admisión trasera	CG	1 321131
	EGR válvula	NFT	2 320739
	EGR tubo cónica 17 x 26	NFT	2 320740
	EGR tubo cónica 20 x 29	NFT	2 320741
	Acople bomba de aceite	CB	1 320744
	Acople bomba de aceite	CB	1 320747
	Filtro de aire 127 x 140	CB	1 320745
	Filtro de aire 134 x 146	CB	1 320746
	Arandela tapon cárter A 13 x 23 x 1.5 C	N	2
	O´ring G 32.99 x 2.62	GS	1
	Retén distribución 47.65 x 65.05 x 12	N	1 R300212N

FORD

FORD



Motor/Engine Cm³ HP Ø

ZETEC (DOHC) 16V 1796 115 80.6

Ford: Mondeo 1993/...



Nº OE	Descripción/Description	Mat.		Ref.
	Jgo. de juntas para motor		●	321300-R
	Jgo. de juntas superior	●	●	321395
7114447	Jta. tapa cilindros Ø 81.7 \pm 1.60 N.R.	NFT	1	320307
	Jgo. de tornillos JTC (HAT55055/HAT55100)			B320300
1663394	Conj. junta tapa válvulas (11)	GS	1	320310
7008824	Junta para cárter	N	1	320311
7378788	Frente bomba aceite	CB	1	320312
6691888	Bomba de agua	CB	1	320314
7181761	Múltiple escape	AC	1	320315
6669767	Junta aislante admisión	AL/N	1	321517
	Entre placa admisión	CB	1	320329
	Junta caja termostato	CB	1	320332
	Junta	SLS	1	340833
1663908	Chupador aceite	CB	1	320334
7090340	Mariposa gases	CB	1	320335
1663861	Bancada trasera	CB	1	320336
6759630	Anillo tapa válvulas G 8.5 x 13.4 x 5	GS	10	320337
6692744	Acople caño de escape			320048
	Arandela cárter A 15 x 21 x 2 A	AL	1	
	Kit de retenes completo			R320300
	Jgo. retén válvulas (16)	V	1	R320310V
	Retén bancada 88 x 108 x 10	V	1	R320311V
	Retén distribución 35 x 50 x 7	V	1	R470013V
	Retén árbol levas 42 x 53 x 7	V	2	R320313V

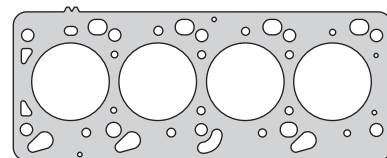

320307

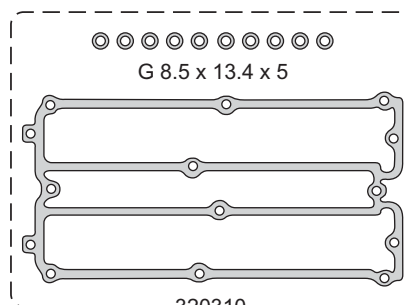

320310

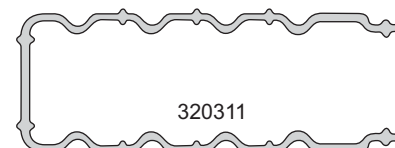

320311



320315

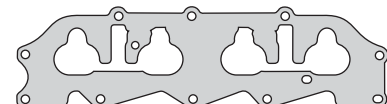

321517

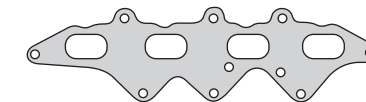

320329

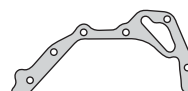

320312



320336



320314



320332



340833



320334



A 15 x 21 x 2A



320335



R320311V



R470013V



R320313V



R320310V

FORD

FORD



Motor/Engine **Cm³** **HP** **Ø**
ZETEC
 (DOHC) 16V

Ford: Mondeo 1993/01



Nº OE	Descripción/Description	Mat.			Ref.
	Jgo. de juntas para motor				321500-R
	Jgo. de juntas superior		●	●	321595
7114447	Junta tapa cilindros Ø 87 \pm 1.70	NFT	1	1	320507
	Jgo. de tornillos JTC (HAT55055/HAT55100)				B320300
1663394	Conj. junta tapa válvulas (11)	GS	1	1	320310
7008824	Junta para cárter	N		1	320311
7378788	Frente bomba aceite	CB		1	320312
6691888	Bomba de agua	CB		1	320314
7181761	Múltiple escape	AC	1	1	320315
6669767	Jgo. junta aislante admisión	AL/N	1	1	321517
1048093	Jgo. juntas múltiple admisión 1997/... (4)	N		1	320517
1663383	Múltiple admisión	CB		1	320329
	Junta caja termostato	CB		1	320332
	Junta	SLS	1		340833
1663908	Chupador aceite	CB		1	320334
7090340	Mariposa gases	CB		1	320335
1663861	Bancada trasera	CB		1	320336
6759630	Anillo tapa válvulas G 8.5 x 13.4 x 5	GS	10	10	320337
6692744	Acople caño de escape				320048
	Arandela cárter A 15 x 21 x 2 A	AL		1	
	Kit de retenes completo				R320300
	Jgo. retén válvulas (16)	V		1	R320310V
	Retén bancada 88 x 108 x 10	V		1	R320311V
	Retén distribución 35 x 50 x 7	V		1	R470013V
	Retén árbol levas 42 x 53 x 7	V		2	R320313V

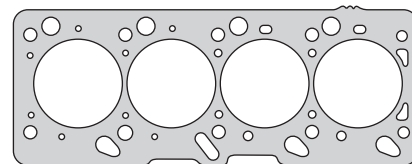

320507

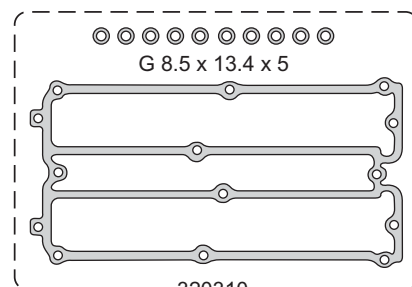

G 8.5 x 13.4 x 5

320310

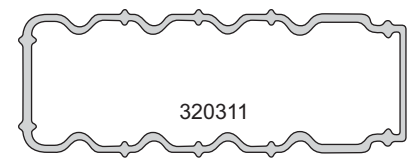

320311



320315

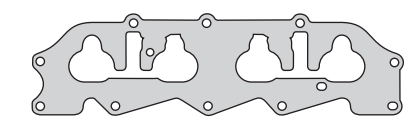

321517

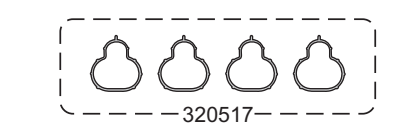

320517

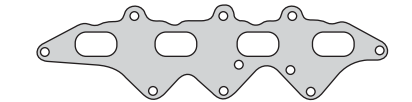

320329

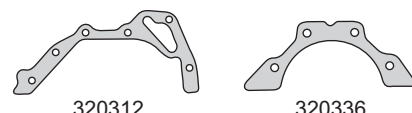

320312

320336

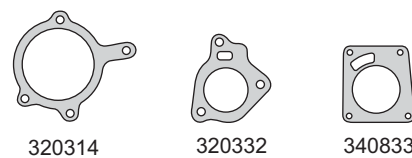

320314

320332

340833

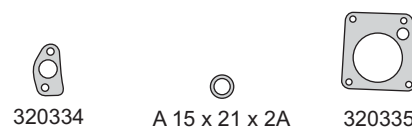

320334

A 15 x 21 x 2 A

320335

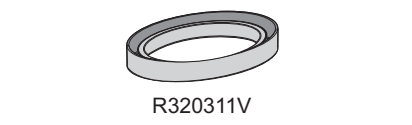

R320311V



R470013V

R320313V

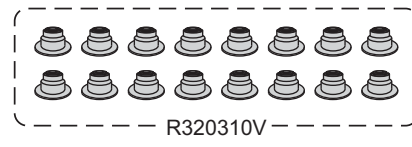

R320310V

FORD

FORD



Motor/Engine	Cm³	HP	Ø
L4 Sigma	1596	74	79
HWDA/HWDB	1596	100	79
FYJA	1596	100	79
B4164S3 (DOHC) 16V	1596	101	79

Ford: Fiesta - Fusión 2003/... - Focus 2004/...
C-Max 2007/...
Volvo: C30 - S40 - V50 2005/...



Nº OE	Descripción/Description	Mat.	Ref.
	Jgo. de juntas para motor		321600-R MLS
	Jgo. de juntas superior (MLS)		321695 MLS
7S7G6051CB	Junta tapa cilindros Ø 80 \pm 0.30 N.R.	MLS 1 1	321608
	Jgo. de tornillos JTC (HAT55055/HAT55100)		B320900
	Sellador líquido - caucho de silicona		TRN0280R
1S6G6K260AA	Junta tapa válvulas	GS 1 1	321610
1004459	Junta para cárter	NFT 1	320911
BM5G6659BA	Junta distribución	SLS	321612
1004452	Frente motor	NFT 1	320912
BE8Z8507A	Bomba de agua	SLS 1	320914
844524J2WP	Múltiple escape	SLS 1 1	321615
4M5G9441FA	Jgo. múltiple admisión (4)	1 1	321617
2S619451AC	Salida de escape	AC 1	321618
7M5Z8255A	Bomba de agua	GS 1	321619
BE8Z8255A	Termostato	N 1	320929
BE8Z8255Z	Válvula IAC	GS 1	560131
4M5G9P84BCA	Guarnición	GS 1 1	321632
AM4S6G9186AA	O´ring Inyector G 7.52 x 3.53	V 4 4	
	Kit de retenes completo		R320900
	Jgo. retén válvulas (16)	V 1	R320910V
BM5Z6K301B	Porta retén bancada 80 x 128 x 19.4	T	PR320911T
	Retén distribución 33 x 47 x 5	V 1	R320912V
6M5G6K292BA	Retén árbol levas 38 x 52 x 6	V 2	R320913V

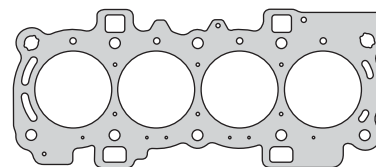

321608

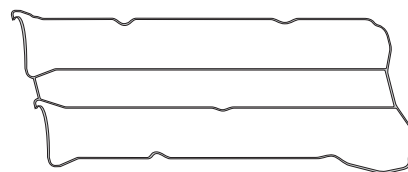

321610

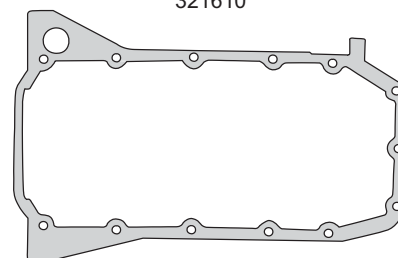

320911



321615

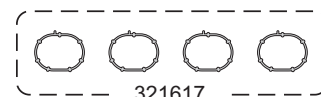

321617

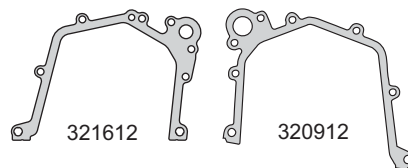

321612

320912



321618

320914

321619



320929

560131

321632

00000
G 7.52 x 3.53

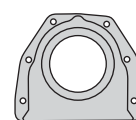

PR320911T



R320912V

R320913V



R320910V

FORD

FORD



Motor/Engine	Cm³	HP	Ø
260 V8	4300		96
289 V8	4800		96
302 V8	5000		96

Ford: Galaxy 500 - Fairlane - Falcon - Maverich
Mustang - Grand Marquis - F150 - F250
1965/84



Nº OE	Descripción/Description	Mat.	Ref.
	Jgo. de juntas para motor		● 321800-RMX
	Jgo. de juntas superior	●	321895
	Jgo. junta tapa cilindros Ø 104 \pm 1.40 (2)	NFT 1	1 310105
	Junta tapa de válvulas	CG 2	2 320710
	Jgo. junta para cárter (4)	CG 1	1 320711
	Puntera para cárter	CG 1	1 320711/4
	Puntera para cárter	CG 1	1 320711/5
	Jgo. frente distribución (9)	VS 1	1 320712MX
	Tapa distribución	CB 1	1 320712
	Tapa bomba de agua	CB 1	1 320714
	Placa bomba de agua	CB 1	1 320714/2
	Placa bomba de agua	CB 1	1 320714/3
	Jgo. múltiple escape (2)	NFT 1	1 320715
	Salida de escape	FCH 2	2 300018
	Placa bomba de agua	CB 1	1 320719
	Junta motor	NB 1	1 320720
	Bomba de nafta	CB 1	1 200028
	Chupador bomba de aceite	CB 1	1 320729
	Base termostato	CB 1	1 320734
	Cierre admisión delantera	CG 1	1 320736
	Cierre admisión trasera	CG 1	1 320737
	Acople bomba de aceite	CB 1	1 320747
	Juntas sobre admisión	NFT 2	2 320748
	Jgo. de juntas sobreadmisión (4)	VS 1	1 320748MX
	Junta brida	CB 1	1 320761
	Junta motor	NFT 2	2 320762
	Arandela A 14 x 18 x 1.5 A	AL 1	1
	Kit de retenes completo		R321800
	Jgo. retén válvulas (16)	P 1	1 R320710P
	Retén bancada 92 x 106 x 5	P 1	1 R321811P
	Retén distribución 48 x 65 x 7.85	N 1	1 R320712N

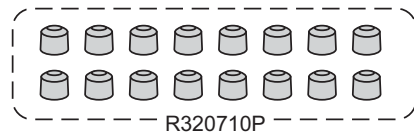
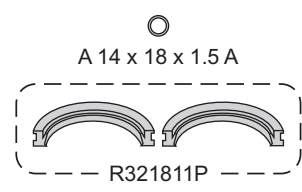
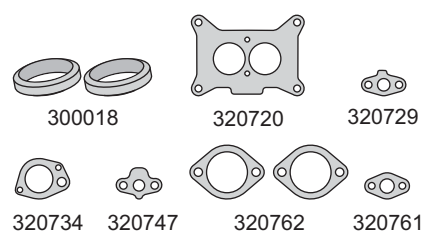
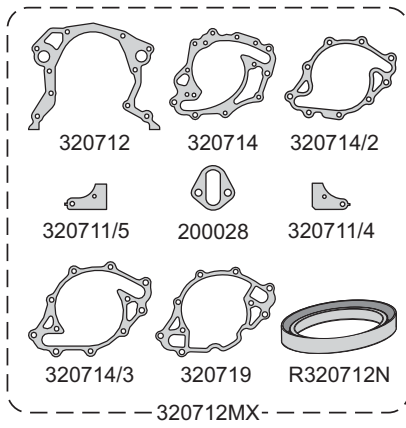
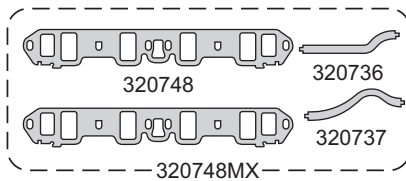
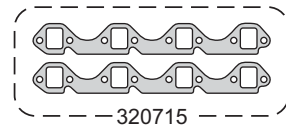
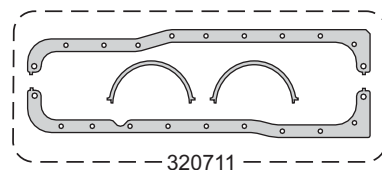
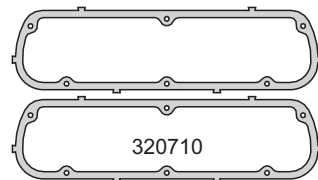
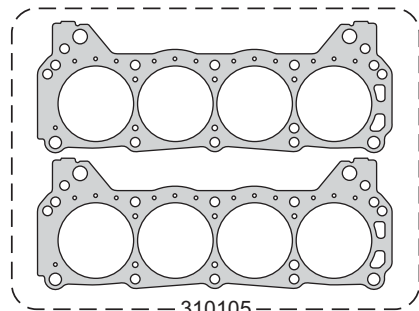

FORD

FORD



Motor/Engine **Cm³** **HP** **Ø**
302 V8 **5000** **96**

Ford: Cougar - Thunderbird - F200 - F350
 1991/95



Nº OE	Descripción/Description	Mat.			Ref.
	Jgo. de juntas para motor				321900-RMX
	Jgo. de juntas superior	●			321995
	Jgo. tapa cil. Ø 104.5 ± 1.20 (2)	NFT	1	1	320705
	Jgo. tapa cil. Ø 103.5 ± 1.20 (2)	NFT			320707
	Junta tapa de válvulas	CG	2	2	320710
	Jgo. junta para cárter (4)	CG		1	320711
	Tapa distribución	CB		1	320712
	Bomba de agua	CB		1	320214
	Tapa bomba de agua	CB		1	321014
	Tapa bomba de agua	CB		1	321014-1
	Jgo. múltiple escape (2)	NFT	1	1	320715
	Jgo. múltiple admisión (6)	NFT	1	1	320717-1
	Junta termostato	CB		1	321019
	Placa bomba de agua	CB		1	320719
	Bomba de nafta	CB		1	200028
	Chupador bomba de aceite	CB		1	320729
	Junta cierre admisión delantera	CG	1	1	321130
	Junta cierre admisión trasera	CG	1	1	321131
	Entre múltiple colector	CB	1	1	301033
	Entre múltiple colector	NFT	1	1	301034
	Base termostato	CB	1	1	320734
	Junta motor	NFT		1	340635
	Cierre admisión delantera	CG	1	1	320736
	Cierre admisión trasera	CG	1	1	320737
	Junta EGR	NFT	1	1	320739
	Arandela A 14 x 18 x 1.5 A	AL		1	
	O´ring G 31.42 x 2.62	GS		1	
	Kit de retenes completo				R321900
	Jgo. retén válvulas (16)	P		1	R340510P
	Retén bancada 92 x 108 x 9.8	P		1	R300311P
	Retén distribución 48 x 65 x 7.85	N		1	R320712N

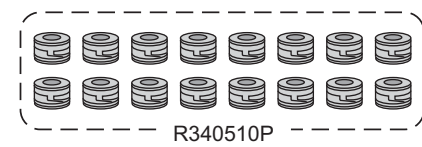
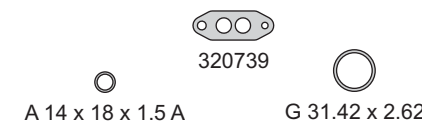
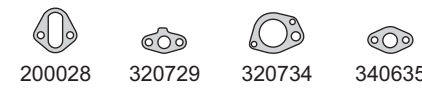
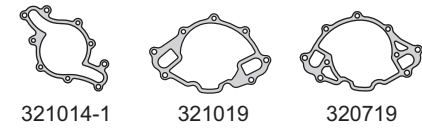
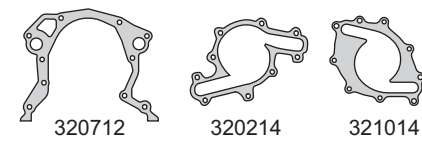
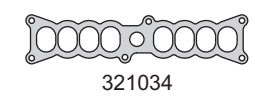
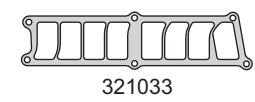
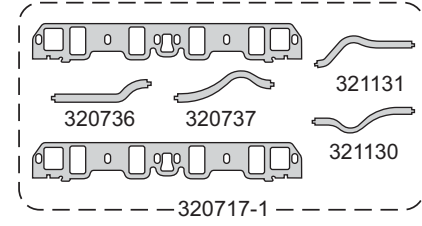
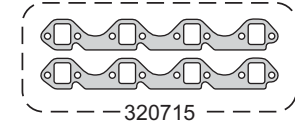
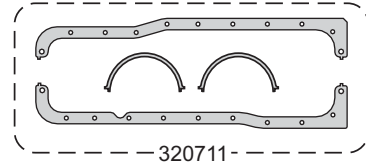
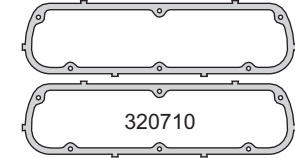
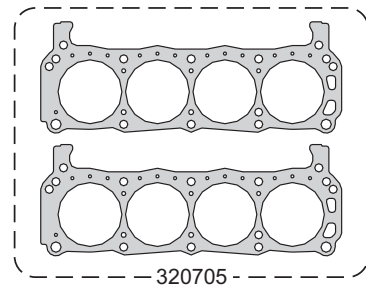

FORD

FORD



Motor/Engine	Cm³	HP	Ø
335 V8	5500		101.6
351 V8	5800		101.6

Ford: F250 - F350 - F600 - Microbus (Chasis) 1984/91



Nº OE	Descripción/Description	Mat.	Ref.
	Jgo. de juntas para motor		322000-RMX
	Jgo. de juntas superior	●	322095
	Jgo. tapa cil. Ø 104.5 ± 1.20 (2)	NFT 1 1	320705
	Jgo. tapa cil. Ø 103.5 ± 1.20 (2) N.R.?	NFT	320707
	Junta tapa de válvulas	CG 2 2	320710
	Jgo. junta para cárter (4)	CG 1 1	321111
	Tapa distribución	CB 1 1	320712
	Jgo. múltiple escape (2)	NFT 1 1	320715
	Jgo. junta sobre admisión (4)	VS 1 1	322017
	Salida de escape	FCH 2 2	300018
	Placa bomba de agua	CB 1 1	320719
	Junta	NB 1 1	320720
	Bomba de nafta	CB 1 1	200028
	Junta brida	CB 1 1	321129
	Junta cierre admisión delantera	CG 1 1	321130
	Junta cierre admisión trasera	CG 1 1	301131
	Entre múltiple colector	CB 1 1	321033
	Entre múltiple colector	NFT 1 1	321034
	Base termostato	CB 1 1	320734
	Junta sobre admisión	NFT 2 2	320748
	Junta brida	CB 1 1	320761
	O´ring G 7.52 x 3.53	GS 16 16	
	Arandela A 14 x 18 x 1.5 A	AL	1
	Kit de retenes completo (16)		R322000
	Jgo. retén válvulas (16)	P 1 1	R320710P
	Retén bancada 95 x 114.5 x 9.5	P 1 1	R340911P
	Retén distribución 48 x 65 x 7.85	N 1 1	R320712N

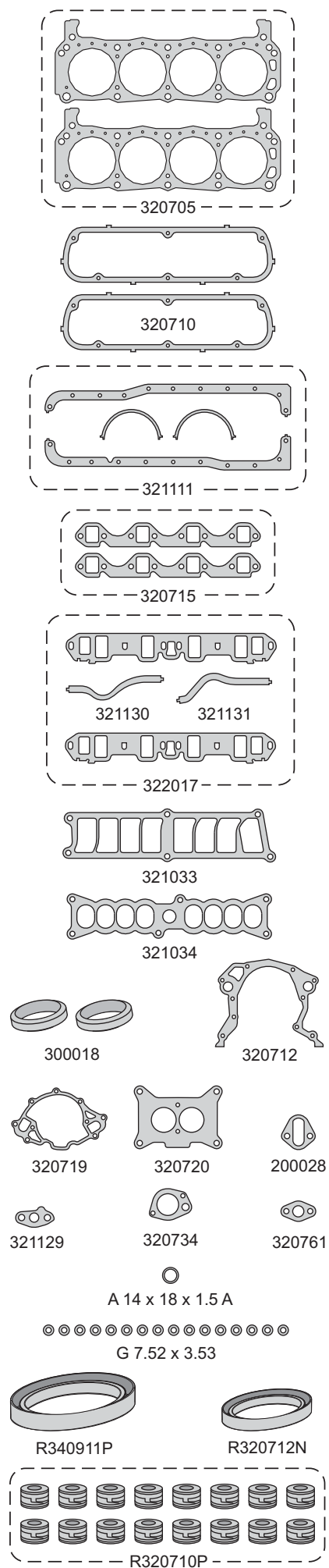

FORD

FORD



Motor/Engine **351 V8** **5000** **HP** **101.6** **Ø**

Ford: Grand Marquis - Galaxy - Camiones
F250 - Mustang - F350 - FB 600 1969/84



Nº OE	Descripción/Description	Mat.			Ref.
	Jgo. de juntas para motor				322100-RMX
	Jgo. de juntas superior		●		322195
	Jgo. junta tapa cilin. Ø 104.5 ± 1.20 (2)	NFT	1	1	320705
	Jgo. tapa cil. Ø 103.5 ± 1.20 (2)	NFT			320707
	Junta tapa válvulas	CG	2	2	320710
	Jgo. junta para cárter (4)	CG		1	322111
	Tapa distribución	CB		1	320712
	Jgo. múltiple escape (2)	NFT	1	1	322116
	Jgo. junta sobre admisión (4)	VS	1	1	322017
	Salida de escape	FCH		2	300018
	Placa bomba de agua	CB		1	320719
	Junta	NB		1	320720
	Bomba de nafta	CB		1	200028
	Junta	CB		1	321129
	Junta	CG	1	1	321130
	Junta	CG	1	1	321131
	Base termostato	CB		1	320734
	Juntas sobreadmisión	NFT	2	2	320748
	Junta	CB		1	320761
	Arandela A 14 x 18 x 1.5 A	AL		1	
	Kit de retenes completo				R322100
	Jgo. retén válvulas (16)	P		1	R320710P
	Retén bancada 96 x 110 x 5.5	P		1	R322111P
	Retén distribución 48 x 65 x 7.9	N		1	R320712N

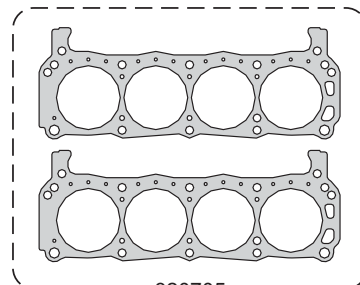

320705

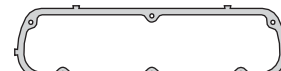

320710

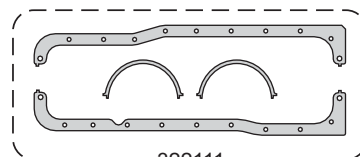

322111



322116

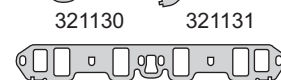
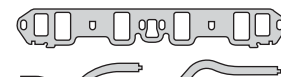

321130 321131

322017



320712



320719



300018

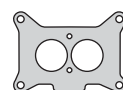

320720



200028



321129



320734

A 14 x 18 x 1.5 A

320761



R321111P



R320712N

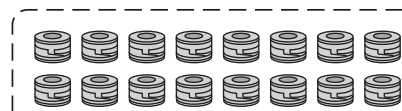

R320710P

FORD



Motor/Engine	Cm³	HP	Ø
110	1800	104	78
121	1900	104	78
123	2000	104	80

Ford: Courier 1972/82



Nº OE	Descripción/Description	Mat.	Ref.
	Jgo. de juntas para motor		322200-RMX
	Junta tapa de cilindros Ø 82 ± 1.20		1 322205
	Jgo. junta tapa válvulas (3)		CG 1 322210
	Junta para cárter		CG 1 970311
	Tapa distribución		NB 1 970312
	Tapa distribución		NB 1 970313
	Bomba de agua		CB 1 322214
	Bomba de agua		CB 1 970314
	Jgo. múltiple escape (4)		NFT 1 322216
	Jgo. múltiple escape (2)		NFT 1 970316
	Múltiple admisión		NB 1 970317
	Salida de escape		NFT 1 970318
	Junta		NB 2 322220
	Junta		NB 2 322221
	Base bomba aceite		NB 1 970327
	Junta		NB 1 322231
	Junta		NB 1 322232
	Junta		NB 1 970332
	Junta		CG 1 322233
	Junta		NFT 1 322234
	Junta		NFT 1 322235
	Junta		NFT 1 322237
	Junta		CG 1 322238
	Junta		NB 1 322239
	Junta		NB 1 322240
	Junta		NB 1 322241
	Junta		GS 2 322242
	Arandela A 18 x 22 x 1.5 A		AL 1
	O´ring G 9.25 x 1.78		GS 1
	O´ring G 21.95 x 1.78		GS 1
	O´ring G 15.54 x 2.62		GS 1
	O´ring G 25.07 x 2.62		GS 1
	O´ring G 29.74 x 3.53		GS 1
	O´ring G 53.57 x 3.53		GS 1
	Kit de retenes completo		R322200
	Jgo. retén válvulas (8)		P 1 R322210P
	Retén bancada 80 x 105 x 13		P 1 R970311P
	Retén distribución 48 x 70 x 9		P 1 R900012P

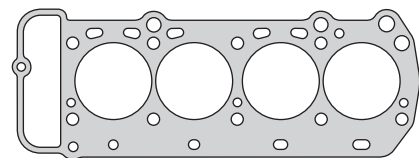

322205

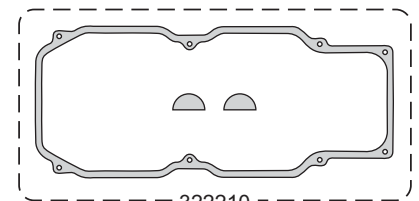

322210

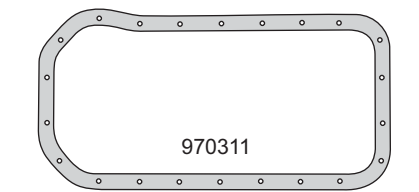

970311

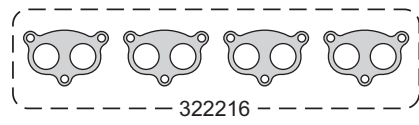

322216

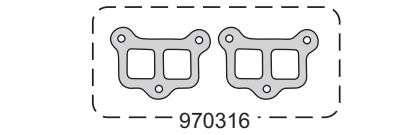

970316

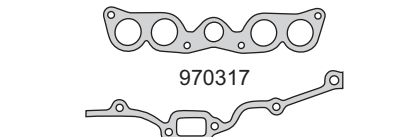

970317

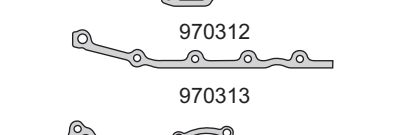

970312



970314

322214

970318

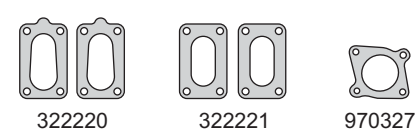

322220

322221

970327

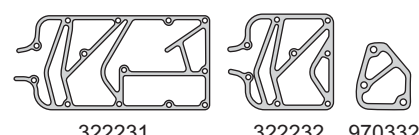

322231

322232

970332



322233

322234

322235

322237

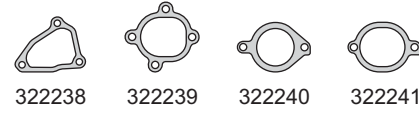

322238

322239

322240

322241

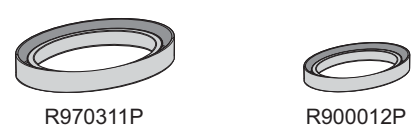

R970311P

R900012P

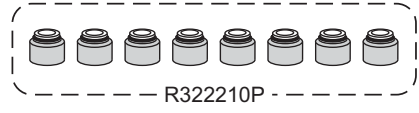

R322210P

FORD

FORD



Motor/Engine	Cm³	HP	Ø
232 V6	3797	140/205	97

Ford: Thunderbird - Cougar Super Cargado
Taurus - Sable 1988/93



Nº OE	Descripción/Description	Mat.	Ref.
	Jgo. de juntas para motor		322300-RMX
	Jgo. de juntas superior	●	322395
	Jgo. jta. tapa cil. Ø 99 \pm 1.30 (2)	NFT 1	322307
	Junta tapa valvulas	GS 2	320210
	Jgo. junta para cárter (2)	CG 1	320211
	Tapa distribución	CB 1	320212
	Tapa bomba de agua	CB 1	320214
	Jgo. múltiple escape (2)	NFT 1	320215
	Jgo. multiple admisión (2)	NFT 1	320216
	Junta succión aceite	NFT 1	310927
	Junta	NFT 1	322330
	Junta cierre admisión delantera	CG 1	320231
	Junta	CB 1	322331
	Junta cierre admisión trasera	CG 1	320232
	Junta	CB 1	322332
	Junta entrada aire	CB 1	310936
	Arandela A 16 x 19 x 1 C	CU 1	
	O'ring G 29.2 x 1.78	GS 1	
	O'ring G 28.24 x 2.62	GS 2	
	O'ring G 71.12 x 2.62	GS 1	
	O'ring G 7.52 x 3.53	GS 6	
	O'ring G 34.52 x 3.53	GS 1	
	Kit de retenes completo		R322300
	Jgo. retén válvulas (12)	P 1	R322310P
	Retén bancada 92 x 108 x 9.8	P 1	R300311P
	Retén distribución 47 x 65/80 x 15	P 1	R340412P

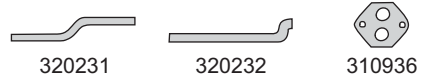
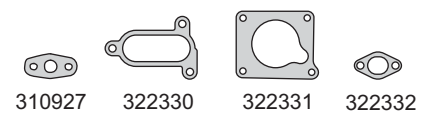
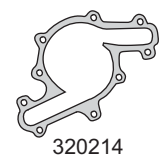
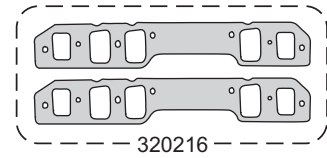
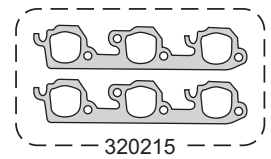
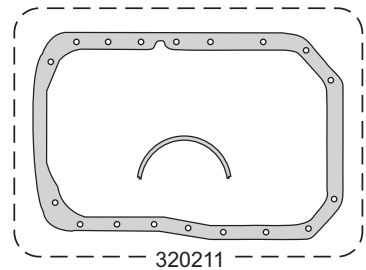
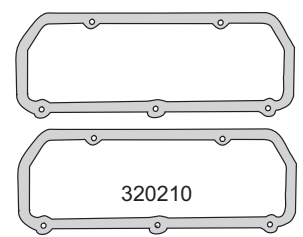
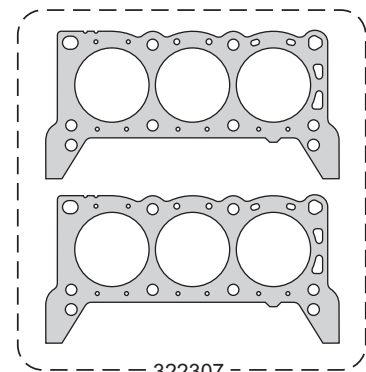

A 16 x 19 x 1 C



FORD

FORD



Motor/Engine Cm³ HP Ø

171 V6 2792 160 93

Ford: Bronco - Grandada - Capri 1983/86



Nº OE	Descripción/Description	Mat.	Ref.
	Jgo. de juntas para motor		● 322400-RMX
	Jgo. junta tapa cilindros Ø 95 \pm 1.30 (2)	NFT	1 322405
	Conj. junta tapa válvulas (2)	CG	1 322410
	Jgo. junta para cárter (7)	CG	1 322411
	Tapa distribución	CB	1 322412
	Tapa distribución	CB	1 322413
	Bomba de agua	CB	1 322414-1
	Bomba de agua	CB	1 322414-2
	Jgo. múltiple escape (2)	NFT	1 322416
	Múltiple admisión	NFT	1 322417
	Junta	CB	1 322430
	Junta	NB	1 322431
	Junta	NB	1 322432
	Junta	CB	1 322433
	Junta	CB	1 322434
	Junta	NFT	1 322435
	Junta	NB	1 322436
	O´ring G 23.39 x 3.53	GS	1
	O´ring G 47.22 x 3.53	GS	1
	Anillo G 24 x 30 x 3.9	GS	1
	Anillo G 42 x 57 x 3	GS	1
	Kit de retenes completo		R322400
	Jgo. retén válvulas (12)	P	1 R322410P
	Retén bancada 60.45 x 76.18 x 10	V	1 R320111V
	Retén distribución 42 x 56 x 7	P	1 R300612P

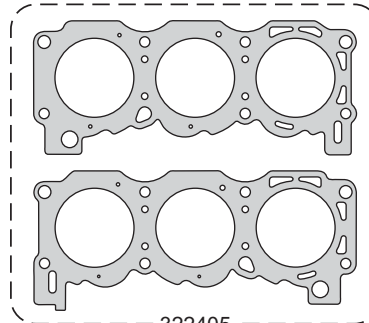

322405

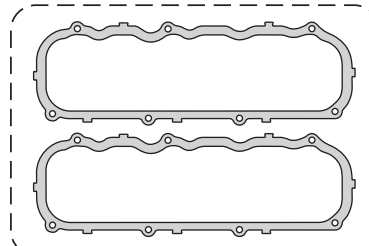

322410

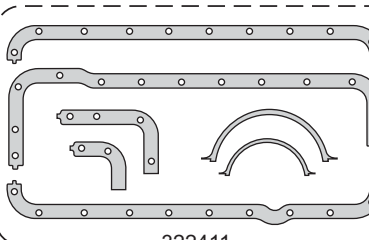

322411

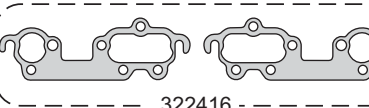

322416

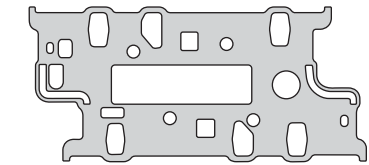

322417

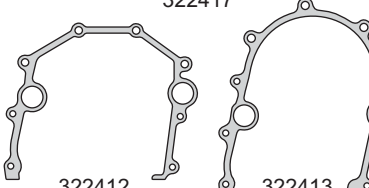

322412

322413

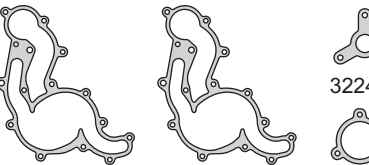

322414-1

322414-2

322430

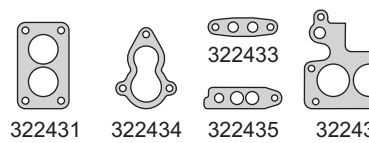

322431

322434

322433

322435

322436

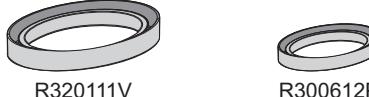

R320111V

R300612P

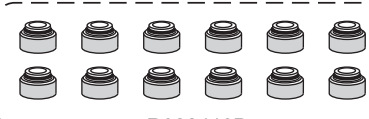

R322410P

FORD

FORD



Motor/Engine	Cm³	HP	Ø
Triton 281 V8	4600	180	90
Triton 330 V8	5408	260	90

Ford: E-Series - F-Series - Expedition
Triton1997/99
(incluye junta múltiple de admisión con ventana de gota)

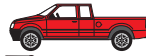

Nº OE	Descripción/Description	Mat.		Ref.
	Jgo. de juntas para motor		●	322500-R
	Jgo. de juntas superior		●	322595
	Jgo. jta. tapa cil. Ø 93 ± 1.30 (2) N.R.	NFT		340707
	Jgo. jta. tapa cil. Ø 92 ± 0.88 (2) N.R.	MLS	1 1	340708
	Jgo. de tornillos JTC (HAT55055/HAT55100)			B322500
	Junta tapa de válvulas	GS	1 1	322510-1
	Junta tapa de válvulas	GS	1 1	322510-2
	Junta para cárter	PLAST	1	340711
	Jgo. cierre distribución (3)	GS	1	340712
	Jgo. múltiple escape (2)	NFT	1 1	340715
	Jgo. múltiple adm. c/perno guía superior (2)	PLAST	1 1	322517
	Base bomba aceite	PLAST	1	340727
	Base bomba aceite	PLAST	1	302627
	Junta varilla aceite	NFT	1 1	340731
	Junta	CB	1 1	302632
	Cuerpo válvula reguladora	GFT	1	340732
	Junta pleno admisión	PLAST	1 1	302732
	Junta	CB	1 1	302634
	Entrada aire	CB	1 1	340837
	O´ring G 101.19 x 3.53	GS	1	
	O´ring G 50.39 x 3.53	GS	1	
	O´ring G 20.3 x 2.62	GS	1 1	
	O´ring G 7.52 x 3.53	GS	16 16	
	Kit de retenes completo			R322500
	Jgo. retén válvulas (16)	P	1	R302510P
	Retén bancada 92 x 108 x 9.8	P	1	R300311P
	Retén distribución 47 x 63.4 x 8.8	P	1	R340712P

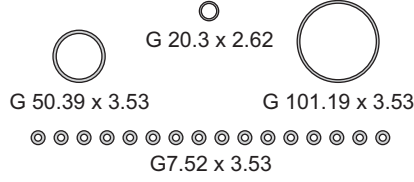
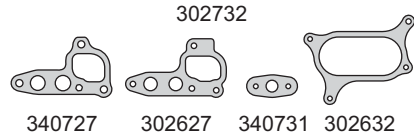
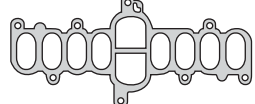
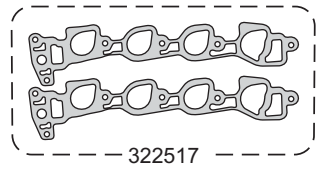
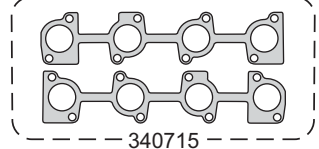
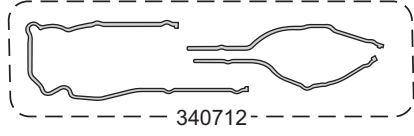
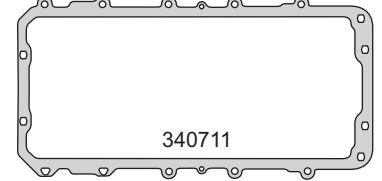
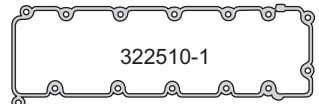
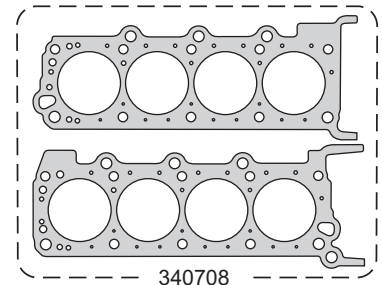

FORD

FORD



Motor/Engine	Cm³	HP	Ø
Triton 281 V8	4600	180	90
Triton 330 V8	5408	260	90

Ford: Triton 2000/03 - E-Series - F-Series Expedition
(incluye junta múltiple admisión con ventana cuadrada)



Nº OE	Descripción/Description	Mat.	Ref.
	Jgo. de juntas para motor		322600-R
	Jgo. de junta superior	●	322695
	Jgo. jta. tapa cil. Ø 93 ± 1.30 (2)	NFT	340707
	Jgo. jta. tapa cil. Ø 92 ± 0.88 (2)	MLS 1 1	340708
	Jgo. de tornillos para tapa de cilindros		B322500
	Junta tapa de válvulas	GS 1 1	322510-1
	Junta tapa de válvulas	GS 1 1	322510-2
	Junta para cárter	PLAST 1	340711
	Jgo. cierre distribución (3)	GS 1	340712
	Jgo. múltiple escape (2)	NFT 1 1	340715
	Jgo. múltiple admisión (2)	PLAST 1 1	322617
	Base bomba aceite	PLAST 1	340727
	Base bomba aceite	PLAST 1	302627
	Junta varilla aceite	NFT 1 1	340731
	Junta	CB 1 1	302632
	Cuerpo válvula reguladora	GFT 1	340732
	Junta pleno admisión	PLAST 1 1	302732
	Junta	CB 1 1	302634
	Entrada aire	CB 1 1	340837
	O´ring G 101.19 x 3.53	GS 1	
	O´ring G 50.39 x 3.53	GS 1 1	
	O´ring G 20.3 x 2.62	GS 1	
	O´ring G 7.52 x 3.53	GS 16 16	
	Kit de retenes completo		R322500
	Jgo. retén válvulas (16)	P 1	R302510P
	Retén bancada 92 x 108 x 9.8	P 1	R300311P
	Retén distribución 47 x 63.4 x 8.8	P 1	R340712P

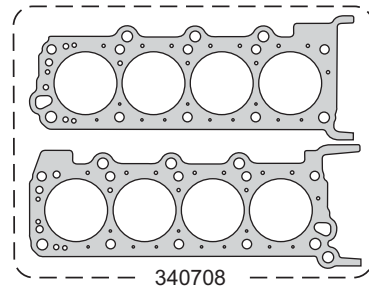

340708

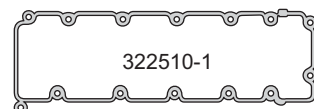

322510-1

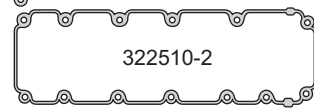

322510-2

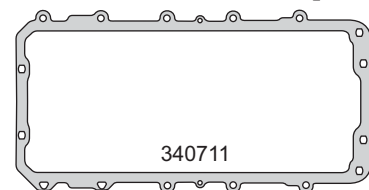

340711

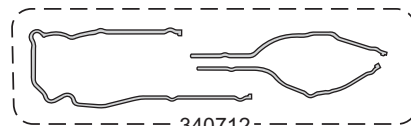

340712

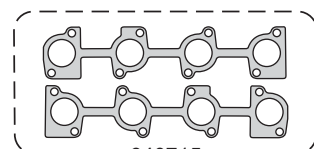

340715

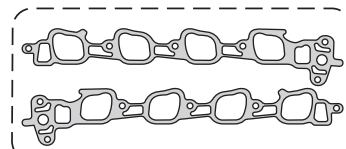

322617

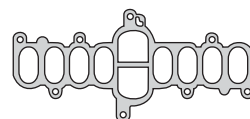

302732

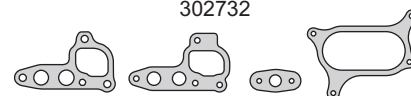

340727 302627 340731 302632



340732 340837 302634

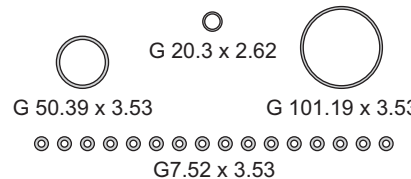

G 20.3 x 2.62
G 50.39 x 3.53 G 101.19 x 3.53
G 7.52 x 3.53



R300311P R340712P

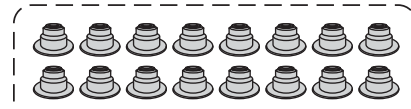

R302510P

FORD

FORD



Motor/Engine	Cm³	HP	Ø
Triton V10	6760	310	90

Ford: Triton F-450 1997/99 - Excursion
E-Series - F-Series Super Duty
(incluye junta múltiple de admisión con ventana de gota)



Nº OE	Descripción/Description	Mat.	Ref.
	Jgo. de juntas para motor		322700-R
	Jgo. junta tapa cilin. Ø 92 ± 0.88 (2)	MLS	1 322708
	Junta para cárter	PLAST	1 322711
	Jgo. cierre distribución (3)	PLAST	1 340712
	Jgo. múltiple escape (4)	GFT	1 322716
	Jgo. múltiple admisión (2)	NFT	1 322717
	Base bomba aceite	PLAST	1 302627
	O´ring G 101.19 x 3.53	GS	1
	O´ring G 50.39 x 3.53	GS	1
	O´ring G 20.3 x 2.62	GS	1
	O´ring G 7.52 x 3.53	GS	20
	Kit de retenes completo		R322800
	Jgo. retén válvulas (20)	P	1 R322710P
	Retén bancada 92 x 108 x 9.8	P	1 R300311P
	Retén distribución 47 x 63.4 x 8.8	P	1 R340712P

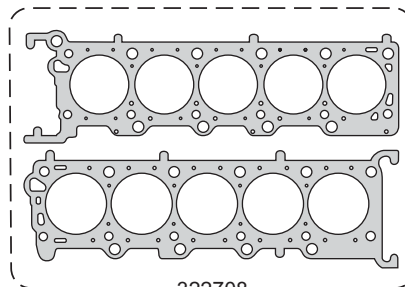

322708

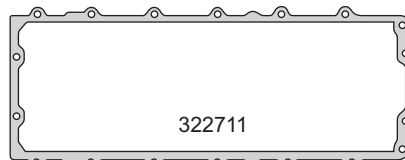

322711

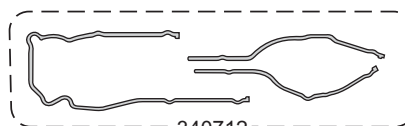

340712

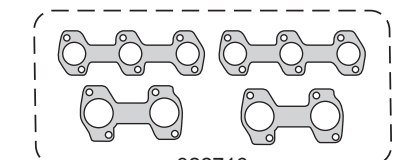

322716

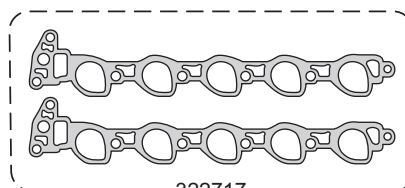

322717



302627



G 101.19 x 3.53



G 20.3 x 2.62



G 50.39 x 3.53



G 7.52 x 3.53



R300311P



R340712P

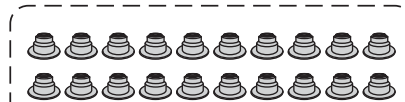

R322710P

FORD

FORD



Motor/Engine **Cm³** **HP** **Ø**

Tritón V10 **6760** **310** **90**

Ford: F-450 2000/03 - Excursion
E-Series - F-Series Super Duty
(incluye junta múltiple de admisión con ventana cuadrada)



Nº OE	Descripción/Description	Mat.	Ref.
	Jgo. de juntas para motor		322800-R
	Junta tapa de cilindros Ø 92 ± 0.88	MLS	1 322708
	Junta para cárter	PLAST	1 322711
	Jgo. cierre distribución (3)	PLAST	1 340712
	Jgo. múltiple escape (4)	GFT	1 322716
	Jgo. múltiple admisión (2)	PLAST	1 322817
	Base bomba aceite	PLAST	1 302627
	O'ring G 101.19 x 3.53	GS	1
	O'ring G 50.39 x 3.53	GS	1
	O'ring G 20.3 x 2.62	GS	1
	O'ring G 7.52 x 3.53	GS	20
	Kit de retenes completo		R322800
	Jgo. retén válvulas (20)	P	1 R322710P
	Retén bancada 92 x 108 x 9.8	P	1 R300311P
	Retén distribución 47 x 63.4 x 8.8	P	1 R340712P

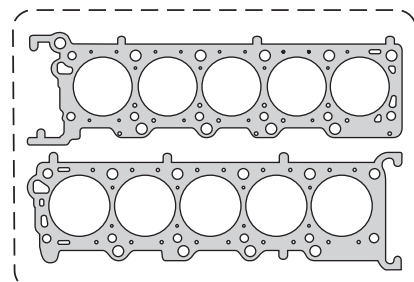

322708



322711

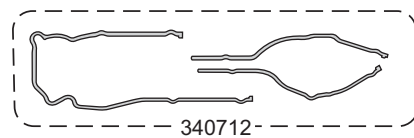

340712

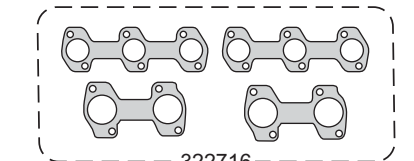

322716

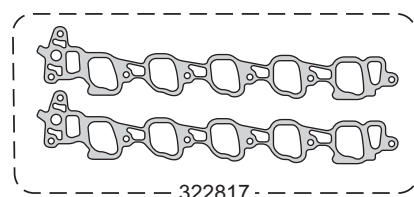

322817



302627



G 101.19 x 3.53



G 20.3 x 2.62



G 50.39 x 3.53



G 7.52 x 3.53



R300311P



R340712P



R322710P

FORD

FORD



Motor/Engine **Cm³** **HP** **Ø**

Duratec V6 RFF **2967** **200** **89**

Ford: Escape 2001/04



Nº OE	Descripción/Description	Mat.			Ref.
	Jgo. de juntas para motor				322900-R
	Jgo. de juntas superior	●	●		322995
	Jgo. jta. tapa cil. Ø 91.5 ± 0.90 (2)	MLS	1	1	322908
	Junta tapa válvulas izquierda	GS	1	1	322910-I
	Junta tapa válvulas derecha	GS	1	1	322910-D
4139726	Junta para cárter	AC/GS		1	302511
7224827	Junta distribución central	GS		1	302512-1
7224828	Junta distribución izquierda	GS		1	302512-2
7224826	Junta distribución derecha	GS		1	302512-3
6691888	Bomba de agua	CB		1	320314
	Bomba de agua	NB		1	302514
4503102	Jgo. múltiple escape (2)	AC	1	1	302515
	Jgo. múltiple admisión (6)	GS	1	1	322917-1
	Jgo. múltiple admisión (6)	GS	1	1	322917-2
	Junta	GS		1	322930
13342711	Junta o ring termostato G 47.22 x 3.53	GS		1	302531
	Junta	GS			322931
	Junta varilla aceite	NFT		1	340731
	Junta	GS	6	6	322933
	Junta	AC/GS	24	24	322934
1S7Z-9F670AA	Junta válvula reguladora paso a paso	GS		1	302235
3780203	Junta o ring refrigerador aceite G 66.27 x 3.53	GS		1	302535
	Junta	AC/GS		1	322935
	O ring G 20.30 x 2.62	GS		2	
	O ring G 7.52 x 3.53	GS	12	12	
	Kit de retenes completo				R302500
	Jgo. retén válvulas (24)	V		1	R302510V
F4AZ-6701A	Retén bancada 92 x 108 x 9.8	P		1	R300311P
F3AE-6700A	Retén distribución 47 x 63.4 x 8.8	P		1	R340712P

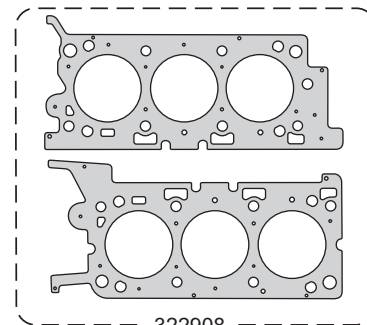

322908

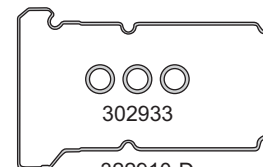

302933

322910-D

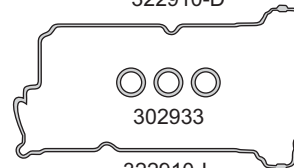

302933

322910-I

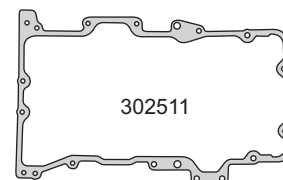

302511

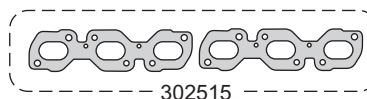

302515



322917-1



322917-2

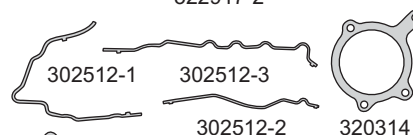

302512-1

302512-3

302512-2

320314



302514

340731

322935

302235



322934

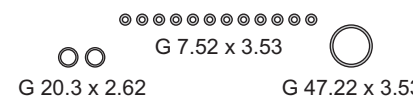

G 7.52 x 3.53

G 20.3 x 2.62

G 47.22 x 3.53

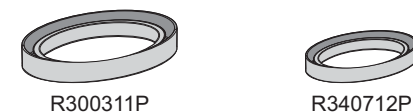

R300311P

R340712P

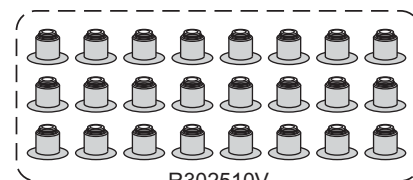

R302510V

FORD

FORD



Motor/Engine **Cm³** **HP** **Ø**

232 V6 **3797** **200** **97**

Ford: Windstar 1995/96



Nº OE	Descripción/Description	Mat.			Ref.
	Jgo. de juntas para motor		●	●	323200-R
	Jgo. de juntas superior		●		323295
	Jgo. jta. tapa cil. Ø99.7±1.40 (2) N.R.®	GFT	1	1	320207
	Sellador líquido - caucho de silicona				TRN0280R
	Junta tapa válvulas	GS	2	2	323210
	Cogotera para cárter	CG	1	1	320211-3
	Tapa distribución	CB	1	1	320212
	Tapa bomba de agua	CB	1	1	320214
	Jgo. múltiple escape (2)	NFT	1	1	320215
	Junta múltiple admisión superior	NFT	1	1	320217
	Jgo. múltiple admisión (4)	NFT	1	1	320217-1
	Junta brida	NFT	1	1	340526
	Junta cierre admisión delantera	CG	1	1	323230
	Junta cierre admisión trasera	CG	1	1	323231
	Junta o'ring tubo conector agua G 26.64 x 2.62	GS	2	2	302534
	Kit de retenes completo				R323200
	Jgo. retén válvulas (12)	P	1	1	R322310P
	Retén bancada 92 x 108 x 9.8	P	1	1	R300311P
	Retén distribución 47.62 x 67.07 x 8	V	1	1	R340512V

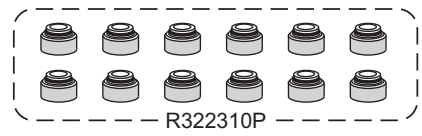
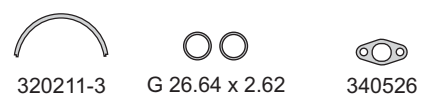
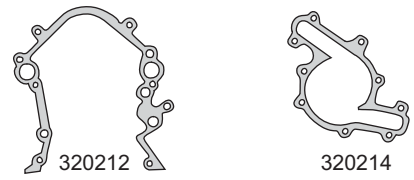
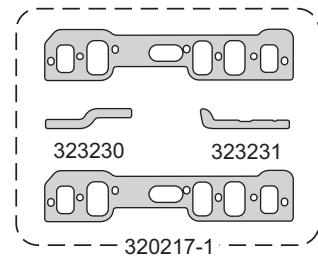
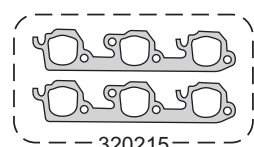
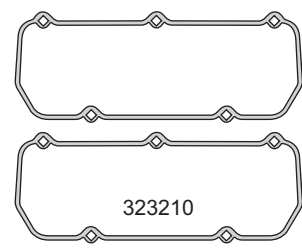
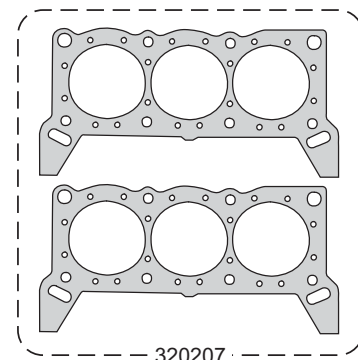

FORD

FORD



Motor/Engine **Cm³** **HP** **Ø**

Essex V6 **3797** **155** **96.8**

Ford: Windstar 1997/98



Nº OE	Descripción/Description	Mat.	Ref.
	Jgo. de juntas para motor		323300-R
	Jgo. junta tapa cil. Ø 100 ± 1.20 (2)	NFT	1 323307
	Sellador líquido - caucho de silicona		TRN0280R
	Junta tapa válvulas	GS	2 323210
	Cogotera para cárter	CG	1 320211-3
	Tapa distribución	CB	1 320212
	Tapa bomba de agua	CB	1 320214
	Bomba de agua	NB	1 323314
	Jgo. múltiple escape (2)	NFT	1 323316
	Jgo. múltiple admisión (4)	VS	1 323317
	Junta termostato	CB	1 320219
	Junta brida	NFT	1 340526
	Junta	CB	2 323128
	Junta cierre admisión	GS	1 323330
	Junta cierre admisión	GS	1 323331
	Jgo. entre múltiple (8)	GS	1 323332
	Junta	GS	1 323333
	Junta	GS	1 323334
	Arandela A 15 x 19 x 1.5 A	AL	1
	O´ring G 37.69 x 3.53	GS	1
	O´ring G 7.52 x 3.53	GS	6
	Kit de retenes completo		R323300
	Jgo. retén válvulas (12)	P	1 R323310P
	Retén bancada 92 x 108 x 9.8	P	1 R300311P
	Retén distribución 47 x 65/80 x 15	P	1 R340412P

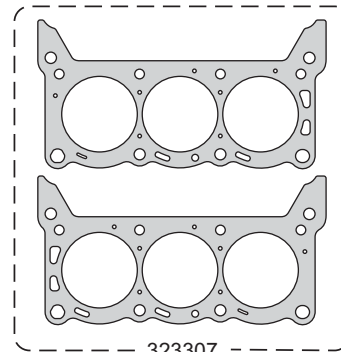

323307

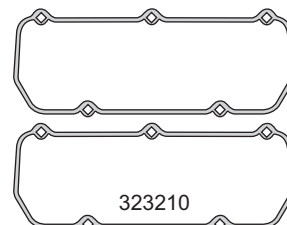

323210

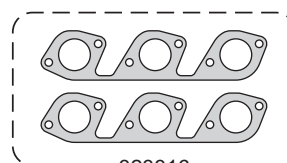

323316

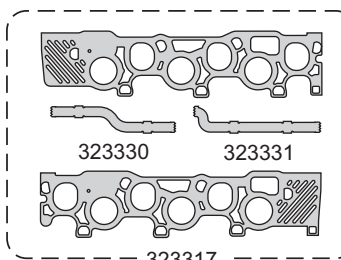

323317

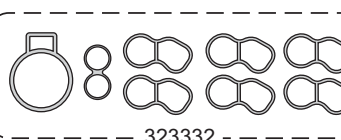

323332

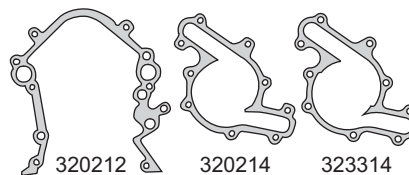

320212

320214

323314



320211-3

323128

320219



340526

323333

323334



A 15 x 19 x 1.5 A

G 7.52 x 3.53

G 37.69 x 3.53



R300311P

R340412P

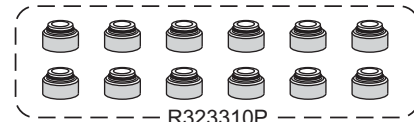

R323310P

FORD



Motor/Engine

Cm³

HP

Ø

Vulcan V6

2968

147

89

Ford: Camioneta Ranger 1996/01



Nº OE	Descripción/Description	Mat.	Ref.
	Jgo. de juntas para motor		● 323700-R
	Jgo. junta tapa cil. Ø 91.5 ±1.20 (2)	NFT	1 323707
	Junta tapa válvulas	GS	2 323010-2
	Junta para cárter	CG	1 323711
	Tapa distribución	NB	1 323012
	Tapa bomba de agua	NB	1 323014
	Jgo. múltiple escape (2)	NFT	1 323015
	Jgo. múltiple admisión (4)	NB	1 323017
	Junta termostato	CB	1 320219
	Arandela drenaje cárter A 14 x 21 x 2	PLAST	1 310930
	Junta	NB	1 323032
	Kit de retenes completo		R323700
	Jgo. retén válvulas (12)	V	1 R323010V
	Retén bancada 88 x 108 x 10	V	1 R320311V
	Retén distribución 47.62 x 67.07 x 8	V	1 R340512V

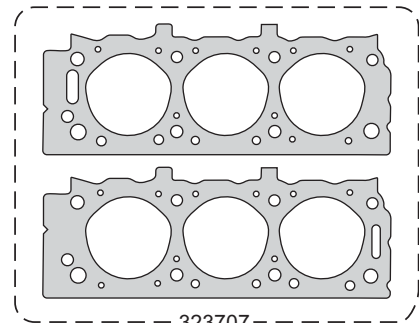

323707

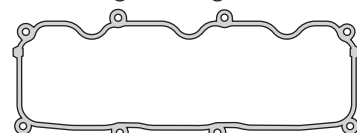
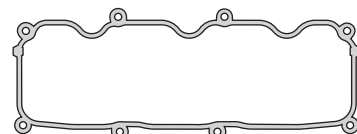

323010-2

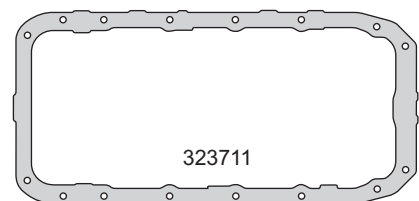

323711

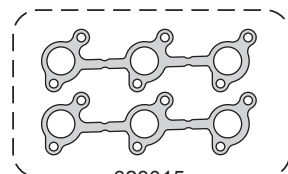

323015

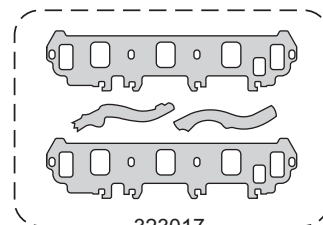

323017

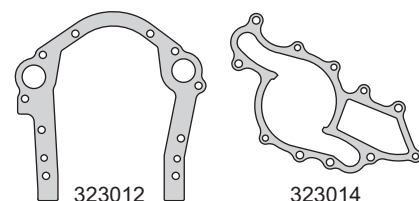

323012

323014



320219

323032

310930

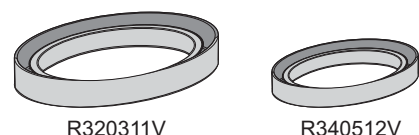

R320311V

R340512V

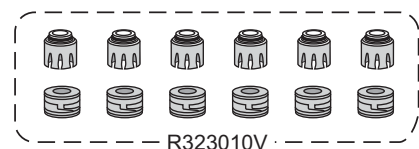

R323010V

FORD

FORD



Motor/Engine Cm³ HP Ø

Essex V6 3797 145 96.8

Ford: Windstar 1998/...



Nº OE	Descripción/Description	Mat.		Ref.
	Jgo. de juntas para motor		●	323900-R
	Jgo. de juntas superior		●	323995
	Jgo. jta. tapa cil. Ø100 ± 1.20 (2) N.R.	NFT	1 1	323307
	Junta tapa válvulas	GS	2 2	323210
	Cogotera para cárter	CG	1	320211-3
	Tapa distribución	CB	1	320212
	Tapa bomba de agua	CB	1	320214
	Bomba de agua	NB	1	323314
	Jgo. múltiple escape (2)	NFT	1 1	323316
	Jgo. múltiple admisión (4)	VS	1 1	323917
	Junta termostato	CB	1 1	320219
	Junta brida	NFT	1 1	340526
	Junta	NB	2 2	323128
	Junta cierre admisión	GS	1 1	323330
	Junta cierre admisión	GS	1 1	323331
	Jgo. entre múltiple (8)	GS	1 1	323332
	Junta	GS	1	323333
	Junta	GS	1	323334
	Arandela A 15 x 19 x 1.5 A	AL	1	
	O´ring G 37.69 x 3.53	GS	1 1	
	O´ring G 7.52 x 3.53	GS	6 6	
	Kit de retenes completo			R323300
	Jgo. retén válvulas (12)	P	1	R323310P
	Retén bancada 92 x 108 x 9.8	P	1	R300311P
	Retén distribución 47 x 65/80 x 15	P	1	R340412P

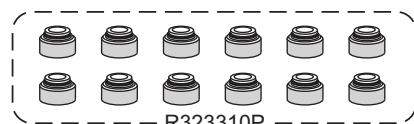
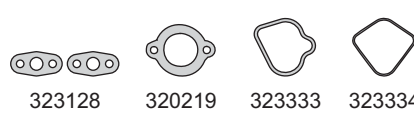
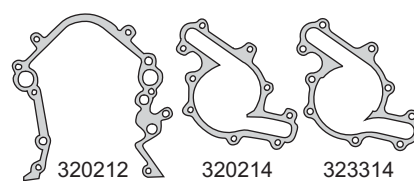
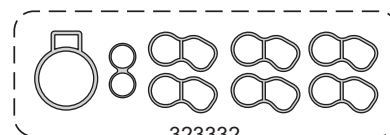
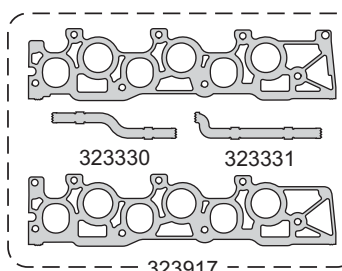
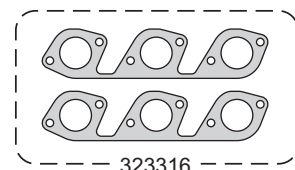
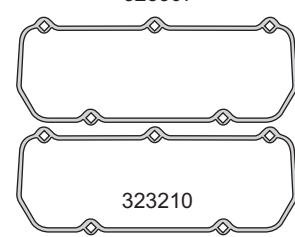
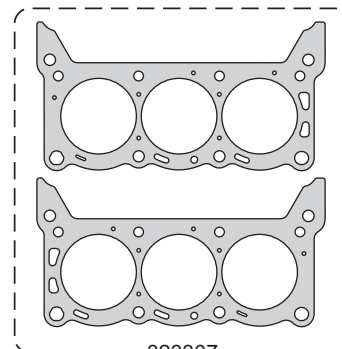

FORD

FORD



Motor/Engine **Essex V6** **3797** **200** **96.8**

Ford: Windstar 1999/00



Nº OE	Descripción/Description	Mat.			Ref.
	Jgo. de juntas para motor			●	324000-R
	Jgo. de juntas superior		●		324095
	Jgo. jta. tapa cil. Ø100 ± 1.20 (2) N.R.	NFT	1	1	323307
	Junta tapa válvulas	GS	2	2	323210
	Cogotera para cárter	CG	1		320211-3
	Tapa distribución	CB	1		320212
	Bomba de agua	NB	1		323314
	Jgo. múltiple escape (2)	NFT	1	1	323316
	Jgo. múltiple admisión (4)	VS	1	1	323917
	Junta brida	NFT	1	1	340526
	Junta cierre admisión	GS	1	1	323330
	Jgo. entre múltiples (7)	GS	1	1	324030
	Junta cierre admisión	GS	1	1	323331
	Junta	GS	1	1	324031
	Junta sello	AL/GS		1	302534
	Kit de retenes completo				R324100
	Jgo. retén válvulas (12)	P		1	R324010P
	Retén bancada 92 x 108 x 9.8	P		1	R300311P
	Retén distribución 47 x 65/80 x 15	P		1	R340412P

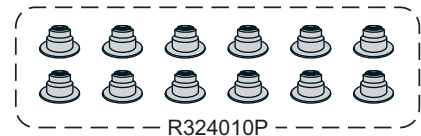
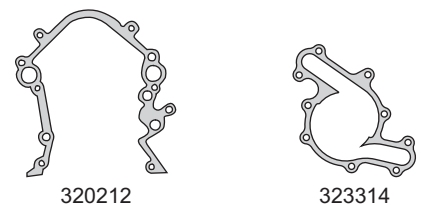
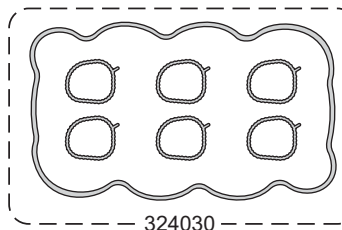
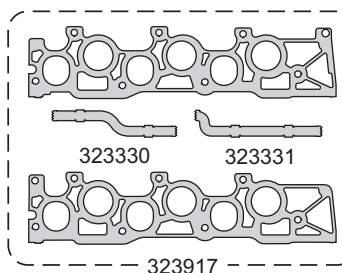
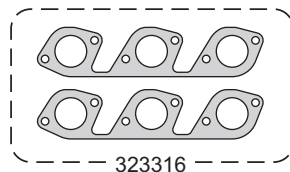
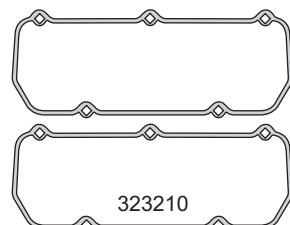
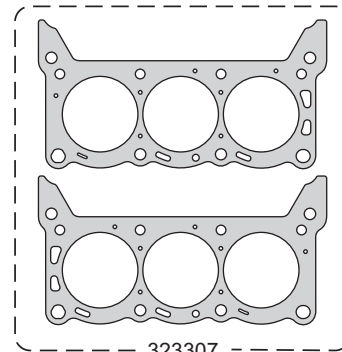

FORD

FORD



Motor/Engine	Cm³	HP	Ø
Essex V6	3797	200	96.8

Ford: Windstar 2001/03



Nº OE	Descripción/Description	Mat.		Ref.
	Jgo. de juntas para motor		●	324100-R
	Jgo. de juntas superior		●	324195
	Jgo. jta. tapa cil. Ø100 ± 1.20 (2) N.R.º	NFT	1 1	323307
	Sellador líquido - caucho de silicona			TRN0280R
	Junta tapa válvulas	GS	2 2	323210
	Cogotera para cárter	CG	1	320211-3
	Tapa distribución	NFT	1	320212-1
	Bomba de agua	NB	1	323314
	Jgo. múltiple escape (2)	NFT	1 1	323316
	Jgo. múltiple admisión (4)	VS	1 1	324117
	Junta termostato	CB	1 1	320219
	Junta brida	NFT	1 1	340526
	Junta cierre admisión	GS	1 1	323330
	Junta cierre admisión	GS	1 1	323331
	Junta	GS	1 1	324031
	Jgo. entre múltiples (7)	GS	1 1	324032
	O'ring G 37.69 x 3.53	GS		1
	Kit de retenes completo			R324100
	Jgo. retén válvulas (12)	P	1	R324010P
	Retén bancada 92 x 108 x 9.8	P	1	R300311P
	Retén distribución 47 x 65/80 x 15	P	1	R340412P

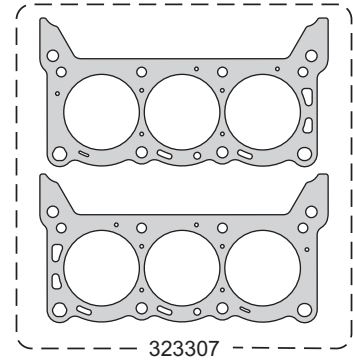

323307

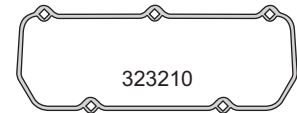
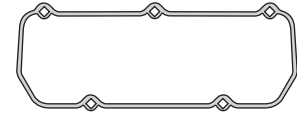

323210

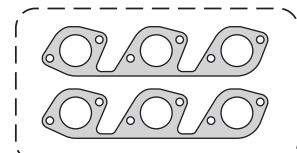

323316

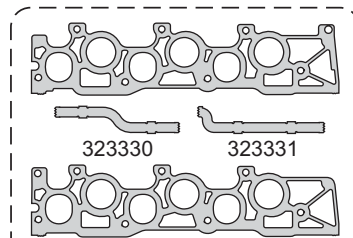

323330 323331

324117

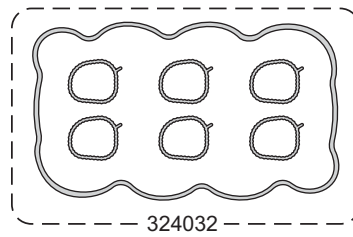

324032

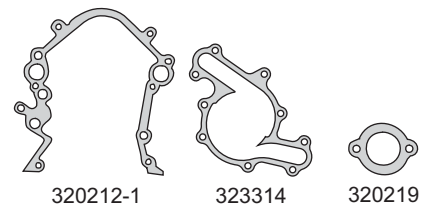

320212-1

323314

320219



320211-3

G 37.69 x 3.53

340526



R300311P

R340412P

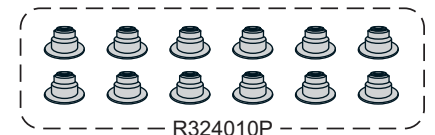

R324010P

FORD



Motor/Engine	Cm³	HP	Ø
4L 121 P.C.D. ZETEC VIN "3" (DOHC) 16V	1998	138	84.8

Ford: Contour 1996/98 - Mystique 1994/95
Escort ZX2 1998/...



Nº OE	Descripción/Description	Mat.	Ref.
	Jgo. de juntas para motor		324300-R
	Jgo. de juntas superior		324395
6847748	Junta tapa cilindros Ø 87 \pm 1.70 N.R.	NFT	1 1 320507
	Jgo. de tornillos JTC (HAT55055/HAT55100)		B320300
1663394	Conj. junta tapa válvulas (11)	GS	1 1 324310
7008824	Junta para cárter	N	1 1 320311
7378788	Frente bomba aceite	CB	1 1 320312
6691888	Bomba de agua	CB	1 1 320314
	Junta múltiple escape	AC	1 1 320315
1048093	Jgo. múltiple admisión 1997/... (4)	GS	1 1 320517
6669767	Junta aislante admisión	AL/GS	1 1 321517
1663383	Múltiple admisión	CB	1 1 320329
	Junta caja termostato	CB	1 1 320332
1663908	Chupador aceite	CB	1 1 320334
7090340	Mariposa gases	CB	1 1 320335
1663861	Bancada trasera	CB	1 320336
6759630	Anillo tapa válvulas G 8.5 x 13.4 x 5	GS	10 10 320337
	Arandela cárter A 15 x 21 x 2 A	AL	1
	Kit de retenes completo		R320300
	Jgo. retén válvulas (16)	V	1 R320310V
	Retén bancada 88 x 108 x 10	V	1 R320311V
	Retén distribución 35 x 50 x 7	V	1 R470013V
	Retén árbol levas 42 x 53 x 7	V	2 R320313V

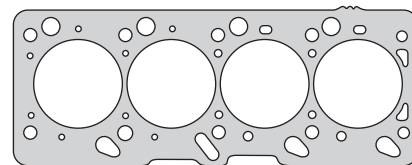

320507

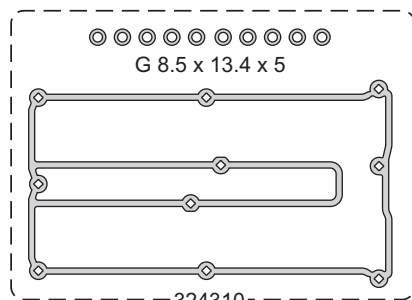

324310

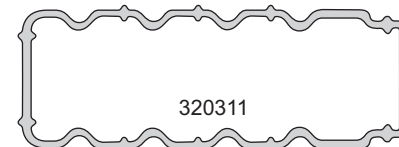

320311



320315

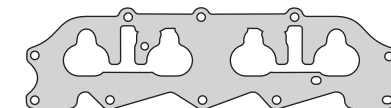

321517



320517

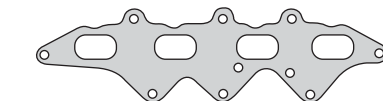

320329

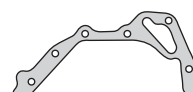

320312



320336



320314



320332



320334



320335



A 15 x 21 x 2A



R320311V



R470013V



R320313V

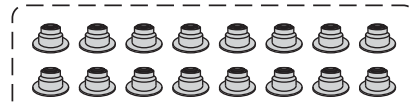

R320310V

FORD

FORD



Motor/Engine	Cm³	HP	Ø
Essex V6	4195	202	96.8

Ford: Econoline - F150 1997/98



Nº OE	Descripción/Description	Mat.	Ref.
	Jgo. de juntas para motor		324400-R
	Jgo. de juntas superior	●	324495
	Jgo. jta. tapa cil. Ø100 ± 1.20 (2)	NFT 1 1	323307
	Sellador líquido - caucho de silicona		TRN0280R
	Junta tapa válvulas	GS 2 2	323210
	Cogotera para cárter	GS 1	320211-3
	Tapa distribución	CB 1	320212
	Bomba de agua	NB 1	323314
	Jgo. múltiple escape (2)	NFT 1 1	323316
	Jgo. múltiple admisión (4)	VS 1 1	324117
	Junta termostato	CB 1 1	320219
	Junta	NB 2 2	323128
	Junta	NB 1 1	324430
	Junta cierre admisión	GS 1 1	323330
	Junta cierre admisión	GS 1 1	323331
	Junta	CB 1 1	322332
	Junta	GS 1	323334
	Cuerpo válvula cierre	CB 1 1	310936
	O'ring G 7.52 x 3.53	GS 6 6	
	Kit de retenes completo		R323300
	Jgo. retén válvulas (12)	P 1	R323310P
	Retén bancada 92 x 108 x 9.8	P 1	R300311P
	Retén distribución 47 x 65/80 x 15	P 1	R340412P

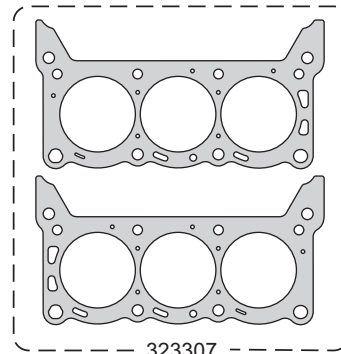

323307



323210

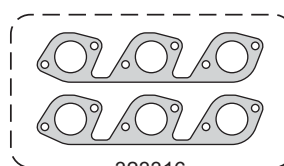
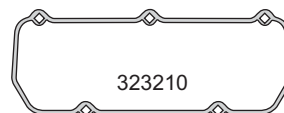

323316

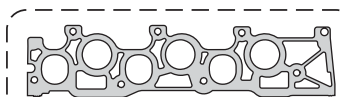

323330

323331



324117



320212



320211-3

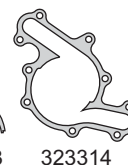

323314



323128



320219



324430



322332



323334



310936



G 7.52 x 3.53



R300311P



R340412P

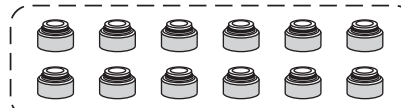

R323310P

FORD



Motor/Engine	Cm³	HP	Ø
Duratec-VCT (25KDTD)	2522	220/226	83
B5254T3/T6/T7/T8 Turbo 20V	2551	200/220	83

Ford: Focus - C-Max - S-Max - Mondeo - Kuga 2005/... - 2007/...

Volvo: S40 - V50 - C70 - C30 - S80 - V70 2004/08 - 2007/...



Nº OE	Descripción/Description	Mat.	Ref.
	Jgo. de juntas para motor		324700-R MLS
1370373	Junta tapa cilindros Ø 84 \times 1.30	MLS 1	324708
	Sellador líquido - caucho de silicona		TRN0280R
1388503	Bomba de agua	NB 1	324714
1371948	Múltiple escape	AC 1	324715
1370365	Múltiple admisión	SLS 1	324717
1371931	Junta carcasa termostato	GS 1	324719
1370471	Bomba de aceite	NB 1	324727
1371335	Guarnición enfriador aceite	GS 1	324728
1371340	Guarnición enfriador aceite	GS 1	324729
1370361	Válvula aceleradora	GS 1	324732
1369796	O´ring G 38 x 3	GS 1	
1370364	Anillo G 48 x 52 x 6	GS 1	
1371661	O´ring G 20.30 x 2.62	GS 1	
1371658	O´ring G 26.64 x 2.62	GS 1	
1371660	O´ring G 29.82 x 2.62	GS 1	
	Kit de retenes completo		R324700
1369754	Retén bancada 98 x 110 x 8.5	V 1	R324711V
1431668	Retén distribución 35 x 47 x 6	V 1	R324712V
1371718	Retén árbol de levas 51 x 65 x 7	V 1	R324713V

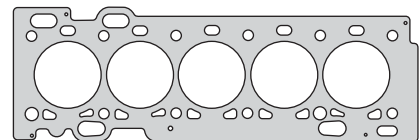

324708



324715

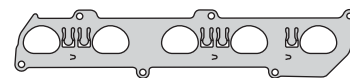

324717

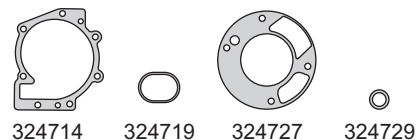

324714 324719 324727 324729



324728 324732 G 38 x 3



G 26.64 x 2.62



G 29.82 x 2.62 G 48 x 52 x 6

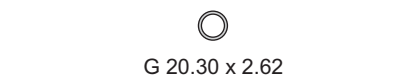

G 20.30 x 2.62



R324711V



R324712V



R324713V

FORD

FORD



Motor/Engine	Cm³	HP	Ø
Puma	2198	123	86
4HU (P22DTE)	2198	101/120	86
4HV (P22DTE) (DOHC) 16V	2198	101/120	86

DIESEL

Citroën: Jumper HDI 2006/...
Fiat: Ducato 2006/...
Ford: Ranger XL 4X2 - 4X4 TDCi
 Transit TDCi 2006/...
Peugeot: Boxer HDI 2006/...



Nº OE	Descripción/Description	Mat.	Ref.
	Jgo. de juntas para motor		302001-R
1096227/1	Junta tapa cilindros Ø 87.1 ± 1.10	MLS	324808-1M
	Junta tapa cilindros Ø 87.1 ± 1.15	MLS	324808-2M
	Junta tapa cilindros Ø 87.1 ± 1.20	MLS	324808-3M
1102674	Jgo. de tornillos para tapa de cilindros		B302000
1099778	Junta tapa válvulas	N	302010
1112953	Jgo. junta para cárter (2)	SLS	302011
	Junta para cárter	NB	303211
110268/1	Frete distribución	NB	302012
1121210	Distribución a block	SLS	302013
1096559	Bomba de agua	SLS	302014
1120402	Múltiple escape	AC	302015
	Jgo. múltiple admisión (9)	N	302017
1098228	Guarnición termostato	N	302019
1721342	Sello filtro de aceite	GS	302027
1094599	Bomba inyectora	SLS	340328
1146959	Bomba vacío	SLS	302029
1105321	Chupador aceite	NB	302020
1111912	Anillo refrigeración gases	SLS	302031
	Anillo admisión	N	302033
1754585	Junta tapa frontal	AL/GS	302034
1322526	Junta	SLS	302036
1794375	Junta bomba de vacío	AC/GS	302044
4640315	Arandela sello retén de block A 28 x 39 x 2	AC/GS	
	Kit de retenes completo		R302000
1096253	Jgo. retén válvulas (16)	V	R302010V
1117435	Porta retén bancada	V	PR302011V
1201417	Porta retén distribución	V	PR302012V
1139357	Retén árbol de levas 35 x 50 x 7	V	R470013V

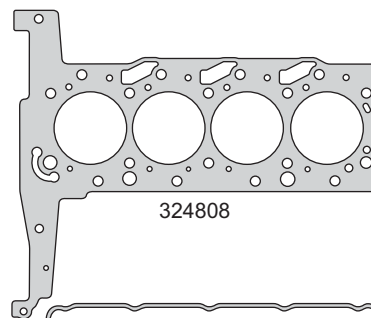

324808

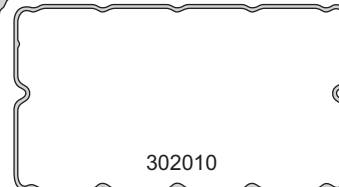

302010

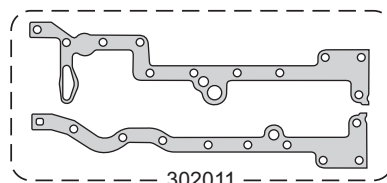

302011

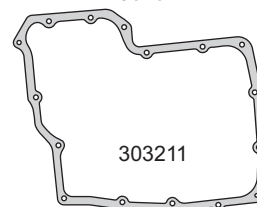

303211

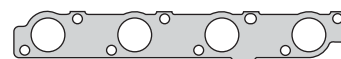

302015

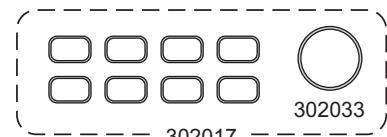

302017

302033

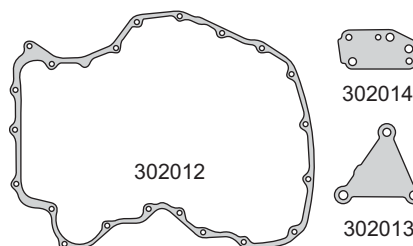

302012

302014

302013

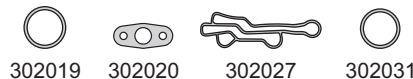

302019

302020

302027

302031

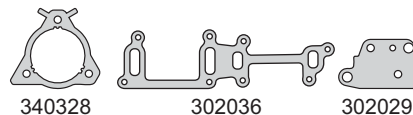

340328

302036

302029



302044

302034

A 28 x 39 x 2

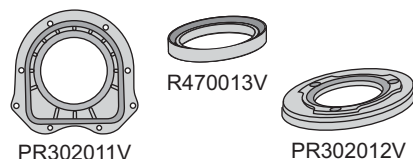

PR302011V

R470013V

PR302012V



R302010V

FORD

FORD



Motor/Engine	Cm³	HP	Ø
Puma TDCi 15 eTGV	3198	200	90

Ford: Ranger XLS/XLT 4X2 - 4X4 TDCi 2013/...

DIESEL



Nº OE	Descripción/Description	Mat.	Ref.
	Jgo. de juntas para motor		324901-R
1096227/1	Junta tapa cilindros Ø 91 \pm 1.10	MLS	324908-1M
	Junta tapa cilindros Ø 91 \pm 1.15	MLS	324908-2M
	Junta tapa cilindros Ø 91 \pm 1.20	MLS	324908-3M
BK3Q/6K260/AA	Junta tapa válvulas	N	324910
1748634	Jgo. junta para cárter (2)	SLS	324911
110268/1	Frente distribución	NB	302012
1121210	Distribución a block	SLS	302013
1096559	Bomba de agua	SLS	302014
1712448	Múltiple escape	AC	324915
	Jgo. múltiple admisión (11)	N	324917
1098228	Guarnición termostato	N	302019
1105321	Chupador aceite	NB	302020
1721342	Sello filtro de aceite	GS	302027
1094599	Bomba inyectora	SLS	340328
1146959	Bomba vacío	SLS	302029
1111912	Anillo refrigeración gases	SLS	302031
	Anillo admisión	N	302033
1754585	Junta tapa frontal	AL/GS	302034
1322526	Junta	SLS	302036
1794375	Junta bomba de vacío	AC/GS	302044
4640315	Arandela sello retén de block A 28 x 39 x 2	AC/GS	
	Kit de retenes completo		R324900
1096253	Jgo. retén válvulas (20)	V	R324910V
1117435	Porta retén bancada	V	PR302011V
1201417	Porta retén distribución	V	PR302012V
BK2Q/6K780/BA	Retén auxiliar 21 x 40 x 7.3	P	R324915P

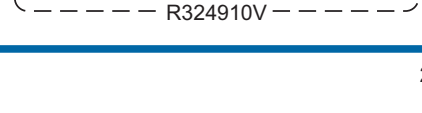
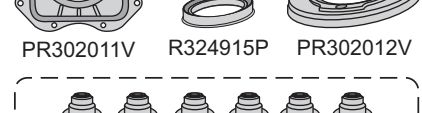
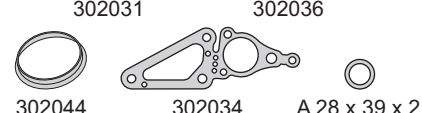
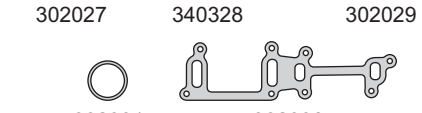
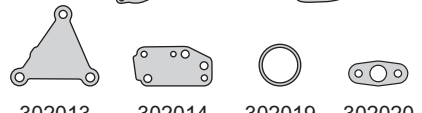
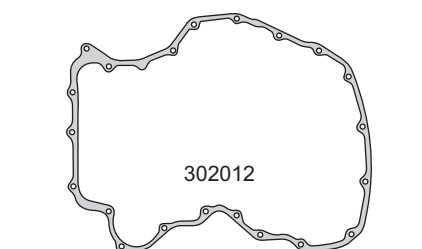
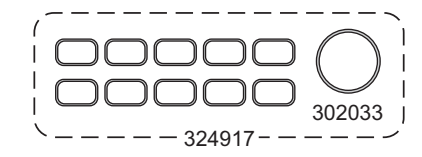
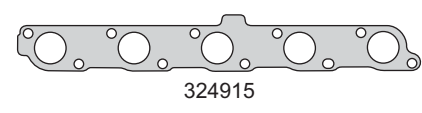
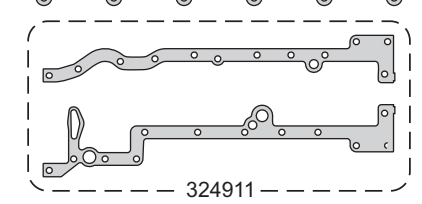
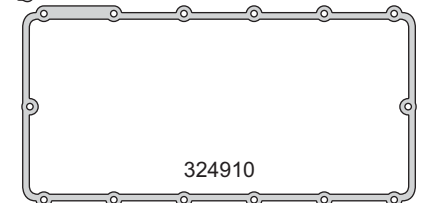
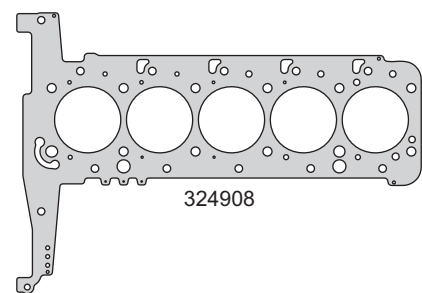

FORD

FORD



Motor/Engine	Cm³	HP	Ø
4EB/BC/CA/FB 4HC/EA	2496 2496	70/80 100	93.64 93.64

Ford: Transit - Transit D/DI 1985/99

DIESEL



Nº OE	Descripción/Description	Mat.	1	2	Ref.
	Jgo. de juntas para motor				330300-R
	Jgo. de juntas para motor		●		330300
	Jgo. de juntas superior				330395
6518302	Junta tapa cilindros Ø 96 ± 1.40 N.R.	NFT	1	1	330307
	Junta tapa cilindros Ø 96 ± 1.20 N.R.	NFT			330307-1.20
	Jgo. tornillos tapa cilindros (HAS17038)				B330300
6201251	Junta tapa válvulas	N	1	1	330310
6193087	Junta para cárter	CG		1	330311
6182958	Tapa distribución	NB		1	330312
6193530	Placa distribución	NH		1	330313
6771114	Tapa bomba de agua	NB		1	330314
6193676	Múltiple escape	NFT	1	1	330316
6525915	Múltiple admisión	NB	1	1	330317
	Salida de escape	NFT	1	1	330318
	Termostato	NB	1	1	330319
	Junta cámara agua	NB		1	280229
	Brida	NB		1	330329
6175933	Válvula reguladora de gases	AC	3	3	320030
	Acople termostato	NB	1	1	330330
	Calefactor	NB		1	330331
6909744	Entre múltiples colectores	NFT	1	1	330334
	Porta retén	NB		1	330336
ERR/4621/B	Ar. iny. parallamas c/realse A 7.3 x 15.8 x 0.8 C	CU	4	4	330337
6197861	Salida de escape 1991/96 sin turbo				330338
6646724	Salida de escape múltiple				330348
7347007	Tapa diferencial tipo 34 (chico) 14 pulgadas				330359
6175734	Tapa diferencial tipo 51 (grande) 15 pulgadas				330361
	Anillos G 8.5 x 13.4 x 5	GS	4	4	
	Arandela A 15 x 21 x 2 A	AL		1	
	O´ring G 31.5 x 3.2	GS		2	
	O´ring G 70 x 3	GS		1	
ERR/4685/B	O´ring caja termostato G 21 x 3	GS		1	
	O´ring G 18 x 3	GS		1	
	O´ring G 19.25 x 2.9	GS		3	
	O´ring G 21.89 x 2.62	GS	1		
7092008	Arandela tapón cárter A 19 x 27 x 1.5 A	AL			
ERR/0894/A	Arandela tubo combustible A 12 x 18 x 1.5 A	AL			
70920120	Arandela bomba vacio A 10 x 15 x 1.5 A	AL	2		
70920127	Arandela filtro gasoil A 6 x 10 x 1 C	CU	4		
70920096	Arandela retorno gasoil A 14 x 20 x 1.5 C	CU	8		
	Kit de retenes completo				R330300
6597036	Jgo. retén válvulas (8)	P		1	R330310P
6182960	Retén bancada 79.3 x 99 x 9.8	V		1	R330311V
6182959	Retén distribución 66.67 x 85.7 x 10	V		1	R330312V
6182957	Retén árbol de levas 47.6 x 66.7 x 11	V		1	R330313V

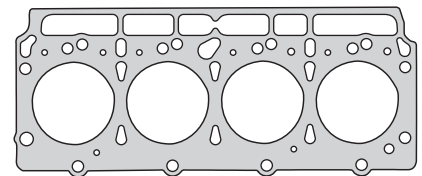

330307

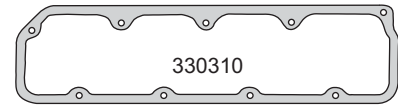

330310

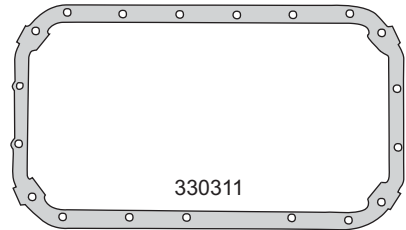

330311

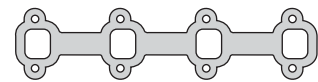

330316

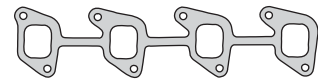

330317

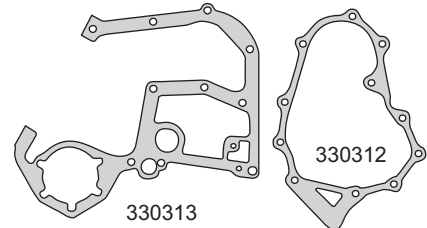

330313

330312

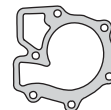

330314



330318



330319



330329



280229

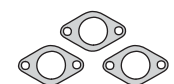

320030



330330



330331



330334



330337



330338



330336



330348



R330311V



R330312V



R330313V

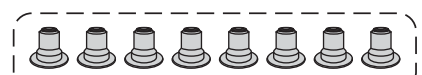

R330310P

FORD

FORD



Motor/Engine	Cm³	HP	Ø
Zetec Rocam ZL	999	65	68.69

Ford: Ka 1999/...



Nº OE	Descripción/Description	Mat.	Ref.
	Jgo. de juntas para motor		340100-R
	Jgo. de juntas superior		340195
	Jgo. de juntas superior (MLS)		340195 MLS
XS6E/6051BE	Junta tapa de cilin. Ø 70 ± 1.20	NFT	1 1 340107
XS6E/6051BE	Junta tapa de cilin. Ø 70 ± 0.35	MLS	340108
	Jgo. de tornillos para tapa de cilindros		B340100
XS6E/6584AB	Junta tapa válvulas	GS	1 1 340110
XS6E/6710/A2B	Junta para cárter	GS	1 1 340111
XS6E/9448AC	Múltiple escape	SLS	1 1 340115
XS6E/9441BA	Jgo. múltiple admisión (2)	GS	1 1 340117
XS6E/8255BB	Carcasa termostato	GS	1 1 340119
XS6E/6659/A2B	Junta bomba aceite - agua	SLS	1 340127
W/703273/S300	Anillo termostato	GS	340129
XS6E/6K780AC	Guarnición salida gases	GS	340130
XS6E/9P848AA	Guarnición válvula mariposa	GS	1 340131
XS6E/6L621AD	Soporte filtro aceite	NB	1 340132
958F/9F670BB	Válvula IAC	GS	1 1 340133
	O´ring G 47.22 x 3.53	GS	1 1
	Kit de retenes completo		R340100
XS6E/6571AA	Jgo. retén válvulas (8)	V	1 R340110V
XS6E/6K301CA	Porta retén bancada trasera	V	PR340111V
XS6E/6700BA	Retén distribución 39.95 x 62 x 7.4	V	1 R340112V
	Retén bomba de aceite 40 x 62 x 7.4	V	1 R340115V

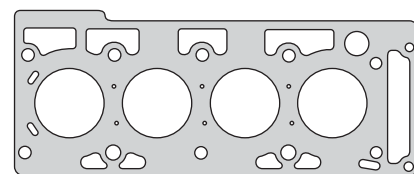

340107

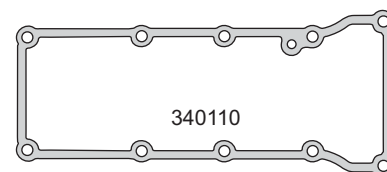

340110

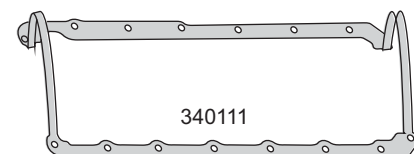

340111



340115

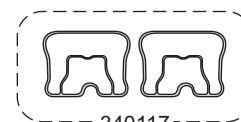

340117



340119



340127



340130



340131



G 47.22 x 3.53



340132



340133



PR340111V



R340112V



R340115V



R340110V

FORD

FORD



Motor/Engine	Cm³	HP	Ø
Zetec Rocam ZL (SOHC) 8V	1598	95/105 110	82

Ford: Ka 1997/... - Fiesta 1999/... - Escort Eco Sport - Focus - Courier 2003/...



Nº OE	Descripción/Description	Mat.	Ref.
	Jgo. de juntas para motor		340200-R
	Jgo. de juntas superior	●	340295
	Jgo. de juntas superior (MLS)		340295 MLS
XS6E/6051AC	Junta tapa cilindros Ø 83 ± 1.20	NFT	1 1 340207
XS6E/6051AC	Junta tapa cilindros Ø 83 ± 0.35	MLS	340208
	Jgo. de tornillos para tapa de cilindros		B340100
XS6E/6584AB	Junta tapa válvulas	GS	1 1 340110
XS6E/6710/A2B	Junta para cárter	GS	1 1 340111
XS6E/9448BB	Múltiple escape	SLS	1 1 340215
	Múltiple escape Ø35 - 2003/...	SLS	340215-1
XS6E/9441AB	Jgo. múltiple admisión (2)	GS	1 1 340217
XS6E/8255BB	Carcasa termostato	GS	1 1 340119
XS6E/6659/A2B	Junta bomba aceite - agua	SLS	1 340127
W/703273/S300	Anillo termostato	GS	340129
XS6E/6K780AC	Guarnición salida gases	GS	340130
XS6E/9P848AA	Guarnición válvula mariposa	GS	1 340131
XS6E/6L621AD	Soporte filtro aceite	NB	1 340132
958F/9F670BB	Válvula IAC	GS	1 1 340133
	O'ring 47.22 x 3.53	GS	1 1
	Kit de retenes completo		R340200
XS6E/6571AA	Jgo. retén válvulas (8)	V	1 R340110V
XS6E/6K301CA	Porta retén bancada trasera	V	PR340111V
XS6E/6700BA	Retén distribución 39.95 x 62 x 7.4	V	1 R340112V

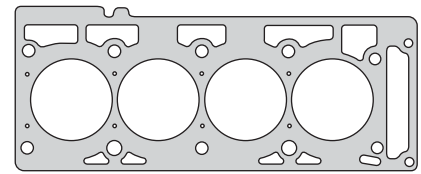

340207

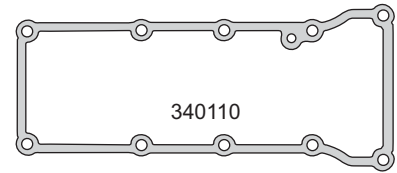

340110

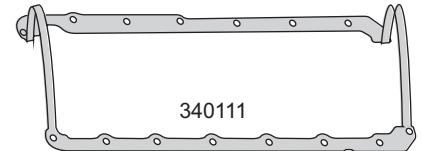

340111



340215



340215-1

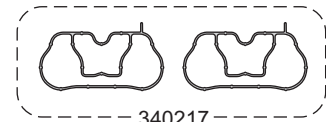

340217



340119

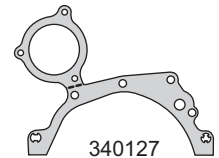

340127



340130



340131



G 47.22 x 3.53



340132



340133



R340112V



PR340111V



R340110V

FORD



Motor/Engine	Cm³	HP	Ø
Lynx (C9DC)	1753	90/75	82.5
Duratorq	1753	115	82.5
BHDA/BHDB	1753	75	82.5

Ford: Focus TD di 1998/... - Fiesta TD di 2000/...
Focus TD ci 2001/... - Focus di 1999/...

DIESEL



Nº OE	Descripción/Description	Mat.	Ref.
	Jgo. de juntas para motor		340301-R
	Junta tapa cilindros Ø 84 \pm 1.20	NFT	340307-1M
	Junta tapa cilindros Ø 84 \pm 1.30	NFT	340307-2M
	Junta tapa cilindros Ø 84 \pm 1.40	NFT	340307-3M
	Junta tapa cilindros Ø 84 \pm 1.50	NFT	340307-4M
	Junta tapa cilindros Ø83.5 \pm 1.20	MLS	340308-2M
	Junta tapa cilindros Ø83.5 \pm 1.25	MLS	340308-3M
	Junta tapa cilindros Ø83.5 \pm 1.30	MLS	340308-4M
	Junta tapa cilindros Ø83.5 \pm 1.35	MLS	340308-5M
	Junta tapa cilindros Ø83.5 \pm 1.40	MLS	340308-6M
	Junta tapa cilindros Ø83.5 \pm 1.42	MLS	340308-7M
1.079.925/926	Jgo. tornillos tapa cilin. (HAT60100/HAT60055)		B340300
1.078.524	Conj. junta tapa válvulas (4)	GS 1	340310
1.078.498	Junta para cárter	GS 1	340311
1.078.522	Junta frente	SLS 1	340312
1.078.500	Bomba de agua	SLS 1	340314
1.092.074	Múltiple escape	NFT 1	320015
	Múltiple escape	AC	320016
6.740.296	Múltiple admisión	CB 1	320017
6.180.424	Múltiple admisión turbo	NFT 1	340317
6.740.297	Salida de escape turbo	NFT 1	320018
1.032.504	Carcasa termostato	CB 1	320019
1.113.202	Frente motor bomba aceite (1104416)	SLS 1	340327
1.094.599	Junta bomba inyectora	SLS 1	340328
1.113.210	Junta intercooler	SLS 1	340329
1.102.444	Colector a turbo	SLS	340330
1.021.499	Anillo termostato	GS 1	560131
89FF8255AA	Arandela tapa válvulas	GS 3	320033
	Junta cárter inferior	NB 1	340338
	Kit de retenes completo		R340300
1.644.647	Jgo. retén válvulas (8)	V 1	R320010V
1.078.528	Porta retén bancada	V	PR320011V
	Porta retén bomba inyectora	P	PR340314P
1.101.468	Retén distribución 30 x 50 x 7.5	V 1	R340312V
6.135.090	Retén árbol de levas 28 x 38 x 7	V 1	R320013V

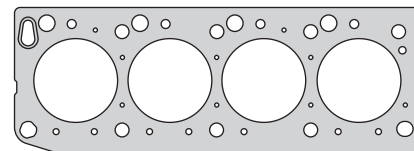

340307

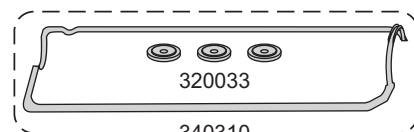

320033

340310

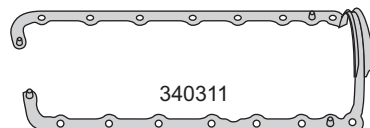

340311

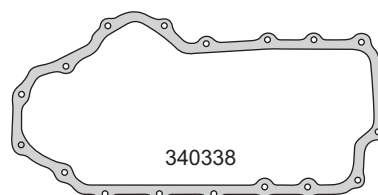

340338



320015

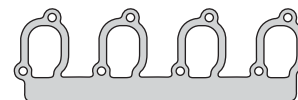

320017



340317

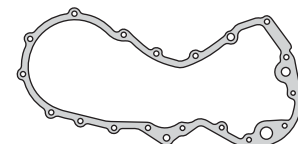

340327

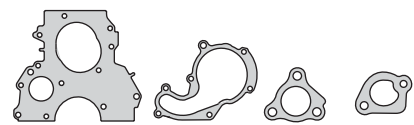

340312

340314

320018

320019



340328

340329

340330

560131

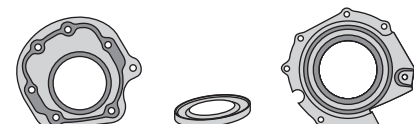

PR320011V

R340312V

PR340314P



R320013V

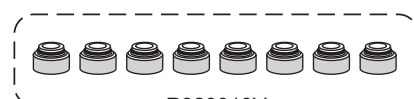

R320010V

FORD

FORD



Motor/Engine Cm³ HP Ø

F460L V8 7500 110

Ford: F100 - 250/350
Econoline 250/350 1985/87



Nº OE	Descripción/Description	Mat.	Ref.
	Jgo. de juntas para motor		340400-R
	Jgo. junta tapa cilindro Ø 114 \pm 1.30	NFT 1	340407
	Junta tapa de válvulas	CG 2	340410
	Jgo. junta para cárter (4)	CG 1	340411
	Tapa distribución	CB 1	340412
	Bomba de agua	CB 1	340414
	Bomba de agua	CB 1	340414-1
	Jgo. múltiple escape (2)	NFT 1	340417
	Jgo. múltiple escape (4)	NFT 1	340417-1
	Salida de escape	FCH 2	300018
	Junta termostato	CB 1	310319
	Junta	CB	310419
	Junta	CB 1	340519
	Bomba de agua	CB	340421
	Junta	NFT	340422
	Junta	CB	340423
	Junta	CB	340424
	Base bomba nafta	CB 1	200028
	Junta	NH 1	340430
	Junta	NH 1	340431
	Junta	NH 1	340432
	Junta	CB 1	340532
	Jgo. juntas empaquetadura bancada (2)	SNA 1	300058
	Arandela A 14 x 18 x 1.5 A	AL 1	
	Arandela A 130 x 142 x 1.6	CG 1	
	O´ring G 34.59 x 2.62	GS 1	
	O´ring G 67.95 x 2.62	GS 1	
	Kit de retenes completo		R340400
	Jgo. retén válvulas (16)	P 1	R320710P
	Retén distribución 48 x 65 x 7.85	N 1	R320712N

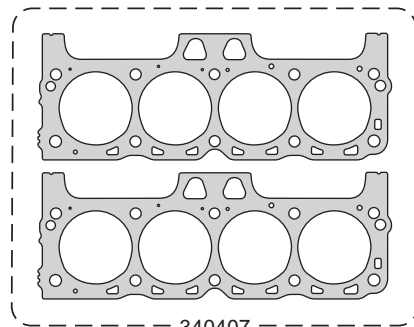

340407

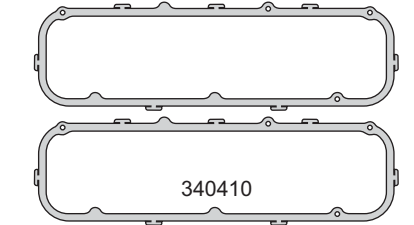

340410

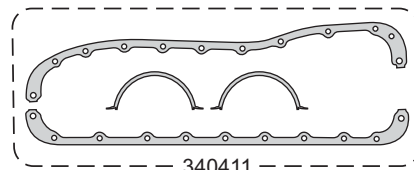

340411

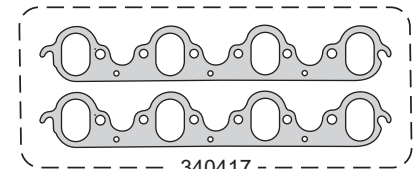

340417

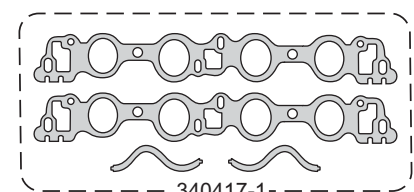

340417-1

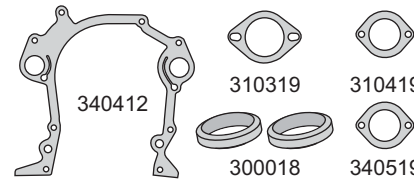

340412

310319

310419

300018

340519

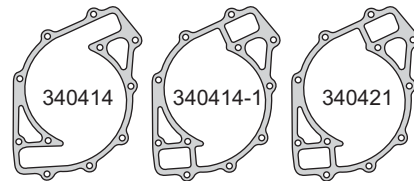

340414

340414-1

340421



200028

340422

340424

340432

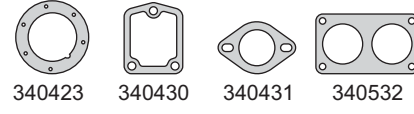

340423

340430

340431

340532

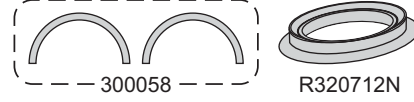

300058

R320712N

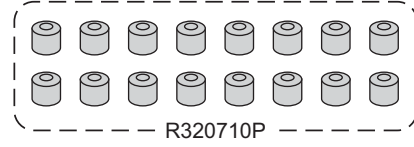

R320710P

FORD

FORD



Motor/Engine **460 CID V8** Cm³ **7500** HP Ø **110**

Ford: Monterey - Torino - Cougar - Continental Mark III - IV - V 1988/94



Nº OE	Descripción/Description	Mat.		Ref.
	Jgo. de juntas para motor			340500-R
	Jgo. de juntas superior		●	340595
	Jgo. jta. tapa cil. Ø114 ± 1.30 (2)	NFT	1 1	340507
	Jgo. junta tapa de válvulas (2)	GS	1 1	340510
	Junta para cárter	GS	1 1	340511
	Tapa distribución	CB	1 1	340412
	Bomba de agua	CB	1 1	340414
	Bomba de agua	CB	1 1	340414-1
	Jgo. múltiple escape (2)	NFT	1 1	340515
	Jgo. múltiple admisión (4)	NFT	1 1	340517
	Junta	CB	1 1	340519
	Junta	NFT	1 1	340522
	Junta	NFT	2 2	340526
	Junta	CB	1 1	340527
	Base bomba nafta	CB	1 1	200028
	Junta	NFT	1 1	340528
	Junta	SLS	1 1	340529
	Junta unión múltiples	GS	2 2	340531
	Junta base carburador	CB	2 2	340532
	Junta	CB	1 1	340533
	Junta entrada aire	CB	1 1	340837
	O´ring G 32.99 x 2.62	GS	1 1	
	O´ring G 25.12 x 1.78	GS	1 1	
	O´ring G 23.52 x 1.78	GS	1 1	
	O´ring G 21.89 x 2.62	GS	1 1	
	O´ring G 7.52 x 3.53	GS	16 16	
	Kit de retenes completo			R340500
	Jgo. retén válvulas (16)	P	1 1	R340510P
	Retén bancada (dos mitades)	N	1 1	R340511-1N
	Retén distribución 47.62 x 67.07 x 8	V	1 1	R340512V

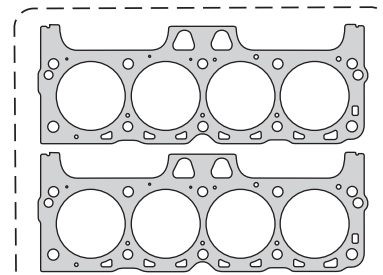

340507

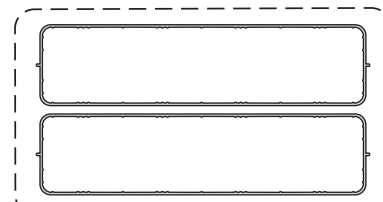

340510

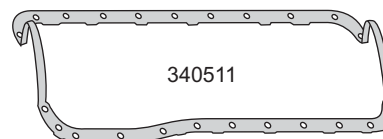

340511

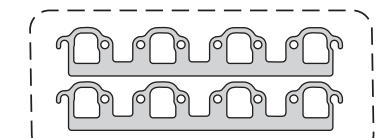

340515

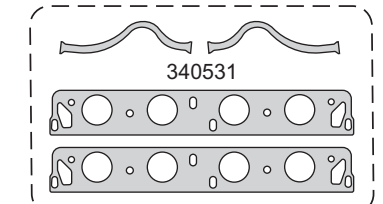

340531

340517

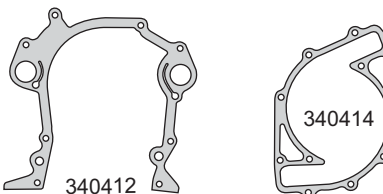

340412

340414

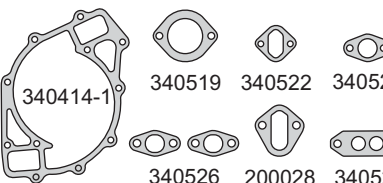

340414-1

340519

340522

340527

340526

200028

340528

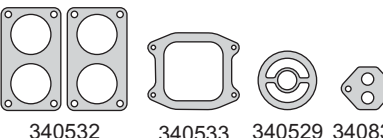

340532

340533

340529

340837

G 32.99 x 2.62

G 25.12 x 1.78

G 7.52 x 3.53

21.89 x 2.62

23.52 x 1.78



R340512V



R340510P

FORD

FORD



Motor/Engine Cm³ HP Ø

F140L (SOHC) 8V 2298 106 96

Ford: Mustang - Ranger 1993/94
Ranger 1995/97 - Pick Up 1989/...



Nº OE	Descripción/Description	Mat.		Ref.
	Jgo. de juntas para motor		●	340600-R
	Jgo. de juntas superior		●	340695
	Jta. tapa cilindros Ø 100 \pm 1.30 N.R.	NFT	1 1	340607
	Jgo. de tornillos para tapa de cilindros			B300300
	Junta tapa de válvulas	GS	1 1	340610
	Junta para cárter	GS	1 1	340611
	Múltiple admisión	GFT	1 1	340616-1
	Múltiple admisión	NFT	1 1	340617
	Termostato	NFT	1 1	340619
	Base termostato	NB	1 1	302329
	Larguero	GS	1 1	340633
	Junta o´ring tubo conector agua G 26.7 x 2.62	GS	1 1	302534
	Junta entrada de aire	NB	1 1	340636
	Junta entrada de aire	CB	1 1	340837
	O´ring G 75.79 x 3.53	GS	1 1	
	Kit de retenes completo			R340600
	Jgo. retén válvulas (8)	P	1 1	R340610-1P
	Retén bancada 92 x 108 x 9.8	P	1 1	R300311P
	Retén distribución 43.41 x 56.02 x 9.3	P	3 3	R300312P

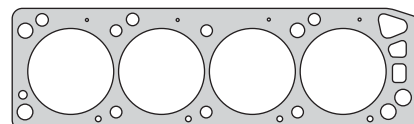

340607

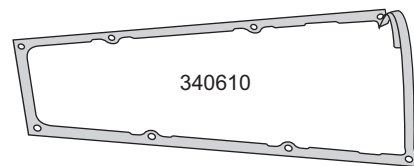

340610

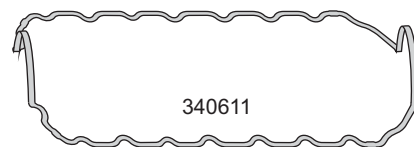

340611



340616-1

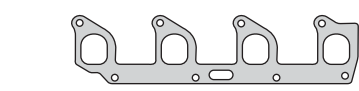

340617

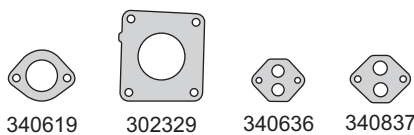

340619

302329

340636

340837



340633



G 26.7 x 2.62



G 75.79 x 3.53



R300311P



R300312P



R340610-1P

FORD

FORD



Motor/Engine **Cm³** **HP** **Ø**

281 CID V8 **4600** **180** **92**

Ford: Town Car 1991/95 - Grand Marquis 1993/95
LTD Crown - Victoria 1992/...
Cougar - Thunderbird 1994/95



Nº OE	Descripción/Description	Mat.			Ref.
	Jgo. de juntas para motor			●	340700-RMX
	Jgo. de juntas superior		●		340795
	Jgo. junta tapa cil. Ø93 \pm 1.30 (2) N.R.	MLS	1	1	340707
	Jgo. junta tapa cil. Ø92 \pm 0.88 (2) N.R.	MLS			340708
	Conj. junta tapa de válvulas (2)	GS	1	1	340710
	Junta para cárter	PLAST		1	340711
	Jgo. cierre distribución (3)	GS	1	1	340712
	Jgo. múltiple escape (2)	NFT	1	1	340715
	Jgo. múltiple admisión (2)	PLAST	1	1	302617
	Base bomba aceite	PLAST		1	340727
	Junta varilla aceite	NFT	1	1	340731
	Cuerpo válvula reguladora	GFT		1	340732
	Entrada aire	CB	1	1	340837
	Placa reguladora aire	CB	1	1	340734
	O´ring G 7.52 x 3.53	GS	16	16	
	O´ring G 101.19 x 3.53	GS		1	
	O´ring G 20.3 x 2.62	GS		1	
	O´ring G 50.39 x 3.53	GS	1	1	
	Kit de retenes completo				R340700
	Jgo. retén válvulas (16)	P	1	1	R340710P
	Retén bancada 92 x 108 x 9.8	P	1	1	R300311P
	Retén distribución 47 x 63.4 x 8.8	P	1	1	R340712P

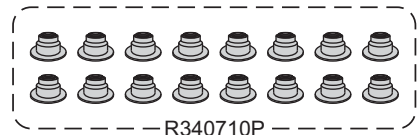
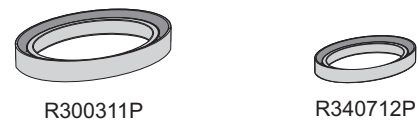
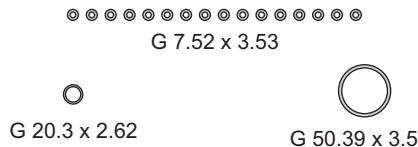
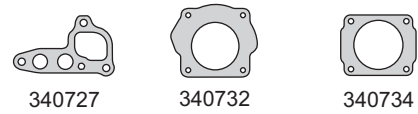
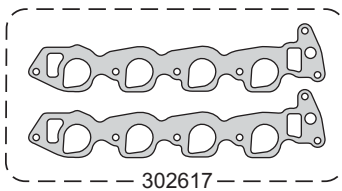
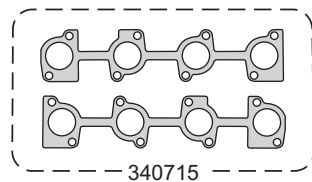
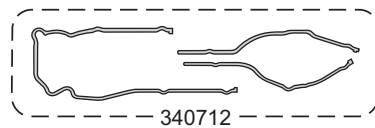
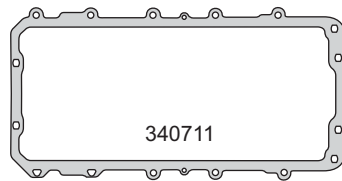
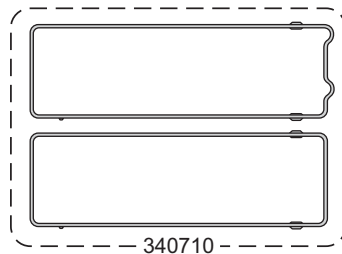
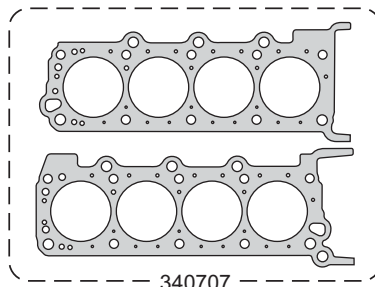

FORD

FORD



Motor/Engine **ZETEC 16V** Cm³ **1989** HP **126** Ø **83**

Ford: Contour 1994/...



Nº OE	Descripción/Description	Mat.	Ref.
	Jgo. de juntas para motor		340800-R
7114447	Junta tapa cilindros Ø 87 ± 1.70	NFT	1 320507
	Jgo. tornillos tapa cilin. (HAT55055/HAT55100)		B320300
1663394	Conj. junta tapa válvulas (11)	GS	1 320310
7008824	Junta para cárter	GS	1 320311
7378788	Frente bomba aceite	CB	1 320312
6691888	Bomba de agua	CB	1 320314
7181761	Múltiple escape	NFT	1 320316
	Múltiple admisión	AL/GS	1 321517
	Junta caja termostato	CB	1 320332
	Junta tapa	SLS	1 340833
1663908	Chupador aceite	CB	1 320334
	Catalizador de gases	NFT	1 340834
7090340	Mariposa gases	CB	1 320335
	Salida de gases	NFT	1 340835
1663861	Bancada trasera	CB	1 320336
	Base termostato	CB	1 340836
6759630	Anillo tapa válvulas G 8.5 x 13.8 x 5	GS	10 320337
	Entrada aire	CB	1 340837
	Sello de agua	GS	1 310940
	Arandela cárter A 15 x 21 x 2 A	AL	1
	O´ring G 7.52 x 3.53	GS	10
	Kit de retenes completo		R320300
	Jgo. retén válvulas (16)	V	1 R320310V
	Retén bancada 88 x 108 x 10	V	1 R320311V
	Retén árbol levas 42 x 53 x 7	V	2 R320313V
	Retén árbol levas 35 x 50 x 7	V	1 R470013V

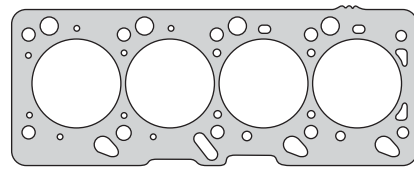

320507

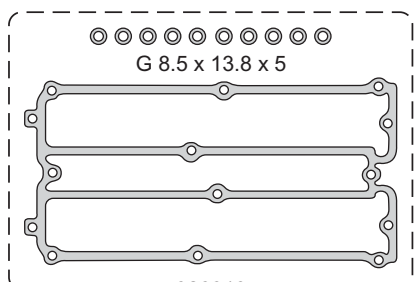

320310

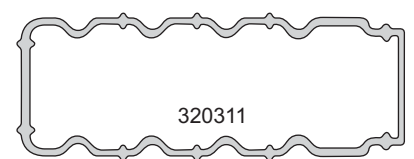

320311



320316

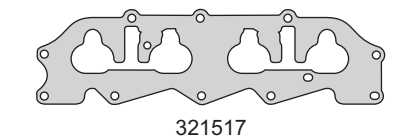

321517

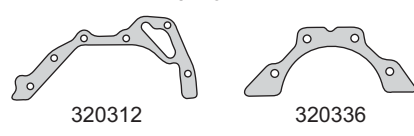

320312

320336

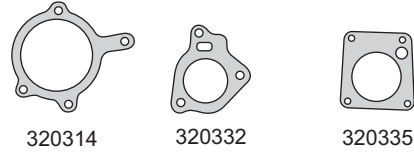

320314

320332

320335

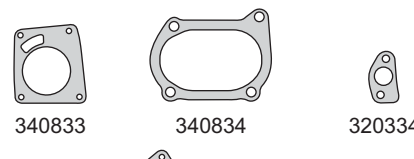

340833

340834

320334

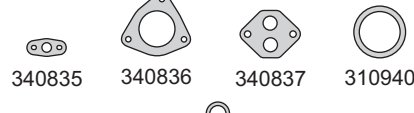

340835

340836

340837

310940

A 15 x 21 x 2 A

G 7.52 x 3.53



R320311V



R470013V



R320313V

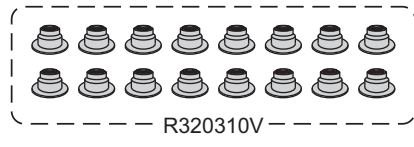

R320310V

FORD

FORD



Motor/Engine	Cm³	HP	Ø
300 CID Inyección	4900	145	101.6

Ford: F100 - 150 1991/...



Nº OE	Descripción/Description	Mat.	Ref.
	Jgo. de juntas para motor		340900-R
	Jgo. de juntas superior		340995
FOUZ-6051-A	Jta. jta. tapa cilin. Ø105.5 ± 1.20	NFT	1 1 340907
	Junta tapa válvulas	GS	1 1 340910
E7TZ-6710B	Junta para cárter	GS	1 1 340911
E6TZ-6020B	Tapa distribución	NB	1 1 340912
C5AZ-8507A	Bomba de agua	NB	1 1 310214
E7TZ-9H486B	Múltiple escape	NFT	1 1 340916
E7TZ-9439A	Múltiple admisión	NB	1 1 340917
E67Z-8255B	Termostato	NB	1 1 340919
E7TZ-9E936B	Válvula mariposa	NB	1 1 340926
E0TZ-6626A	Aspiración bomba de aceite	NB	1 1 340927
E6FZ-90476A	Válvula ERG	NFT	1 1 340929
	Arandela tapa válvulas	GS	6 6 400130
E4TZ-6521A	Junta lateral válvulas	CG	1 1 310236
	Entrada aire	CB	1 1 340837
	Arandela A 67 x 80 x 1.6	CB	1 1 280142
	Arandela A 12.8 x 22.8 x 2	PLAST	1 1
	Arandela tapón cárter A 14 x 18 x 1.5 A	AL	1 1
	O´ring G 28.12 x 3.53	GS	1 1
E8AZ-6571A	Kit de retenes completo		R340900
F1TZ-6701A	Jgo. retén válvulas (12)	P	1 R340910P
E60Z-6700A	Retén bancada 95 x 114.5 x 11	P	1 R340911P
	Retén distribución 47.65 x 65.05 x 12	P	1 R300212P

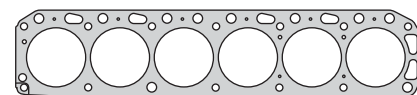

340907

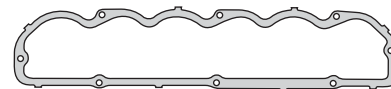

340910

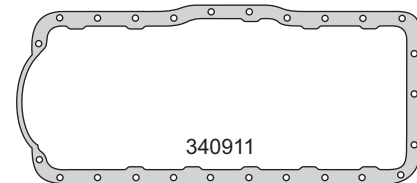

340911



310236



340916

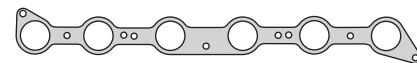

340917

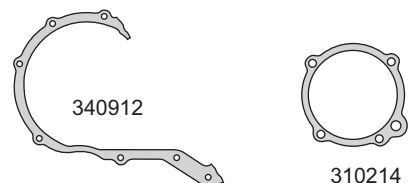

340912

310214



340919

340926

340927



340929

340837

280142



400130



A 14 x 18 x 1.5 A

A 12.8 x 22.8 x 2



G 28.12 x 3.53



R300212P

R340911P

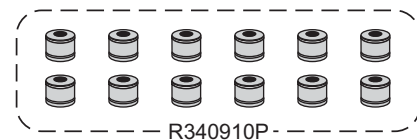

R340910P



taranto



Paso a Paso



Lubricar las roscas y debajo de la cabeza del tornillo

Seguir la especificación Taranto incluida en cada caja de tornillos, generalmente el ajuste inicial se da con torquimetro.

Realizar el apriete final segun lo especificado en la ficha de ajuste. Para la generalidad de los motores modernos el apriete es angular.

RECUERDE... Siempre que se realiza un cambio de Junta y se aprieta la Tapa de Cilindros con un ajuste angular, se deben cambiar los tornillos de fijación, para asegurar así un correcto funcionamiento de la pieza.

Tornillos de Tapa de Cilindros Taranto.

Las consecuencias de NO cambiar los Tornillos de Tapa de Cilindros son más costosas que reemplazarlos. No lo dude!!!

- ▶ Indispensable para el buen funcionamiento del motor.
- ▶ Diseñados para resistir el estiramiento.
- ▶ Resisten altas temperaturas y presiones, característica de los motores modernos de alta performance.



LADA



Motor/Engine **Cm³** **HP** **Ø**

BA3 **1568** **78** **79**

Lada: 2106 - 2107 - 2121 - Niva 2121 1976/...
Aleko 2141 1990/...



Nº OE	Descripción/Description	Mat.	Ref.
	Jgo. de juntas para motor		970500-R
21011-100320	Junta tapa cilindros Ø 81.6 ± 1.40	NFT	1 970505
2101-1003270	Junta tapa válvulas	CG	1 970510
2101-100970	Junta para cárter	CG	1 970511
2101-1002064	Tapa distribución	NB	1 970512
2105-1002064	Placa distribución	NB	1 970513
2101-130746	Tapa bomba de agua	NB	1 970514
2101-1008081	Jgo. múltiple admisión y escape (2)	NFT	1 970516
2101-1305020	Salida de escape	FCH	1 250618
2101-1307048	Placa bomba de agua	NB	1 970519
2101-1107015	Jgo. juntas carburador WEBER 26	VS	970520
2101-1107080	Jgo. juntas carburador SOLEX 26	VS	970521
2108-1107990	Jgo. juntas carburador SOLEX SAMARA 26	VS	970522
	Base carburador	NB	2 970525
2101-1106170	Base bomba nafta	NB	2 250128
2101-1005155	Porta retén bancada trasera	NB	1 250729
2105-1005255	Tapa árbol de levas	NB	1 970530
2101-1011021	Chupador bomba aceite	NB	1 250735
2101-1011020	Base bomba aceite	NB	1 970535
2101-1303017	Carcaza termostato	NB	1 970536
2101-1303038	Caño calefactor	NB	1 970537
	Unión caño escape	NFT	970538
	Kit de retenes completo		R970500
2108-1007026	Jgo. retén válvulas (8)	V	1 R250410V
	Retén bancada 70 x 90 x 10	P	1 R550411P
	Retén distribución 40 x 56 x 7	P	1 R260312P

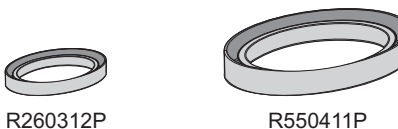
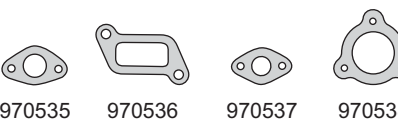
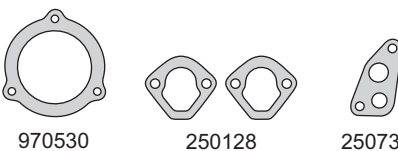
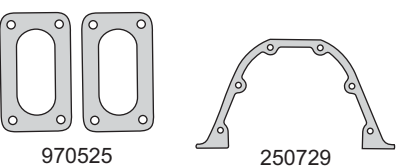
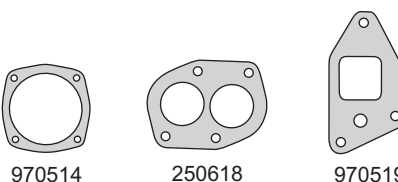
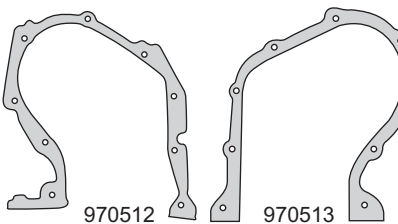
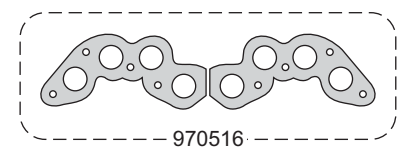
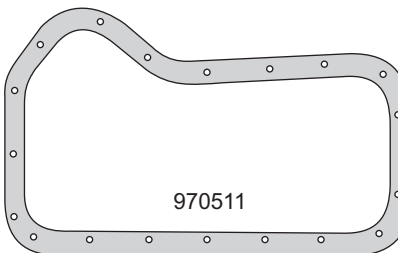
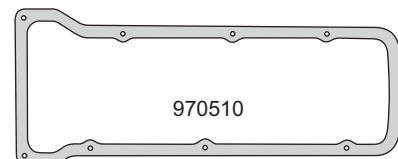
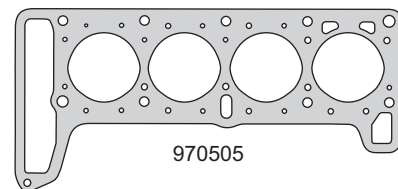

LADA

LADA



Motor/Engine	Cm³	HP	Ø
OHC	1198	60	76
OHC	1452	75	76

Lada: 2101 - 2102 1970/...
2103 - 2107 1972/...



Nº OE	Descripción/Description	Mat.	Ref.
	Jgo. de juntas para motor		970600-R
2101-1003020	Junta tapa cilindros Ø 78.4 ± 1.40	NFT	1 970605
2101-1003270	Junta tapa válvulas	CG	1 970510
2101-1003070	Junta para cárter	CG	1 970511
2101-1002064	Tapa distribución	NB	1 970512
2105-1002064	Placa distribución	NB	1 970513
2101-1307046	Tapa bomba de agua	NB	1 970514
2101-1008081	Jgo. múltiple admisión y escape (2)	NFT	1 970516
2101-1303020	Salida de escape	FCH	1 250618
2101-1307048	Placa bomba de agua	NB	1 970519
	Jgo. juntas carburador weber 2B	VS	970520
2101-1107015	Jgo. juntas carburador SOLEX 2B	VS	970521
2101-1107080	Jgo. juntas carburador SOLEX SAMARA 2B	VS	970522
2108-1107990	Base carburador	NB	2 970525
2101-1106170	Base bomba nafta	NB	2 250128
2101-1005155	Porta retén bancada trasera	NB	1 250729
2105-1005255	Tapa árbol de levas	NB	1 970530
2101-100608	Bomba aceite	NB	1 970535
2101-1011021	Chupador bomba aceite	NB	1 250735
2101-1303017	Carcasa termostato	NB	1 970536
2101-1303038	Caño calefactor	NB	1 970537
	Unión caño escape	NFT	970538
	Kit de retenes completo		R970500
2108-1007026	Jgo. retén válvulas (8)	V	1 R250410V
	Retén bancada 70 x 90 x 10	P	1 R550411P
	Retén distribución 40 x 56 x 7	P	1 R260312P

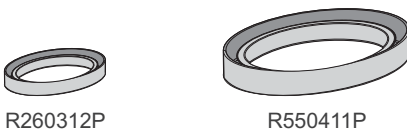
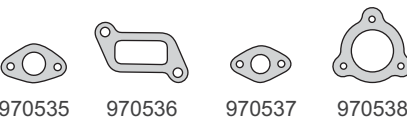
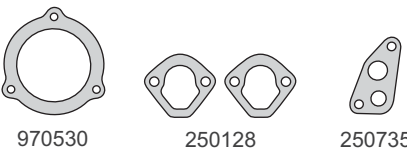
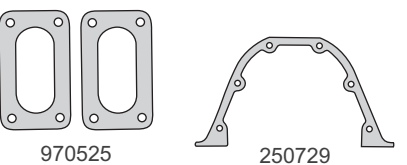
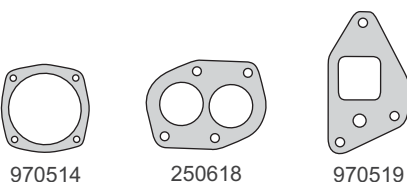
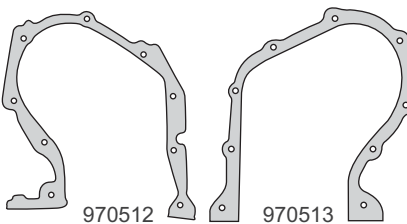
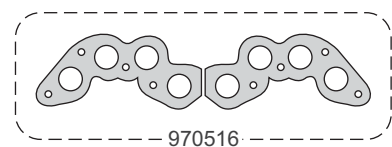
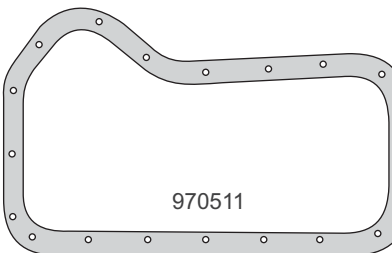
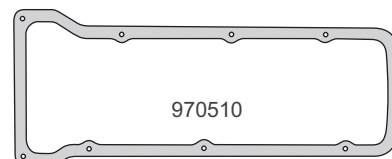
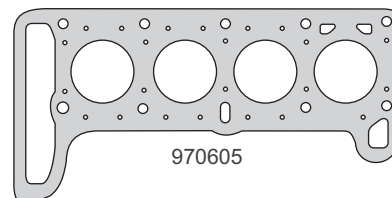

LADA



Motor/Engine **Cm³** **HP** **Ø**

OHC - 17LTBI **1690** **80** **82**

Lada: Vaz 21213 - Niva 21213 1994/...



Nº OE	Descripción/Description	Mat.	Ref.
	Jgo. de juntas para motor		970700-R
21213-1003020	Junta tapa cilindros Ø 83.5 ±1.40	NFT	1 970705
2101-1003270	Junta tapa válvulas	CG	1 970510
2101-100970	Junta para cárter	CG	1 970511
2101-1002064	Tapa distribución	NH	1 970512
2105-1002064	Placa distribución	NH	1 970513
2101-130746	Tapa bomba de agua	NH	1 970514
2101-1008081	Jgo. múltiple admisión y escape (2)	NFT	1 970516
2101-1305020	Salida de escape	FCH	1 250618
2101-1307048	Placa bomba de agua	NH	1 970519
2101-1107015	Jgo. juntas carburador WEBER 26	VS	970520
2101-1107080	Jgo. juntas carburador SOLEX 26	VS	970521
2108-1107990	Jgo. juntas carburador SOLEX SAMARA 26	VS	970522
	Base carburador	NH	2 970525
2101-1106170	Base bomba nafta	NH	2 250128
2101-1005155	Porta retén bancada trasera	NH	1 250729
2105-1005255	Tapa árbol de levas	NH	1 970530
2101-1011021	Chupador bomba aceite	NH	1 250735
2101-1011020	Base bomba aceite	NH	1 970535
2101-1303017	Carcasa termostato	NH	1 970536
2101-1303038	Caño calefactor	NH	1 970537
	Unión caño escape	NFT	970538
	Kit de retenes completo		R970500
2108-1007026	Jgo. retén válvulas (8)	V	1 R250410V
	Retén bancada 70 x 90 x 10	P	1 R550411P
	Retén distribución 40 x 56 x 7	P	1 R260312P

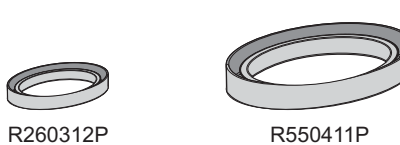
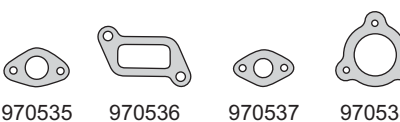
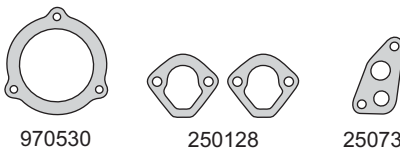
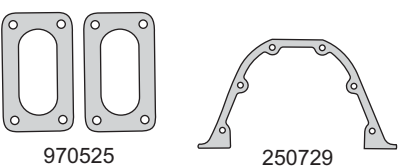
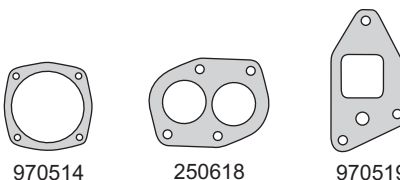
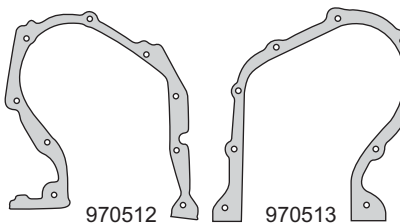
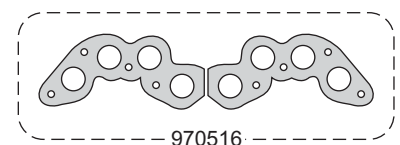
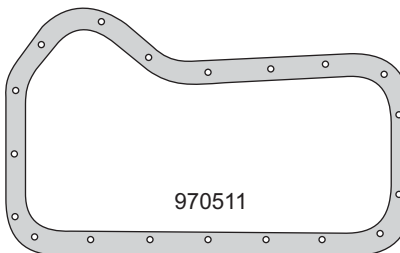
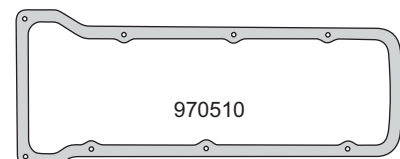
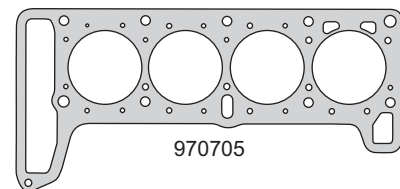

LADA



taranto

INSTRUCCIONES DE MONTAJE

1



Seleccionar el eje piloto para encajar el diámetro interno del retén guía de válvula e insertar.

2



Seleccionar el mandril con el diámetro interno más pequeño que encaja en el retén y montarlo a mano.

3



Deslizar el mandril en el eje piloto e insertar el mismo en la guía de válvulas. Deslizar hacia abajo y luego retirarla la herramienta.



HCRV - Herramienta de Instalación RGV Taranto.





Este dispositivo permite alinear correctamente el retén a la guía de válvula, eliminando así el riesgo de dañar el mismo durante el montaje.

- ▶ Permite instalar el retén de guía de válvulas evitando su caída hacia el interior del cilindro, permitiendo así el recambio del retén sin desmontar la tapa de cilindros.
- ▶ Es aplicable en vehículos nacionales e importados.



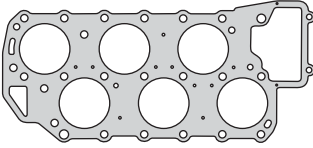
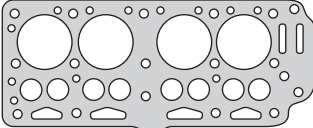
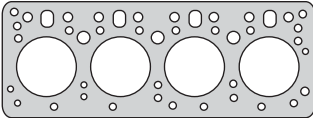

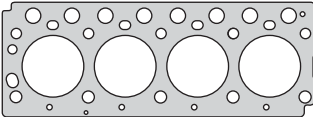
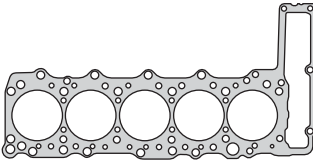
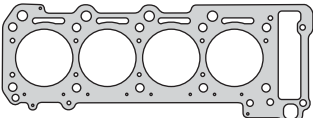
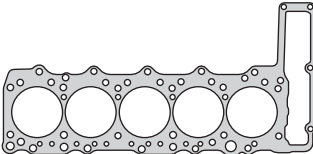
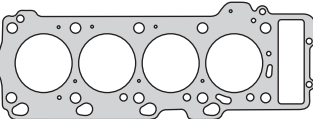
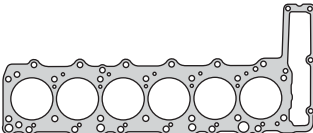







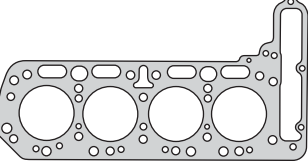



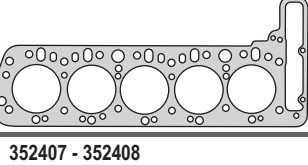



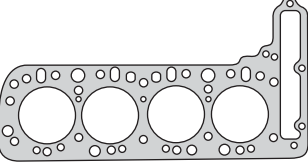

MOTORES NAFTA - DIESEL

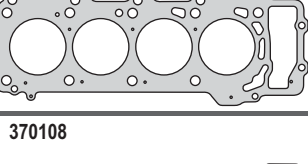
<p>230707</p> 	Código	Ø	⊗	Kit Bulón	Modelo
	230707	83.0	1.60	B230700 (HAN12055)	V280 1998/...
<p>350505</p> 	Código	Ø	⊗	Kit Bulón	Modelo
	350505	77.0	1.70		170DA - 170DB - 170D5 - 170SD - 180D - 180DB - O 319D - L405 - L406
<p>350805 - 350807</p> 	Código	Ø	⊗	Kit Bulón	Modelo
	350805	99.0	1.40	B350100 (HAD19038)	711D - 811D - 609D - 614D - 709D - 809D - OM364 Aspirado 1987/...
	350805-100	100.0	1.40		
	350807	99.0	1.40		
3971cc. OM 364 90/115HP Ø97.5 - DIESEL (350800-R)  pág. 92					
<p>351007 - 351008</p> 	Código	Ø	⊗	Kit Bulón	Modelo
	351007 351008	104.0 103.5	1.30 1.20	B351000 (HAD19038)	Vario 614/814/815/810 - Atego 712/714/715/717/812/814/815/817/917 1017/1214/1215/1217/1317/1517
<p>351107</p> 	Código	Ø	⊗	Kit Bulón	Modelo
	351107	90.0	1.70	B351100 (HAN10055) (HAN10100)	Sprinter T1N 1995/99 - 290 TD - E290 GTD 1994/...
<p>351207 - 351208</p> 	Código	Ø	⊗	Kit Bulón	Modelo
	351207-1M 351207-2M 351208-1M 351208-2M	89.0 89.0 89.0 89.0	1.20 1.40 1.20 1.40	B351200 (HAE18038)	Sprinter 413 CDI 411/413/313/611/981 2000/... - C200-CDI 611.961/960 1998/... - Vito 108/110/112 CDI - Sprinter 208/211/213 CDI 611.980
<p>351307</p> 	Código	Ø	⊗	Kit Bulón	Modelo
	351307	90.0	1.70	B351100 (HAN10055) (HAN10100)	210D - 310D - 410D - G290 - 290 GD 1992/...
<p>351408</p> 	Código	Ø	⊗	Kit Bulón	Modelo
	351408	81.0	1.20		A170 CDI 1998/01 - Vaneo TD 2001/...
<p>351507</p> 	Código	Ø	⊗	Kit Bulón	Modelo
	351507	88.0	1.70	B351100 (HAN10055) (HAN10100)	300 Turbo 1985/93 - E300 Turbo 1993/96 - 300GD 1989/93
					2996cc. OM603.931/950/960/963 143HP Ø87 (351500-R)  pág. 305 DIESEL

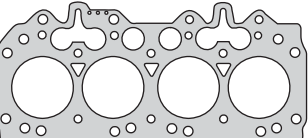

MOTORES NAFTA - DIESEL

	Código 351607	Ø 88.0	 1.95	Kit Bulón B360100 (HAN12055) (HAN12100)	Modelo L307 - 200D - N1300 - MB90 - L307 - MB100 - L406D - L408D - 0309D 306D - 306D6 - 200D - L206 - D61	Motor 1988cc. OM 615 55/60HP Ø87 - DIESEL (351600-R)  pág. 306
	Código 351707	Ø 91.0	 1.70	Kit Bulón	Modelo 190E 1990/93 - 190 1982/84 - 190E 1985/93 - 200 1984/93	Motor 1797cc. MB102.910/919 108HP Ø89 1996cc. MB102.921 90/122HP - MB102.962/922 105/122HP Ø89 (351700-R)  pág. 307
	Código 351807	Ø 92.0	 1.70	Kit Bulón	Modelo 300 GD - 300 GD (4 x 4) - 209D - 309D - 409D - 240D 300D/CD/TD 1974/89	Motor 2998cc. OM 617.910/913/931/932 80/88HP Ø91 (351800-R)  pág. 308 DIESEL
	Código 352407-1M 352707-2M 352408-1M 352708-2M	Ø 90.0 90.0 90.0 90.0	 1.20 1.40 1.20 1.40	Kit Bulón B352400	Modelo E270 CDI, ML270 CDI, CLK270CDI, C270 CDI/G270 CDI, Sprinter CDI 1999/.. - 2002/... - C30 CDI AMG 2002/...	Motor 2685cc. OM612.961/962/963/965/967/981 156/163/170HP Ø88 (DOHC) 20V 2950cc. OM 612.990 231HP Ø88 (DOHC) 20V (352401-R)  pág. 309
	Código 360107	Ø 92.0	 1.70	Kit Bulón B360100 (HAN12055) (HAN12100)	Modelo 240D/TD 1973/... - 207/307/407/507/510D - L406/407DG - 0309D 1977/... 240GD 1976/87 - MB100/200/300/400/180D/150/170	Motor 2404cc. OM 616.912/934/960/916/940/961/963 65/72HP Ø91 DIESEL (360100-R)  pág. 310
	Código 360507	Ø 88.0	 1.70	Kit Bulón B360500 (HAN10055) (HAN10100)	Modelo E200D - C200D - 200D/TD 1984/93 190D 1984/...	Motor 1997cc. MB601.911/912/913 72/75HP Ø87 2197cc. MB601.921 72HP Ø87 - DIESEL (360500-R)  pág. 311
	Código 370008	Ø 81.0	 0.70	Kit Bulón	Modelo Clase 140A 1997/... 160A 1997/... - Vaneo 2001/...	Motor 1397cc. M166.940 82/102HP Ø80 1598cc. M166.961 82/102HP Ø80
	Código 370108	Ø 83.0	 0.90	Kit Bulón	Modelo C180/C160/C200/CLK200 2002/... - E200 2003/... - C230 SLK200 2004/...	Motor 1397cc. M166.940 82/102HP Ø80 1598cc. M166.961 82/102HP Ø80 (370195 MLS)  pág. 312
	Código 430007-1M 430007-2M 430007-3M 430007-4M 430008-1M 430008-2M 430008-3M	Ø 92.0 92.0 92.0 92.0 92.0 92.0 92.0	 1.37 1.48 1.59 1.70 1.30 1.40 1.50	Kit Bulón B430000 (HAS19038)	Modelo Sprinter TDI 1997/...	Motor 2495cc. 95HP Ø90.5 - DIESEL (430001-R)  pág. 314

MERCEDES BENZ



Motor/Engine	Cm³	HP	Ø
OM 636.916/918	1767	40	75
OM 636.919/931	1767	40	75
OM 636.930/934	1767	45	75

Mercedes Benz: 170DA - 170DB - 170D5 - 170SD
180D - 180DB - O 319D
L405 - L406

DIESEL



Nº OE	Descripción/Description	Mat.	Ref.
	Jgo. de juntas para motor		350500
6360160820	Junta tapa cilindros Ø 77 \pm 1.70	NFT	1 350505
6360160180	Junta tapa válvulas superior	CG	1 350510
	Jgo. junta para cárter (2)	NB	1 350511
63601500380	Tapa distribución	NB	1 350512
1360150120	Placa distribución	NB	1 350513
1532010080	Cuerpo bomba de agua	NB	1 350514
6361410179	Jgo. múltiple escape (2)	NFT	1 350516
6361420080	Jgo. múltiple admisión (2)	NB	1 350517
153492181	Salida de escape	CHA	1 350518
6361840480	Tapa filtro aceite	NB	1 350527
6360740480	Acople bomba inyectora	NB	1 350528
6361840380	Acople filtro bomba aceite	NB	1 350529
6360110180	Tapa lateral admisión	NB	1 350530
	Arandela bomba aceite	NB	1 350533
6360150180	Tapa válvulas lateral	CG	1 350536
	Bancada cigüeñal	SNA	1 350558
	Retén distribución 22 x 35 x 10		

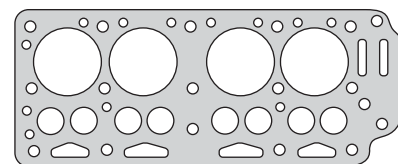

350505

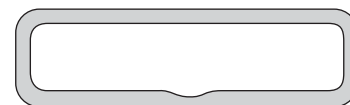

350510

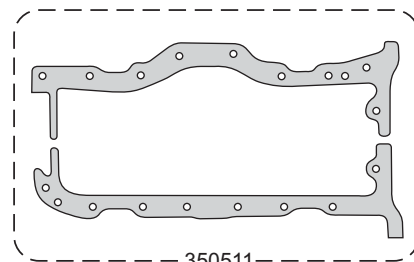

350511

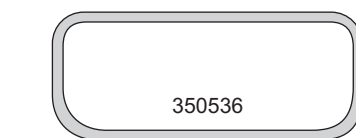

350512

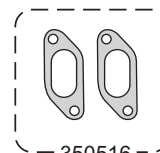

350514

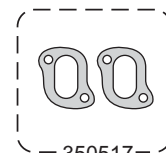

350518

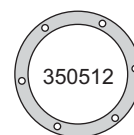

350513

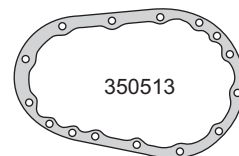

350516



350517



350527



350528



350529



350530



350533



350536



350558

MERCEDES BENZ

MERCEDES BENZ



Motor/Engine	Cm³	HP	Ø
OM 602.983	2874	129	89
OM 602.982	2874	129	89
OM 602.980	2874	122	89
OM 602	2874	120	89

Mercedes Benz: Sprinter T1N 1995/99
290 TD - E290 GTD 1994/...

SsangYong: Korando KJ TDI - Musso MJ TDI 1997/...



DIESEL

Nº OE	Descripción/Description	Mat.	Ref.
	Jgo. de juntas para motor	●	351100-R
6020163920	Junta tapa cilindros Ø 90 \pm 1.70	NFT	1 351107
	Jgo. tornillos tapa cil. (HAN10055/HAN10100)		B351100
6020160221	Junta tapa válvulas	GS	1 351110
6120140122	Junta para cárter	NB	1 351111
	Tapa bomba de agua	NB	1 351114
6021420080	Múltiple escape	AC	1 351115
6021410880	Múltiple admisión	NB	1 351117
	Soporte bomba de agua	NB	1 351119
	Soporte bomba de agua	NH	351119-1
	Base soporte filtro de aceite	NB	1 351129
6612034132	Entrada agua a tapa de cilindros	NB	1 360530
	Base depresora a distribución	NH	1 351131
6050140122	Junta para cárter inferior	NB	1 351132
	Guarnición tapón aceite	GS/AC	351133
	Arandela pico inyector	AL	5 320046
	Arandela A 12 x 15 x 1.5 A	AL	
	Arandela A 22 x 28 x 1.25 A	AL	4
	Arandela A 27 x 32 x 2 A	AL	
	Arandela A 25 x 30 x 2 A	AL	
	Arandela A 10 x 13.8 x 1 A	AL	
	Arandela A 18.5 x 22 x 1.5 A	AL	
	Arandela A 14 x 18 x 1.25 A	AL	1
	Arandela A 14.5 x 20 x 1.5 C	CU	
	Arandela A 7 x 15 x 1.5 C	CU	
	Arandela A 10 x 13.3 x 1 A	AL	
	O´ring G 8 x 2	GS	
	O´ring G 17.04 x 3.53	GS	1
	O´ring G 38 x 3	GS	
	O´ring G 75 x 3	GS	
	O´ring G 35 x 2	GS	
	O´ring G 42 x 4	GS	1
	Kit de retenes completo		R351300
	Jgo. retén válvulas (10)	V	1 R351310V
0179977447	Retén bancada 93 x 114 x 13	V	1 R351111V
0219977647	Retén distribución 45 x 67 x 8	V	1 R351112V

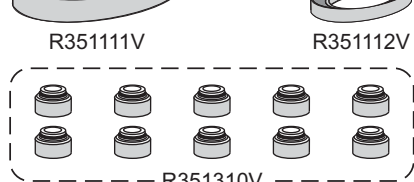
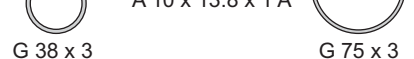
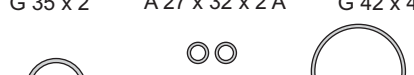
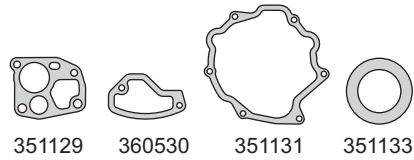
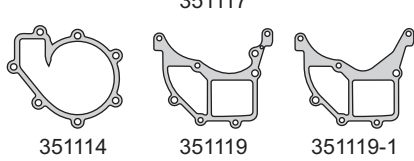
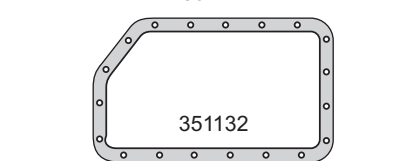
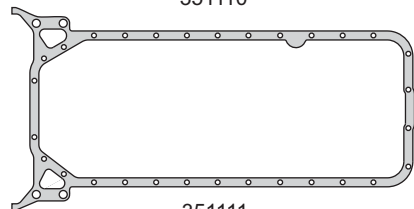
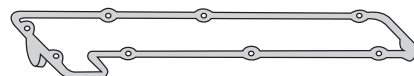
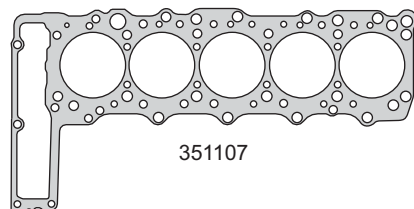

MERCEDDES BENZ

**MERCEDES
BENZ**



Motor/Engine	Cm³	HP	Ø
OM611 CDI 611.960/961/980 Iny. Directa 16V	2151	100/125	88

Mercedes Benz: Sprinter 413 CDI
411/413/313/611/981 2000/...
C200-CDI 611.960/961 1998/...
Vito 108/110/112 CDI
Sprinter 208/211/213 CDI
611.980



DIESEL

Nº OE	Descripción/Description	Mat.	Ref.
6110104520	Jgo. de juntas para motor		351201-R
	Jgo. de juntas superior		351295-1M
	Jgo. de juntas superior		351295-2M
	Junta tapa cilindros Ø 89 ±1.20	NFT 1	351207-1M
	Junta tapa cilindros Ø 89 ±1.40	NFT	351207-2M
6110160520	Junta tapa cilindros Ø 89 ±1.20	MLS	351208-1M
6110160920	Junta tapa cilindros Ø 89 ±1.40	MLS	351208-2M
910143008011	Jgo. tornillos tapa cilindros (HAE18038)		B351200
6110160121	Jgo. junta tapa válvulas (9)	GS 1 1	351210
6110140222	Junta para cárter	NFT 1	351211
6112010280	Bomba de agua	SLS 1	351214
6111420380	Múltiple escape	AC 1 1	351215
6110980380	Múltiple admisión	SLS 1 1	351217
6112030380	Guarnición base termostato	GS 1 1	351219
6110160221	Guarnición protección bujías	GS 4 4	351231
	Arandela tapa válvulas	GS 4 4	351232
6110980180	Guarnición colector admisión	GS 1 1	351233
6110980280	Jgo. cierre colector admisión (4)	GS 1 1	351234
6110980380	Jgo. entre colectores inferior (4)	GS 1 1	351235
	Jgo. múltiple admisión entre múltiples (8)	GS 1 1	351237
	O´ring G 44 x 3	GS 1 1	
	Arandela pico inyector A 8 x 14 x 1.5 C	CU 4 4	
	Arandela A 15 x 20 x 1 C	CU 1 1	
	Kit de retenes completo		R351200
6120500058	Jgo. retén válvulas (16)	V 1	R351210V
6110100114	Porta retén bancada trasero	T	PR351211T
0219977647	Retén distribución 45 x 67 x 8	V 1	R351112V

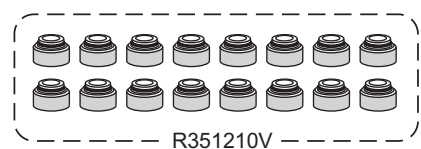
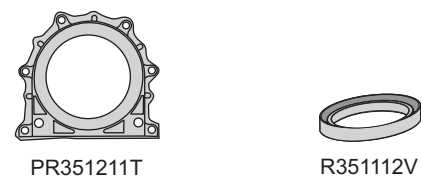
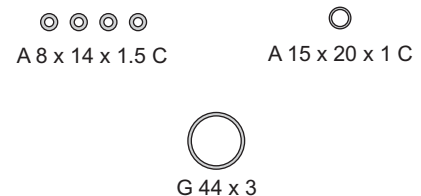
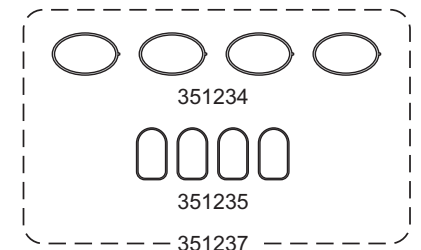
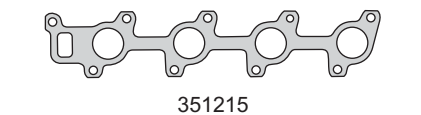
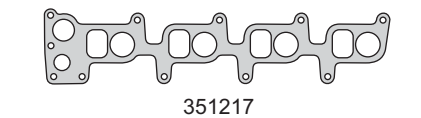
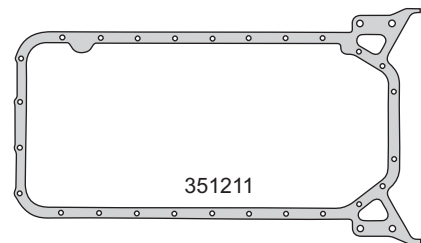
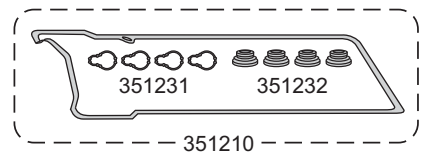
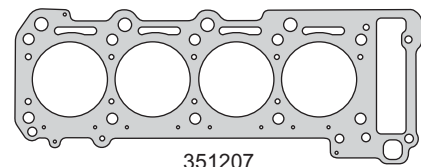

MERCEDES BENZ

MERCEDES BENZ



Motor/Engine	Cm³	HP	Ø
OM 602.940	2874	95	89
OM 602.942	2874	95/98	89
OM 602.947	2874	98	89
OM 602	2874	95	89

Mercedes Benz: 210D - 310D - 410D - G290
290 GD 1992/...

SsangYong: Korando KJ 1996/....
Musso MJ 1995/...

DIESEL



Nº OE	Descripción/Description	Mat.	Ref.
	Jgo. de juntas para motor		351300-R
	Junta tapa cilindros Ø 90 \pm 1.70	NFT 1	351307
	Jgo. tornillos tapa cilin. (HAN10055/HAN10100)		B351100
6020160321	Junta tapa válvulas	GS 1	351310
6120140122	Junta para cárter	NB 1	351111
	Tapa bomba de agua	NB 1	351114
6021420080	Múltiple escape	AC 1	351115
6021410880	Múltiple admisión	NB 1	351117
	Soporte bomba de agua	NB 1	351119
	Soporte bomba de agua	NB	351119-1
	Base soporte filtro de aceite	NB 1	351129
6612034132	Entrada agua a tapa de cilindros	NB 1	360530
	Base depresora a distribución	NB 1	351131
	Junta para cárter inferior	NB 1	351132
	Guarnición tapón aceite	GS	351133
	Arandela pico inyector A 7.8 x 20 x 2.6	AC 5	320046
	Arandela A 12 x 15 x 1.5 A	AL	
	Arandela A 22 x 28 x 1.25 A	AL 4	
	Arandela A 27 x 32 x 2 A	AL	
	Arandela A 25 x 30 x 2 A	AL	
	Arandela A 10 x 13.8 x 1 A	AL	
	Arandela A 18.5 x 22 x 1.5 A	AL	
	Arandela A 14 x 18 x 1.25 A	AL 1	
	Arandela A 14.5 x 20 x 1.5 C	CU	
	Arandela A 10 x 13.8 x 1 A	AL	
	O´ring G 8 x 2	GS	
	O´ring G 17.04 x 3.53	GS 1	
	O´ring G 38 x 3	GS	
	O´ring G 75 x 3	GS	
	O´ring G 35 x 2	GS	
	O´ring G 42 x 4	GS 1	
	Kit de retenes completo		R351300
	Jgo. retén válvulas (10)	V 1	R351310V
0179977447	Retén bancada 93 x 114 x 13	V 1	R351111V
0219977647	Retén distribución 45 x 67 x 8	V 1	R351112V

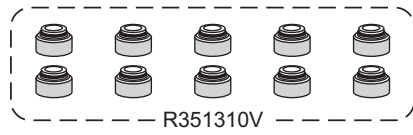
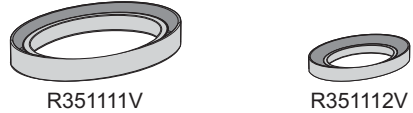
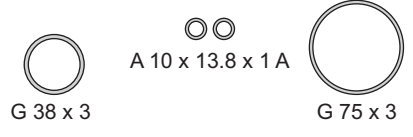
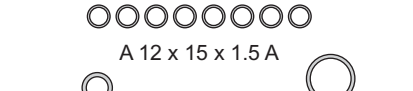
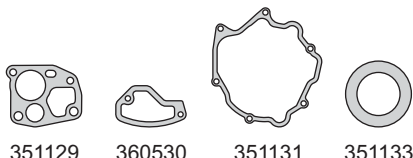
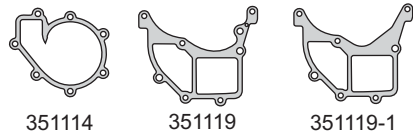
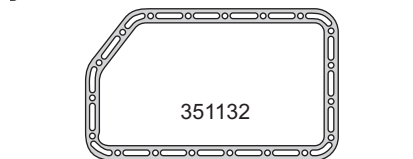
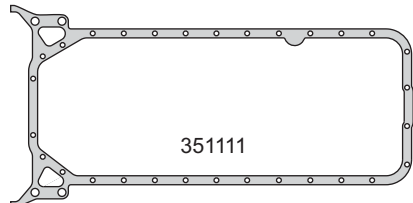
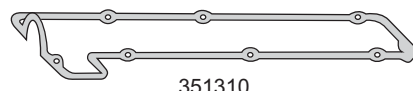
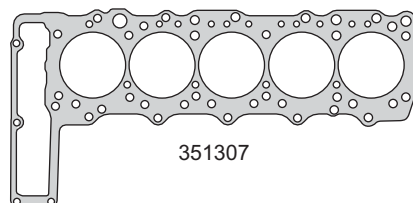

MERCEDDES BENZ

MERCEDES BENZ



Motor/Engine	Cm³	HP	Ø
OM 603.931 OM 603.950 OM 603.960 OM 603.963	2996	143	87
DIESEL			

Mercedes Benz: 300 Turbo 1985/93
E300 Turbo 1993/96
300GD 1989/93



Nº OE	Descripción/Description	Mat.	Ref.
	Jgo. de juntas para motor		351500-R
6020163920	Junta tapa cilindros Ø 88 \pm 1.70	NFT	1 351507
	Jgo. tornillos tapa cilin. (HAN10055/HAN10100)		B351100
6020160221	Junta tapa válvulas	GS	1 351510
6120140122	Junta para cárter	NB	1 351511
6021420080	Múltiple escape	NFT	1 351515
6021410880	Múltiple admisión	NB	1 351517
	Soporte bomba de agua	NB	1 351119
	Base soporte filtro de aceite	NB	1 351529
	Entrada agua a tapa de cilindros	NB	1 351130
	Base depresora a distribución	NB	1 351131
	Jgo. de arandelas pico inyector (6)	CU	1 320044
	O'ring G 73.5 x 2.75	GS	1
	O'ring G 17 x 3.75	GS	2
	O'ring G 36 x 1.50	GS	1
	O'ring G 38 x 3	GS	1
	O'ring G 8 x 2	GS	2
	Arandela A 22 x 28 x 1.25 A	AL	5
	Anillo G 38.5 x 57 x 2.6	GS	1
	Arandela A 25 x 30 x 2 A	AL	2
	Arandela A 18 x 21.5 x 1.5 A	AL	1
	Arandela A 10 x 13 x 1 A	AL	1
	Arandela A 14 x 17.8 x 1.3 A	AL	1
	Arandela A 12 x 15 x 1.5 A	AL	8
	Arandela A 10 x 14 x 1 A	AL	2
	Arandela A 20 x 15 x 1.5 C	CU	1
	Kit de retenes completo		R351300
	Jgo. retén válvulas (12)	V	1 R351310V
0179977447	Retén bancada 93 x 114 x 13	V	1 R351111V
0219977647	Retén distribución 45 x 67 x 8	V	1 R351112V

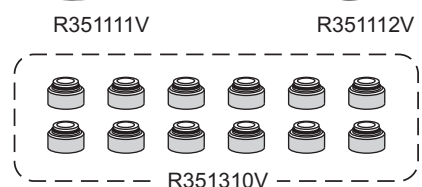
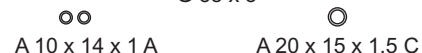
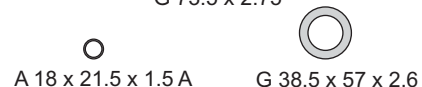
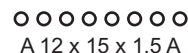
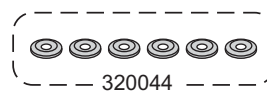
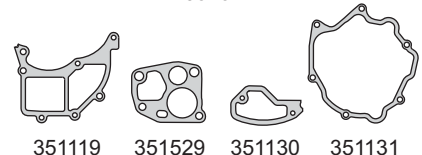
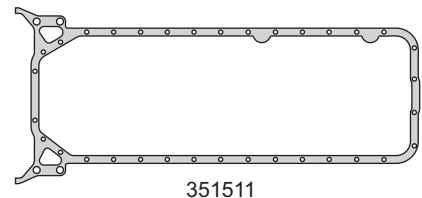
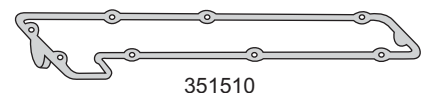
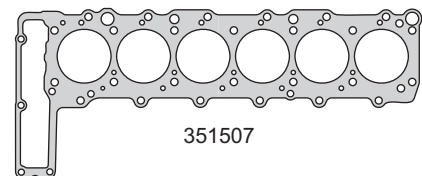

MERCEDDES BENZ

MERCEDES BENZ



Motor/Engine	Cm ³	HP	Ø
OM 615	1988	55/60	87

Mercedes Benz: L307 - 200D - N1300 - MB90
L307 - MB100 - L406D - L408D
0309D 306D - 306D6 - 200D
L206 D61

Seat: 131 - 132

DIESEL



Nº OE	Descripción/Description	Mat.	Ref.
	Jgo. de juntas para motor		351600-R
	Junta tapa cilindros Ø 88 ± 1.95	NFT 1	351607
	Jgo. tornillos tapa cilin. (HAN12055/HAN12100)		B360100
	Sellador líquido - caucho de silicona		TRN0280R
	Junta tapa válvulas	N 1	360110
	Múltiple admisión y escape	NFT 1	360116
	Base filtro aceite	NB 1	360128
	Intercambiador	NB 1	360129
	Bomba hidráulica	NB 1	360130
	Bomba vacío	NB 2	360131
	Tapa termostato	NB 1	360132
	Tensor hidráulico	NB 1	360133
	Acople termostato	NB 1	360134
	Junta	NB 1	360135
	Cuerpo aceite	NB 1	360137
	Junta	NB 1	360138
	Junta	NB 1	360139
	Junta	NB 1	360140
	Retén cigüeñal	SNA 1	360158
	O´ring G 25.07 x 2.62	GS 1	
	O´ring G 7.65 x 1.78	GS 1	
	Arandela A 26 x 32 x 1.5 C	AL 1	
	Arandela A 27 x 32 x 1.5 C	CU 6	
	Kit de retenes completo		R360100
	Jgo. retén válvulas (8)	P 1	R360110P
	Retén distribución 45 x 74.5/79 x 12/14.5	P 1	R360112P

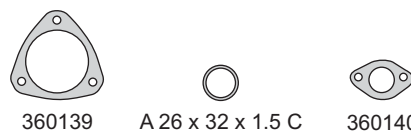
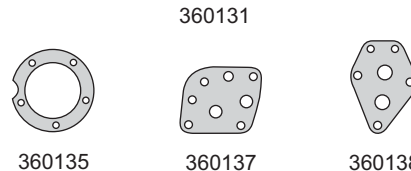
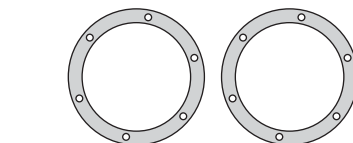
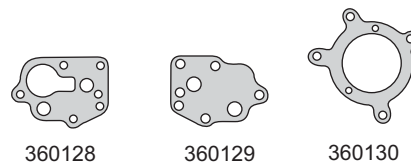
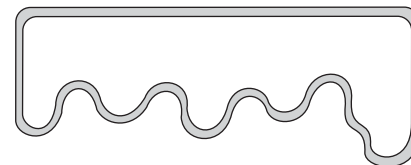
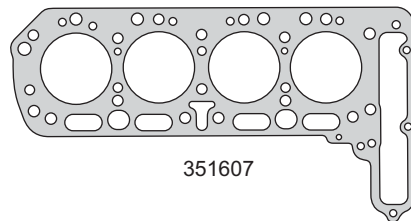

MERCEDES BENZ



Motor/Engine	Cm³	HP	Ø
MB102.910/919	1797	108	89
MB102.921	1996	90/122	89
MB102.962/922	1996	105/122	89

Mercedes Benz: 190E 1990/93
190 1982/84 - 190E 1985/93
200 1984/93



Nº OE	Descripción/Description	Mat.	Ref.
1020162328	Jgo. de juntas para motor	●	351700-R
1020161221	Junta tapa cilindros Ø 91 ±1.70	NFT	1 351707
1020140722	Junta tapa válvulas	GS	1 351710
	Junta para cárter	NH	1 351711
	Tapa distribución	NH	1 351712
	Bomba de agua	NB	1 351714
	Jgo. múltiple escape (5)	VS	1 351715
1021412780	Múltiple admisión	NFT	1 351717
	Múltiple admisión	AC	1 351717-1
	Base termostato	NB	1 351719
	Bomba nafta	NB	1 351728
	Junta	GS	1 351733
	Junta	NB	1 351734
	Junta	NB	1 351735
	Junta	NB	1 351740
	Junta	NB	1 351741
	Arandela A 10.3 x 13.8 x 1 A	AL	3
	Arandela A 14.3 x 17.8 x 1.34 A	AL	4
	Arandela A 27.8 x 31.7 x 2 A	AL	1
	Arandela A 22.4 x 27 x 1.36 A	AL	1
	Arandela A 18.4 x 24 x 1.36 A	AL	1
	Arandela A 14.4 x 19.82 x 1.90 A	AL	1
	Arandela A 12 x 16.8 x 1.39 C	CU	2
	Arandela A 14.45 x 19.8 x 1.36 C	CU	1
	Arandela A 8.4 x 11.8 x 0.82 C	CU	2
	O´ring G 42 x 4.5	GS	1
	O´ring G 30 x 2.6	GS	2
	O´ring G 37 x 2	GS	1
	O´ring G 39 x 2.9	GS	1
	O´ring G 18.4 x 5	GS	1
	O´ring G 12 x 2	GS	1
	Kit retenes completo		R360500
1020500158	Jgo. retén válvulas (8)	V	1 R360510V
0179977447	Retén de bancada 93 x 114 x 13	V	1 R351111V
1209970346	Retén distribución 45 x 67 x 8	V	1 R351112V

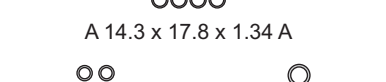
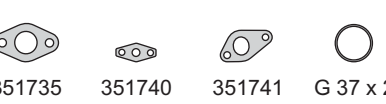
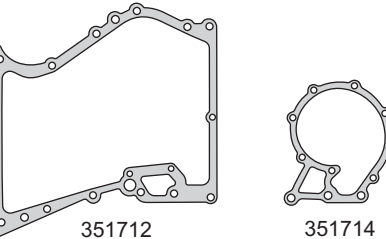
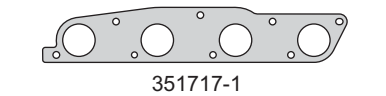
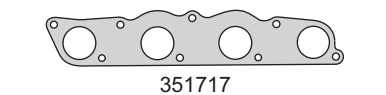
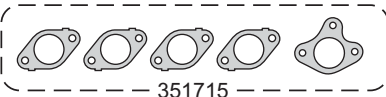
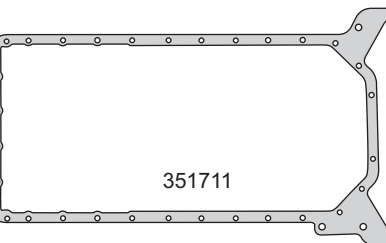
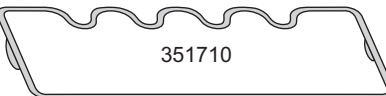
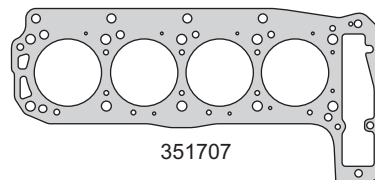

MERCEDDES BENZ

MERCEDES BENZ



Motor/Engine	Cm ³	HP	Ø
OM 617.910	2998	88	91
OM 617.913	2998	80	91
OM 617.931	2998	88	91
OM 617.932	2998	88	91

Mercedes Benz: 300 GD - 300 GD (4 x 4)
209D - 309D - 409D - 240D
300D/CD/TD 1974/89

DIESEL



Nº OE	Descripción/Description	Mat.	Ref.
	Jgo. de juntas para motor		351800-R
	Junta tapa cilindros Ø 92 ± 1.70	NFT 1	351807
	Junta tapa válvulas	GS 1	351010
	Junta para cárter	NH 1	351811
	Tubo de escape	NFT 1	351818
	Base termostato	NH 1	351819
	Base termostato	NH 1	351620
	Bomba hidráulica	NH 1	351621
	Base filtro aceite	NH 1	360128
	Bomba hidráulica	NH 1	360130
	Bomba vacío	NH 1	360131
	Termostato	NH 1	360132
	Arandela pico inyector	CU 5	351833
	Bomba aceite	NH 1	351837
	Aspiración admisión	NH 1	351838
	Acople admisión	NH 1	360139
	Brida retorno aceite	NH 1	360140
	O´ring tapón aceite G 105 x 4	GS 1	
	O´ring G 60 x 3.53	GS 1	
	O´ring G 10 x 2	GS 1	
	O´ring G 12 x 2	GS 1	
	O´ring G 7.5 x 1.83	GS 1	
	O´ring G 4 x 1.63	GS 1	
	O´ring G 26 x 2.63	GS 1	
	Arandela A 37 x 32 x 2 A	AL 1	
	Arandela A 11 x 8 x 1 A	AL 5	
	Arandela A 11 x 8 x 1 C	CU 4	
	Arandela A 15 x 12 x 1.30 A	AL 6	
	Arandela A 17.9 x 14.3 x 1.50 A	AL 2	
	Arandela A 13.8 x 8.2 x 1 A	AL 1	
	Arandela A 16.9 x 12 x 1.60 A	AL 1	
	Arandela A 43.8 x 38 x 2 A	AL 4	
	Arandela A 36 x 30 x 2 A	AC 5	
	Arandela A 28.8 x 24 x 2 A	AL 1	
	Arandela A 24 x 18.2 x 1.30 A	AC 2	
	Arandela A 21.8 x 18 x 1.30 A	AL 3	
	Arandela A 19.9 x 14 x 1.80 A	AL 3	
	Arandela A 17.9 x 14.3 x 1.5 C	CU 8	
	Arandela A 32.2 x 28 x 1.80 C	CU 5	
	Arandela A 30.9 x 26.3 x 2.30 C	CU 1	
	Arandela A 16.85 x 12.3 x 1.50 C	CU 1	
	Arandela A 17.9 x 14.3 x 1.30 A	AL 10	
	Arandela A 30.7 x 26.5 x 1.82	AC 1	
	Retén cigüeñal	SNA 1	360158
	Kit de retenes completo		R351800
	Jgo. retén válvulas (10)	V 1	R351810V
	Retén distribución 45 x 74.5/79 x 12/14.5	V 1	R360112V

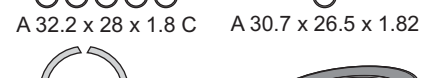
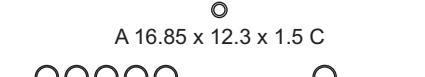
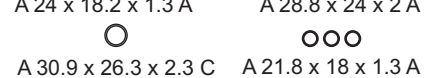
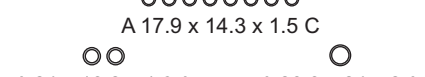
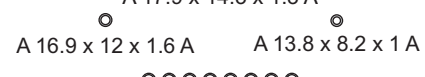
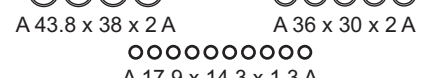
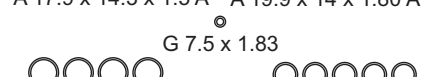
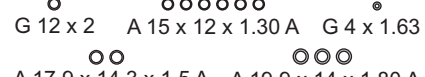
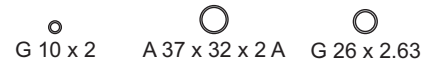
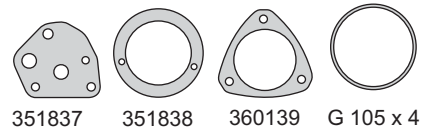
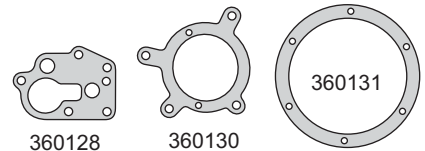
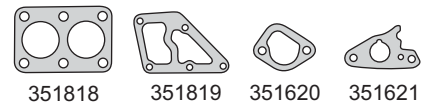
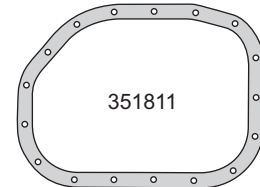
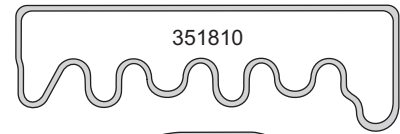
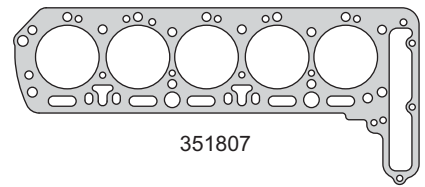

MERCEDDES BENZ

MERCEDES BENZ



Motor/Engine	Cm³	HP	Ø
OM612.961/962	2685	163/170	88
963/965/967/981	2685	156/163	88
ENF	2685	163	88
OM 612.990 (DOHC 20V)	2950	231	88

Jeep: Grand Cherokee TD 2002/...

Mercedes Benz: E270 CDI - ML270 CDI 1999/...
 CLK270CDI - C270 CDI 2000/...
 G270 CDI - Sprinter CDI 2000/...
 C30 CDI AMG 2002/...



DIESEL

Nº OE	Descripción/Description	Mat.	Ref.
	Jgo. de juntas para motor		352401-R
	Jgo. de juntas superior		352495
6460160620	Jta. tapa de cilindro Ø 90 \pm 1.20	NFT	352407-1M
6460160720	Jta. tapa de cilindro Ø 90 \pm 1.40	NFT	352407-2M
6460160680	Jta. tapa de cilindro Ø 90 \pm 1.20	MLS	352408-1M
6460160720	Jta. tapa de cilindro Ø 90 \pm 1.40	MLS	352408-2M
6119901022	Jgo. de tornillos para tapa de cilindros		B352400
6470160121	Jgo. junta tapa válvulas (5)	GS	1 1 352410
6120140122	Junta para cárter	NB	1 352411
6112011280	Bomba de agua	SLS	1 351214
6171420380	Múltiple escape	MLS	1 1 352415
6121410180	Múltiple admisión	SLS	1 1 352417
6461420080	Salida de escape a turbo	SLS	351218
6112030380	Guarnición base termostato	GS	1 1 351219
6460161321	Guarnición protección bujías	GS	5 5 351231
	Arandela tapa válvulas	GS	5 5 351232
6460160281	Enfriador aceite	GS	352432
6110940080	Jgo. colector admisión (5) 1999/05	GS	1 1 352435
6111840280	Enfriador aceite	GS	1 352436
	Varilla aceite	SLS	352437
	Guarnición llenado aceite 47 x 62 x 2.3	GS	352438
	Guarnición conductores 26 x 13 x 1.5	GS	352439
	O´ring G 28 x 2	GS	1
	O´ring G 44 x 3	GS	1
	O´ring G 37.77 x 2.62	GS	2
	O´ring G 32.2 x 2.2	GS	
	O´ring G 16 x 2.5	GS	1
	O´ring G 7.59 x 2.62	GS	1
	Arandela pico inyector A 8 x 15 x 1.5 C	CU	1 1
	Arandela tapón cárter A 27 x 32 x 2 A	AL	
	Arandela A 10 x 15 x 1 C	CU	
	Arandela A 14.3 x 20 x 1.3 C	CU	
	Arandela A 12 x 18 x 1.5 A	AL	1
	Kit de retenes completo		R352400
6120500058	Jgo. retén válvulas (20)	V	1 R352410V
6110100214	Porta retén bancada trasero	V	PR351211V
0219977647	Retén distribución 45 x 67 x 8	V	1 R351112V

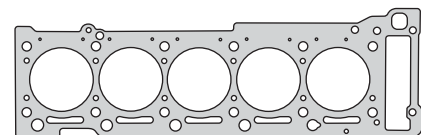

352408

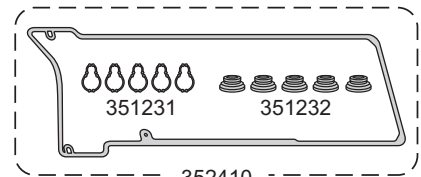

352410

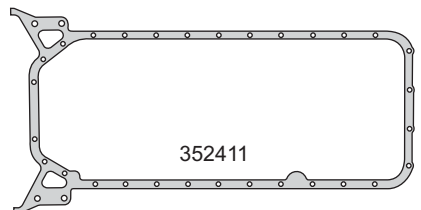

352411



352415



352417

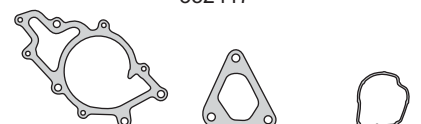

351214

351218

351219

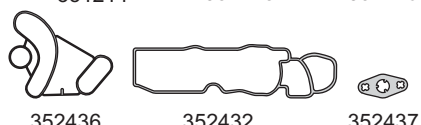

352436

352432

352437



352435



352438

352439

352439

G 32.2 x 2.2



G 37.77 x 2.62

G 44 x 3

G 7.59 x 2.62



G 16 x 2.5

A 27 x 32 x 2 A

G 28 x 2

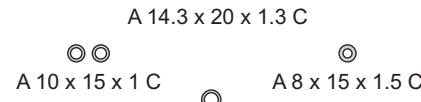

A 14.3 x 20 x 1.3 C

A 10 x 15 x 1 C

A 8 x 15 x 1.5 C

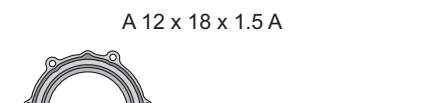

A 12 x 18 x 1.5 A

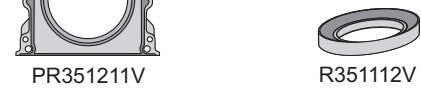

PR351211V

R351112V



R352410V

MERCEDES BENZ

MERCEDES BENZ



Motor/Engine	Cm ³	HP	Ø
OM 616.912	2404	65	91
OM 616.934/960	2404	65	91
OM 616.916/940	2404	72	91
OM 616.961/963	2404	72	91

Mercedes Benz: 240D/TD 1973/... - 207/307D
 407/507/510D - L406/407DG
 0309D 1977/... - 240GD 76/87
 MB100/200/300/400/180D
 MB150/170



DIESEL

Nº OE	Descripción/Description	Mat.	Ref.
	Jgo. de juntas para motor		360100-R
6210100321	Junta tapa cilindros Ø 92 ± 1.70	NFT 1	360107
	Jgo. tornillos tapa cilin. (HAN12100/HAN12055)		B360100
6150160080	Junta tapa válvulas	N 1	360110
	Jgo. junta para cárter (3)	NB 1	360111
6211421180	Múltiple admisión y escape	NFT 1	360116
	Base filtro aceite	NB 1	360128
	Intercambiador	NB 1	360129
	Bomba hidráulica	NB 1	360130
	Bomba vacío	NB 2	360131
	Termostato	NB 1	360132
	Tensor hidráulico	NB 1	360133
	Acople termostato	NB 1	360134
	Junta	NB 1	360135
	Cuerpo aceite	NB 1	360137
	Junta	NB 1	360138
	Junta	NB 1	360139
	Junta	NB 1	360140
0019971241	Retén cigüeñal	SNA 1	360158
	Arandela A 28 x 34 x 1.5 A	AL 4	
	Arandela A 26 x 32 x 2 A	AL 2	
	Arandela A 14 x 18 x 1.5 A	AL 1	
	O'ring G 25.07 x 2.62	GS 1	
	O'ring G 7.59 x 2.62	GS 1	
	O'ring G 6.07 x 1.78	GS 2	
	Kit de retenes completo		R360100
	Jgo. retén válvulas (8)	P 1	R360110P
0119972247	Retén distribución 45 x 74.5/79.5 x 12/14.5	P 1	R360112P

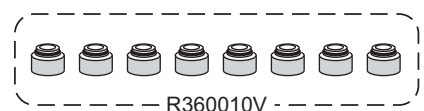
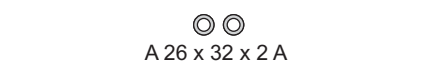
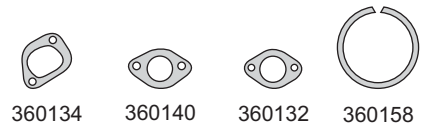
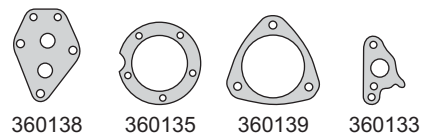
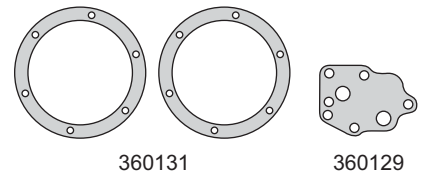
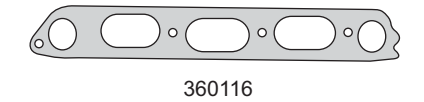
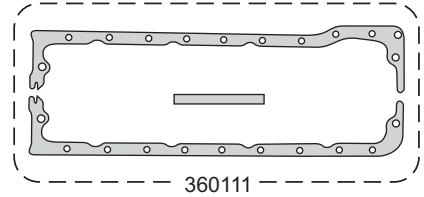
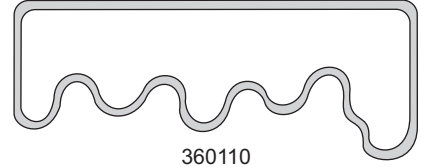
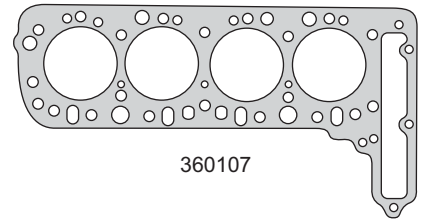

MERCEDES BENZ

**MERCEDES
BENZ**



Motor/Engine	Cm³	HP	Ø
OM 601.911/912	1997	72/75	87
OM 601.913	1997	72/75	87
OM 601.921	2197	72	87

Mercedes Benz: E200D - C200D - 200D/TD
190D 1984/93

DIESEL



Nº OE	Descripción/Description	Mat.	Ref.
	Jgo. de juntas para motor		360500-R
	Junta tapa cilindros Ø 88 ±1.70	NFT	1 360507
	Jgo. tornillos tapa cilin. (HAN10055/HAN10100)		B360500
	Junta tapa de válvulas	GS	1 360510
	Junta para cárter	NB	1 360511
	Múltiple escape	GFT	1 360515
	Múltiple admisión	NFT	1 360517
	Soporte bomba de agua	NFT	1 351119
	Soporte bomba de agua	NH	1 351119-1
	Base soporte filtro de aceite	NH	1 351129
	Junta entrada agua a tapa cilindros	NH	1 351130
	Base depresora a distribución	NH	1 351131
	Guarnición tapón aceite	GS	1 351133
	Arandela A 12 x 15 x 1.5 A	AL	8
	Arandela A 22 x 27 x 1.5 A	AL	3
	Arandela A 27 x 32 x 2 A	AL	1
	Arandela A 25 x 30 x 2 A	AL	1
	Arandela A 10 x 13.8 x 1 A	AL	2
	Arandela A 14 x 20 x 2 A	AL	1
	Arandela A 18.5 x 22 x 1.5 A	AL	1
	Arandela A 12 x 17 x 1.5 C	CU	1
	Arandela A 14.5 x 20 x 1.5 C	CU	1
	O´ring G 8 x 2	GS	1
	O´ring G 17 x 4	GS	1
	O´ring G 38 x 3	GS	1
	O´ring G 75 x 3	GS	1
	O´ring G 35 x 2	GS	1
	Kit de retenes completo		R360500
	Jgo. retén válvulas (8)	V	1 R360510V
	Retén bancada 93 x 114 x 13	V	1 R351111V
	Retén distribución 45 x 67 x 8	V	1 R351112V

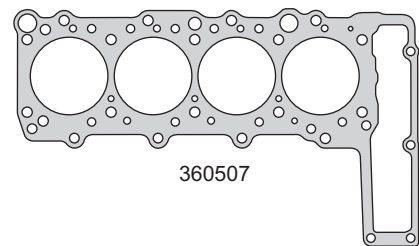

360507

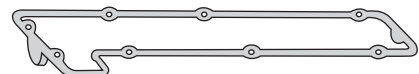

360510

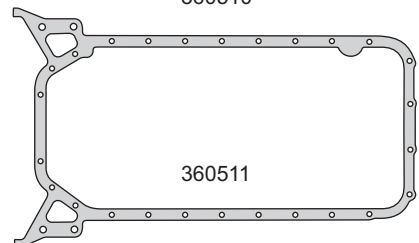

360511



360515



360517



351119

351129

351119-1

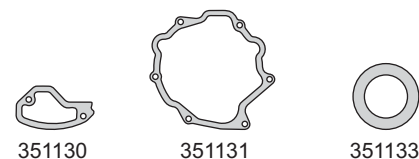

351130

351131

351133



G 17 x 4

A 12 x 15 x 1.5 A

G 8 x 2



A 22 x 27 x 1.5 A

A 27 x 32 x 2 A

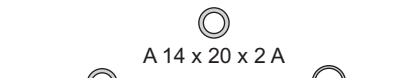

A 14 x 20 x 2 A

A 14.5 x 20 x 1.5 C

A 18.5 x 22 x 1.5 A



G 38 x 3

A 25 x 30 x 2 A

G 35 x 2

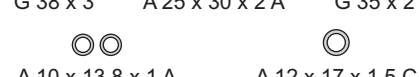

A 10 x 13.8 x 1 A

A 12 x 17 x 1.5 C



G 75 x 3

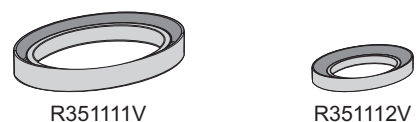

R351111V

R351112V



R360510V

MERCEDES BENZ

MERCEDES BENZ



Motor/Engine	Cm³	HP	Ø
MB271.946	1796	143	82
MB271.921	1796	122	82
MB271.940/941	1796	163	82
MB271.948 (DOHC) 16V	1796	192	82

Mercedes Benz: C180, C160, C200, CLK200 2002/... - E200 2003/... C230, SLK200 2004/...



Nº OE	Descripción/Description	Mat.	Ref.
	Jgo. de juntas para motor		370195 MLS
	Junta tapa cilindros Ø 83 ± 0.90	MLS 1	370108
	Conj. junta tapa válvulas (5)	GS 1	370110
	Múltiple escape	AC 1	370115
	Jgo. múltiple admisión (4)	GS 1	370117
	Jgo. retén válvulas (16)	V 1	R370110V

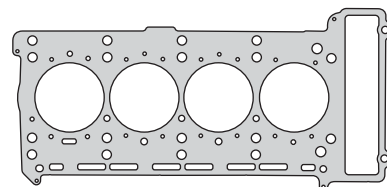

370108

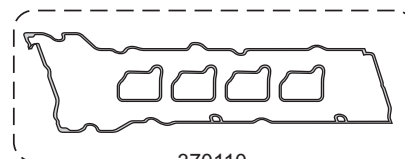

370110



370115

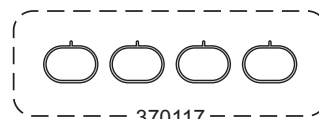

370117

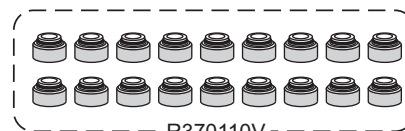

R370110V



MOTORES NAFTA - DIESEL

310407 	Código	Ø	Δ	Kit Bulón	Modelo
	310407	110.0	1.45	B310400 (HAS17038)	F100 1993/95 - F1000 1994/96 - F4000 1992/93 - F2000 1980/... FB4000 1985/... - Escavadora FB80
330507 - 330508 	Código	Ø	Δ	Kit Bulón	Modelo
	330507 330507-1.70 330508	96.0 96.0 96.0	1.40 1.70 1.40	B330500 (HAS17038)	Agrale TD - Micro/Buses - Chevrolet SD TD - Blazer TD 2000/... Blazer, S10 2000/..., LT TDI Electronico 2002/06 - Frontier Xterra 2007/...
330607 	Código	Ø	Δ	Kit Bulón	Modelo
	330607 330607-1.70	96.0 96.0	1.40 1.70	B330600 (HAS17038)	F100 GMC Turbo 1999/... - GM Silverado 3500HD 1997/... Grand Blazer 1998/...
400005 - 400007 - 400008 	Código	Ø	Δ	Kit Bulón	Modelo
	400005 400007 400008	92.5 92.5 92.5	1.40 1.40 1.15	B330600 (HAS19038)	F600 - D100 - D200 1987/... - F100 - Falcon 1970/...
410605 - 410607 	Código	Ø	Δ	Kit Bulón	Modelo
	410605 410607	104.0 104.0	1.70 1.70		GM D10/20/40 Aspirado Turbo - MF220 - F290 - Tractor MF85X Vehicular GM D20
410807 - 410808 	Código	Ø	Δ	Kit Bulón	Modelo
	410807 410808	93.0 93.0	1.40 1.25		Pick Up - Camiones Livianos
420607 	Código	Ø	Δ	Kit Bulón	Modelo
	420607	86.0	1.50		Rover - Maestro D/TD - Perkins - Marino 4.20 D/TD Leyland Sherpa 185/200/215/220/230/240/255 1986/94 Daf Ka 200/VS 200 1986/...
430007 - 430008 	Código	Ø	Δ	Kit Bulón	Modelo
	430007-1M 430007-2M 430007-3M 430007-4M 430008-1M 430008-2M 430008-3M	92.0 92.0 92.0 92.0 92.0 92.0 92.0	1.37 1.48 1.59 1.70 1.30 1.40 1.50	B430000 B430000-1 (HAS19038)	Ranger TDI - Blazer TDI - S10TDI 1995/... - Sprinter TDI 1997/... Range Rover TDI - Discovery TDI - Defender TDI 1990/94 - 1994/98
430607 - 430608 	Código	Ø	Δ	Kit Bulón	Modelo
	430607-1M 430607-2M 430607-3M 430607-4M 430608-1M 430608-2M 430608-3M	94.0 94.0 94.0 94.0 94.0 94.0 94.0	1.37 1.48 1.59 1.70 1.30 1.40 1.50	B430600 (HAS19038)	Ranger TD BR 2000-2002/...
430807 - 430808 	Código	Ø	Δ	Kit Bulón	Modelo
	430807/8-1M 430807/8-2M 430807/8-3M 430807/8-4M	98.0 98.0 98.0 98.0	1.30 1.40 1.50 1.60	B430800 (HAT60055) (HAT60100)	Ranger 3.0l - 4 x 4 - Full BR Intercooler

**INTERNATIONAL
MAXION-ROVER**



Motor/Engine	Cm³	HP	Ø
200-300 TDI	2495 2507	95/112 95	90.5 90.7

Ford: Ranger TDI 1995/...
Chevrolet: Blazer TDI - S10TDI 1995/...
Mercedes Benz: Sprinter TDI 1997/...
Rover: Range Rover - Discovery
 Defender TDI 1990/...



DIESEL

Nº OE	Descripción/Description	Mat.	1	2	Ref.
	Jgo. de juntas para motor				430001-R
	Jgo. de juntas superior		●		430095-1M
	Jgo. de juntas superior				430095-2M
	Jgo. de juntas superior				430095-3M
	Jgo. de juntas superior (MLS)				430095-1M MLS
	Jgo. de juntas superior (MLS)				430095-2M MLS
	Jgo. de juntas superior (MLS)				430095-3M MLS
ERR 5261	Junta tapa cilindros Ø 92 ≥ 1.37	NFT	1		430007-1M
ERR 5262	Junta tapa cilindros Ø 92 ≥ 1.48	NFT			430007-2M
ERR 5263	Junta tapa cilindros Ø 92 ≥ 1.59	NFT			430007-3M
	Junta tapa cilindros Ø 92 ≥ 1.70	NFT			430007-4M
ERR 5261	Junta tapa cilindros Ø 92 ≥ 1.30	MLS			430008-1M
ERR 5262	Junta tapa cilindros Ø 92 ≥ 1.40	MLS			430008-2M
ERR 5263	Junta tapa cilindros Ø 92 ≥ 1.50	MLS			430008-3M
	Jgo. tornillos tapa cilindros (HAS19038)				B430000
	Jgo. tornillos tapa cilindros (HAS19038)				B430000-1
ERR 2409	Conj. junta tapa válvulas (4)	N	1	1	430010
	Junta para cárter	NB		1	430011
ERR 4120	Tapa distribución	CB		1	430012
ERR 4860	Placa distribución	NB		1	430013
	Placa distribución	NB		1	430613
ERR 3284	Bomba de agua	NB		1	430014
ERR 3785	Múltiple admisión y escape	NFT	1	1	430015
	Placa bomba de agua	NB		1	430019
ERR 2028	Bomba combustible	NB		1	430028
	Arandela tapa válvulas	AC/GS	3	3	430030
	Junta base filtro	NB		1	430630
	Porta retén trasero	NB		1	430034
ERR 3283	Filtro aceite	NB		1	430037
	Arandela pico inyector	CU	4	3	330337
ERR 2023	Frente bomba inyectora	CB		1	430038
ERR 1561	Inspección frente distribución	CB		1	430039
ERR 2027	Bomba vacío	NB	1	1	430040
ERR 2027/1	Bomba vacío	NB	1	1	430041
ERR 1653	Caño aceite	NB		2	430042
	Arandela A 9 x 18 x 0.8	CB		3	430043
ERR 3490	Termostato carcaza	NB	1	1	430044
	Entre múltiple turbo	AC	1	1	500546
	Jgo. empaquetadura bancada cigüeñal (2)	GS		1	430058
ERR 2344	Arandela A 9.4 x 18 x 1F	F		1	
	Arandela A 12 x 17 x 1.5 C	CU		6	
	Arandela A 14 x 20 x 1.5 A	AL	4	4	
	Arandela A 19 x 27 x 1.5 A	AL		1	
	Arandela A 6 x 10 x 1 C	CU		8	
	O´ring G 23 x 3	GS	2	2	
ERR4710	O´ring G 37.47 x 3	GS		1	
	O´ring G 67 x 74 x 3	GS		1	
	Kit de retenes completo				R430000
	Jgo. retén válvulas (8)	V		1	R430010V
ERR4179	Porta retén bancada	VF			PR430011VF
ERR4575	Retén distribución 57 x 71 x 9	V		1	R430012V
ERR3956	Retén árbol de levas 46.7 x 62 x 9	V		1	R430013V
ERR4576	Retén guardapolvo correa distr. 57.5 x 74 x 8	N			R430015N

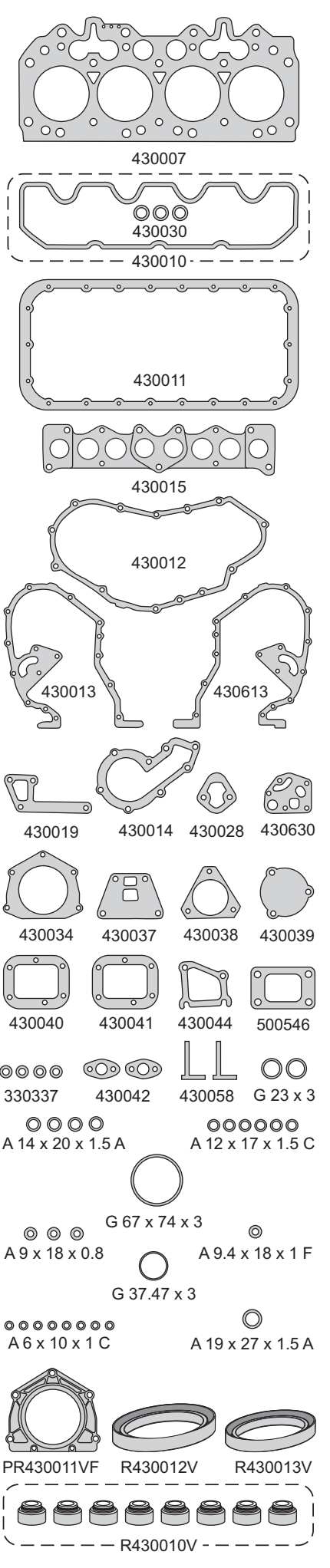

MAXION/PERKINS

**INTERNATIONAL
MAXION-ROVER**



Motor/Engine		Cm³	HP	Ø
Power Stroke		2758	135	93

Ford: Ranger TD BR 2000-2002/....

DIESEL



Nº OE	Descripción/Description	Mat.		Ref.
	Jgo. de juntas para motor			430001-R
	Jgo. de juntas superior (MLS)		●	430695-1M MLS
	Jgo. de juntas superior (MLS)			430695-2M MLS
	Jgo. de juntas superior (MLS)			430695-3M MLS
70490296	Junta tapa cilindros Ø 94 \times 1.37	NFT		430607-1M
70490297	Junta tapa cilindros Ø 94 \times 1.48	NFT		430607-2M
70490298	Junta tapa cilindros Ø 94 \times 1.59	NFT		430607-3M
70490299	Junta tapa cilindros Ø 94 \times 1.70	NFT		430607-4M
70490296	Junta tapa cilindros Ø 94 \times 1.30	MLS	1	430608-1M
70490297	Junta tapa cilindros Ø 94 \times 1.40	MLS		430608-2M
70490298	Junta tapa cilindros Ø 94 \times 1.50	MLS		430608-3M
	Jgo. tornillos tapa cilindros (HAS19038)			B430600
ERR 2409	Conj. junta tapa válvulas (4)	N	1	430010
	Junta para cárter	NB	1	430011
ERR 4120	Tapa distribución	CB	1	430012
ERR 4860	Placa distribución	NB	1	430013
	Placa distribución	NB	1	430613
ERR 3284	Bomba de agua	NB	1	430014
ERR 3785	Múltiple admisión y escape	NFT	1	430015
	Placa bomba de agua	NB	1	430019
ERR 2028	Bomba combustible	NB	1	430028
	Arandela tapa válvulas	AC/GS	3	430030
	Junta base filtro	NB	1	430630
	Porta retén trasero	NB	1	430034
ERR 3283	Filtro aceite	NB	1	430037
	Arandela pico inyector	CU	4	330337
ERR 2023	Frente bomba inyectora	CB	1	430038
ERR 1561	Inspección frente distribución	CB	1	430039
ERR 2027	Bomba vacío	NB	1	430040
ERR 2027/1	Bomba vacío	NB	1	430041
ERR 1653	Caño aceite	NB	2	430042
	Arandela A 9 x 18 x 0.8	CB	3	430043
ERR 3490	Termostato carcasa	NB	1	430044
	Salida escape turbo	AC	1	500546
	Jgo. empaquetadura bancada cigüeñal (2)	GS	1	430058
ERR 2344	Arandela A 9.4 x 18 x 1F	F	1	
	Arandela A 12 x 17 x 1.5 C	CU	6	
	Arandela A 14 x 20 x 1.5 A	AL	4	
	Arandela A 19 x 27 x 1.5 A	AL	1	
	Arandela A 6 x 10 x 1 C	CU	8	
	O´ring G 23 x 3	GS	2	
	O´ring G 37.47 x 3	GS	1	
	O´ring G 67 x 74 x 3	GS	1	
	Kit de retenes completo			R430000
	Jgo. retén válvulas (8)	V	1	R430010V
ERR4179	Porta retén bancada	VF		PR430011VF
ERR4575	Retén distribución 57 x 71 x 9	V	1	R430012V
ERR3956	Retén árbol de levas 46.7 x 62 x 9	V	1	R430013V
ERR4576	Ret. guardapolvo correa distr. 57.5 x 74 x 8	N		R430015N

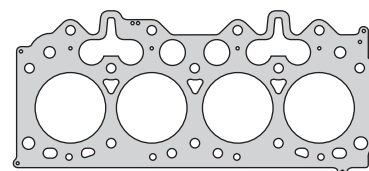

430607

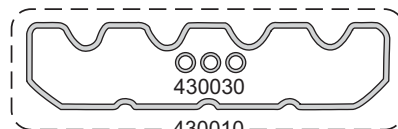

430030

430010

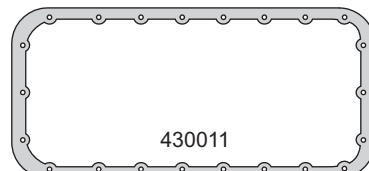

430011



430015

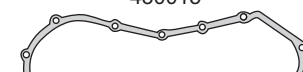

430012

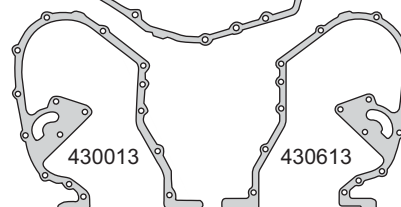

430013

430613



430019

430014

430028

430630

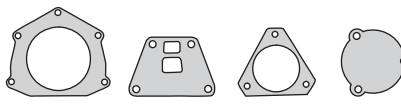

430034

430037

430038

430039

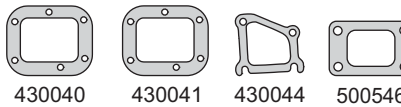

430040

430041

430044

500546

330337

430042

430058



A 14 x 20 x 1.5 A

A 12 x 17 x 1.5 C

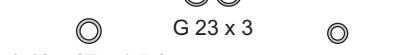

G 23 x 3

A 19 x 27 x 1.5 A

A 9.4 x 18 x 1 F

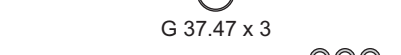

A 6 x 10 x 1 C

A 9 x 18 x 0.8



PR430011VF

R430012V

R430013V



R430010V

MAXION/WWW/PERKINS

**INTERNATIONAL
MAXION**



Motor/Engine	Cm³	HP	Ø
NGD 3.0E (SOHC) 16V	2798	163	96
DIESEL			

Ford: Ranger 3.0I - 4 x 4
Full BR Intercooler



Nº OE	Descripción/Description	Mat.	1	2	Ref.
7073000/418	Jgo. de juntas para motor				430801-R
	Jgo. de juntas superior (MLS)		●		430895-1M MLS
	Jgo. de juntas superior (MLS)				430895-2M MLS
	Jgo. de juntas superior (MLS)				430895-3M MLS
	Jgo. de juntas superior (MLS)				430895-4M MLS
	Junta tapa cilindros Ø 98 ≥ 1.30	NFT			430807-1M
	Junta tapa cilindros Ø 98 ≥ 1.40	NFT			430807-2M
	Junta tapa cilindros Ø 98 ≥ 1.50	NFT			430807-3M
	Junta tapa cilindros Ø 98 ≥ 1.60	NFT			430807-4M
70490793	Junta tapa cilindros Ø 98 ≥ 1.30	MLS	1		430808-1M
70490792	Junta tapa cilindros Ø 98 ≥ 1.40	MLS			430808-2M
70490791	Junta tapa cilindros Ø 98 ≥ 1.50	MLS			430808-3M
70490815	Junta tapa cilindros Ø 98 ≥ 1.60	MLS			430808-4M
70740783	Jgo. de tornillos JTC (HAT60055/HAT60100)				B430800
70490701	Jgo. junta tapa válvulas (5)	GS	1	1	430810
70490859	Jgo. junta tapa válvulas (5)	GS		1	430910
	Junta para cárter	NB		1	430011
70490824	Tapa distribución	NB		1	430812
70490823	Placa distribución a block	S		1	430813
70490785	Jgo. múltiple escape (4)	AC	1	1	430815
70490786	Jgo. múltiple admisión (4)	SLS	1	1	430817
70490690	Junta enfriado en aceite	NH			430827
70490700	Adaptador inyectores	GS	4	4	430831
70490709	Guarnición tubo succión aceite	GS		1	430832
70490704	Guarnición conexión entrada agua	GS	1	1	430833
70490692	Junta brida levantamiento delantero	NB			430834
70730061	Anillo con injerto metálico A 27 x 18 x 6.8	AC/GS			430836
	Junta	NB		1	430837
70490708	Entrada agua a block	GS		1	430838
70590021	Anillo cierre tapa inyectora distribución	GS		1	430839
	Guarnición cierre	GS		1	430840
	Guarnición cierre 68 x 62 x 2.5	GS			430841
70490814	Bomba inyectora	GS	1	1	430842
	Junta cañería agua	NB	1	1	430843
BF9T1036A	Arandela pico inyector A 7.5 x 15 x 2 C	CU	4	4	
70680019	O´ring camisa inyector G 21.95 x 1.78	GS	4	4	
70680020	O´ring G 10 x 2	GS		1	
70590015	O´ring G 42.9 x 3.53	GS		1	
	O´ring G 37.47 x 3	GS		1	
	Arandela A 6 x 17 x 1 F	F		1	
	Kit de retenes completo				R430800
70730060	Jgo. retén válvulas (16)	V	1		R430810V
70730043	Porta retén bancada	VF			PR430011VF
70730016	Retén distribución 60.32 x 79.36 x 9.5	V	1		R400012V

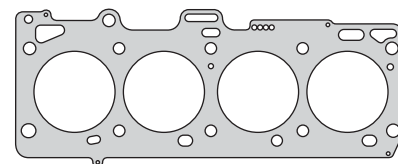

430808

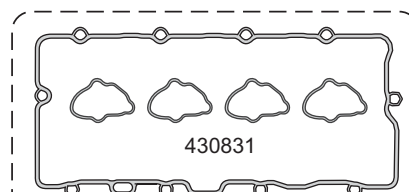

430831



430810

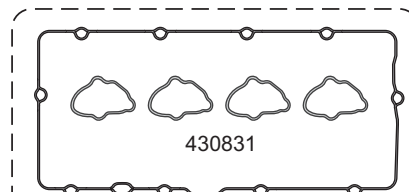

430831

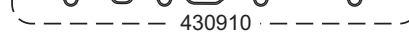

430910

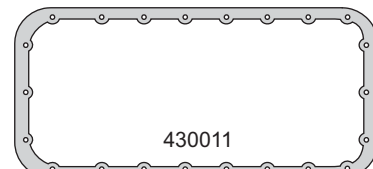

430011

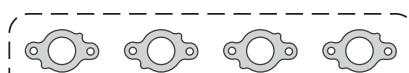

430815



430817

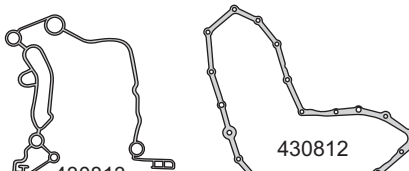

430813

430812



430832

430833

430834

430838

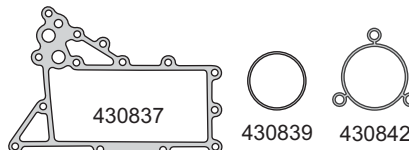

430837

430839

430842



430840

A 7.5 x 15 x 2 C

430843

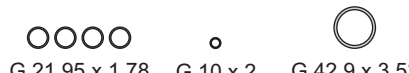

G 21.95 x 1.78

G 10 x 2

G 42.9 x 3.53

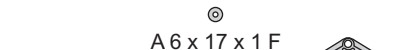

A 6 x 17 x 1 F



R400012V

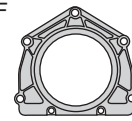

PR430011VF



R430810V

MAXION/MWM/PERKINS

MWM



Motor/Engine	Cm³	HP	Ø
D229-4	3922	96	102

Ford: F100 1993/95 - F1000 1994/96
F4000 1992/93 - F2000 1980/...
FB4000 1985/...

Fiat: Excavadora FB80



DIESEL

Nº OE	Descripción/Description	Mat.	Ref.
922900013005/87	Jgo. de juntas para motor		310400-R
	Jgo. de juntas superior		310495
622708541044	Jta. tapa cilindros Ø 110 \pm 1.45	NFT 4 4	310407
	Jgo. tornillos tapa cilindros (HAS17038)		B310400
920808530014	Junta tapa válvulas	N 4 4	310410
630508530164	Jgo. junta para cárter (4)	NB 1 1	310411
632508530184	Tapa distribución	NB 1 1	310412
632508530154	Distribución bomba aceite	NB 1 1	310413
922208530134	Tapa bomba de agua	NB 2 2	310414
632138530094	Jgo. múltiple escape y admisión (8)	NFT 1 1	310416
	Salida de escape 58 x 71 x 11	NFT 1 1	310418
620808530014	Placa bomba de agua	NB 1 1	310419
62290853052	Bomba alimentación	NB 1 1	220128
	Base bomba nafta	NB 1 1	550628
	Junta	NB 1 1	310430
	Junta	NB 1 1	310435
	Junta	NB 1 1	310434
922408530575	Base bomba inyección	NB 1 1	400435
930508530214	Base filtro aceite	NB 1 1	310437
632508530054	Tapa trasera bancada	NB 1 1	310438
604931060443	O'ring G 35 x 4	GS 1 1	310439
604931000202	O'ring G 20 x 2	GS 4 4	310440
604931000324	O'ring G 6 x 2	GS 1 1	310441
90411025515	Acople escape	NB 1 1	310541
632148530124	Bombin bomba inyectora	NB 1 1	310442
620508530124	Base bomba inyectora lineal	NB 1 1	310443
604931060204	O'ring G 42.2 x 3	GS 2 2	310444
922508510014	Curva escape	NFT 1 1	310445
630508530154	Acople con escape	NFT 1 1	310446
630508530164	Complemento cárter	NB 2 2	310447
632488510144	Fijación filtro aire	NB 1 1	310448
922508510044	Tapa inspección	NB 1 1	310449
	Caja velocidades F100/1000/clark 5V	VS 1 1	310450
604931040062	O'ring G 20 x 4	GS 1 1	310451
604931000344	O'ring G 45 x 3	GS 1 1	310452
	Palier F4000	CB 1 1	310456
	Diferencial DANA 46 F100-45/97- 96/98	NH 1 1	310459
	Tubo ventilación	AC 1 1	350462
	Colector a escape a turbo	NB 1 1	350662
	Junta caract. turabo MWM D229	AC 1 1	310463
6049313041124	Junta suplemento camisa cilindros G110 x 4	V 8 8	310470
904920101014	Arandela A 8 x 11 x 1 A	AL 1 1	
904920100814	Arandela A 8 x 12 x 1 A	AL 1 1	
904921101014	Arandela A 10 x 14 x 1.5 A	AL 4 4	
904920101418	Arandela A 14 x 18 x 1.5 A	AL 16 16	
604921100811	Arandela A 8 x 14 x 1 A	AL 3 3	
904921101018	Arandela A 10 x 16 x 1 A	AL 1 1	
	Arandela A 20 x 26 x 1 C	CU 1 1	
604920600211	Arandela tapón cárter A 22 x 27 x 1 A	AL 1 1	
606901281017	Arandela A 10 x 20 x 2 C	CU 4 4	
	Arandela A 40 x 60 x 1.5	NB 1 1	
	Arandela A 12 x 18 x 1.5 A	AL 2 2	
	Arandela A 14 x 20 x 1.5 A	AL 2 2	

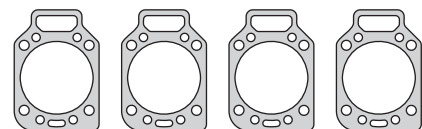

310407



310410

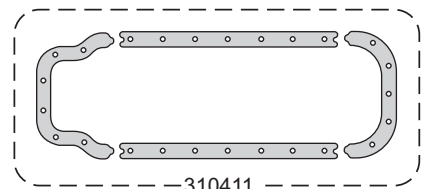

310411

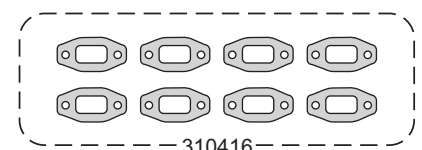

310416

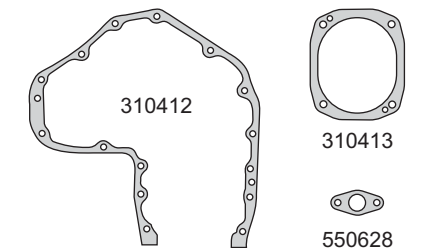

310412

310413

550628

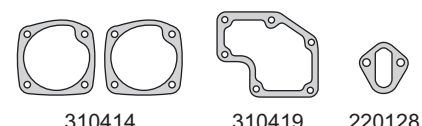

310414

310419

220128

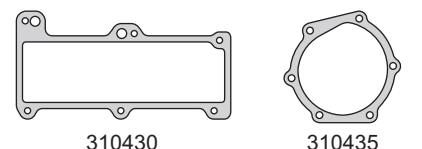

310430

310435



310437

310434

400435

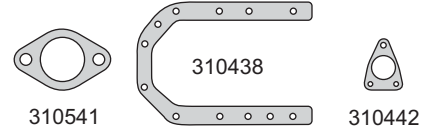

310541

310438

310442

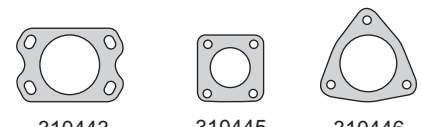

310443

310445

310446

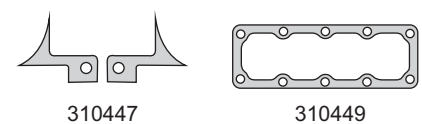

310447

310449

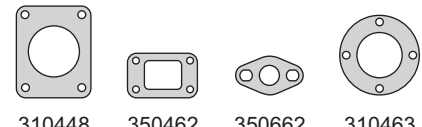

310448

350462

350662

310463

MAXION/MWM/PERKINS

MWM



Motor/Engine	Cm³	HP	Ø
D229-4	3922	96	102

Ford: F100 1993/95 - F1000 1994/96
 F4000 1992/93 - F2000 1980/...
 FB4000 1985/...
Fiat: Excavadora FB80



DIESEL

Nº OE	Descripción/Description	Mat.	4	1	Ref.
	Arandela A 16 x 20 x 1.5 C	CU			
	O'ring G 30.8 x 3.7	GS		1	
	O'ring G 46 x 3	GS			
	Kit de retenes completo				R310400
	Jgo. retén válvulas (8)	V		1	R310410V
	Retén bancada 110 x 130 x 13	P		1	R310411P
	Retén distribución 78 x 100 x 13	V		1	R310412V

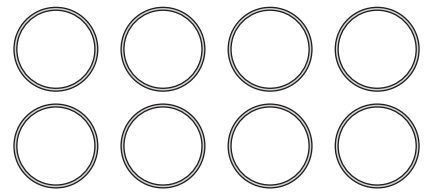

310470

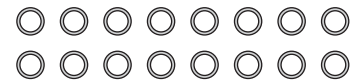
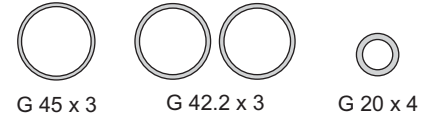

A 14 x 18 x 1.5 A



A 16 x 20 x 1.5 C



A 8 x 11 x 1 A



G 40 x 60 x 1.5



G 30.8 x 3.7



G 20 x 2



A 8 x 14 x 1 A



A 10 x 14 x 1.5 A



A 10 x 20 x 2 C



A 10 x 16 x 1 A



A 8 x 12 x 1 A



A 16 x 20 x 1.5 C



A 14 x 20 x 1.5 A



A 20 x 26 x 1 C



G 6 x 2



A 12 x 18 x 1.5 A



A 22 x 27 x 1 A



R310412V



R310411P

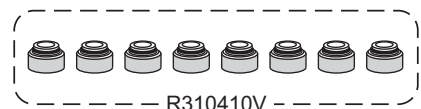

R310410V

MAXION/MWM/PERKINS

MWM



Motor/Engine	Cm³	HP	Ø
MWM 4.07 CA	2796	131	93
Sprint 4.07 CA	2796	125/132	93
AGK-ATA	2796	125/131	93
BCQ	2796	158	93

Chevrolet: SD TD - Blazer TD 2000/...
Nissan: Frontier - X Terra 2003/6
MWM: Agrale TD (Micro/Omnibus) 2000/...
Volkswagen: LTDI 1997/...
 Electrónico 2003/06



DIESEL

Nº OE	Descripción/Description	Mat.	Ref.
	Jgo. de juntas para motor		330500-R
11044-880A	Junta tapa cilindros Ø 96 ± 1.40	NFT	1 330507
	Junta tapa cilindros Ø 96 ± 1.70	NFT	330507-1.7
	Junta tapa cilindros Ø 96 ± 1.40	MLS	330508
	Jgo. tornillos tapa cilindros (HAS17038)		B330500
	Conj. junta tapa válvulas (6)	N	1 330510
	Junta para cárter	NB	1 330511
	Tapa distribución	NB	1 330512
0853-0/184	Junta bomba aceite frente motor	NB	1 330513
	Múltiple escape	NFT	4 330515
	Múltiple admisión	NB	1 330517
	Termostato	NB	1 330519
	Guarnición goma	GS	1 870232
	Radiador aceite	NFT	1 330536
	Tapa radiador aceite	NB	1 330537
	Guarnición goma inyectores	GS	4 330539
	Guarnición goma	GS	5 330540
	Junta entrada aceite turbo	NB	1 331141
	Junta salida aceite turbo	NB	1 331142
	Bomba inyectora	NB	1 400146
	O'ring G 105.46 x 3.53	GS	1
	O'ring G 82.22 x 2.62	GS	1
	O'ring G 76 x 2.5	GS	1
	O'ring G 66.27 x 3.53	GS	1
	O'ring G 44.12 x 2.62	GS	2
	O'ring G 45 x 2.5	GS	1
	O'ring G 40.87 x 3.53	GS	1
	O'ring G 32.92 x 3.53	GS	1
	O'ring G 20 x 2	GS	1
	Arandelas A 21 x 30.5 x 2 A	AL	2
	Arandelas A 20 x 24.5 x 1.5 A	AL	2
	Arandelas A 18 x 22 x 1.5 A	AL	2
	Arandelas A 16 x 20 x 1 A	AL	5
	Arandelas A 14 x 18 x 1.5 A	AL	5
	Arandelas A 14 x 18 x 1.5 C	CU	2
	Arandelas A 12 x 18 x 1.5 A	AL	5
	Arandelas A 7 x 15 x 2 C	CU	4
	Arandelas A 10 x 14 x 1 A	AL	5
	Arandelas A 8 x 12 x 1 C	CU	29
	Arandelas A 6 x 10 x 1 C	CU	13
	Kit de retenes completo		R330500
	Jgo. retén válvulas (12)	V	1 R330510V
	Retén bancada 91 x 111 x 10	V	1 R330511V
	Retén distribución 64 x 80 x 8	V	1 R250811V

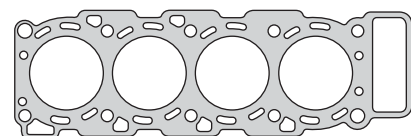

330507

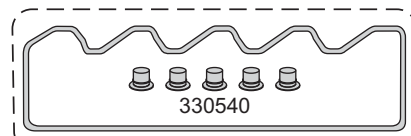

330540

330510

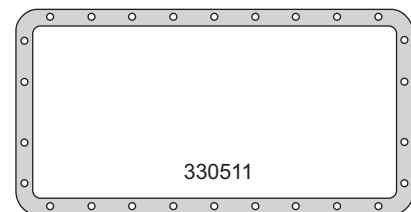

330511



330517



330515

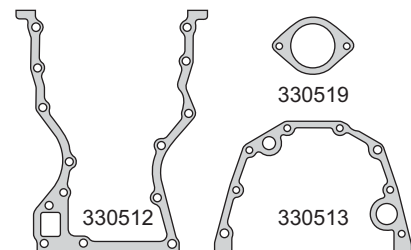

330512

330513

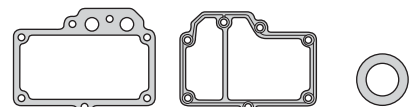

330537

330536

870232

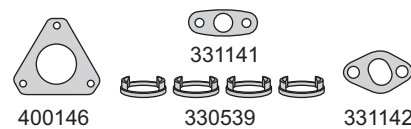

400146

331141

330539

331142

A 7 x 15 x 2 C

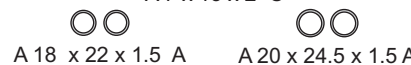

A 18 x 22 x 1.5 A

A 20 x 24.5 x 1.5 A

A 12 x 18 x 1.5 A



A 14 x 18 x 1.5 A

A 16 x 20 x 1 A

A 8 x 12 x 1 C



A 14 x 18 x 1.5 C

A 10 x 14 x 1 A

A 21 x 30.5 x 2 A

A 6 x 10 x 1 C



R250811V

R330511V

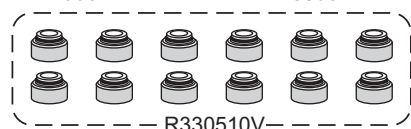

R330510V

MAXION/MWM/PERKINS

MWM



Motor/Engine	Cm³	HP	Ø
Sprint 6.07 TD Turbo Intercooler	4200	167/198	93

Ford: F100 GMC Turbo 1999/...
Chevrolet: GM Silverado 3500HD 1997/...
 GM Gran Blazer 1998/...



DIESEL

Nº OE	Descripción/Description	Mat.	Ref.
	Jgo. de juntas para motor		330600-R
	Jgo. de juntas superior	●	330695
	Junta tapa cilindros Ø 96 ± 1.40	NFT	330607
	Junta tapa cilindros Ø 96 ± 1.70	NFT	330607-1.7
	Jgo. tornillos tapa cilindros (HAS17038)		B330600
	Jgo. junta tapa válvulas (8)	N	330610
	Junta para cárter	NB	330611
	Tapa distribución	NB	330512
0853-0/184	Junta aceite bomba frente motor	NH	330513
	Múltiple escape	NFT	330515
	Múltiple admisión y escape	CG	330617
	Base termostato	NB	330619
	Base termostato	NB	330629
	Retorno	NB	330630
	Guarnición goma	GS	870232
	Radiador aceite	NFT	330536
	Radiador aceite	NB	330537
	Guarnición termostato	GS	330638
	Guarnición goma inyectores	GS	330539
	Guarnición goma	GS	330540
	Junta entrada aceite turbo	NB	331141
	Junta salida aceite turbo	NB	331142
	Bomba inyectora	NB	400146
	O´ring G 105.46 x 3.53	GS	
	O´ring G 102.99 x 3.2	GS	
	O´ring G 82.14 x 3.53	GS	
	O´ring G 79.5 x 3	GS	
	O´ring G 66.27 x 3.53	GS	
	O´ring G 44.12 x 2.62	GS	
	O´ring G 40 x 5	GS	
	O´ring G 40.87 x 3.53	GS	
	O´ring G 31.42 x 2.62	GS	
	O´ring G 31.55 x 3.72	GS	
	O´ring G 28.17 x 3.53	GS	
	O´ring G 21.89 x 2.62	GS	
	O´ring G 13.94 x 2.62	GS	
	Arandela A 21 x 30.5 x 2 A	AL	
	Arandela A 20 x 24 x 1.5 A	AL	
	Arandela A 18 x 22 x 1.5 A	AL	
	Arandela A 16 x 20 x 1 A	AL	
	Arandela A 14 x 18 x 1.5 A	AL	
	Arandela A 12 x 18 x 1.5 A	AL	
	Arandela A 7 x 15 x 2 C	CU	
	Arandela A 10 x 14 x 1 A	AL	
	Arandela A 8 x 14 x 1 A	AL	
	Arandela A 8 x 12 x 1 A	AL	
	Arandela A 8 x 12 x 1 C	CU	
	Arandela A 6 x 10 x 1 C	CU	
	Kit de retenes completo		R330600
	Jgo. retén válvulas (18)	V	R330610V
	Retén distribución 64 x 80 x 8	V	R250811V
	Retén bancada 91 x 111 x 10	V	R330511V

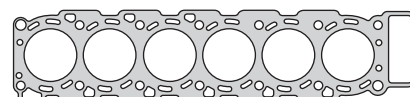

330607

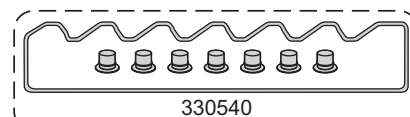

330540
330610

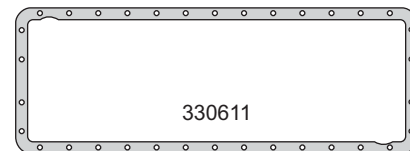

330611



330617



330515

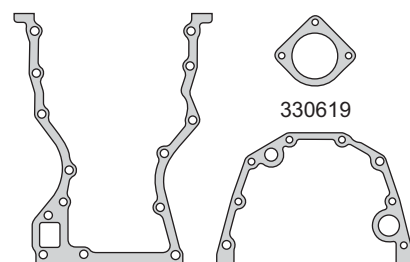

330619



330512

330513

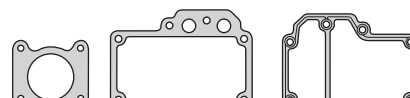

330629 330537 330536



330630 330539

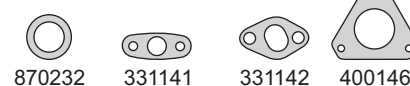

870232 331141 331142 400146



A 7 x 15 x 2 C



A 18 x 22 x 1.5 A A 20 x 24 x 1.5 A

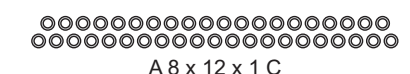

A 8 x 12 x 1 C



A 12 x 18 x 1.5 A A 16 x 20 x 1 A



A 14 x 18 x 1.5 A



A 10 x 14 x 1 A A 8 x 12 x 1 A



A 6 x 10 x 1 C



A 8 x 14 x 1 A A 21 x 30.5 x 2 A



R250811V

R330511V

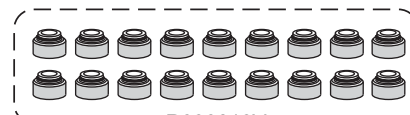

R330610V

MAXION/MWM/PERKINS

MWM



Motor/Engine	Cm³	HP	Ø
Sprint 4.07 TCA	2796	132	93
VW28TI	2796	132	93
BCQ	2796	158	93

Chevrolet: Blazer - S10 2000/...
Nissan: Frontier - X Terra Electrónico 2007/...
Volkswagen: LT TDI Electrónico 2002/06
 Common Rail

DIESEL



Nº OE	Descripción/Description	Mat.	Ref.
101012DB-OA	Jgo. de juntas para motor		331100-R MLS
	Jgo. de juntas superior (MLS)	●	331195 MLS
110442	Junta tapa cilindros Ø 96 \pm 1.40 N.R.	MLS 1	330508
1103565313	Jgo. tornillos tapa cilindros (HAS17038)		B330500
132706530	Junta tapa válvulas	GS 1	330510
111405300	Junta para cárter	NB 1	331111
94078853018	Frente motor	NB 1	330512
44070853115	Junta bomba aceite frente motor	NH 1	330513
35308401	Jgo. múltiple escape (4)	GFT 1	331115
2130465310	Múltiple admisión	NB 1	330517
206915700	Salida de escape	AC	331118
206925300	Junta acople caño escape	AC	331136
	Junta radiador aceite	NB 1	330537
	Guarnición llenado aceite	GS 1	870232
	Guarnición goma inyectores	GS 4	330539
21014-6N210	Guarnición goma	GS 5	330540
1519665300	Junta entrada aceite turbo	NB 1	331141
1518665300	Junta salida aceite turbo	NB 1	331142
	O'ring G 105.46 x 3.53	GS 1	
	O'ring G 94.84 x 3.53	GS 1	
	O'ring G 88.49 x 3.53	GS 1	
	O'ring G 85.32 x 3.53	GS 1	
	O'ring G 82.22 x 2.62	GS 1	
	O'ring G 72.62 x 3.53	GS 2	
	O'ring G 66.27 x 3.53	GS 1	
	O'ring G 62.87 x 5.33	GS 1	
	O'ring árbol de levas G 60.6 x 3.53	GS 1	
	O'ring G 59.92 x 3.53	GS 1	
	O'ring termostato G 54.5 x 3.53	GS 1	
	O'ring G 45 x 2.5	GS 1	
	O'ring G 44.12 x 2.62	GS 2	
	O'ring G 40.87 x 3.53	GS 1	
	O'ring G 32.92 x 3.53	GS 1	
	O'ring G 28.17 x 3.53	GS 1	
	O'ring G 13.87 x 3.53	GS 4	
	Arandelas A 21 x 30 x 2 A	AL 1	
	Arandelas A 20 x 26 x 1 A	AL 3	
	Arandelas A 20 x 26 x 1.5 C	CU 5	
	Arandelas A 18 x 22 x 1.5 A	AL 2	
	Arandelas A 17 x 20 x 1.5 C	CU 3	
	Arandelas A 15 x 18 x 1 A	AL 4	
	Arandelas A 12 x 18 x 1.5 A	AL 2	
	Arandelas A 7.5 x 15 x 2 C	AL 4	
	Arandelas A 8.5 x 12 x 1 C	CU 4	
	Kit de retenes completo		R330500
	Jgo. retén válvulas (12)	V 1	R330510V
	Retén bancada 91 x 111 x 10	V 1	R330511V
	Retén distribución 64 x 80 x 8	V 1	R250811V

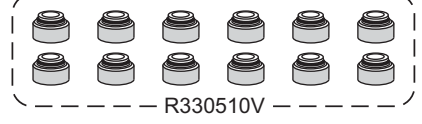
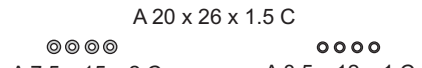
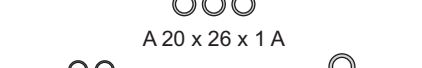
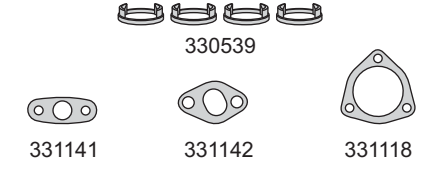
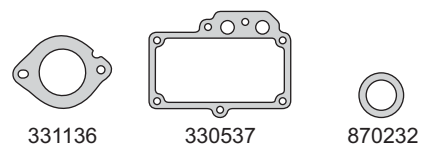
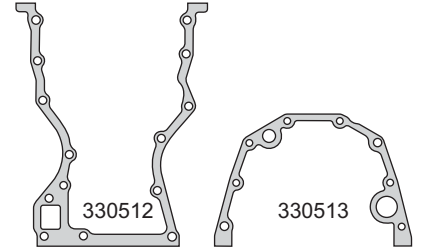
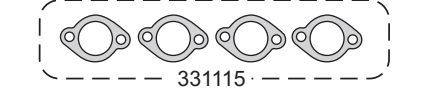
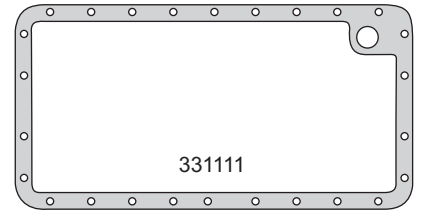
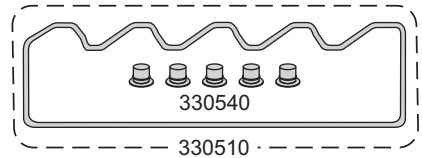
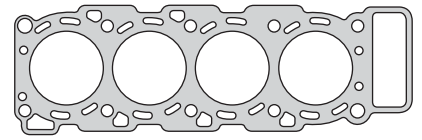

MAXION/MWM/PERKINS

PERKINS



Motor/Engine **4.203-P4-192Z**
 Cm³ **3336**
 HP **71**
 Ø **91.49**

Dodge: D100 - D200 1987/...
 Ford: F100 - Falcon 1970/...

DIESEL



Nº OE	Descripción/Description	Mat.	Ref.
105379	Jgo. de juntas para motor		400000-R
	Jgo. de juntas superior		400095
	Jgo. de juntas superior		400095/7
	Junta tapa cilindros Ø92.5 ± 1.40		400005
36812125	Junta tapa cilindros Ø92.5 ± 1.40 N.R.	NFT	400007
36812125	Junta tapa cilindros Ø92.5 ± 1.15 N.R.	CNC	400008
	Jgo. tornillos tapa cilindros (HAS19038)		B400000
0490704	Conjunto junta tapa válvulas (4)	CG	400010
003248	Jgo. junta para cárter (4)	NB	400011
006072	Tapa distribución	NB	400012
36814112	Block caja distribución	NB	400013
36866417	Bomba de agua placa trasera	NB	400014
006002	Jgo. múltiple escape (2)	FCH	400015
006061	Múltiple admisión	NFT	400017
0490032	Salida de escape	FCH	400018
	Arandela tapa válvulas	GS	400130
	Arandela base inyector A 14 x 20 x 1.5 C	CU	400033
33825409	Tapa frontal a tapa inspección	NB	400034
066081	Tapa trasera cigüeñal	NB	400035
0490485	Tapa trasera tapa cilindro	NB	400036
0066054	Tapa precámara combustible	CU	400037
006054	Precámara combustión	AL	410037
33826111	Porta retén bancada trasera	NB	400038
36866416	Caja distribución bomba vacío	NB	400039
0490867	Tapa trasera termoarranque	CG	400140
36853105	Caja distribución tapa toma fuerza	NB	400045
0490685	Comando bomba combustible	NB	400146
0490699	Tapa trasera árbol levas	NB	400047
0490692	Conexión entrada agua	NB	400048
36835411	Conexión salida agua	NB	400051
0490024	Salida agua a tapa	NB	400052
0490391	Cuerpo codo paso agua	NB	400153
006007	Filtro aceite a block	NB	400057
36883106	Jgo. juntas bancada cigüeñal (2)	SLA	400158
	Junta base depresor	NB	400059
36866428	Bomba vacío tapa brida	NB	400062
006074	Bomba alimentación combustible	NB	400165
36865543	Soporte bomba inyectora	NB	400066
	Kit arandelas (57)	VS	400075
	Arandela A 10 x 14 x 1 A	AL	15
	Arandela A 13 x 20 x 1 A	AL	10
	Arandela A 17.5 x 22 x 1 A	AL	10
	Arandela A 19 x 27 x 2 A	AL	1
	Arandela A 8 x 12.5 x 1 A	AL	15
	Arandela A 14.5 x 20.5 x 1.5 C	CU	6
	Kit de retenes completo 4.203 hasta 1987		R400000
	Kit de retenes completo 4.203 1988/...		R400000-1
	Jgo. retén válvulas (8)	P	R300310P
	Jgo. retén válvulas (8)	P	R400010P
	Retén bancada 133.35 x 158.75 x 11/13	P	R400211P
	Retén distribución 60.32 x 79.36 x 9.5	P	R400012P

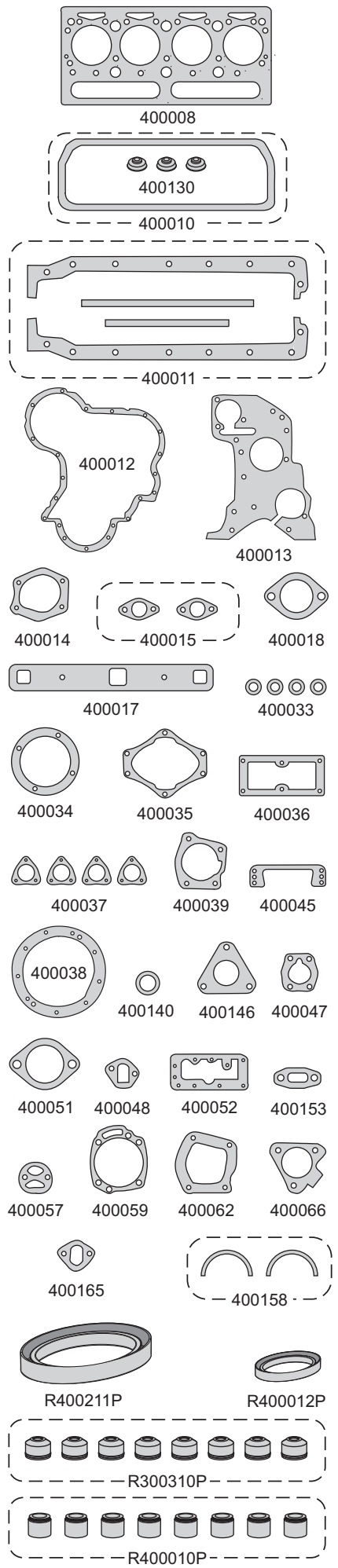

MAXION/WWW/PERKINS

PERKINS



Motor/Engine	Cm³	HP	Ø
Q20B4 Iny. Directa	3860	70	98.4

Chevrolet: Vehicular GM D20

DIESEL

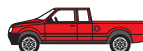

Nº OE	Descripción/Description	Mat.	Ref.
424801/423607	Jgo. de juntas para motor		401000-R
	Jgo. de juntas superior		401095
36812338	Jta. tapa cilindros Ø 104 \pm 1.70	NFT	410607
70490149	Junta tapa válvulas	CG	410610
70490178	Junta para cárter	CG	280311
36813138	Tapa distribución	NB	410612
36814127	Placa distribución	NB	410613
36866724	Tapa bomba de agua trasera	NB	410614
36862134	Jgo. múltiple escape (2)	FCH	410616
0490301	Salida de escape	FCH	400218
70490144	Bomba de agua a block	NB	410619
36866416	Adaptador bomba vacio	NB	410630
70490146	Block a bomba de agua	NB	410631
36867156	Bomba de agua a block	NB	410731
36853514	Cuerpo salida agua	NB	410632
36851409	Tapa trasera tapa cilindros	NB	410633
36862517	Filtro lubricación block y placa	NB	410634
36834143	Bomba inyectora	NB	400435
0490734	Carcasa termostato	NB	410635
36817157	Porta retén bancada trasera	NB	400236
36862133	Múltiple admisión central	NB	410636
36862151	Conexión superior salida de agua	NB	410637
36862131	Múltiple admisión trasera	NB	410638
36866462	Múltiple admisión frontal	NB	410639
7049145	Cuerpo delantero y trasero bomba de agua	NB	410640
36835425	Carcaza a conexión superior	CG	410641
32811113	Bastón placa interior a block	GS	400442
36851113	Bomba alimentación a block	NB	410642
36832122	Tubo succión bomba aceite	NB	410643
36825107	Cierre inspección distribución	NB	400244
0490355	Tubo succión a válvula alimentación	NB	410644
36822111	Colector escape	NFT	410645
0490773	Comando bomba inyectora	NB	400146
70490100	Acoplamiento bomba inyectora	NB	410546
	Anillo lubricación tapa cilindros G10.7 x 6.2 x 6	GS	400646
	Adaptador vacio	NB	410747
	Junta placa ventilación	NB	410649
	Junta base bomba de nafta	NB	410650
	Junta válvula alivio	NB	410651
	Junta válvula alivio	NB	410652
	Junta conexión	NB	410653
	Junta base bomba de nafta	NB	410654
	Bomba de vacio a brida	NB	400062
	Arandela A 10 x 20 x 2 C	CU	4
	Arandela A 10 x 14 x 1.5 A	AL	4
	Arandela A 14 x 20 x 1.5 A	AL	10
	Arandela A 20 x 26 x 1 A	AL	1
	Arandela A 8 x 10 x 1 A	AL	8
	O´ring G 21 x 35 x 13	GS	4
	Kit de retenes completo		R410600
	Jgo. retén válvulas (8)	P	1 R300310P
	Retén bancada 133.35 x 158.75 x 11/13	P	1 R400211P
	Retén distribución 60.32 x 79.36 x 9.5	P	1 R400012P

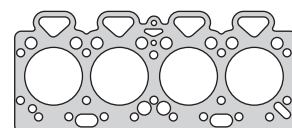

410607

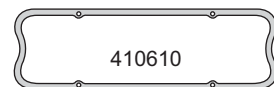

410610

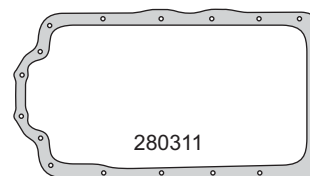

280311

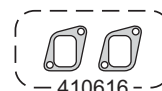

410616

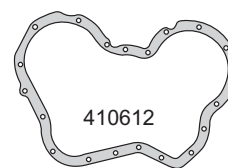

410612

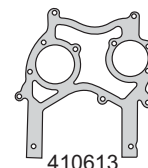

410613



410614



410619



400218



410630



410631

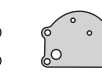

410731

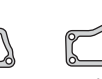

410632



410633



410634



400435



410635



400236



410636



410637



410638



410639



410640



410641



410642



400442



410643



410644



400244



400146



410546



410645



410747



400062



410649



410650



410651



410652



410653

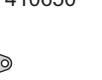

410654



R400211P



R400012P

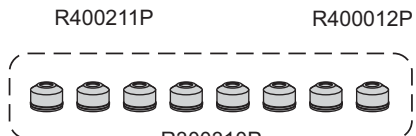

R300310P

MAXION/WWW/PERKINS

PERKINS



Motor/Engine	Cm³	HP	Ø
4.203 Potenciado	3336	71	91.44

Ford: F100

DIESEL



Nº OE	Descripción/Description	Mat.	Ref.
	Jgo. de juntas para motor		410000-R
36812125	Junta tapa cilindros Ø 92.5 ± 1.40	NFT	400007
	Jgo. tornillos tapa cilindros (HAS19038)		B400000
0490704	Conjunto tapa válvulas superior (4)	CG	400010
	Jgo. junta para cárter (4)	NB	410011
006072	Tapa distribución	NB	400012
36814112	Block caja distribución	NB	400013
36866417	Bomba de agua	NB	400014
006002	Jgo. múltiple escape (2)	FCH	400015
006061	Múltiple admisión	NFT	400017
0490032	Salida de escape	FCH	400018
36883106	Arandela tapa válvulas	GS	400130
	Arandela base inyector A 14 x 20 x 1.5 C	CU	400033
33825409	Tapa frontal a tapa inspección	NB	400034
0490485	Tapa trasera tapa cilindro	NB	400036
006054	Tapa precámara combustión	CU	400037
006054	Precámara combustión	AL	410037
33826111	Porta retén bancada trasera	NB	400038
36866416	Caja distribución a bomba vacío	NB	400039
0490867	Tapa trasera termoarranque	CG	400140
36853105	Caja distribución tapa toma fuerza	NB	400045
0490685	Comando bomba combustible	NB	400146
0490699	Tapa trasera árbol levas	NB	400047
0490692	Conexión entrada agua	NB	400048
36835411	Conexión salida agua	NB	400051
0490024	Salida agua a tapa	NB	400052
0490184	Termostato	NB	400053
0490391	Cuerpo codo paso agua	NB	400153
006007	Filtro aceite a block	NB	400057
36866428	Bomba vacío tapa brida	NB	400062
006074	Bomba alimentación combustible	NB	400165
36865543	Soporte bomba inyectora	NB	400066
003152	Tapa inspección cárter	NB	410167
	Kit arandelas (57)	VS	400075
	Arandelas A 10 x 14 x 1 A	AL	15
	Arandelas A 13 x 20 x 1 A	AL	10
	Arandelas A 14.5 x 20.5 x 1.5 C	CU	6
	Arandelas A 17.5 x 22 x 1 A	AL	10
	Arandelas A 19 x 27 x 2 A	AL	1
	Arandelas A 8 x 12.5 x 1 A	AL	15
	Kit de retenes completo		R400000-1
	Jgo. retén válvulas (8)	P	1 R400010P
	Jgo. retén válvulas (8)	P	1 R300310P
	Retén bancada 133.35 x 158.75 x 11/13	P	1 R400211P
	Retén distribución 60.32 x 79.36 x 9.5	P	1 R400012P

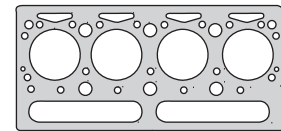

400007

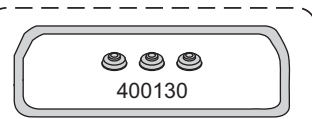

400130

400010

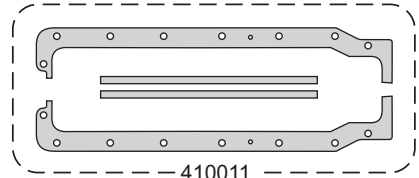

410011

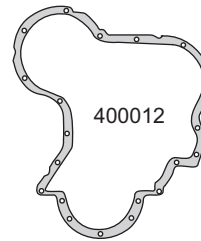

400012

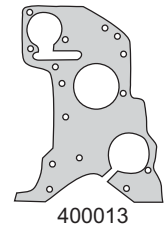

400013



400014

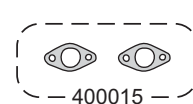

400015



400018



400017



400033



400034

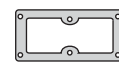

400036



400038

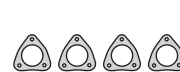

400037



400039



400140

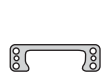

400045



400146



400048



400047



400051

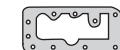

400052



400153



400057



400062



400165



400066



400167



R400211P



R400012P



R300310P



R400010P

MAXION/WWW/PERKINS

PERKINS



Motor/Engine	Cm³	HP	Ø
Q20B4 - 4.236	3860	70	98.4
4.248	4070	70	101

Chevrolet: GM D10/20/40 Aspirado Turbo
Massey Ferguson: MF220 - F290 - MF85X
Maxion-Perkins: GM D10 - F350 - VW6.80 Case 550



DIESEL

Nº OE	Descripción/Description	Mat.	Ref.
424801/423607	Jgo. de juntas para motor		410600-R
	Jgo. de juntas superior		410695
	Jta. tapa cilindros Ø 104 \pm 1.70	NFT	410605
36812338	Jta. tapa cilindros Ø 104 \pm 1.70	NFT	410607
70490149	Junta tapa válvulas	CG	410610
36815706	Junta para cárter	NB	410611
36813138	Tapa distribución	NB	410612
36814127	Placa distribución	NB	410613
36866724	Tapa bomba de agua trasera	NB	410614
36862134	Jgo. múltiple escape (2)	FCH	410616
0490301	Salida de escape	FCH	400218
70490144	Bomba de agua a block	NB	410619
36866416	Adaptador bomba de vacío	NB	410630
70490146	Block a bomba de agua	NB	410631
36853514	Cuerpo salida agua	NB	410632
0921173	Arandela pico inyector A 10 x 20 x 1.5 C	CU	410533
36851409	Tapa trasera tapa cilindros	NB	410633
36862517	Filtro lubricación block y placa	NB	410634
36834143	Bomba inyectora	NB	400435
0490734	Carcasa termostato	NB	410635
36817157	Porta retén bancada trasera	NB	400236
36862133	Múltiple admisión central	NB	410636
36862151	Conexión superior salida de agua	NB	410637
002794	Base filtro aceite	NB	400238
36862131	Múltiple admisión trasera	NB	410638
36865511	Distribución a bomba de vacío	NB	400039
36866462	Múltiple admisión frontal	NB	410639
7049145	Cuerpo delantero y trasero bomba de agua	NB	410640
36835425	Carcasa a conexión superior	CG	410641
32811113	Bastón placa interior a block	GS	400442
36851113	Bomba alimentación a block	NB	410642
36832122	Tubo succión bomba aceite	NB	410643
	Junta succión a lubricación aceite	NB	410743
36825107	Cierre inspección distribución	NB	400244
0490355	Tubo succión a válvula alimentación	NB	410644
	Junta boca lubricación	NB	410744
36822111	Colector escape	NFT	410645
0490773	Comando bomba inyectora	NB	400146
70490100	Acoplamiento bomba inyectora	NB	410546
	Adaptador vacío	NB	410747
	Bomba de vacío a brida	NB	400062
36817136	Porta retén bancada trasera	NB	400283
36866416	Anillo lubricación tapa cilindros G 7.2 x 11 x 6	GS	
	Arandela A 10 x 20 x 2 C	CU	
	Kit de retenes completo		R410600
	Jgo. retén válvulas (8)	P	R300310P
	Jgo. retén válvulas (8)	P	R400210P
	Retén bancada 133.35 x 158.75 x 11/13	P	R400211P
	Retén distribución 60.32 x 79.36 x 9.5	P	R400012P

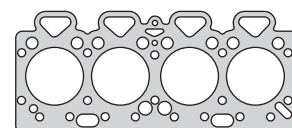

410607

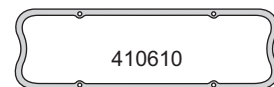

410610

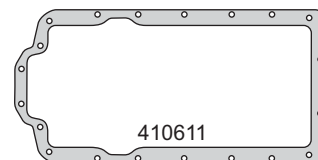

410611

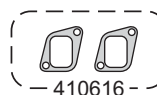

410616

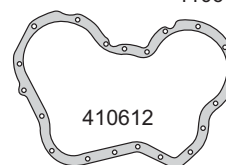

410612

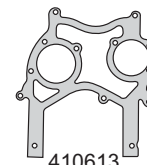

410613



410614

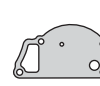

410619



400218



410630



410631



410632



410533



410533



410633



410634



400435



410635



410633



410634



400435



410635



400236



410636

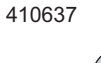

410637



400238



410638



400039

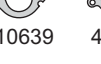

410639



410640



410641

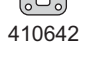

410642



400442



410643



410743

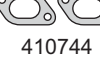

410744



410644



400244



400146



410546



410645



410645



410747



400062



400283



400283



R400211P



R400012P

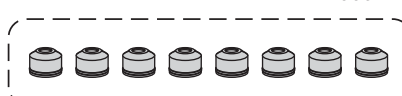

R300310P

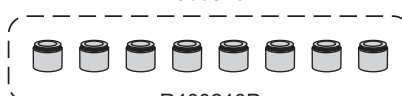

R400210P

MAXION/WWW/PERKINS

PERKINS



Motor/Engine	Cm³	HP	Ø
T 4.33 Turbo Iny. Directa	3330	91/95	91.46

Perkins: Pick Up - Camiones livianos



DIESEL

Nº OE	Descripción/Description	Mat.	Ref.
005967	Jgo. de juntas para motor	●	410800-R
006283	Junta tapa cilindros Ø 93 \pm 1.40	NFT	410807
	Junta tapa cilindros Ø 93 \pm 1.25	CNC	1 410808
0490704	Conj. junta tapa válvulas (4)	CG	1 400010
006076	Jgo. junta para cárter (4)	NB	1 410011
006072	Tapa distribución	NB	1 400012
36814112	Placa distribución	NB	1 400013
36866417	Tapa bomba de agua	NB	1 400014
006322	Jgo. múltiple escape (2)	NFT	1 410816
006061	Múltiple admisión	NFT	1 400017
0490184	Conexión salida agua	CB	1 300019
	Arandelas tapa válvula	GS	3 400130
36833148	Drenaje aceite turbo	NB	1 400432
33825409	Tapa frontal	NB	1 400034
3686454	Turbo a descarga caño aceite	NB	1 410834
36832131	Entrada aceite turbo	NB	1 410835
0490485	Tapa trasera	NB	1 400036
006319	Múltiple admisión a codo admisión	NB	1 410836
006320	Turbo a codo salida de escape	NFT	1 410837
338261111	Porta retén bancada	NB	1 400038
36866416	Caja distribución bomba vacío	NB	1 400039
36822111	Codo a salida de escape	NFT	1 410645
006323	Comando bomba combustible	NB	1 400246
0490699	Tapa trasera árbol levas	NB	1 400047
0490692	Conexión entrada agua	NB	1 400048
3683211	Succión aceite	NB	1 400249
0490024	Salida agua a tapa cilindros	NB	1 400052
006007	Filtro aceite a block	NB	1 400057
36885008	Turbo a múltiple escape	AC	1 350462
006074	Bomba alimentación	NB	1 400165
L 311 FF 02	Arandela inyector A 15.1 x 18 x 1.5 C	CU	4
	Kit de retenes completo		R400000-1
	Jgo. retén válvulas (8)	P	1 R400010P
	Jgo. retén válvulas (8)	P	1 R300310P
	Retén bancada 133.35 x 158.75 x 11/13	P	1 R400211P
	Retén distribución 60.32 x 79.36 x 9.5	P	1 R400012P

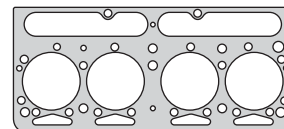

410808

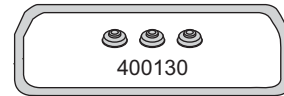

400130

400010

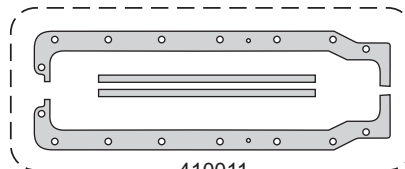

410011

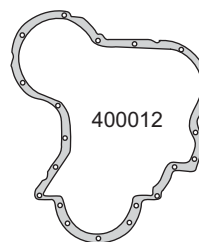

400012

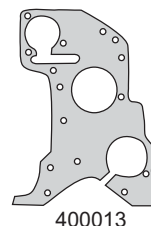

400013

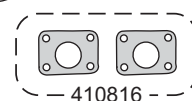

410816



400017



400014



300019



400034

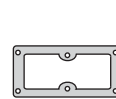

400036

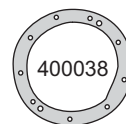

400038



400432



410834



410835



410836



410837



400039



410645



400048



400047



400246



400249



400052



400057



350462



400165



R400211P

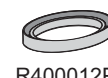

R400012P



R300310P



R400010P

MAXION/WWW/PERKINS

PERKINS



Motor/Engine	Cm³	HP	Ø
Prima 65/80T Leyland Prima 65 Daf TN 44	1994	64/80	84.45

Perkins: Rover - Maestro D/TD
Perkins - Marino 4.20 D/TD
Leyland Sherpa 185/200/215/220/230
240/255 1986/94
Daf Ka 200/ VS 200 1986/...



DIESEL

Nº OE	Descripción/Description	Mat.	Ref.
	Jgo. de juntas para motor		420600-R
L681EF06	Junta tapa de cilindro Ø 86 ± 1.50	NFT	1 420607
L681KF03	Junta para cárter	NB	1 420611
L687YF02	Frente motor para bomba aceite a block	NB	1 420612
L681VF02	Múltiple admisión y escape	NFT	1 420615
006155	Salida de escape	AC	1 420618
L683NF02	Retorno agua termostato	NB	1 420619
L687MF03	Conexión salida agua	NB	1 420621
L687MF13	Cuerpo salida agua a tapa de cilindros	NB	2 420622
L687MF05	Codo a múltiple admisión	NB	1 420623
006165	Caja drenaje aceite	NB	2 420624
L683NF02	Junta conexión salida agua	NB	2 420626
L683HF01	Junta carga aceite a block	NB	1 420627
L687MF14	Bomba aceite a cabezal	NB	1 420636
006167	Placa adaptador a block trasero	NB	1 420637
L683HF05	Tubo carga aceite a block	NB	1 420638
L688CF01	Turbo a salida escape	NFT	2 420639
	Entre múltiplo turbo	AC	1 500546
36862126	Bomba combustible	NB	400165
	Arandela A 6.5 x 10 x 1 C	CU	8
	Arandela A 8 x 11 x 1 A	AL	8
	Arandela A 8 x 14 x 1.5 C	CU	4
	Arandela A 20 x 26 x 1 A	AL	2
	Arandela A 14 x 20 x 1.5 C	CU	1
	Arandela A 20 x 25 x 2 A	AL	1
	Arandela A 14 x 18 x 1.5 A	AL	1
	O´ring G 47.29 x 2.62	GS	1
	O´ring G 20 x 2	GS	1
	Kit de retenes completo		R420600
	Jgo. retén válvulas (8)	P	1 R420610P
	Retén bancada 88. 9 x 105 x 9.5	P	1 R420611P
	Retén distribución 35 x 45 x 7	P	1 R420612P
	Retén árbol de levas trasero 40 x 52 x 7	P	1 R420613P
	Retén árbol de levas trasero 45 x 60 x 7	P	1 R420614P

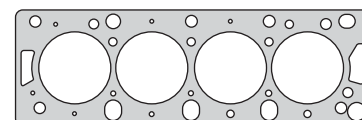

420607

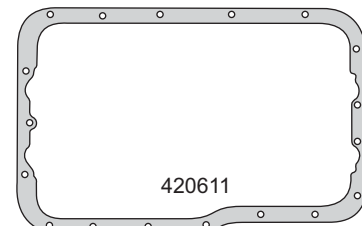

420611



420612

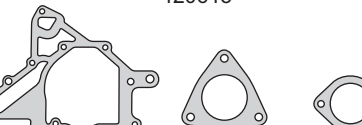

420615

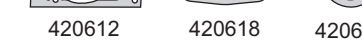

420618

420619



420621

420622

420623



420624

420626



420627

420636

500546

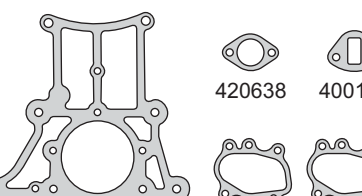

420637

420639



G 20 x 2

A 14 x 20 x 1.5 C

A 20 x 26 x 1 A



A 20 x 25 x 2 A

A 6.5 x 10 x 1 C

A 8 x 11 x 1 A



G 47.29 x 2.62

A 8 x 14 x 1.5 C

A 14 x 18 x 1.5 A



R420611P

R420614P

R420612P



R420610P

MAXION/WWW/PERKINS



taranto

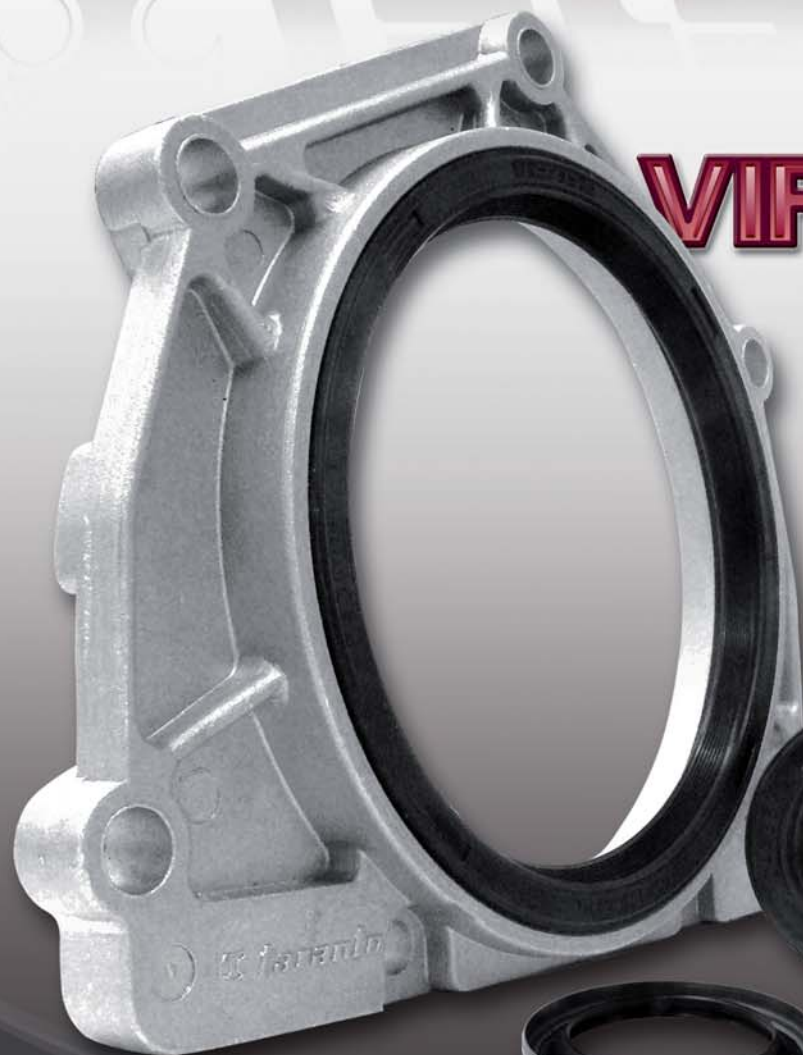

VIFLON®



Revolucionario diseño de labio en VIFLON® VF

Como resultado de la permanente búsqueda de mejores diseños y materiales para ofrecer al mercado productos más eficientes a costos razonables, Taranto ha desarrollado nuevos perfiles de labio con mejores características y costo más bajo que los retenes PTFE.

VENTAJAS DE ESTE NUEVO DISEÑO Y COMPUESTO

- ▶ Contacto más estrecho con el eje.
- ▶ Menor carga sobre el eje por su diseño sin resorte.
- ▶ Menor coeficiente de fricción respecto al compuesto fluoroelastómero FKM.
- ▶ Mejor flexibilidad del labio con una mejor adaptación a ejes usados.
- ▶ Menor costo respecto al PTFE.











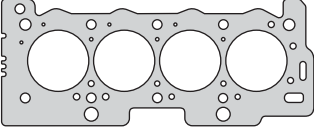



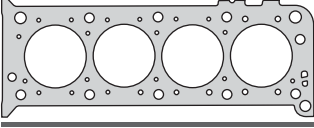

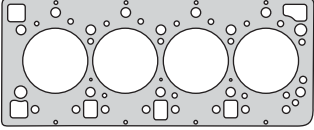

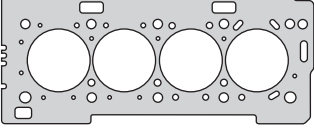

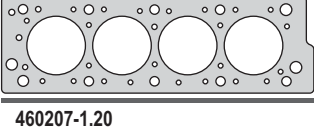



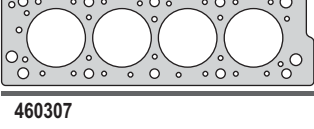

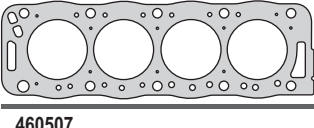

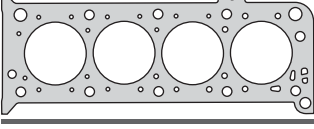
MOTORES NAFTA - DIESEL

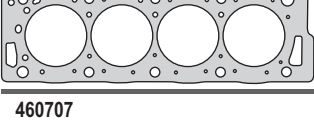







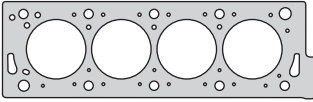
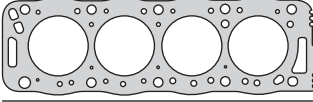
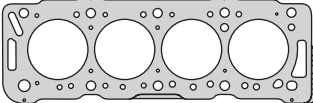
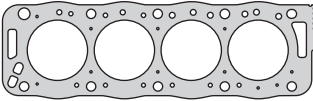
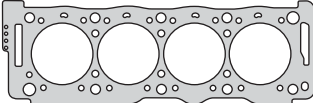
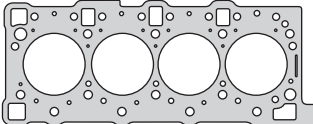
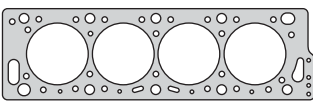
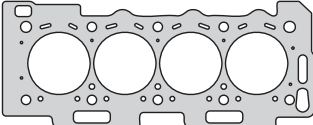
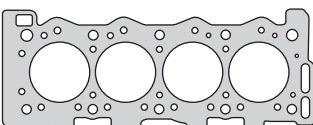
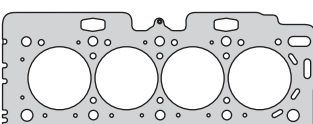

450005 - 450006 	Código	Ø	≡	Kit Bulón	Modelo
	450005 450006	86.5 86.5	1.40 2.40	B450000 (HAS19038)	404 1962/80 - 504 GLS/GLSE 1969/80
450205 - 450206 - 450207 	Código	Ø	≡	Kit Bulón	Modelo
	450205 450206 450207	86.5 86.5 86.5	1.40 2.40 1.40	B450200 (HAS19038)	504 - XE - XL - XSE 1973/78
450305 - 450306 - 450307 	Código	Ø	≡	Kit Bulón	Modelo
	450305 450306 450307	90.0 90.0 90.0	1.40 2.40 1.40	B450200 (HAS19038) B460200 (HAT55055) (HAT55100)	504 - TN - GES - XNA 1976/80 - 505 - 9R - J9/J5 1980/92
450407 	Código	Ø	≡	Kit Bulón	Modelo
	450407-1M 450407-2M 450407-3M 450407-4M	96.0 96.0 96.0 96.0	1.50 1.60 1.70 1.80	B450700 (HAS17038) B450700-1 (HAS12038)	XD2 504D 1976/93 - 505D 1979/82 - 505TD 1981/... - 604TD 1978/83 J7D 1977/... - J9D 1980/... - XD3 504 1987/... - 505 1982/93 - J9 1986/94
450507 	Código	Ø	≡	Kit Bulón	Modelo
	450507-1.50 450507-1.80	90.0 90.0	1.50 1.80	B450200 (HAS19038) B460200 (HAT55055) (HAT55100)	505 1983/86 - 504 1970/84 - 604 1982/86 - 505 1987/...
450905 - 450906 	Código	Ø	≡	Kit Bulón	Modelo
	450905 450906	82.0 82.0	1.40 2.40		403/7 1959/66 - 403/8 1955/67
451307 	Código	Ø	≡	Kit Bulón	Modelo
	451307	87.0	1.20	B460300 (HAT55055) (HAT55100)	605 1989/98 Citroën XM 1989/94 - 1990/93
451407 	Código	Ø	≡	Kit Bulón	Modelo
	451407	85.0	1.40	B460200 (HAE18038)	309 1989/93 - 405 1987/95 Citroën BX GTI 1987/93
451507 	Código	Ø	≡	Kit Bulón	Modelo
	451507	73.5	1.30	B470500 (HAE14038)	205 1987/93 - 106 1991/... - 106 - 306 - Partner 1996/... Citroën Saxo - Berlingo - ZX - Saxo 1996/... - C15 - AX 10 1986/...
451607 	Código	Ø	≡	Kit Bulón	Modelo
	451607	76.0	1.30	B470500 (HAE14038)	106 1991/96 - 309 1992/93 - 405 1993/94 - 205 1991/93 Citroën AX14 - BX14 - C15 1991/... - ZX - AX GT 1993/...
450005 - 450006 	Código	Ø	≡	Kit Bulón	Motor
	450005 450006	86.5 86.5	1.40 2.40	B450000 (HAS19038)	1618cc. XC7 - XC7P 59HP Ø84 (450000-R) pág. 338 1657cc. XC7 - XC6A 59HP Ø84 (450100-R) pág. 340
450205 - 450206 - 450207 	Código	Ø	≡	Kit Bulón	Motor
	450205 450206 450207	86.5 86.5 86.5	1.40 2.40 1.40	B450200 (HAS19038)	1796cc. XC7 - XM7 69/70HP Ø85 (450200-R) pág. 341
450305 - 450306 - 450307 	Código	Ø	≡	Kit Bulón	Motor
	450305 450306 450307	90.0 90.0 90.0	1.40 2.40 1.40	B450200 (HAS19038) B460200 (HAT55055) (HAT55100)	1971cc. XN1 - XN2 78/85HP Ø88 (450300-R) pág. 343 1971cc. GR/SR - XN1/XN2 85HP Ø88 (450500-R) pág. 347
450407 	Código	Ø	≡	Kit Bulón	Motor
	450407-1M 450407-2M 450407-3M 450407-4M	96.0 96.0 96.0 96.0	1.50 1.60 1.70 1.80	B450700 (HAS17038) B450700-1 (HAS12038)	2304cc. XD2 70/73HP Ø94 2498cc. XD3/X3DP 76/90HP Ø94 - DIESEL (450701-R) pág. 345
450507 	Código	Ø	≡	Kit Bulón	Motor
	450507-1.50 450507-1.80	90.0 90.0	1.50 1.80	B450200 (HAS19038) B460200 (HAT55055) (HAT55100)	1971cc. XN2/XN6 105HP Ø88 (450600-R) pág. 349 1971cc. XN1/XNA - Gamma 90HP Ø88 (450800-R) pág. 350
450905 - 450906 	Código	Ø	≡	Kit Bulón	Motor
	450905 450906	82.0 82.0	1.40 2.40		1290cc. 7CV 52HP Ø75 1468cc. 8CV 55/58HP Ø80 (450900-R) pág. 352
451307 	Código	Ø	≡	Kit Bulón	Motor
	451307	87.0	1.20	B460300 (HAT55055) (HAT55100)	1998cc. XU10M 107HP - XU102C 115HP - XU10J2 122/130HP Ø86 (451395-R) pág. 354
451407 	Código	Ø	≡	Kit Bulón	Motor
	451407	85.0	1.40	B460200 (HAE18038)	1905cc. XU9J4 147/155/160HP Ø83
451507 	Código	Ø	≡	Kit Bulón	Motor
	451507	73.5	1.30	B470500 (HAE14038)	954cc. TU9/M/MZ/K 41/45/50HP Ø70 1124cc. TU1M 54HP Ø72 (451500-R) pág. 355
451607 	Código	Ø	≡	Kit Bulón	Motor
	451607	76.0	1.30	B470500 (HAE14038)	1360cc. TU3F2 - TU3FM - TU3J2/Z - TU3MC (Motor con block de fundición gris) 75/94HP Ø75 (451600-R) pág. 356



MOTORES NAFTA - DIESEL

	451707 Código	Ø 76.0	∇ 1.30	Kit Bulón B470500 (HAE14038)	Modelo 106 1991/... - 206 1998/... - 306 1993/... - 405 - 205 1987/96 - 309 1988/93 Partner 1996/... - Partnet 2005/... - 206/307 2001/... Citroën BX 14 - C15 - AX 14/AX GT - ZX - Berlingo - Xsara - Saxo - C2/C3
	Motor 1124cc. TU1/K/Z/M 55/60HP Ø72 (451700-R)  pág. 357 1360cc. TU3/A/S/K/M/JP/MC 65/70/75/80HP Ø75 (451700-R)  pág. 357 1360cc. TU3JP (KFW/K6D) 75HP Ø75 (452200-R)  pág. 361				
	451807 Código	Ø 76.0	∇ 1.20	Kit Bulón	Modelo 104 1972/86 - 205 1983/86 - 104 1980/86 - 205 1983/86 Citroën Visa 11 1978/85 - C15 - Visa Super X - Visa GT - BX 14 1981/85
	Motor 954cc. XV3/XV5/XV8 45HP Ø70 - 1124cc. XW3 - /XW7 57HP Ø72 1219cc. XZ5 57HP Ø75 - 1360cc. XY6B/XY8 - XY6B/XY7 70HP Ø75 (451800-R)  pág. 366				
	452008 Código	Ø 93.0	∇ 1.40	Kit Bulón B452000 (HAE14038)	Modelo Boxer TDI 1997/... Citroën Jumper TDI - Relay TDI 1997/...
	Motor 2445cc. DJ5TED (THX) 107HP Ø92 - DIESEL (452000-R MLS)  pág. 359				
	452107 - 452108 Código	Ø 80.0 80.0	∇ 1.20 0.60	Kit Bulón B452100 (HAE14038)	Modelo 206 - 307 - Partner 2000/... - 207 SW - 207 Compact Citroën Berlingo - C3 Pluriel - Xsara 2000/... - C2 - C3 2002/... - 2004/...
	Motor 1587cc. TU5JP4 (NFU/N6A) 106/109HP Ø78.5 (452100-R MLS)  pág. 360				
	460205 - 460207 Código	Ø 84.0 84.0	∇ 1.40 1.40	Kit Bulón B460100 (HAE14038) B460200 (HAT55055) (HAT55100)	Modelo 309GT - 305GTX 1986/93 - 306/405/406 1992/... - 406 - Partner 1997/... Citroën Xantia - Xsara - Berlingo 1997/... - BX19 - BX19 GTI 1983/93
	Motor 1761cc. XU7JP-XU7JB 90/103HP Ø83 (460100-R)  pág. 362 1761cc. XU7JB 90HP Ø83 (461100-R)  pág. 371 1905cc. XU92C 98/102HP Ø83 (460200-R)  pág. 363				
	460207-1.20 Código	Ø 84.0	∇ 1.20	Kit Bulón B460200 (HAT55055) (HAT55100)	Modelo 305 1982/91 - 205 1984/96 - 309 1985/94 - 405 1987/95 - Partner 1997/... Citroën BX16/BX16 GTI 1985/93 - Visa GTI 1985/... BX19/BX 19 GTI 1984/93 - Berlingo 1997/...
	Motor 1580cc. XU5 75/80/90HP Ø83 1905cc. XU9 102/110/125/130HP Ø83 (451295-R)  pág. 353				
	460307 Código	Ø 84.0 84.0 84.0 84.0	∇ 1.50 1.60 1.70 1.80	Kit Bulón B460300 (HAT55055) (HAT55100)	Modelo 306 1993/99 - 405 1988/95,1995/... - 305 - 309 1982/93 - 205 Express 1987/94 - Boxer - Expert - Partner 1995/... Citroën Xantia - Relay - Jumper - Jumpy - Berlingo - Xsara 1993/...
	Motor 1905cc. XUD9 64/69/71/90HP Ø83 - DIESEL (460301-R)  pág. 364				
	460507 Código	Ø 76.5	∇ 1.25	Kit Bulón	Modelo 205 1986/87 - 205 1986/87 - 104 1986/... Citroën C15 - Visa 11 - Visa GT - BX14 1985/... - Visa 10 1986/88
	Motor 954cc. XV8 45HP Ø70 - 1124cc. XW7 55/57HP Ø72 1360cc. XY6B - XY7/XY8 70HP Ø75 (460500-R)  pág. 366				
	460607 Código	Ø 87.0	∇ 1.50	Kit Bulón B460300 (HAT55055) (HAT55100)	Modelo 405 1992/... - 306 1993/... - 406 - 605 - 806 Turbo 1996/... Citroën ZX 1992/96 - Xantia 1993/98
	Motor 1998cc. XU10J2C (RFX) 123HP Ø86 (451995-R)  pág. 358 1998cc. XU10 J2TE 150HP Ø86 (460400-R)  pág. 365 1998cc. XU10J2C 123HP Ø86 (460600-R)  pág. 367				
	460707 Código	Ø 76.0	∇ 1.40	Kit Bulón B470500 (HAE14038)	Modelo 106 1991/... - 306 1993/97 - 205 1987/96 - 205 Rallye 1988/93 Partner 1996/... - 306 1993/... - 405 1987/96 - 309 1988/93 - 206 1998/... Citroën BX 14 - C15 - Saxo - AX 14/AX GT - ZX - Saxo - Xsara 1996/...
	Motor 1124cc. TU1M/K/Z 55/60HP - 1294cc. TU24 102HP Ø75 1360cc. TU3JP/S/M/MC/K/A - TU3.2 65/75/80HP Ø75 (460700-R)  pág. 368				

MOTORES NAFTA - DIESEL







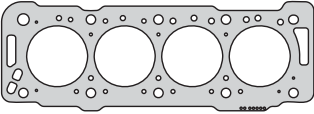
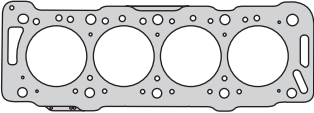
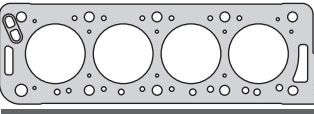
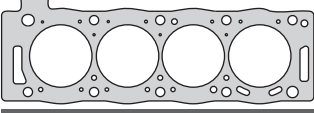
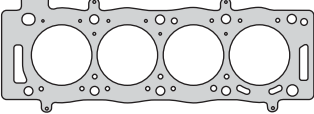
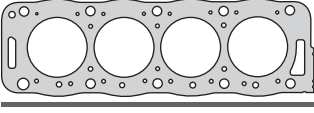
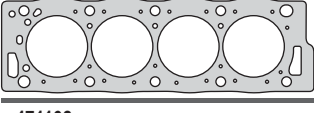
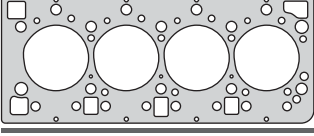
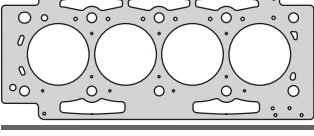
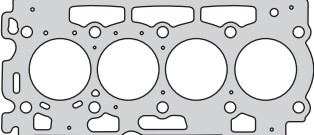



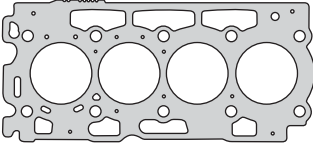

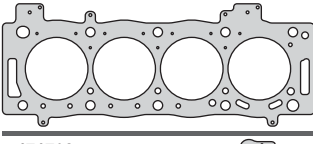

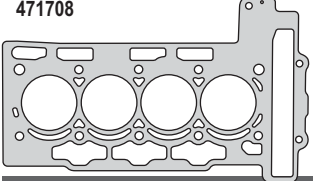
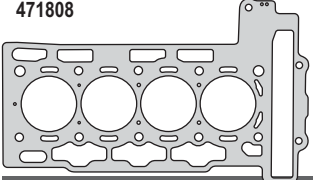
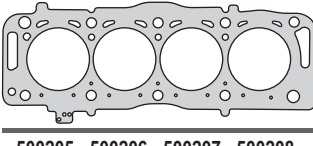

460807 	Código	Ø	≠	Kit Bulón	Modelo
	460807	84.0	1.40	B460800 (HAE14038)	306 1997/... - 406 1995/96 - 406 1997/... Citroën Xsara 1997/... - Xantia 1995/96 - Xantia 1997/2001 - ZX 1997/98
460907 	Código	Ø	≠	Kit Bulón	Modelo
	460907-1M 460907-2M 460907-3M	84.0 84.0 84.0	1.50 1.60 1.70	B460900 (HAT55055) (HAT55100)	306 TD - 405 TD 1992/97 - 406 TD - 806TD - Expert TD - Boxer TD 1995/... Citroën Xantia TD - ZX TD 1993/... - Dispatch TD - Jumper TD Jumpy TD 1995/... - Xsara TD 1997/...
460908 	Código	Ø	≠	Kit Bulón	Modelo
	460908-1M 460908-2M 460908-3M 460908-4M 460908-5M	84.0 84.0 84.0 84.0 84.0	1.34 1.38 1.42 1.50 1.55	B460900 (HAT55055) (HAT55100)	306 TD - 405 TD 1992/97 - 406 TD - 806TD - Expert TD - Boxer TD 1995/... Citroën Xantia TD - ZX TD 1993/... - Dispatch TD - Jumper TD Jumpy TD 1995/... - Xsara TD 1997/...
461307 	Código	Ø	≠	Kit Bulón	Modelo
	461307-1M 461307-2M 461307-3M 461307-4M 461307-5M	84.0 84.0 84.0 84.0 84.0	1.36 1.40 1.44 1.48 1.52	B460300 (HAT55055) (HAT55100)	306 - 405 - Boxer - Partner - Expert 1995/... - Hyundai Lantra 1998/... Citroën Dispatch - Relay - Jumpy - Xsara - Berlingo - ZX 1995/99 Fiat Escudo, Ducato 1994/01 - Suzuki Vitara 1995/96
461508 	Código	Ø	≠	Kit Bulón	Modelo
	461508-1M 461508-2M 461508-3M 461508-4M 461508-5M 461508-SM	85.0 85.0 85.0 85.0 85.0 85.0	1.52 1.57 1.62 1.67 1.72 1.77	B461500 (HAE14038)	605 TD 1990/98 - 1995/98 - 406 TD 1995/... - 806 TD 1996/... Citroën XM TD 1989/00 - Xantia TD 1995/98 - Dispatch TD - Evasion TD Jumper TD - Jumpy TD - Synergie1996/99
470007 	Código	Ø	≠	Kit Bulón	Modelo
	470007	93.0	1.60	B470000 (HAE14038)	Boxer D/TD 1994/... - 605 TD 1995/99 Citroën Jumper D/TD - XM TD - Relay D/TD1994/97
470207 	Código	Ø	≠	Kit Bulón	Modelo
	470207	87.0	1.40	B470200 (HAT55055) (HAT55100)	405 MI - 405 TI Turbo 1992/95 - 306 1993/... Citroën ZX 1992/97 - Xantia 1993/95
470307 - 470308 	Código	Ø	≠	Kit Bulón	Modelo
	470307 470308	78.0 78.0	1.80 1.60	B470300 (HAE14038)	106 1994/... Citroën AX 15 1994/97 - Saxo 1996/...
470407 - 470408 	Código	Ø	≠	Kit Bulón	Modelo
	470407 470408	76.0 76.0	1.80 1.70	B470400 (HAE14038)	106 1992/95 Citroën AX 14 1988/94
470508 	Código	Ø	≠	Kit Bulón	Modelo
	470508-1.40 470508-1.60	81.5 81.5	1.40 1.60	B470500 (HAE14038)	106 1994/... - 306 1993/... - 206 1998/... Citroën ZX - Saxo 1996/... - Xsara 1997/...
					Motor
					1761cc. XU7JP4 (DOHC) 16V 112HP Ø83 (460800-R)  pág. 369
					Motor
					1905cc. XUD9TE - XUD9SD/TF - XUD9TF - XUD9UTF 76/90/92HP Ø83 DIESEL (460301-R)  pág. 370
					Motor
					1905cc. XUD9TE - XUD9SD/TF - XUD9TF - XUD9UTF 76/90/92HP Ø83 DIESEL (460301-R)  pág. 370
					Motor
					1905cc. XUD9 65/69HP Ø83 - DIESEL
					Motor
					2088cc. XUD11ATE/BTE 12V 110HP Ø85 - DIESEL (461501-R)  pág. 373
					Motor
					Motor
					2445cc. DJ5 (T9A) - DK5ATE - DJ5T(T8A/THZ) 86/103/130HP Ø92 DIESEL (470000-R)  pág. 374
					Motor
					Motor
					1998cc. XU10J4 152/155HP - XU10J4TE 200HP Ø86 (470200-R)  pág. 375
					Motor
					Motor
					1527cc. TUD5 (VJZ) 55/58HP Ø77 - DIESEL (470300-R)  pág. 376
					Motor
					Motor
					1360cc. TUD3 50HP Ø75 - DIESEL (470400-R)  pág. 377
					Motor
					Motor
					1587cc. TU5JP/J2 90/103HP Ø78.5 (470501-R)  pág. 378

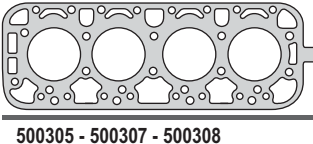

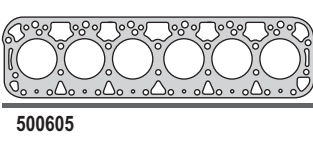
MOTORES NAFTA - DIESEL

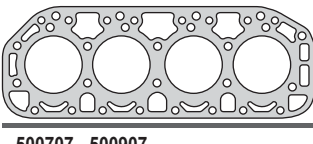
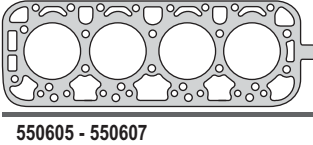
	470607	Código	Ø	≠	Kit Bulón	Modelo	206 - 306 1998/... - Expert - Partner 1999/... Citroën Berlingo - Jumpy - Xsara 1998/... - C5 - Xsara - Jumpy 2000/...
	470607-1M	84.0	1.26	B470600 (HAE14038)	Motor		
	470607-2M	84.0	1.30				
	470607-3M	84.0	1.34				
	470607-4M	84.0	1.38				
470607-5M	84.0	1.42					
	470608	Código	Ø	≠	Kit Bulón	Modelo	206 - 306 1998/... - Expert - Partner 1999/... Citroën Berlingo - Jumpy - Xsara 1998/... - C5 - Xsara - Jumpy 2000/...
	470608-1M	84.0	1.26	B470600 (HAE14038)	Motor		
	470608-2M	84.0	1.30				
	470608-3M	84.0	1.34				
	470608-4M	84.0	1.38				
470608-5M	84.0	1.42					
	470707	Código	Ø	≠	Kit Bulón	Modelo	205 TD 1990/96 - 405 TD 1988/94 - 309 TD 1990/93 Citroën BX 17 TD 1988/94
	470707-2M	82.0	1.65	B470700 (HAT55055) (HAT55100)	Motor		
	470707-3M	82.0	1.80				
	470807	Código	Ø	≠	Kit Bulón	Modelo	306/406 HDI - 206/806 HDI - Boxer HDI - Expert HDI - Partner HDI 1998/... 307 - 607 2000/... - Citroën Xantia HDI - Jumper HDI - Xsara HDI 1998/... Evasion HDI - Xsara Picasso HDI - Dispatch HDI - Jumper HDI
	470807-1M	86.0	1.30	B470800 (HAE14038)	Motor		
	470807-2M	86.0	1.35				
	470807-3M	86.0	1.40				
	470807-4M	86.0	1.45				
470807-5M	86.0	1.50					
	470808	Código	Ø	≠	Kit Bulón	Modelo	306/406 HDI - 206/806 HDI - Boxer HDI - Expert HDI - Partner HDI 1998/... 307 - 607 2000/... - Citroën Xantia HDI - Jumper HDI - Xsara HDI 1998/... Evasion HDI - Xsara Picasso HDI - Dispatch HDI - Jumper HDI
	470808-1M	86.0	1.30	B470800 (HAE14038)	Motor		
	470808-2M	86.0	1.34				
	470808-3M	86.0	1.38				
	470808-4M	86.0	1.42				
470808-5M	86.0	1.50					
	470907	Código	Ø	≠	Kit Bulón	Modelo	205 - 309 1983/96 - 306 1993/... - Partner 1996/... Citroën C15 1994/... - Berlingo 1996/99 - Xsara 1997/... - ZX 1991/94
	470907-1M	82.0	1.36	B460300 (HAT55055) (HAT55100)	Motor		
	470907-2M	82.0	1.40				
	470907-3M	82.0	1.44				
	470907-4M	82.0	1.48				
	470907-5M	82.0	1.52				
470907-6M	82.0	1.80					
	471007	Código	Ø	≠	Kit Bulón	Modelo	406 - 605 1995/... - 306 1997/... - 806 1998/01 Citroën Xantia 1995/01 - Xsara 1998/00 - Evasion - Synergie 1998/...
	471007	87.0	1.20	B471000 (HAE14038)	Motor		
	471108	Código	Ø	≠	Kit Bulón	Modelo	Boxer TDI 1997/... Citroën Jumper TDI - Relay TDI 1996/00
	471108	93.0	1.40		Motor		
	471207 - 471208	Código	Ø	≠	Kit Bulón	Modelo	206/307/806/807 - Expert 2000/... - 406 HPIV - 607 2001/... - 407 2004/... Citroën Jumpy - Dispatch - Xsara - Evasion 98/... - C5 - C5 HPI 2001/... C8 2002/... - C4 2004/... - Xsara Picasso
	471207	86.0	1.20	B471200 (HAE14038)	Motor		
	471208	85.5	0.65				
	471307	Código	Ø	≠	Kit Bulón	Modelo	307 HDI - 407 TD 2004/... - 207 Compact Citroën Xsara - Picasso TD 1999/... - C4/C5 TD 2004/...
	471307-1M	76.0	1.20	B302100 (HAE14038)	Motor		
	471307-2M	76.0	1.30				
	471307-3M	76.0	1.40				
	471307-4M	76.0	1.45				
471307-5M	76.0	1.50					

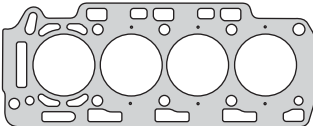
MOTORES NAFTA - DIESEL

	471308			Código	Ø	Δ	Kit Bulón	Modelo
	471308-1M	76.0	1.25	B302100 (HAE14038)	Modelo	307 HDI - 407 TD 2004/... - 207 Compact Citroën Xsara - Picasso TD 1999/... - C4/C5 TD 2004/...		
	471308-2M	76.0	1.30					
	471308-3M	76.0	1.35					
	471308-4M	76.0	1.40					
471308-5M	76.0	1.45	Motor			1560cc. DV6TED4 109HP - DV6TED4(9HZ) 108HP (DOHC) 16V Ø75 DIESEL (471301-R)  pág. 385		
	471408			Código	Ø	Δ	Kit Bulón	Modelo
	471408-1M	86.0	1.25	B470800 (HAE14038)	Modelo	307 HDI FAP - 407 HDI 2003/... - Expert HDI 2007/... - 807 HDI 2006/... 406/607/806/807 HDI - Expert HDI 1999/... - Citroën C4/C5 - Evasion HDI C8 HDI, Jumpy HDI 2001/... - C4 Picasso HDI - C4/C8 HDI FAP 2006/...		
	471408-2M	86.0	1.30					
	471408-3M	86.0	1.35					
	471408-4M	86.0	1.40					
			Motor			1997cc. DW10BTED4 (RHR/RHK) 136HP Ø85 - DIESEL (471401-R)  pág. 386 1997cc. DW10ATED4 (RHW/RHT) 109HP Ø85 - DIESEL (471501-R)  pág. 387 2179cc. DW12TED4 (4HX) 133HP Ø85 - DIESEL (471501-R)  pág. 387		
	471708			Código	Ø	Δ	Kit Bulón	Modelo
	471708	78.0	0.90		Modelo	207/207 SW - 308/308 SW 2007/... - Partner 2008/... - 3008, 5008 2009/... Citroën C3 Picasso - C3 2009/... - DS3 2010/... - C4/C4 Coupe C4/C3 Picasso 2008/..., Berlingo, C3 2009/..., DS3 2010/...		
	471808			Código	Ø	Δ	Kit Bulón	Modelo
	471808	78.0	0.90		Modelo	207/207 CC - 308/308 SW 2007/... - 3008 2009/... - 508/508 SW -5008 RCZ 2010/... - Citroën C4/C4 Grand Picasso - C4 Picasso 2008/... - C5 C5 Tourer 2009/... - DS3 2010/...		
	471908			Código	Ø	Δ	Kit Bulón	Modelo
	471908-1M	86.0	1.25	B470800 (HAE14038)	Modelo	308 HDI -308 SW HDI 2007/... - 308 CC HDI - 407 Coupe HDI - 3008 HDI 407 HDI - 407 SW HDI - 5008 HDI - Expert Tepee - Expert 3 2009/... Citroën C5 - C5 HDI - C5 Tourer HDI 2009/... - C4 Picasso 2010/...		
	471908-2M	86.0	1.30					
	471908-3M	86.0	1.35					
	471908-4M	86.0	1.40					
			Motor			1997cc. DW10CTED4 (RH02/RHH) (DOHC) 16V 150/163HP Ø85 - DIESEL (471901-R)  pág. 390		
	500205 - 500206 - 500207 - 500208			Código	Ø	Δ	Kit Bulón	Modelo
	500205	92.0	1.40	B500200 (HAS17038)	Modelo	404 - T4B - T5B - Rastrojero 1972/...		
	500206	92.0	2.40					
	500207	92.0	1.40					
	500208	92.0	1.70					
			Motor			1948cc. XD/XDP 4.88 50/59HP Ø88 - DIESEL (500200-R)  pág. 391		
	500305 - 500307 - 500308			Código	Ø	Δ	Kit Bulón	Modelo
	500305	94.0	1.40	B500300	Modelo	Pick Up - Camiones Livianos 1976/...		
	500307	94.0	1.40					
			Motor			3168cc. XDP 6.90 95HP Ø90 - DIESEL (500300-R)  pág. 393		
	500605			Código	Ø	Δ	Kit Bulón	Modelo
	500605	94.0	1.70	B500200 (HAS17038)	Modelo	504 1980/... - J7/J9 1980/87 - Adaptables Pick Up		
	500707 - 500907			Código	Ø	Δ	Kit Bulón	Modelo
	500707	98.5	1.40	B500200 (HAS17038)	Modelo	404 - T4B - T5B - Rastrojero 1972/...		
	500907	92.0	1.40					
			Motor			1948cc. XD/XDP 4.88 50/59HP Ø88 - DIESEL (500200-R)  pág. 391		
	550605 - 550607			Código	Ø	Δ	Kit Bulón	Modelo
	550605	89.0	1.40	B461200 (HAS19038)	Modelo	505 Inyección ZEJ - 1979/... - 505 GTI ZDJ - 1982/91		
	550607	89.0	1.20					
			Motor			1995cc. ZEJ 110HP Ø88 2165cc. ZDJ 123HP Ø88 (461200-R)  pág. 372		

CITROËN



Motor/Engine	Cm³	HP	Ø
A 79/0	425	24	66

Citroën: 2CV - AZ - AZAM - AZN - AZU - AZUB
1966/68



Nº OE	Descripción/Description	Mat.	Ref.
	Jgo. de juntas para motor		150000-R
A-132-3	Junta tapa válvulas	GS 2	150010
AM-141-2A	Jgo. múltiple escape (2)	FCH 1	150015
	Jgo. juntas carburador	VS	150020
54-590	Base carburador	NB 2	150025
	Tapa carburador	CB	150026
	Bomba aceite	CB 1	150027
	Junta bomba de nafta	NB	150028
	Bomba nafta	NB 2	550428
	Arandela tapón cárter B 16 x 22 x 3 CN	CU	150029
	Arandela doble racord	CU 2	150031
	Arandela flexible frenos A 13 x 18 x 1	CU	150032
	Arandela flexible frenos A 10.2 x 18	CU	150033
	Arand. radiador aceite chica B 14 x 18 x 2 CN	CN	150034
	Arand. radiador aceite grande B 16 x 22 x 2.4 CN	CN	150035
	Arandela culata cilindros A 8 x 14 x 1 C	CU 4	150036
	Arand. tapón cárter supermed. A 18 x 23 x 1C	CU	150037
A-221-92	Tubo llenado	NB 1	150038
	Tapa platino	CG 1	150039
	Tambor frenos	CB	150040
	Tambor frenos	NB	150041
	Bomba aceite	NB	150042
AW-331-86	Salida caja 4 agujeros	CB	150043
A-224-956	Envolverte varilla balancines	GS 2	150044
	Arandela bulbo presión aceite A 12 x 16 x 1C	CU	150045
	Brazo suspensión	CB	150046
A-331-7	Cárter caja velocidades	CG 1	150050
	Arandela A 14 x 18 x 1.5 A	AL 4	
	Arandela A 16 x 22 x 1.5 A	AL 1	
	Kit de retenes completo		R150000
	Jgo. retén válvulas (4)	P 1	R150010P
	Retén bancada 48 x 65 x 10	N 1	R150011N
	Retén distribución 30 x 42.04 x 8	N 1	R150012N

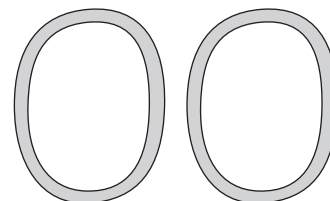

150010

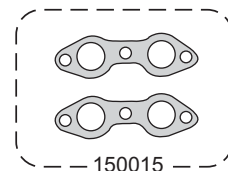

150015

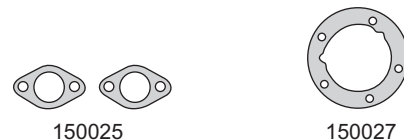

150025

150027



550428

150031



150038

150039

150044

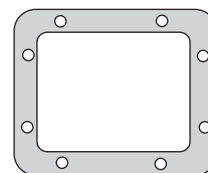

150050



A 14 x 18 x 1.5 A

A 8 x 14 x 1C



A 16 x 22 x 1.5 A

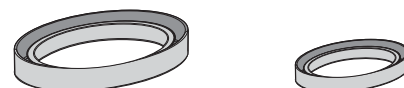

R150011N

R150012N

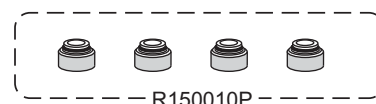

R150010P

CITROËN



Motor/Engine **Cm³** **HP** **Ø**

A 79/1 **425** **28** **66**

Citroën: 2CV - AZL 1968/69

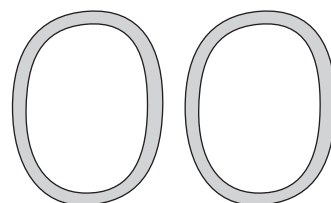

150010

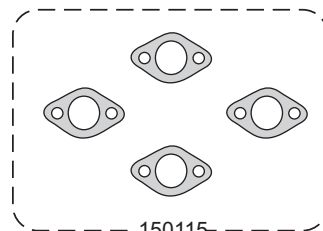

150115

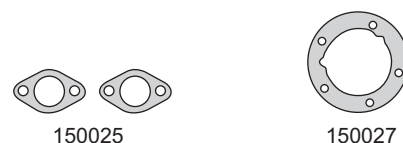

150025

150027

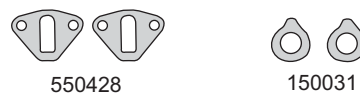

550428

150031

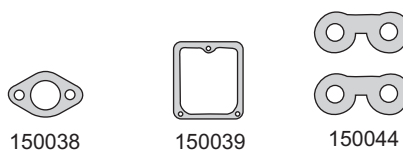

150038

150039

150044

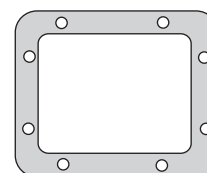

150050



A 14 x 18 x 1.5 A

A 8 x 14 x 1C



A 16 x 22 x 1.5 A



R150011N

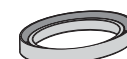

R150012N

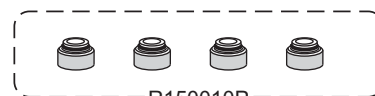

R150010P

Nº OE	Descripción/Description	Mat.	Ref.
	Jgo. de juntas para motor		150100-R
A-132-3	Junta tapa válvulas	GS	2 150010
AM-141-2A	Jgo. múltiple escape (4)	FCH	1 150115
	Jgo. juntas carburador	VS	150020
54-590	Base carburador	NB	2 150025
	Tapa carburador	CB	150026
	Bomba aceite	CB	1 150027
	Bomba nafta	NB	2 550428
	Arandela tapón cárter B 16 x 22 x 3 C	CU	150029
	Arandela doble raccord	CU	2 150031
	Arandela flexible frenos A 13 x 18 x 1 C	CU	150032
	Arandela flexible frenos A 10 x 18 x 1 C	CU	150033
	Arand. radiador aceite chica B 14 x 18 x 2 CN	CN	150034
	Arand. rad. aceite grande B 16 x 22 x 2.4 CN	CN	150035
	Arandela culata cilindros A 8 x 14 x 1 C	CU	4 150036
	Arand. tapón cárter supermedida A 18 x 23 x 1C	CU	150037
A-221-92	Tubo llenado	NB	1 150038
	Tapa platino	CG	1 150039
	Tambor frenos	CB	150040
	Tambor frenos	NH	150041
	Bomba aceite	NH	150042
AW-331-86	Salida caja 4 agujeros	CB	150043
A-224-956	Envolvente varilla balancines	GS	2 150044
	Arandela bulbo presión aceite A 12 x 16 x 1 C	CU	150045
	Brazo suspensión	CB	150046
A-331-7	Cárter caja velocidades	CG	1 150050
	Arandela A 14 x 18 x 1.5 A	AL	4
	Arandela A 16 x 22 x 1.5 A	AL	1
	Kit de retenes completo		R150000
	Jgo. retén válvulas (4)	P	1 R150010P
	Retén bancada 48 x 65 x 10	N	1 R150011N
	Retén distribución 30 x 42.04 x 8	N	1 R150012N

CITROËN



Motor/Engine Cm³ HP Ø

M28/0 - M28/1 602 35 74

Citroën: 3CV 1969/78



Nº OE	Descripción/Description	Mat.	Ref.
	Jgo. de juntas para motor		150200-R
AM-132-3A	Junta tapa válvulas	GS 2	150210
AM-141-2E	Jgo. múltiple escape (2)	NB 1	150215
AM-141-2D	Jgo. múltiple admisión (2)	NB 1	150217
	Jgo. juntas carburador 1ra. Serie	VS	150220
	Jgo. juntas carburador 2da. Serie	VS	150221
58-113	Base carburador	NB 1	150225
	Tapa carburador 1ra. Serie	CB	150226
AM-222-17	Bomba aceite	NB 1	150027
	Bomba nafta	NB 2	550428
	Arandela doble racord	CU 3	150031
	Tapa carburador 2da. Serie	CB	150231
	Base carburador	NH	150232
	Jgo. juntas admisión y escape	NH	150233
	Arandela culata cilindros A 8 x 14 x 1 C	CU 6	150036
AM-221-923	Tubo llenado	NB 1	150338
	Tapa platino	CG 1	150039
	Mandíbula	CB	150241
	Mandíbula	NH	150242
AM-224-95B	Envolvente varilla balancines	GS 2	150244
	Tubo radiador aceite	GS 2	150245
	Tamiz aceite G 54 x 2	GS 1	150246
	Bomba aceite G 12.42 x 1.78	GS 1	150247
A0331-07	Cárter caja velocidades	CG 1	150050
	Kit de retenes completo		R150200
	Jgo. retén válvulas (4)	P 1	R150010P
	Retén bancada 55.95 x 69.1/70 x 10	N 1	R150211N
	Retén distribución 30 x 42.04 x 8	N 1	R150012N

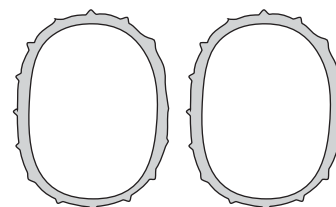

150210

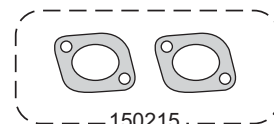

150215

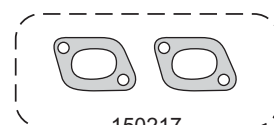

150217

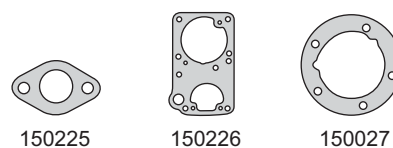

150225

150226

150027

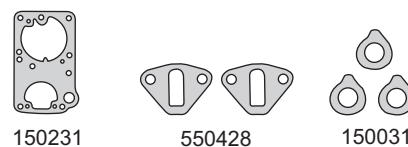

150231

550428

150031

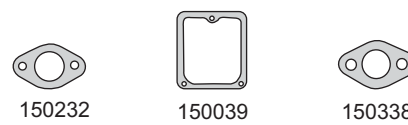

150232

150039

150338



150244

150245

G 54 x 2

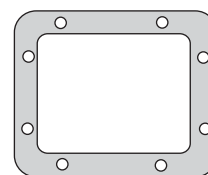

150050



G 12.42 x 1.78



A 8 x 14 x 1C



R150211N



R150012N

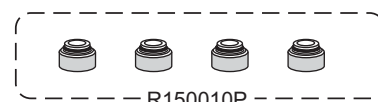

R150010P

CITROËN



Motor/Engine **M28/0 - M28/1** **602** **33** **74**

Citroën: Ami 8 - Mehari - Dyane - 3CV



Nº OE	Descripción/Description	Mat.	Ref.
	Jgo. de juntas para motor		150300-R
AM-132-3A	Junta tapa válvulas	GS 2	150210
AM-141-2E	Jgo. múltiple escape (2)	NB 1	150215
AM-141-2D	Jgo. múltiple admisión (2)	NB 1	150217
	Jgo. juntas carburador 1ra. Serie	VS	150320
	Jgo. juntas carburador 2da. Serie	VS	150321
58-113	Base carburador	NB 1	150225
	Base carburador	CB 2	150325
	Tapa carburador 1ra. Serie	CB	150326
AM-222-17	Bomba aceite	CB 1	150027
	Bomba nafta	NB 2	550428
	Arandela doble racord	CU 3	150031
	Base carburador	NH	150331
	Tapa carburador 2da. Serie	CB	150332
	Jgo. juntas admisión y escape	NH	150233
	Arandela culata cilindros A 8 x 14 x 1 C	CU 6	150036
AM-221-923	Tubo llenado	NB 1	150338
	Tapa platino	CG 1	150039
AM-224-95B	Envolvente varilla balancines	GS 2	150244
	Salida caja 6 agujeros	CB	150344
	Tubo radiador aceite	GS 2	150245
	Salida caja 6 agujeros	NH	150345
	Tamiz aceite G 54 x 2	GS 1	150246
	Bomba aceite G 12.42 x 1.78	GS 1	150247
A-331-7	Cárter caja velocidades	CG 1	150050
	Kit de retenes completo		R150200
	Jgo. retén válvulas (4)	P 1	R150010P
	Retén bancada 55.95 x 69.1/70 x 10	N 1	R150211N
	Retén distribución 30 x 42.04 x 8	N 1	R150012N

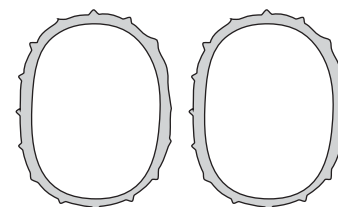

150210

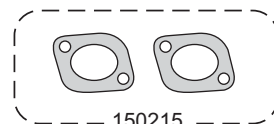

150215

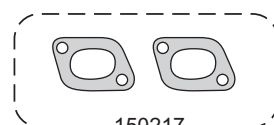

150217

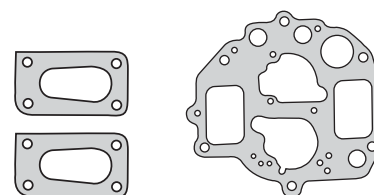

150325

150326

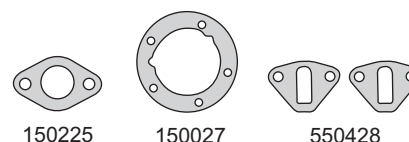

150225

150027

550428

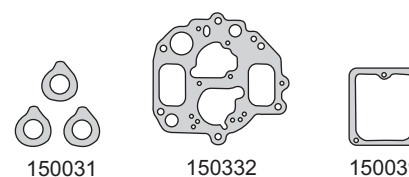

150031

150332

150039

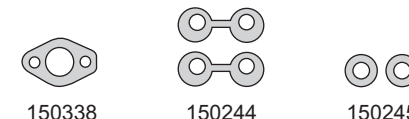

150338

150244

150245

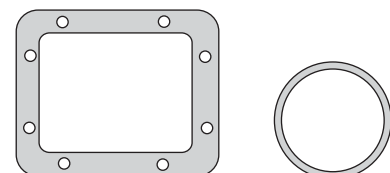

150050

G 54 x 2



A 8 x 14 x 1C

G 12.42 x 1.78

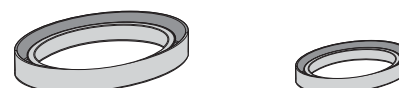

R150211N

R150012N

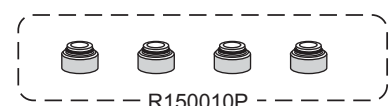

R150010P

PEUGEOT



Motor/Engine	Cm ³	HP	Ø
XC7 - XC7P	1618	59	84

Peugeot: 404 1962/80



Nº OE	Descripción/Description	Mat.	Ref.
0199.421	Jgo. de juntas para motor		450000-R
0199.414	Jgo. de juntas superior	●	450095
0203.240	Junta tapa cilindros Ø 86.5 ± 1.40	NFT 1 1	450005
0203.240	Junta tapa cilindros Ø 86.5 ± 2.40	NFT	450006
	Jgo. tornillos tapa cilindros (HAS19038)		B450000
0249.140	Conj. junta tapa válvulas (11)	N 1 1	450010
0304.030	Junta para cárter	CG 1	450011
0321.110	Tapa distribución	CG 1	450012
0321.110	Tapa distribución	CG	450112
0322.040	Placa distribución	CB 1	450013
1206.080	Bomba de agua	NB 1 1	450014
0349.030	Jgo. múltiple escape (4)	FCH 1 1	450015
0348.060	Múltiple admisión	NB 1 1	450017
1710.070	Salida de escape 1B	FCH 1 1	450018
1710.100	Salida de escape 2B	FCH 1 1	450118
1410.070	Jgo. juntas carburador SOLEX 34 PBICA	VS	450020
1406.340	Base carburador	NB 1 1	450025
1406.120	Tapa carburador	CB	450026
1104.040	Bomba aceite a block	CB 1	450027
1451.031	Base bomba nafta	CB 2	450028
0313.020	Arandela tapón cárter B 18 x 24 x 2.3 CN	CN	450029
	Arandela blindada B 16 x 22 x 2.4 CN	CN	450229
1166.020	Arandela cañería aceite a tapa cilin. A 8 x 14 x 1 C	CU 4 4	450030
1458.030	Tapa bomba nafta	CG	450031
1179.060	Tubo llenado aceite	CG 1	450032
0213.030	Arandela capuchón bujías	GS 4 4	450033
0253.050	Tubo separador balancines	GS 2 2	450034
	Respiradero carter	CG 1	500234
0127.050	Bastón retén bancada	GS 2	450035
6462.070	Grifo calefactor	NB	450036
1474.030	Cuerpo bomba nafta	CG	450037
5907.001	Base distribuidor	CB 1	450038
1031.030	Tórico bomba aceite G 12.42 x 1.78	GS 1	450039
1458.030	Vaso nafta	CG 1	450041
1528.070	Flotante tanque nafta	CG	450042
1451.031	Base bomba nafta	NB	450043
	Avance distribuidor	NB	450044
1912.001	Vaso filtro nafta	CG	450045
1104.040	Bomba aceite a block	NB 1	450048
2599.160	Jgo. juntas caja velocidades C3B	CB	450050
	Jgo. juntas caja velocidades BA7 71/...	CB	450350
	Tapa trasera s/fin diferencial	CB	450054
	Jgo. juntas diferencial 62/67 (4)	CB	450055
	Jgo. juntas diferencial 67/80 (4)	CB	450155
3040.071	Tubo empuje 62/67	CB	450056
3040.072	Tubo empuje 67/80	CB	450156
4222.060	Palier	CB	450057
	Cierre diferencial ancha 62/7	CB	450059
0304.030	Junta para cárter	CG	450060
	Cierre diferencial angosta 62/7	CB	450062
0112.170	Jgo. suplemento camisas cilindros (4)	GS 1	450070
	Suplemento tapa cilindros	AL	450085
	Arandela A 16 x 22 x 1.5 A	AL 1	

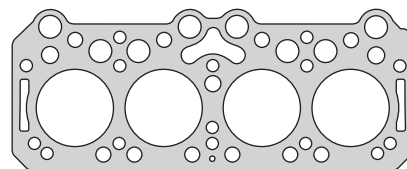

450005

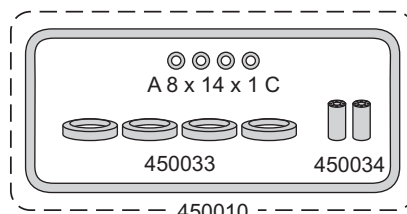

450010

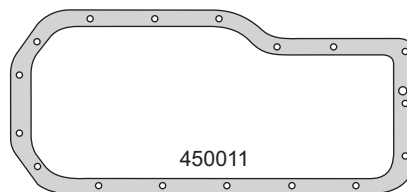

450011

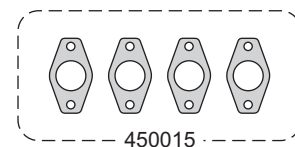

450015

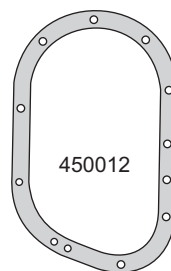

450012

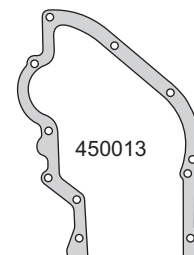

450013



450014

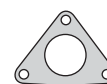

450017



450018



450118



450025

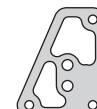

450027



450032



450028



500234



450035



450036



450037



450038



450048



450041

PEUGEOT



Motor/Engine	Cm³	HP	Ø
XC7-XC6A	1657	59	85

Peugeot: 504 GLS/GLSE 1969/80



Nº OE	Descripción/Description	Mat.	Ref.
	Jgo. de juntas para motor		450100-R
	Jgo. de juntas superior	●	450195
0203.240	Junta tapa cilindros Ø 86.5 ± 1.40	NFT 1 1	450005
0203.240	Junta tapa cilindros Ø 86.5 ± 2.40	NFT	450006
	Jgo. tornillos tapa cilindros (HAS19038)		B450000
0249.140	Conj. junta tapa válvulas (11)	N 1 1	450010
0304.030	Junta para cárter	CG 1	450011
0321.110	Tapa distribución	CG 1	450012
0321.110	Tapa distribución	CG	450112
0322.240	Placa distribución	CB 1	450013
1206.080	Bomba de agua	NB 1 1	450014
0349.030	Jgo. múltiple escape (4)	FCH 1 1	450015
0348.181	Múltiple admisión	NB	450116
0348.181	Múltiple admisión	CB 1 1	450117
1710.070	Salida de escape	FCH 1 1	450018
1710.100	Salida de escape 2B	FCH 1 1	450118
1410.082	Jgo. juntas carburador SOLEX 34 PAIA-2	VS	450120
1405.006	Base carburador	NB 2 2	450125
1406.121	Tapa carburador	CB	450126
1104.040	Bomba aceite a block	CB	450027
1451.031	Base bomba nafta	CB 2	450028
0313.030	Arandela tapón cárter B 18 x 24 x 2.3 CN	CN	450029
	Arandela blindada B 16 x 22 x 2.4 CN	CN	450229
1166.020	Arandela cañería aceite a tapa cilin. A 8 x 14 x 1 C	CU 4 4	450030
1179.040	Tubo llenado aceite	CG 1	450032
0213.030	Arandela capuchón bujías	GS 4 4	450033
0253.050	Tubo separador balancín	GS 2 2	450034
1179.060	Respiradero cárter	CG 1	500234
0127.150	Bastón retén bancada	GS 2	450035
5907.001	Base distribuidor	CB 1	450038
1031.030	Tórica bomba aceite o'ring G 12.42 x 1.78	GS 1	450039
1458.030	Vaso nafta	CG 1	450041
1528.070	Flotante tanque nafta	CG	450042
1451.031	Base bomba nafta	NB	450043
	Avance distribuidor	NB	450044
1912.001	Base filtro nafta	CG	450045
1104.040	Bomba aceite a block	NB 1	450048
2599.160	Jgo. juntas caja velocidades C3B	CB	450050
	Jgo. juntas caja de velocidades BA7	CB	450350
	Tubo empuje sin fin diferencial	CB	450054
3298.030	Jgo. juntas diferencial 67/80	CB	450155
3040.072	Tubo empuje 67/80	CB	450156
4222.060	Palier	CB	450057
	Cierre diferencial ancha 67/80	CB	450159
0304.030	Junta para cárter	CG	450060
	Cierre diferencial angosto 67/80	CB	450162
0112.170	Jgo. suplemento camisas cilindros (4)	GS	450070
	Arandela A 16 x 22 x 1.5 A	AL 1	
	Arandela A 18 x 24 x 1.5 A	AL 1 2	
	Kit de retenes completo		R450000
	Jgo. retén válvulas (8)	T	R450010T
	Jgo. retén válvulas (8)	P 1	R450010P
0517.001	Retén distribución 42 x 60 x 10	P 1	R450012P

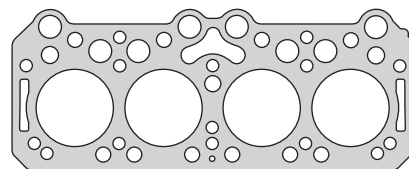

450005

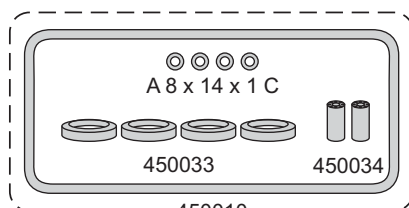

450010

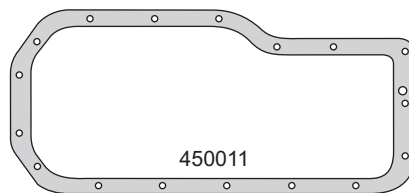

450011

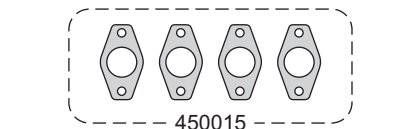

450015

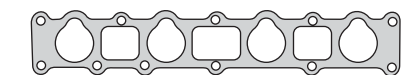

450117

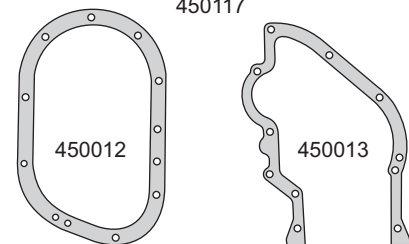

450012

450013

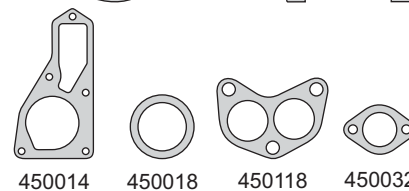

450014

450018

450118

450032

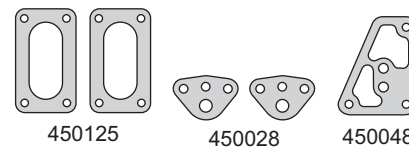

450125

450028

450048

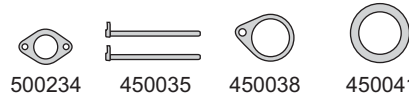

500234

450035

450038

450041



A 16 x 22 x 1.5 A

A 18 x 24 x 1.5 A



G 12.42 x 1.78

R450012P



R450010T



R450010P

PEUGEOT



Motor/Engine	Cm³	HP	Ø
XC7 - XM7	1796	69/79	85

Peugeot: 504 - XE - XL - XSE 1973/78



Nº OE	Descripción/Description	Mat.	Ref.
0199.416	Jgo. de juntas para motor		450200-R
	Jgo. de juntas superior		450295
0203.450	Junta tapa cilindros Ø 86.5 ± 1.40	NFT	1 1 450205
0203.450	Junta tapa cilindros Ø 86.5 ± 2.40	NFT	450206
	Junta tapa cilin. Ø 86.5 ± 1.40 N.R.	NFT	450207
	Jgo. tornillos tapa cilindros (HAS19038)		B450200
0249.140	Conj. junta tapa válvulas (11)	N	1 1 450010
0304.070	Junta para cárter	CG	1 450211
0321.110	Tapa distribución	CG	1 450012
0321.110	Tapa distribución	CG	450112
0322.040	Placa distribución	CB	1 450013
1206.080	Bomba de agua	NB	1 1 450014
0349.030	Jgo. múltiple escape (4)	FCH	1 1 450015
0348.181	Múltiple admisión	NB	450116
0348.181	Múltiple admisión	CB	1 1 450117
1710.100	Salida de escape	FCH	1 1 450118
1410.082	Jgo. juntas carburador SOLEX 34 PAIA-2	VS	450120
1410.072	Jgo. juntas carburador SOLEX C-34 EIES	VS	450220
	Base carburador	NB	1 450025
1405.006	Base carburador	NB	2 2 450125
1406.121	Tapa carburador SOLEX 34 PAIA	CB	450126
1406.122	Tapa carburador SOLEX 34 EIES	CB	450226
1104.040	Bomba aceite a block	CB	450027
1451.031	Base bomba nafta	CB	2 450028
	Arandela tapón cárter B 18 x 24 x 2.3 CN	CN	450029
0164.030	Arandela blindada B 16 x 22 x 2.4 CN	CN	450229
1166.020	Arandela para tapa válvulas A 8 x 14 x 1 C	CU	4 4 450030
1458.030	Tapa bomba nafta	CG	450031
1406.131	Base filtro aire	CB	450231
1179.040	Tubo llenado aceite	CG	1 450032
0213.030	Arandela capuchón bujías	GS	4 4 450033
0253.050	Tubo separador balancines	GS	2 2 450034
1179.060	Respiradero cárter	CG	1 500234
0127.050	Bastón cierre bancada	GS	2 450035
6462.070	Grifo calefactor	NB	450036
1474.030	Cuerpo bomba nafta	CG	450037
5907.001	Base distribuidor	CB	1 450038
1031.030	Tórica bomba aceite o'ring G 12.42 x 1.78	GS	1 450039
1528.070	Flotante tanque nafta	CG	450042
1451.031	Base bomba nafta	NB	450043
	Avance distribuidor	NB	450044
1104.040	Bomba aceite a block	NB	1 450048
3298.030	Jgo. juntas diferencial 67/80	CB	450155
	Tubo empuje 67/80	CB	450156
4222.060	Palier	CB	450057
	Cierre diferencial ancho 67/80	CB	450159
0304.070	Junta para cárter	CGT	450260
	Cierre diferencial angosta 67/80	CB	450162
3298.030	Jgo. suplemento camisa cilindros (0.050) (4)	CU	450270-0.050
0112.590	Jgo. suplemento camisa cilindros (0.075) (4)	CU	450270-0.075
0112.570	Jgo. suplemento camisa cilindros (0.100) (4)	CU	1 450270-0.100
0112.580	Jgo. suplemento camisa cilindros (0.125) (4)	CU	450270-0.125
	Jgo. juntas caja de velocidades BA7	CB	450350

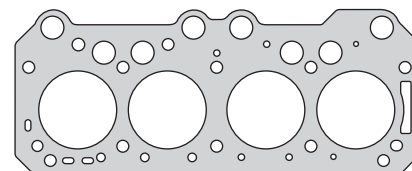

450205

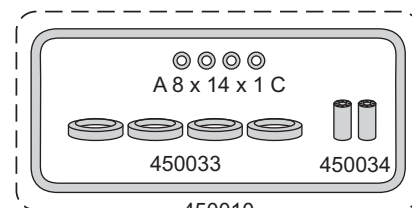

450010

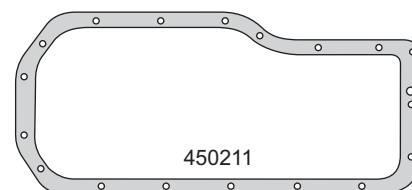

450211

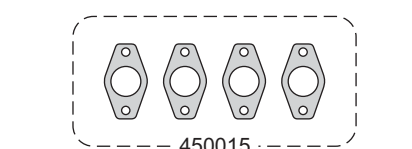

450015

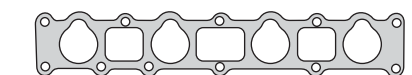

450117

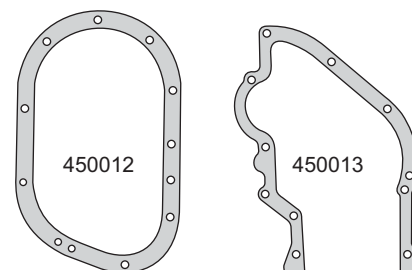

450012

450013

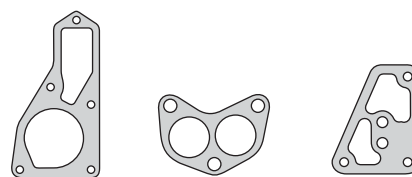

450014

450118

450027

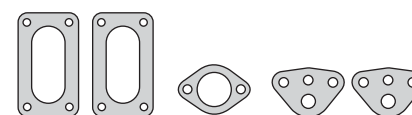

450125

450025

450028

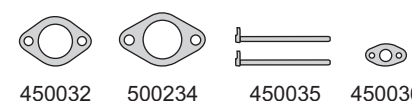

450032

500234

450035

450036



450037

450038

450048

PEUGEOT



Motor/Engine **Cm³** **HP** **Ø**

XN1 -XN2 **1971** **78/85** **88**

Peugeot: 504 - TN - GES - XNA 1976/80



Nº OE	Descripción/Description	Mat.	Ref.
0199.413	Jgo. de juntas para motor		450300-R
0199.418	Jgo. de juntas superior		450395
0203.460	Junta tapa cilindros Ø 90 ± 1.40	NFT 1 1	450305
0203.460	Junta tapa cilindros Ø 90 ± 2.40	NFT	450306
0203.460	Jta. tapa cilindros Ø 90 ± 1.40	NFT	450307
	Jgo. tornillos tapa cilindros (HAS19038)		B450200
	Jgo. de tornillos JTC (HAT55055/HAT55100)		B460200
0249.140	Conj. junta tapa válvulas (11)	N 1 1	450010
0304.070	Junta para cárter	CG 1	450211
0321.110	Tapa distribución	CG 1	450012
0322.040	Placa distribución	CB 1	450013
1206.050	Bomba de agua	NB 1 1	450314
0349.030	Jgo. múltiple escape (4)	FCH 1 1	450015
0348.330	Múltiple admisión	NB 1 1	450317
1710.100	Salida de escape	FCH 1 1	450118
1710.093	Salida de escape TN	FCH	450318
	Cierre termostato	NB	450319
	Termostato	GS	450519
1410.093	Jgo. juntas carburador solex 76/80	VS	450320
	Jgo. juntas carburador solex 33-pbica	VS	450321
1417.500	Jgo. juntas carburador solex 32/35 minsa	VS	450521
	Jgo. juntas carburador solex 34 teie	VS	450322
	Base carburador	NB 2	450225
1406.006	Base carburador	NB 2 2	450325
1406.122	Tapa carburador	CB	450226
	Tapa carburador	CB	450326
1104.040	Bomba aceite a block	CB	450027
1451.031	Base bomba nafta	CB 2	450028
	Arandela tapón cárter B 18 x 24 x 2.3 CN	CN	450029
0164.030	Arandela tapón cárter B 16 x 22 x 2.4 CN	CN	450229
1166.020	Arand. cañería aceite a tapa cilindro A 8 x 14 x 1 C	CU 4 4	450030
1458.030	Tapa bomba nafta	CG	450031
1406.131	Base filtro aire	CB	450231
1179.040	Tubo llenado aceite	CG 1	450032
0213.030	Arandela capuchón bujías	GS 4 4	450033
0253.050	Tubo separador balancines	GS 2 2	450034
1179.060	Respiradero cárter	CG 1	500234
0127.050	Bastón retén bancada	GS 2	450035
6462.070	Grifo calefactor	NB	450036
3015.001	Tubo empuje	NB	450136
1474.030	Cuerpo bomba nafta	CG	450037
5907.001	Base distribuidor	CB 1	450038
1031.030	Tórica bomba de aceite o'ring G 12.42 x 1.78	GS 1	450039
1528.070	Flotante tanque nafta	CG	450042
	Bomba aceite a block	NB 1	450048
	Jgo. junta caja velocidades BA7	CB	450350
	Jgo. juntas diferencial 67/80	CB	450155
3018.001	Tapa diferencial TRANSAX	CG	450355
	Palier TRANSAX	NB	450356
	Cierre diferencial ancha 67/80	CB	450159
0304.070	Junta para cárter	CGT	450260
	Cierre diferencial angosta 67/80	CB	450162
	Tapa diferencial TRANSAX	CGT	450362

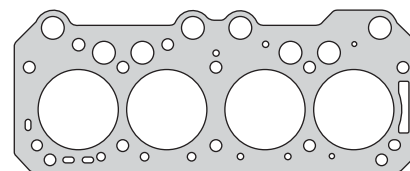

450305

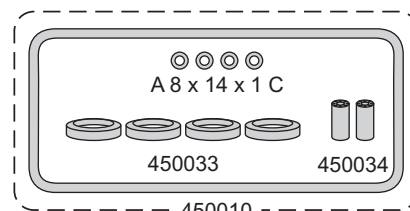

450010

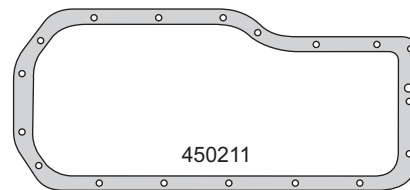

450211

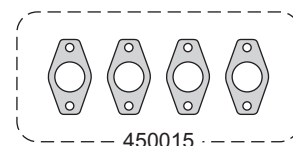

450015

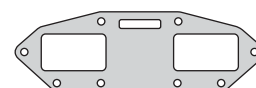

450317

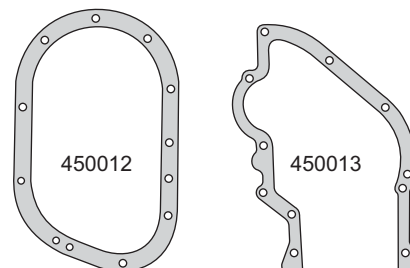

450012

450013

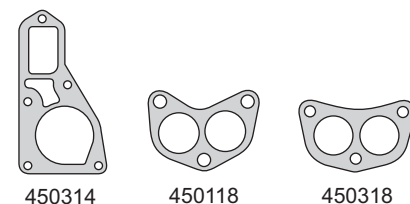

450314

450118

450318

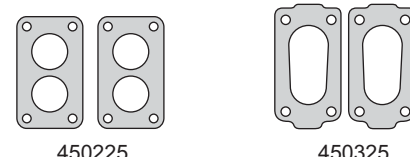

450225

450325

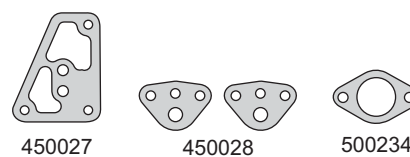

450027

450028

500234

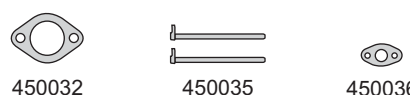

450032

450035

450036

PEUGEOT



Motor/Engine	Cm³	HP	Ø
XN1 -XN2	1971	78/85	88

Peugeot: 504 - TN - GES - XNA 1976/80



Nº OE	Descripción/Description	Mat.	Ref.
3298.030	Jgo. suplemento camisa cilindros (0.050) (4)	CU	450270-0.05
0112.590	Jgo. suplemento camisa cilindros (0.075) (4)	CU	450270-0.075
	Jgo. suplemento camisa cilindros (0.100) (4)	CU	1 450270-0.100
	Jgo. suplemento camisa cilindros (0.125) (4)	CU	450270-0.125
	Arandela A 16 x 22 x 1.5 A	AL	1 1
	Arandela A 18 x 24 x 1.5 A	AL	2
	Kit de retenes completo		R450000
	Jgo. retén válvulas (8)	T	R450010T
	Jgo. retén válvulas (8)	P	1 R450010P
0517.001	Retén distribución 42 x 60 x 10	P	1 R450012P

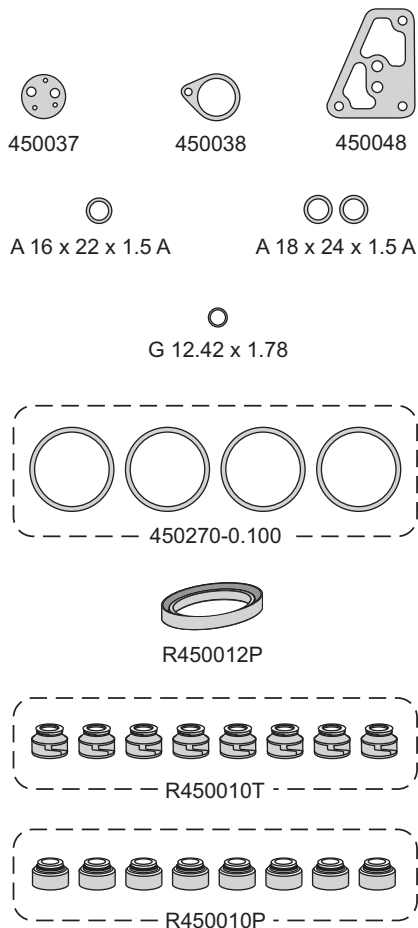

PEUGEOT



Motor/Engine	Cm³	HP	Ø
XD2	2304	70/73	94
XD3	2498	76/90	94
XD3P	2498	76	94

Peugeot: XD2 504/505D - 505/604TD
J7D/J9D
XD3 504/505D - J9

SsangYong: Korando Family 1993/96



DIESEL

Nº OE	Descripción/Description	Mat.	Ref.
	Jgo. de juntas para motor		450700-R-1M
	Jgo. de juntas para motor	●	450700-R-2M
	Jgo. de juntas para motor		450700-R-3M
	Jgo. de juntas para motor		450700-R-4M
	Jgo. de juntas para motor		450701-R
	Jgo. de juntas superior		450795-1M
	Jgo. de juntas superior		450795-2M
	Jgo. de juntas superior		450795-3M
	Jgo. de juntas superior		450795-4M
	Junta tapa cilindros Ø 96 ± 1.50	NFT 1 1	450407-1M
	Junta tapa cilindros Ø 96 ± 1.60	NFT	450407-2M
	Junta tapa cilindros Ø 96 ± 1.70	NFT	450407-3M
	Junta tapa cilindros Ø 96 ± 1.80	NFT	450407-4M
	Junta tapa cilindros Ø 96 ± 1.60	NFT	450409-2M
	Junta tapa cilindros Ø 96 ± 1.70	NFT	450409-3M
	Junta tapa cilindros Ø 96 ± 1.80	NFT	450409-4M
	Jgo. tornillos tapa cilindros (HAS17038)		B450700
	Jgo. tornillos tapa cilindros (HAS12038)		B450700-1
0249.250	Conj. junta tapa válvulas superior (11)	CG 1 1	500210
0313.190	Junta para cárter	NB 1	450411
0321.390	Tapa distribución	CB 1	450412
0322.081	Contratapa distribución 88/...	CB 1	450413
0322.220	Contratapa distribución 88/...	CB 1	450713
1206.230	Bomba de agua	NB 1 1	450414
	Tapa bomba de agua con prolongación	NB 1 1	450714
0349.080	Múltiple escape XD2	FCH 2 2	500215
	Múltiple escape XD3	NFT 2 2	450416
0349.540	Múltiple escape	NFT 2 2	450716
	Múltiple admisión	NB 2 2	500217
1710.200	Salida de escape T4B	FCH 1 1	450418
1720.270	Salida de escape XD3	NFT 1 1	450718
1104.130	Base filtro aceite	NB 1	500227
1927.070	Base bomba inyectora	CB 1	450427
	Arandela tapón cárter B 18 x 24 x 2.3 CN	CN	450029
0243.010	Arandela blindada B 16 x 21 x 2.2 CN	CN 3	450229
0253.031	Arandela tapa válvulas XD2 A 8 x 20 x 1.4	NB 4 4	500230
	Arandela tapa válvulas XD3 A 7 x 17 x 1.4	NB 4 4	550430
0147.100	Tapa botadores	NB 2	450431
	Múltiple admisión central	NB 1 1	500235
0127.050	Bastón bancada	GS 2	450435
1710.430	Múltiple escape a codo	FCH 1 1	450735
1981.020	Arandela parallamas pico inyector	AC 4 4	560036
	Jgo. admisión y escape XD2 (5)	VS 1 1	500236
	Jgo. admisión y escape XD3 (5)	VS 1 1	450736
1925.120	O´ring tapa bomba inyectora	GS	450737
0321.390	Tapa distribución	NB	450438
0322.081	Placa distribución XD2	NB	450439
0322.220	Placa distribución XD3	NB	450739
1981.050	Arandela base inyector A 16 x 21 x 2 C	CU 4 4	500240
	O´ring inyector	GS	450440
0249.050	Arandela conduc. flauta balancines G 16 x 7 x 5	GS 1 1	500241
0133.966	Anillo termostato	GS 1 1	550641
1041.100	Bomba aceite a block	NB 1	500242

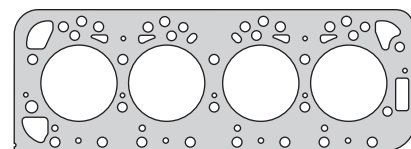

450407

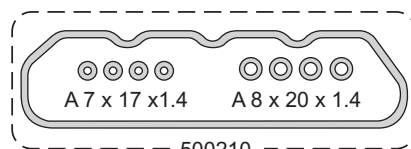

500210

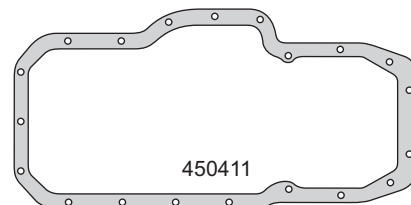

450411

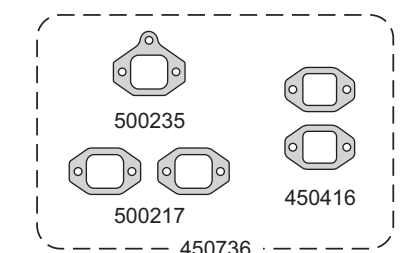

500235

500217

450416

450736

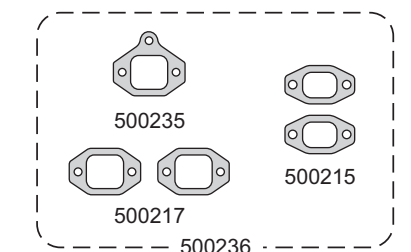

500235

500217

500215

500236

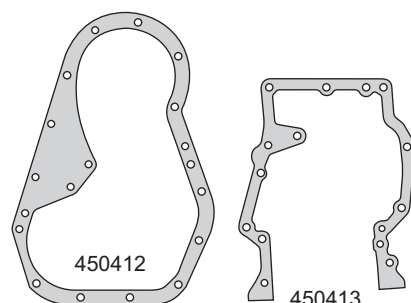

450412

450413

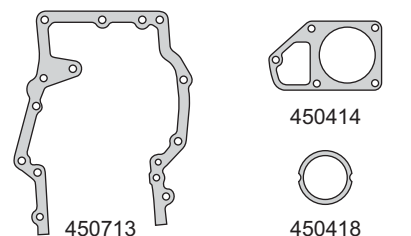

450713

450418

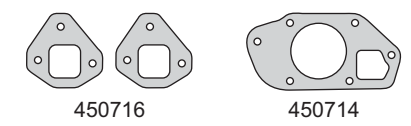

450716

450714

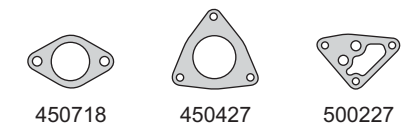

450718

450427

500227

PEUGEOT



Motor/Engine	Cm³	HP	Ø
XD2	2304	70/73	94
XD3	2498	76/90	94
XD3P	2498	76	94

Peugeot: XD2 504/505D - 505/604TD
J7D/J9D
XD3 504/505D - J9
SsangYong: Korando Family 1993/96



DIESEL

Nº OE	Descripción/Description	Mat.	Ref.
	Jgo. múltiple escape 505 / 92 XD3	NFT	450742
0236.070	Tapa cámara agua	NB 2 2	500243
	Escape turbo - E/PRIS Ø66	NB	560543
0956.010	Retén guía válvulas G 14 x 7 x 3	GS 8	500245
	Regulación bomba inyectora	NB 1	500246
	Escape turbo - E/ PRIS. Ø 63 mm.	AC	500546
1562.210	Arandela cañería gasoil A 12 x 16 x 1.5 C	CU 8 8	500251
1166.020	Arandela conexión presión aceite A 8 x 13 x 1 C	CU 6	500252
1562.490	Arandela ret. reb. inyectora A 8 x 12 x 1 C	CU 8 8	500253
0157.080	Arandela tapón desagote agua A 14 x 20 x 1.5 C	CU 1	500254
0119.120	Jgo. juntas empaquetadura bancada (2)	SNA 1	450758
0249.250	Tapa válvulas superior	CGT	500261
0119.180	Jgo. suplemento camisa cilindros (4)	GS	500270
0119.180	Jgo. suplemento camisa cilindros (4)	S	500271
	O'ring G 101.32 x 1.78	GS 1	
	Kit de retenes completo (polea angosta)		R450400
	Kit de retenes completo (hasta 4/86)		R450400-1
	Kit ret. compl. (desde 5/86 polea ancha)		R450400-2
	Jgo. retén válvulas (8)	V 1	R460210V
	Retén bancada (reforma expansible)	S	R450411-1S
0517.001	Ret. dist. 45 x 60 x 10 Ø45 (polea angosta)	S	R450412S
048.410	Ret. dist. 42 x 60 x 8 Ø42 (hasta 4/86)	P 1	R450412-1P
048.410	Ret. dist. 45 x 60 x 7 Ø45 (desde 5/86)	P 1	R450412-2P

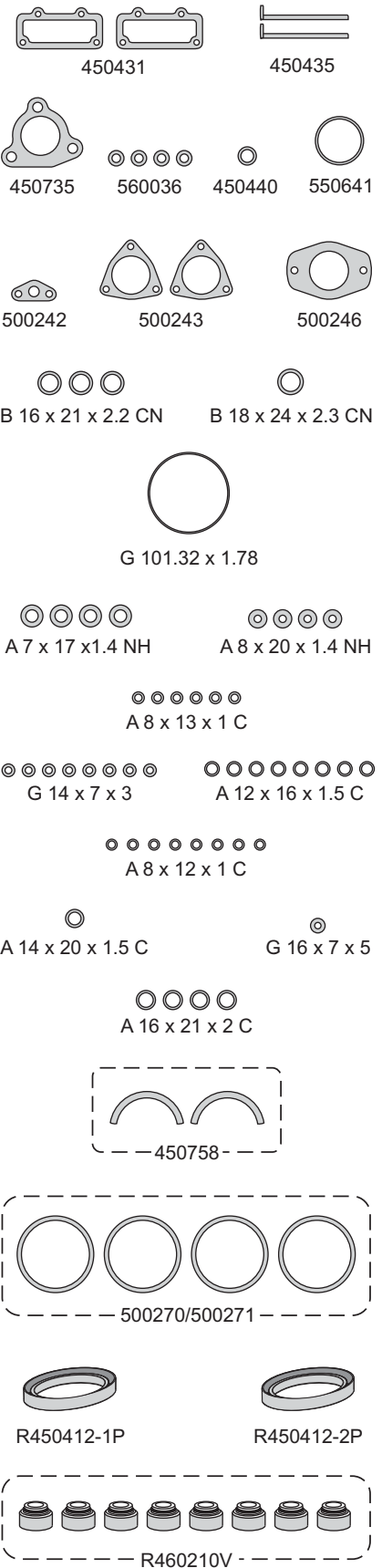

PEUGEOT



Motor/Engine	Cm³	HP	Ø
GR/SR XN1/XN2	1971	85	88

Peugeot: 505 - 9R - J9/J5 1980/92



Nº OE	Descripción/Description	Mat.	Ref.
0199.424	Jgo. de juntas para motor		450500-R
0203.460	Junta tapa cilindros Ø 90 \pm 1.40	NFT	1 450305
0203.460	Junta tapa cilindros Ø 90 \pm 2.40	NFT	450306
0203.460	Junta tapa cilindros Ø 90 \pm 1.40	NFT	450307
	Jgo. tornillos tapa cilindros (HAS19038)		B450200
	Jgo. tornillos tapa cilin. (HAT55055/HAT55100)		B460200
0249.140	Conj. junta tapa válvulas (11)	N	1 450010
0304.070	Junta para cárter	CG	450211
0321.110	Tapa distribución	CG	1 450012
0321.110	Tapa distribución	CGT	450112
0332.040	Placa distribución	CB	1 450013
1206.050	Bomba de agua	NB	1 450314
	Bomba de agua	NB	450514
0349.030	Jgo. múltiple escape (4)	FCH	1 450015
0348.330	Múltiple admisión	NB	1 450317
1710.100	Salida de escape	FCH	450118
1710.240	Salida de escape	FCH	1 450518
	Guarnición termostato	GS	450519
	Jgo. juntas carburador SOLEX C34 EIES/7	VS	450520
	Jgo. juntas carburador SOLEX 32/35 MINSÁ	VS	450521
	Jgo. juntas carburador SOLEX 34/34-ZI	VS	450522
	Jgo. juntas carburador SOLEX 32/35-T MIMA	VS	450523
1406.006	Base carburador 34 EIES'82	NB	450125
1406.006	Base carburador C34 EIES 83/	NB	2 450325
	Base carburador MINSÁ	NB	2 450525
1406.122	Tapa carburador 34 EIES 82	CB	450226
	Tapa carburador MINSÁ	CB	450526
1104.040	Bomba aceite a block	CB	450027
1451.031	Base bomba nafta	CB	2 450028
0164.030	Arandela tapón cárter B 16 x 22 x 2.4 CN	CN	450229
1166.020	Arandela cañería ac.a tapa cilindro A 8 x 14 x 1C	CU	4 450030
1458.030	Tapa bomba nafta	CG	450031
0301.360	Junta para cárter chico con aire	CG	1 450531
1179.040	Tubo llenado aceite	CG	1 450032
0213.030	Arandela capuchón bujías	GS	4 450033
0253.050	Tubo separador balancines	GS	2 450034
1179.060	Respiradero cárter	CG	1 500234
0127.050	Bastón retén bancada	GS	2 450035
1031.030	Base distribuidor	CB	1 450038
0304.070	Junta para cárter	NB	1 450538
1031.030	Tórica bomba aceite o'ring G 12.42 x 1.78	GS	1 450039
	Base carburador 34-34-Z1	NB	450540
0301.360	Cárter chico (Accopac)	CB	450541
1451.031	Base bomba nafta	NB	450543
031.360	Junta para cárter chico	NB	450545
0301.360	Junta para cárter chico	CGT	450546
1104.040	Bomba aceite a block	NB	1 450048
	Jgo. juntas caja velocidades BA7	CB	450350
3018.001	Tapa diferencial TRANSAX	CG	450355
	Jgo. juntas diferencial hipoidal	CB	450555
	Palier TRANSAX	NB	450356
	Tubo empuje	CB	450556
0304.070	Junta para cárter	CGT	450260

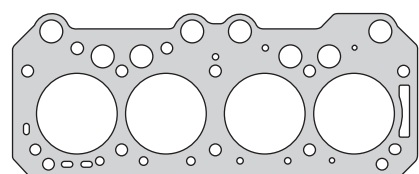

450305

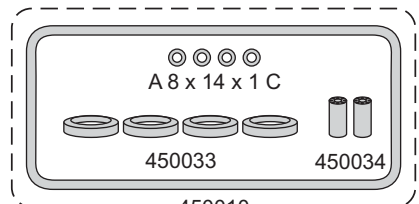

A 8 x 14 x 1 C

450033

450034

450010

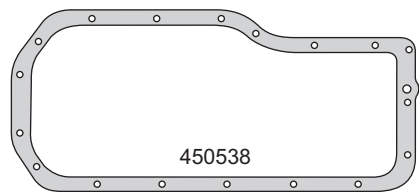

450538

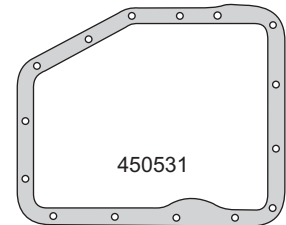

450531

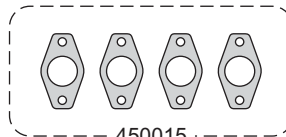

450015

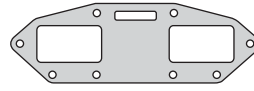

450317

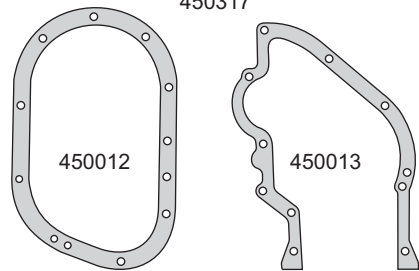

450012

450013

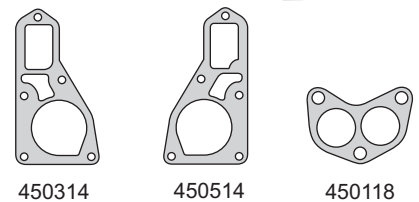

450314

450514

450118

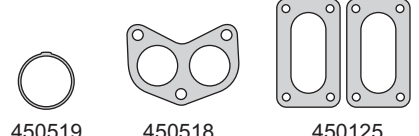

450519

450518

450125

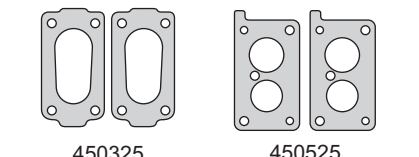

450325

450525

PEUGEOT



Motor/Engine	Cm ³	HP	Ø
GR/SR XN1/XN2	1971	85	88

Peugeot: 505 - 9R - J9/J5 1980/92



N° OE	Descripción/Description	Mat.	Ref.
	Tapa diferencial TRANSAX	CGT	450362
3292.030	Jgo. suplemento camisa cilindros (0.050) (4)	CU	450270-0.05
0112.590	Jgo. suplemento camisa cilindros (0.075) (4)	CU	450270-0.075
0112.570	Jgo. suplemento camisa cilindros (0.100) (4)	CU 1	450270-0.100
0112.580	Jgo. suplemento camisa cilindros (0.125) (4)	CU	450270-0.125
	Arandela A 16 x 22 x 1.5 A	AL	1
	Kit de retenes completo		R450000
	Jgo. retén válvulas (8)	T	R450010T
	Jgo. retén válvulas (8)	P	1 R450010P
0517.001	Retén distribución 42 x 60 x 10	P	1 R450012P

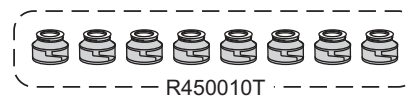
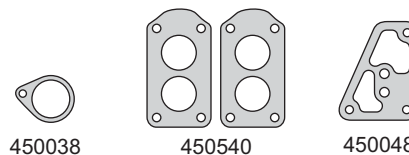

PEUGEOT



Motor/Engine	Cm³	HP	Ø
XN2 - XN6	1971	105	88

Peugeot: 505 1983/86 - 504 1970/84
604 1982/86



Nº OE	Descripción/Description	Mat.	Ref.
	Jgo. de juntas para motor		450600-R
	Junta tapa cilindros Ø 90 \pm 1.50	NFT	450507-1.50
	Junta tapa cilindros Ø 90 \pm 1.80	NFT	450507-1.80
	Jgo. tornillos tapa cilindros (HAS19038)		B450200
0249.140	Conj. junta tapa válvulas (11)	N	450010
0304.070	Junta para cárter	CG	450211
0321.110	Tapa distribución	CG	450012
0321.110	Tapa distribución	CG	450112
0322.040	Placa distribución	CB	450013
1206.050	Bomba de agua	NB	450314
	Bomba de agua	NB	450514
0349.030	Jgo. múltiple escape (4)	FCH	450015
	Múltiple admisión	NB	450517
1710.240	Salida de escape	FCH	450518
	Termostato	GS	450519
1104.040	Bomba aceite a block	CB	450027
0164.030	Arandela tapón cárter B 16 x 22 x 2.4 CN	CN	450229
1166.020	Arandela cañería ac. a tapa cilindros A 8 x 14 x 1 C	CU	450030
0301.360	Cárter chico	CG	450531
1179.040	Tubo llenado aceite	CG	450032
0213.030	Arandela capuchón bujías	GS	450033
0253.050	Tubo separador balancines	GS	450034
0127.050	Bastón retén bancadas	GS	450035
5907.001	Base distribuidor	CB	450038
0304.070	Junta para cárter	NB	450538
1031.030	Tórica bomba aceite o'ring G 12.42 x 1.78	GS	450039
0301.360	Junta para cárter chico (Accopac)	CB	450541
0301.360	Junta para cárter chico	NB	450545
0301.360	Junta para cárter chico	CG	450546
1104.040	Bomba aceite a block	NB	450048
	Jgo. juntas caja velocidades BA7	CB	450350
	Jgo. juntas diferencial Hipoidal	CB	450555
	Palier TRANSAX	NB	450356
	Tubo empuje	CB	450556
3040.070	Cierre diferencial	CB	450159
0304.070	Junta para cárter	CGT	450260
	Tapa diferencial TRANSAX	CGT	450362
3298.030	Jgo. suplemento camisa cilindros (0.050) (4)	CU	450270-0.05
0112.590	Jgo. suplemento camisa cilindros (0.075) (4)	CU	450270-0.075
0112.570	Jgo. suplemento camisa cilindros (0.100) (4)	CU	450270-0.100
0112.580	Jgo. suplemento camisa cilindros (1.125) (4)	CU	450270-0.125
	Arandela A 16 x 22 x 1.5 A	AL	1
	Kit de retenes completo		R450000
	Jgo. retén válvulas (8)	P	1 R450010P
	Jgo. retén válvulas (8)	T	R450010T
0517.001	Retén distribución 42 x 60 x 10	P	1 R450012P

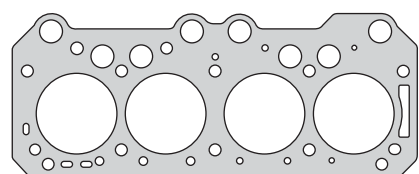

450507 - 1.80

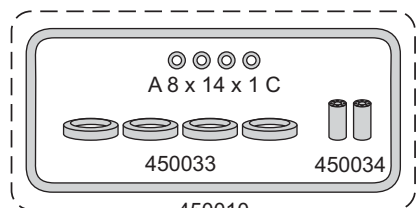

450010

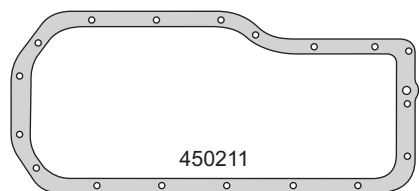

450211

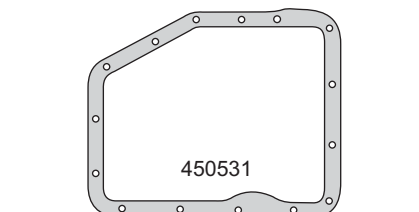

450531

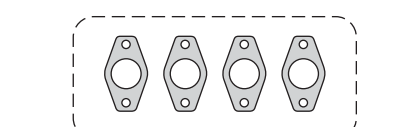

450015



450517

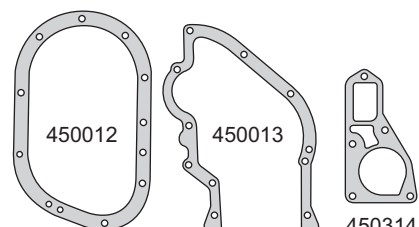

450012

450013

450314

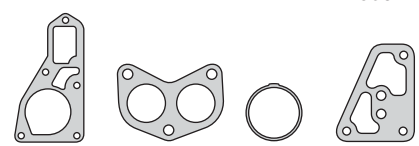

450514 450518 450519 450048

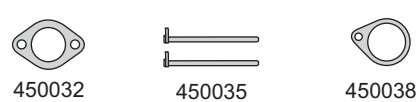

450032 450035 450038



A 16 x 22 x 1.5 A G 12.42 x 1.78



R450012P



R450010T



R450010P

PEUGEOT



Motor/Engine	Cm³	HP	Ø
XN1 - XNA Gamma	1971	90	88

Peugeot: 505 1987/...



Nº OE	Descripción/Description	Mat.	Ref.
	Jgo. de juntas para motor		450800-R
0321.110	Junta tapa cilindros Ø 90 \pm 1.50	NFT	450507-1.50
	Junta tapa cilindros Ø 90 \pm 1.80	NFT	1 450507-1.80
	Jgo. tornillos tapa cilindros (HAS19038)		B450200
0321.110	Jgo. tornillos tapa cilin. (HAT55055/HAT55100)		B460200
	Conj. junta tapa válvulas	N	1 450010
0249.140	Junta para cárter	CG	450211
0304.070	Tapa distribución	CG	1 450012
0321.110	Tapa distribución	CGT	450112
0321.110	Placa distribución	CB	1 450013
0322.040	Bomba de agua	NB	1 450314
1206.050	Bomba de agua	NB	450514
	Jgo. múltiple escape (4)	FCH	1 450015
0349.030	Múltiple admisión	NB	1 450317
0348.330	Salida de escape	FCH	1 450518
1710.240	Termostato	GS	450519
	Jgo. juntas carburador SOLEX C34 EIES/7	VS	450520
	Jgo. juntas carburador SOLEX 32/35 MINSÁ	VS	450521
	Jgo. juntas carburador SOLEX 34/34 ZI	VS	450522
	Base carburador 34 EIES '82	NB	450125
1406.006	Base carburador C34 EIES 83/	NB	2 450325
1406.006	Base carburador MINSÁ	NB	2 450525
	Tapa carburador 34 EIES '82	CB	450226
1406.122	Tapa carburador MINSÁ	CB	450526
	Bomba aceite a block	CB	450027
1104.040	Base bomba nafta	CB	2 450028
1451.031	Arandela tapón cárter B 16 x 22 x 2.4 CN	CN	450229
0164.030	Arandela cañería aceite a tapa cilindros A 8 x 14 x 1 C	CU	4 450030
1166.020	Tapa bomba nafta	CG	450031
1458.030	Junta para cárter chico con aire	CG	1 450531
0301.360	Tubo llenado de aceite	CG	1 450032
1179.040	Arandela capuchón bujías	GS	4 450033
0213.030	Tubo separador balancines	GS	2 450034
0253.050	Respiradero cárter	CG	1 500234
1179.060	Bastón retén bancada	GS	2 450035
0127.050	Grifo calefactor	NB	450036
6462.070	Base distribuidor	CB	1 450038
1474.030	Junta para cárter	NB	1 450538
0304.070	Tórica bomba de aceite G 12.42 x 1.78	GS	1 450039
1031.030	Base carburador 34-34 ZI	NB	450540
0301.360	Cárter chico (Accopac)	CB	450541
1451.031	Tapa carburador 34-34 ZI	NB	450043
0301.360	Junta para cárter chico con aire	NB	450545
0301.36	Junta para cárter chico con aire	CGT	450546
1104.040	Bomba aceite a block	NB	450048
3018.001	Tapa diferencial TRANSAX	CG	450355
	Jgo. juntas diferencial hipoidal	CB	450555
	Palier TRANSAX	NB	450356
	Tubo empuje	CB	450556
0304.070	Junta para cárter	CGT	450260
	Tapa diferencial	CGT	450362
3298.030	Jgo. suplemento camisa cilindros (0.050) (4)	CU	450270-0.05
0112.590	Jgo. suplemento camisa cilindros (0.075) (4)	CU	450270-0.075

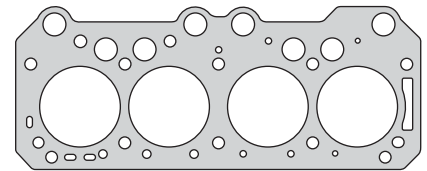

450507 - 1.80

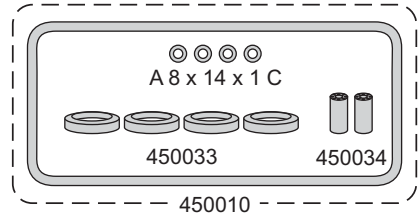

450010

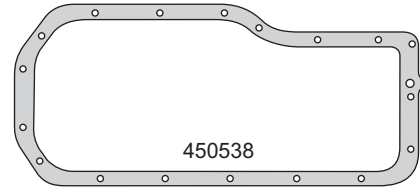

450538

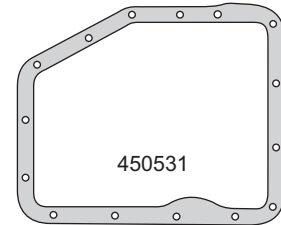

450531

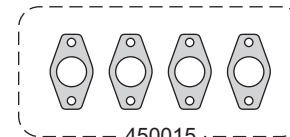

450015

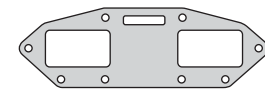

450317

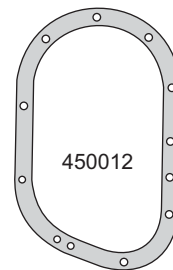

450012

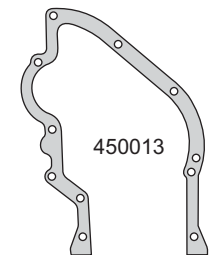

450013



450314



450514



450519



450518

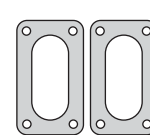

450125

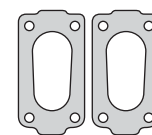

450325

PEUGEOT



Motor/Engine	Cm³	HP	Ø
7CV	1290	52	75
8CV	1468	55/58	80

Peugeot: 403/7 1959/66
403/8 1955/67



Nº OE	Descripción/Description	Mat.	Ref.
0199.130	Jgo. de juntas para motor		450900-R
0203.180	Junta tapa cilindros Ø 82 \pm 1.40	NFT	1 450905
0203.180	Junta tapa cilindros Ø 82 \pm 2.40	NFT	450906
0249.090	Conj. junta tapa válvulas superior (11)	GS	1 450910
	Jgo. junta para cárter (4)	CG	1 450911
0321.050	Tapa distribución	CG	1 450912
0321.060	Placa distribución	CB	1 450913
1206.050	Bomba de agua	NB	1 450914
0349.030	Jgo. múltiple escape (4)	FCH	1 450015
0236.010	Múltiple admisión	CB	1 450917
1710.040	Salida de escape	FCH	1 450918
1410.070	Jgo. juntas carburador	VS	450020
1406.340	Base carburador	NB	1 450025
1406.120	Tapa carburador	CB	450026
1451.131	Base bomba nafta	CB	2 450028
0313.030	Arandela tapón cárter B18 x 24 x 2.3 CN	CN	450029
1166.020	Arandela tapa válvulas A 8 x 14 x 1 C	CU	4 450030
0313.030	Junta para cárter chico	CG	1 450931
0110.401	Filtro aceite a block	CB	1 450932
0213.030	Arandela capuchón bujías	GS	4 450033
0110.401	Filtro aceite a block		450933
0253.050	Tubo separador balancines	GS	2 450034
0111.502	Tapa filtro aceite	CB	1 450934
0127.050	Bastón retén bancada	GS	2 450035
5907.001	Base distribuidor	CB	1 450038
1912.001	Vaso nafta	CG	1 450041
1451.031	Base bomba nafta	NB	450043
	Arandela A 18 x 24 x 1.5 A	AL	1
	Kit de retenes completo		R450000
	Jgo. reten válvulas	P	1 R450010P
	Jgo. retén válvulas (8)	T	R450010T
0517.001	Retén distribución 42 x 60 x 10	P	1 R450012P

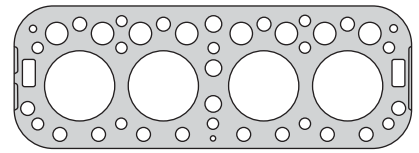

450905

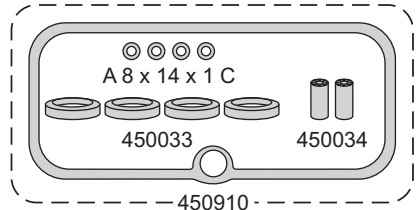

450910

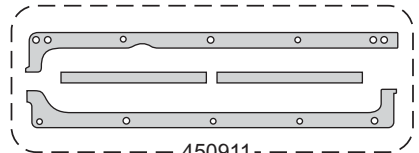

450911

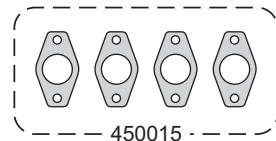

450015



450917

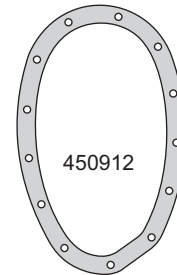

450912

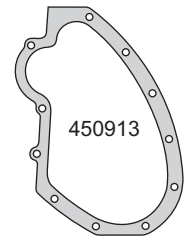

450913

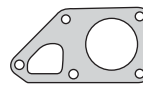

450914



450918

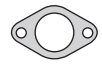

450025

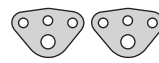

450028



450034



450035



450932

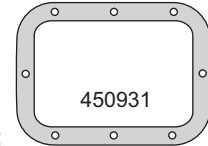

450931



450038



450041



A 18 x 24 x 1.5 A



450934



R450012P



R450010T



R450010P

PEUGEOT



Motor/Engine	Cm³	HP	Ø
XU5CP - XU5J	1580	75/105	83
XU5JA - XU5M	1580	90/115	83
XU5S/1C/CP	1580	75/80	83
XU92S - XU9J1	1905	96/104	83
XU9J1/J2/JA/M	1905	102/125	83
XU92C-XU9JAZ	1905	109/125	83

Citroën: BX16 1985/90 - BX 16 GTI 1991/93
 Visa GTI - BX 19 - BX 19 GTI 1984/93
Peugeot: 305 1982/91 - 205 1984/96
 309 1985/93 - 405 1987/95
 205 1986/94

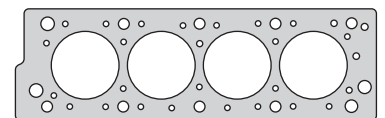

460207-1.20



460210/1

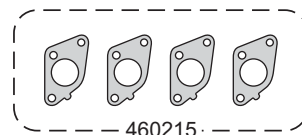

460215



460217



460219

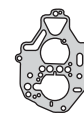

460226



460233



460227



460228











A6 x 11 x 2 C



R460213V



R450010P

Nº OE	Descripción/Description	Mat.	Ref.
	Jgo. de juntas superior		451295-R
	Junta tapa cilindros Ø 84 \pm 1.20 	NFT 1	460207-1.20
	Jgo. tornillos tapa cilin. (HAT55055/HAT55100) 		B460200
	Sellador líquido - caucho de silicona 		TRN0280R
0249.480	Junta tapa válvulas 	N 1	460210/1
0349.700	Jgo. múltiple escape (4) 	NFT 1	460215
0348.910	Múltiple admisión inyección 	NB 1	460217
1339.530	Termostato	GS 2	460219
	Tapa carburador	CB 1	460226
	Junta brida	NFT 1	460227
1451.070	Bomba nafta	NB 2	460228
1339.410	Alojamiento termostato	NB 1	460233
	Arandela tubería aceite A 6 x 11 x 2 C	CU 3	460239
	Jgo. retén válvulas (8) 	P 1	R450010P
0236.44	Retén árbol levas 36 x 50 x 8 	V 1	R460213V

PEUGEOT



Motor/Engine	Cm³	HP	Ø
XU10M	1998	107	86
XU102C	1998	115	86
XU10J2	1998	122/130	86

Citroën: XM 1989/94 - 1990/93
Peugeot: 605 1989/98



Nº OE	Descripción/Description	Mat.	Ref.
	Jgo. de juntas superior		451395-R
0209.N1	Junta tapa cilindros Ø 87 ± 1.20	NFT 1	451307
0204.65	Jgo. tornillos tapa cilin. (HAT55055/HAT55100)		B460300
	Sellador líquido - caucho de silicona		TRN0280R
0249.480	Junta tapa válvulas	N 1	460210/1
0349.700	Jgo. múltiple escape (4)	FCH 1	460215
0348.ED	Múltiple admisión	NH 1	451317
1339.530	Termostato	GS 2	460219
	Tapa carburador	CB 1	460226
	Guarnición	GS 1	451330
	Guarnición	GS 1	451331
1339.410	Junta alojamiento termostato	NB 1	460233
	Arandela A 6 x 10 x 1 C	CU 13	
	O´ring G 36.17 x 2.62	GS 1	
0956.22	Jgo. retén válvulas (8)	P 1	R450010P
0127.28	Retén bancada 90 x 110 x 7	V	R460211V
0326.12	Retén distribución 42 x 62 x 7	V	R460212V
0236.44	Retén árbol levas 36 x 50 x 8	V 1	R460213V

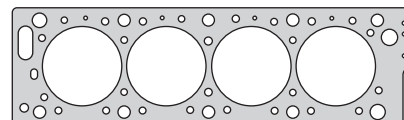

451307



460210/1

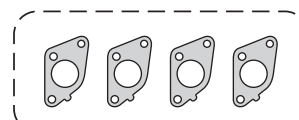

460215

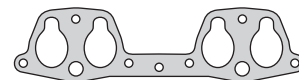

451317



460226



460219



460233



451330



451331



A 6 x 10 x 1 C



G 36.17 x 2.62

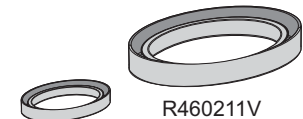

R460212V

R460211V

R460213V



R450010P

PEUGEOT



Motor/Engine	Cm³	HP	Ø
TU9/K/MZ/M	954	45/50	70
TU1M	1124	54/60	72

Citroën: C15 1988/... - AX 10 1986/...
Saxo - ZX - Berlingo 1996/...
Peugeot: 106 - 306 - Partner 1996/...
205 1987/93 - 106 1991/...



Nº OE	Descripción/Description	Mat.	Ref.
	Jgo. de juntas para motor		451500-R
	Jgo. de juntas superior	●	451595
	Jta. tapa cilindros Ø 73.5 ± 1.30 N.R.	NFT 1 1	451507
	Jgo. tornillos tapa cilindros (HAE14038)		B470500
	Conj. junta tapa válvulas (3)	GS 1 1	460710
	Junta para cárter	NB 1 1	460711
	Jgo. múltiple escape (2)	NFT 1 1	460416
	Jgo. múltiple admisión (2)	NB 1 1	460717
	Salida de escape	NFT 1 1	451518
	Junta bomba combustible	NB 2 2	451528
	Junta brida	CB 1 1	451530
	Junta asiento carburador	NB 1 1	460730
	Arandela tapa válvulas	GS 2 2	451732
	Guarnición termostato	GS 1 1	460245
	Arandela A 12 x 18 x 1 C	CU 1 1	
	Arandela A 20 x 26 x 2 F	F 1 1	
	Arandela A 8 x 20 x 1.5 F	NB 3 3	
	Arandela A 16 x 22 x 1.5 A	AL 1 1	
	O´ring G 36 x 3	GS 1 1	
	O´ring G 52.07 x 2.62	GS	1
	O´ring G 79.5 x 3	GS 1 1	
	Kit de retenes completo		R470400
	Jgo. retén válvulas (8)	V 1	R460710V
	Retén bancada 85 x 105 x 12	V 1	R220411V
	Retén distribución 42 x 66 x 8	V 1	R460712V
0236.44	Retén árbol levas 36 x 50 x 8	V 1	R460213V

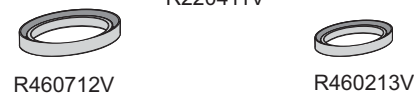
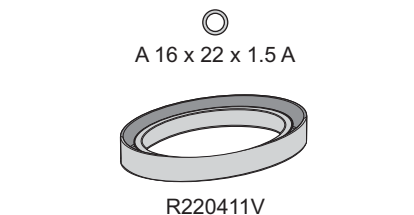
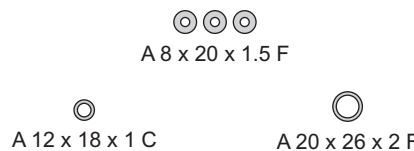
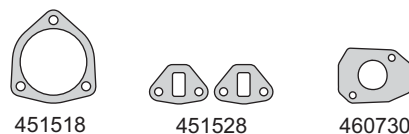
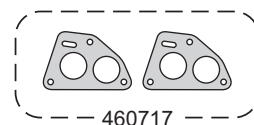
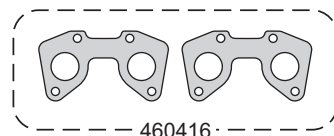
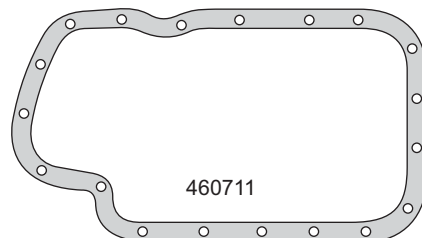
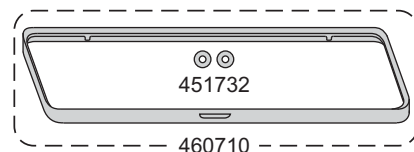
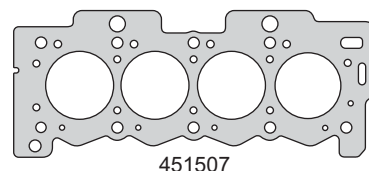

PEUGEOT



Motor/Engine	Cm³	HP	Ø
TU3F/FM	1360	75/80	75
TU3F2/F2C	1360	75/80	75
TU3J2/Z	1360	75/94	75

(Motor con block de fundición gris)

Citroën: AX14 - BX14 1991/... - ZX 1994/...
AXGT 1993/... C15 1991/...

Peugeot: 106 1994/96 - 309 1992/93
405 1993/94 - 205 1991/93



Nº OE	Descripción/Description	Mat.	Ref.
	Jgo. de juntas para motor		451600-R
	Junta tapa cilindros Ø 76 ± 1.30	NFT 1	451607
	Jgo. tornillos tapa cilindros (HAE14038)		B470500
	Conj. junta tapa válvulas (3)	GS 1	460710
	Junta para cárter	NB 1	451611
	Jgo. múltiple escape (2)	AC 1	451615
	Jgo. múltiple admisión (4)	GS 1	451617
	Salido de escape	NFT 1	460718
	Jta. cuello bomba de agua	NB 1	451619
	Arandela tapa válvulas	GS 2	451732
	Guarnición termostato	GS 1	460245
	Junta base carburador	NB 2	06053
	O´ring G 36.17 x 2.62	GS 1	
	O´ring G 75.87 x 2.62	GS 1	
	Arandela A 12 x 18 x 1.5 A	AL 1	
	Arandela A 22 x 30 x 2 C	CU 3	
	Arandela A 17 x 22 x 1.5 C	CU 2	
	Arandela A 8 x 20 x 1.5	NB	
	Kit de retenes completo	1	R470500
	Jgo. retén válvulas (8)	V 1	R460710V
0514.74	Retén bancada 85 x 105 x 8	V 1	R560111V
0514.72	Retén distribución 42 x 66 x 8	V 1	R460712V
0236.44	Retén árbol de levas 36 x 50 x 8	V 2	R460213V

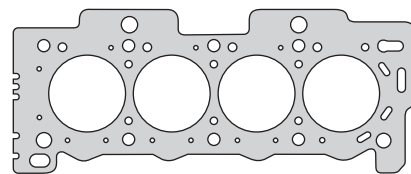

451607

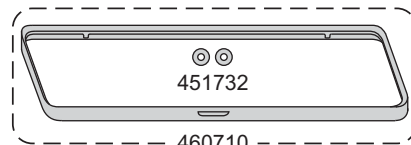

451732

460710

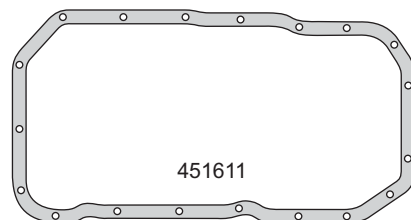

451611

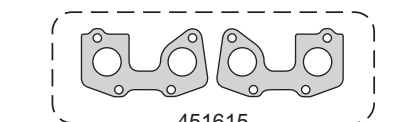

451615



451617



460718

451619

06053



G 36.17 x 2.62

460245

G 75.87 x 2.62



A 17 x 22 x 1.5 C

A 12 x 18 x 1.5 A



A 22 x 30 x 2 C

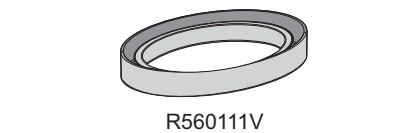

R560111V



R460712V

R460213V

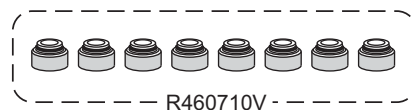

R460710V

PEUGEOT



Motor/Engine	Cm³	HP	Ø
TU1/K/Z/M/MZ	1124	55/60	72
TU3M/MC/A/JP	1360	70/75	75
TU3S/M (Motor con block de aluminio)	1360	80/85	75

Citroën: BX 11 - C15 1988/... - Saxo 1996/...
 AX 14 - AX GT 1986/... - ZX 1991/98
 Berlingo - Xsara 1996/...

Peugeot: 106 1991/... - 306 1993/... - 405 1987/94
 205 1987/96, 1998/... - 309 1988/93
 Partner 1996/...



Nº OE	Descripción/Description	Mat.	Ref.
	Jgo. de juntas para motor		451700-R
	Jgo. de juntas superior		451795
	Jta. tapa cilindros Ø 76 ± 1.30	NFT 1 1	451707
	Jgo. tornillos tapa cilindros (HAE14038)		B470500
	Sellador líquido - caucho de silicona		TRN0280R
	Conj. junta tapa válvulas (3)	GS 1 1	460710
	Junta para cárter	NB 1 1	460711
	Jgo. múltiple escape (2)	NFT 1 1	460416
	Jgo. múltiple admisión (2)	NB 1 1	460717
	Salida de escape	NFT 1 1	451518
	Junta bomba combustible	NB 2 2	451528
	Junta brida	CB 1 1	451530
	Junta	CB 1 1	451730
	Junta asiento carburador	NB 1 1	460730
	Junta	CB 1 1	451731
	Arandela tapa válvulas	GS 2 2	451732
	Guarnición termostato	GS 1 1	460245
	Jgo. suplemento camisa cilindros (4)	S 1	550671
	Arandela A 12 x 18 x 1 C	CU 1 1	
	Arandela A 20 x 26 x 2 F	F 1 1	
	Arandela A 16 x 24 x 1 C	CU 1	
	Arandela A 22 x 30 x 2 C	CU 2	
	Arandela A 22 x 28 x 2 A	AL 2	
	Arandela A 16 x 22 x 1.5 A	AL 1 2	
	O´ring G 36 x 3	GS 1 2	
	O´ring G 79.5 x 3	GS 1 1	
	O´ring G 56.82 x 2.62	GS 1	
	O´ring G 72.62 x 3.53	GS 1	
	Kit de retenes completo		R470400
	Jgo. retén válvulas (8)	V 1 1	R460710V
0514.74	Retén bancada 85 x 105 x 12	V 1	R220411V
0514.72	Retén distribución 42 x 66 x 8	V 1	R460712V
0236.44	Retén árbol levas 36 x 50 x 8	V 1	R460213V

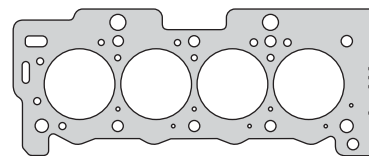

451707

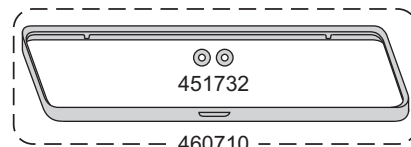

451732

460710

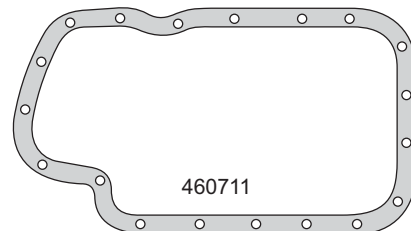

460711

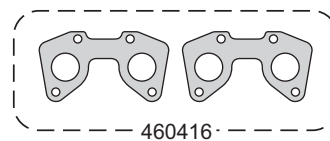

460416

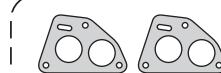

460717

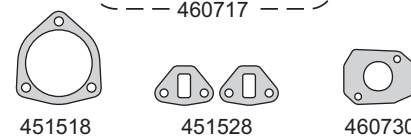

451518

451528

460730

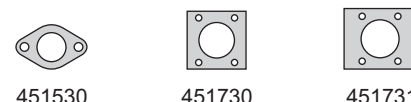

451530

451730

451731



G 56.82 x 2.62

460245

G 72.62 x 3.53

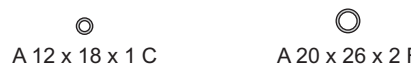

A 12 x 18 x 1 C

A 20 x 26 x 2 F

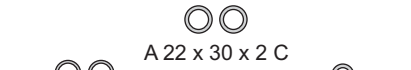

A 22 x 30 x 2 C



A 22 x 28 x 2 A

A 16 x 24 x 1 C



G 79.5 x 3



A 16 x 22 x 1.5 A

G 36 x 3

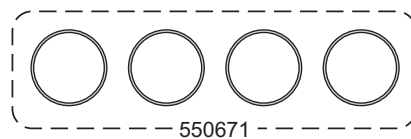

550671

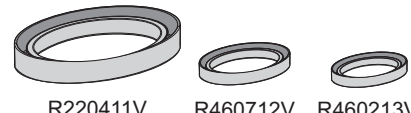

R220411V

R460712V

R460213V

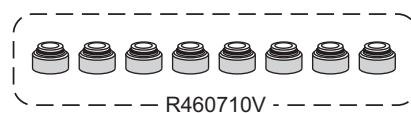

R460710V

PEUGEOT



Motor/Engine	Cm³	HP	Ø
XU10J2C (RFX)	1998	123	86

Citroën: ZX 1992/96 - Xantia 1993/98
Peugeot: 405 1992/... - 306 1993/...



Nº OE	Descripción/Description	Mat.	Ref.
	Jgo. de juntas superior	●	451995-R
2101-1003020	Junta tapa cilindros Ø 87 ± 1.50	NFT	1 460607
	Jgo. tornillos tapa cilin. (HAT55055/HAT55100)		B460300
0249.480	Junta tapa válvulas	N	1 460210/1
0349.700	Jgo. múltiple escape (4)	NFT	1 460215
0348.F60	Jgo. múltiple admisión (2)	N	1 460117
2105-1002064	Jgo. múltiple admisión (2)	V	1 460617
2101-1005155	Guarnición termostato	GS	1 460245
	Arandela A 16 x 24 x 1.5 A	AL	1
	Arandela A 7 x 12.5 x 2 C	CU	3
	Arandela A 14 x 18 x 1.5 A	AL	1
	Jgo. retén válvulas (8)	P	1 R450010P
0236.44	Retén árbol levas 36 x 50 x 8	V	1 R460213V

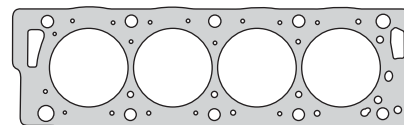

460607



460210/1

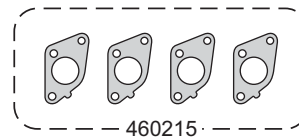

460215

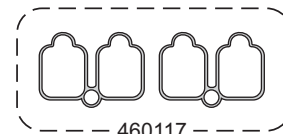

460117

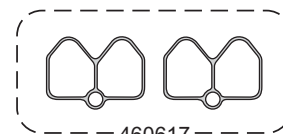

460617



460245



A 16 x 24 x 1.5 A



A 14 x 18 x 1.5 A



A 7 x 12.5 x 2 C



R460213V

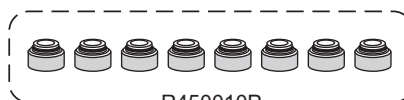

R450010P

PEUGEOT



Motor/Engine	Cm³	HP	Ø
DJ5TED (THX) 8V	2445	107	92

Citroën: Jumper TDI - Relay TDI 1997/...
Peugeot: Boxer TDI 1997/...

DIESEL



Nº OE	Descripción/Description	Mat.	Ref.
	Jgo. de juntas para motor		● 452000-R MLS
	Junta tapa cilindros Ø 93 \pm 1.40	ACG 1	452008
	Jgo. tornillos tapa cilindros (HAE14038)		B452000
	Sellador líquido - caucho de silicona		TRN0280R
	Junta tapa válvulas	N 1	470010
	Tapa bomba de agua	NFT 1	470014
	Múltiple escape	AC 1	452015
	Jgo. múltiple admisión (2)	NB 1	452017
	Placa termostato	NH 1	460232
	Lateral cuerpo bomba agua	NFT 1	470033
	Acople bomba agua	NFT 1	470034
	Junta	CB 1	470035
	Acople bomba de agua	NFT 1	470036
	O´ring entrada depresora G 44 x 2	GS	460340
	O´ring salida depresora G 16 x 2	GS	460341
	Kit de arandelas (5)	AC/GS 1	452075
	Arandela A 7 x 17 x 1 C	CU 4	
	Arandela A 6.5 x 10 x 1 C	CU 1	
	Arandela A 16.6 x 24 x 2.35	AC/GS 2	
	Arandela A 12.7 x 18 x 2.2	AC/GS 1	
	Arandela A 6.5 x 13.1 x 1.75	AC/GS 2	
	Kit de retenes completo		R452000
	Jgo. retén válvulas (8)	V 1	R452010V
	Retén bancada 98 x 120 x 7	V 1	R470011V
	Retén distribución 64 x 88 x 6	V 1	R470012V
	Retén árbol levas 35 x 50 x 7	V 1	R470013V
	Retén auxiliar 32 x 52 x 7	V 1	R471115V

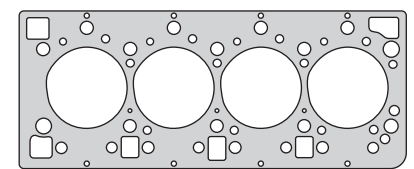

452008

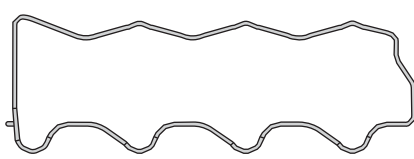

470010

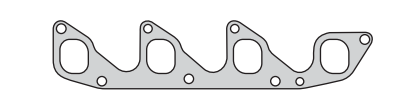

452015

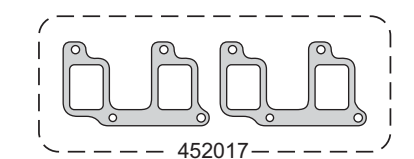

452017

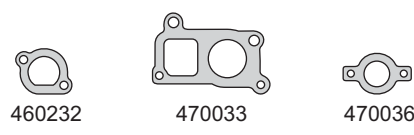

460232

470033

470036

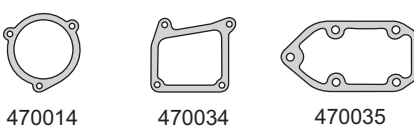

470014

470034

470035

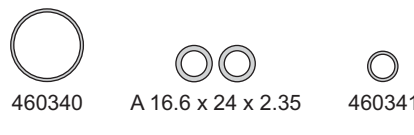

460340

A 16.6 x 24 x 2.35

460341

A 6.5 x 13.1 x 1.75

A 6.5 x 10 x 1 C

A 12.7 x 18 x 2.2

A 7 x 17 x 1 C

R470011V

R470012V

R470013V

R471115V



R452010V

PEUGEOT



Motor/Engine	Cm³	HP	Ø
TU5JP4 (NFU/N6A)	1587	106/109	78.5

Citroën: Berlingo - C3 Pluriel - Xsara 2000/...
C2 - C3 2002/... - 2004/...
Peugeot: 206 - 307 - Partner 2000/...
207 SW - 207 Compact



Nº OE	Descripción/Description	Mat.	1	2	Ref.
	Jgo. de juntas para motor			●	452100-R MLS
	Jgo. de juntas superior (MLS)		●		452195 MLS
	Junta tapa cilindros Ø 80 \geq 1.20				452107
0209.1E	Junta tapa cilindros Ø 80 \geq 0.60	MLS	1	1	452108
0204.81	Jgo. tornillos tapa cilindros (HAE14038)				B452100
0249.A9	Jgo. junta tapa válvulas (2)	N	1	1	452110
0304.C5	Junta para cárter	N	1	1	452111
1206.A0	O'ring bomba de agua G 74 x 3	GS	1	1	452114
0341.G2	Múltiple escape	AC	1	1	452115
0348.95	Jgo. múltiple admisión (4)	N	1	1	452117
1709.24	Salida de escape - hasta 2004	AC	1	1	452118
1709.33	Salida de escape - desde 8/2004	AC			452218
1340.60	Guarnición termostato G 45 x 4	GS			452119
0348.Q4	Caja comando inyección	N	1	1	452125
0258.56	Carga de aceite	GS			452129
	Arandela	AC			452131
	Jgo. junta tapa de válvulas (2)	PLAST	1	1	452133
0127.40	Cierre bancada trasera	GS		2	460235
1981.53	O'ring inyector G 7.52 x 3.53	GS	8	8	
0313.27	Arandela radiador aceite chica A 14 x 18 x 1.5 A	AL		1	
1206.98	O'ring distribución agua G 37.77 x 2.62	GS		1	
	Kit de retenes completo				R452100
0956.40	Jgo. retén válvulas (16)	V	1	1	R230510V
0514.74	Retén bancada 85 x 105 x 8	V	1	1	R560111V
0514.72	Retén distribución 42 x 66 x 8	V	1	1	R460712V
0807.246	Retén árbol de levas 38 x 50 x 6	V	2	2	R452113V

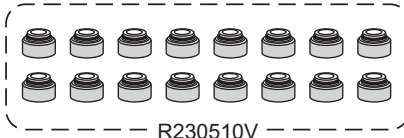
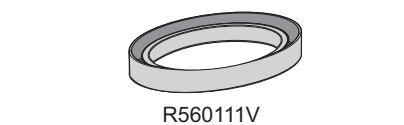
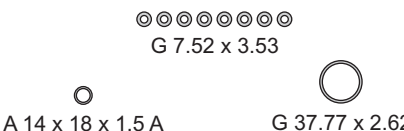
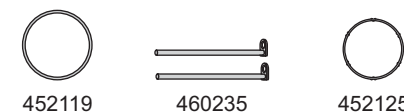
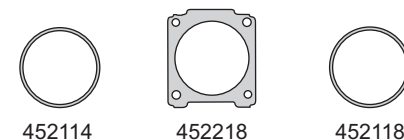
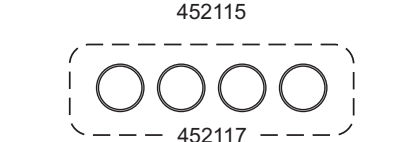
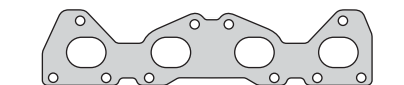
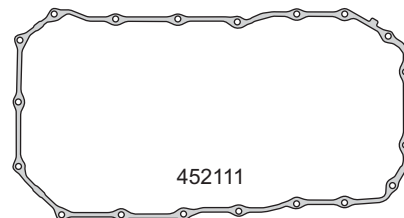
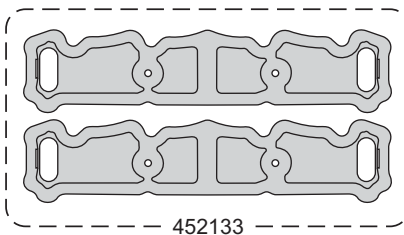
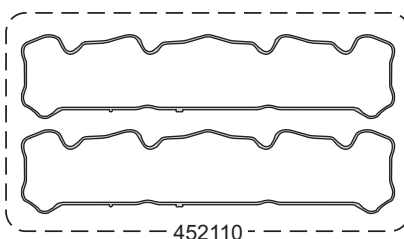
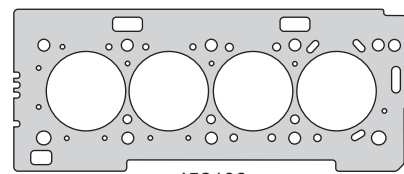

PEUGEOT



Motor/Engine	Cm³	HP	Ø
TU3JP (KFW)	1360	75	75
TU3JP (K6D)	1360	75	75
TU3JP (KFV)	1360	75	75
TU3-2 (K5A)	1360	75	75

Citroën: C2 - C3 - C3 Pluriel 2002/...
Berlingo 1997/...

Fiat: Qubo - Fiorino Qubo

Peugeot: 206/307 2001/... - Partner 2005/...
207 Compact



Nº OE	Descripción/Description	Mat.	Ref.
	Jgo. de juntas para motor		452200-R
	Jgo. de juntas superior		452295
0209.CJ	Junta tapa cilindros Ø 76 \pm 1.30 N.R.®	NFT	1 1 451707
0204.83	Jgo. tornillos tapa cilindros (HAE14038)		B470500
0249.54	Conj. junta tapa válvulas (3)	GS	1 1 460710
0304.30	Junta para cárter	NB	1 1 460711
01206.A0	O´ring bomba de agua G 75.87 x 2.62	N	1 1 451714
0347.K1	Múltiple escape	AC	1 1 452215
0342.E0	Jgo. múltiple admisión (4)	S	1 1 452217
1709.33	Salida de escape	AC	452218
	Junta cuello bomba de agua	NB	1 1 451619
0253.22	Arandela fijación tapa de válvulas	AC/GS	451730
0348.Q2	Guarnición caja admisión	GS	1 1 452231
	Arandela tapa válvulas	GS	2 2 451732
	Jgo. sellos camisa cilindros (4)	GS	1 550671
	Anillo G 45 x 49 x 5	GS	1
	Kit de retenes completo		R470300
0956.25	Jgo. retén válvulas (8)	V	1 R460710V
0514.74	Retén bancada trasera 85 x 105 x 8	V	1 R560111V
0514.72	Retén distribución 42 x 66 x 8	V	1 R460712V
0236.21	Retén árbol levas 36 x 50 x 8	V	1 R460213V

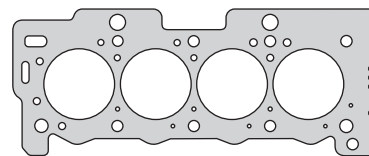

451707

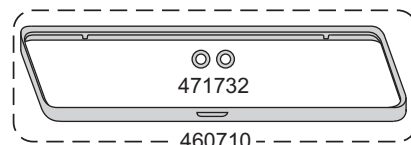

471732

460710

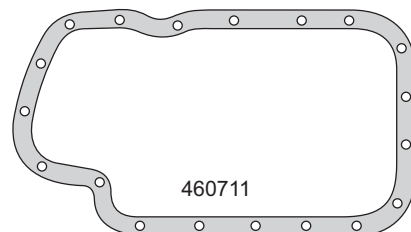

460711

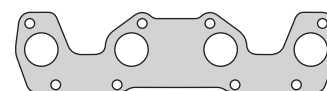

452215



452217

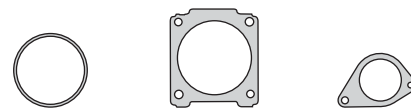

451714

452218

451619



452231



G 45 x 49 x 5



550671



R560111V



R460712V



R460213V



R460710V

PEUGEOT



Motor/Engine	Cm³	HP	Ø
XU7JP-XU7JB	1761	90/103	83

Citroën: Xantia 1997/01 - Xsara 1997/...
Peugeot: 306 1993/... - 405/406 1992/...
 406 1997/...



Nº OE	Descripción/Description	Mat.	Ref.
	Jgo. de juntas para motor		460100-R
	Jgo. de juntas superior	●	460195
	Junta tapa cilindros Ø 84 ± 1.20	NFT	460207-1.20
2101-1003020	Junta tapa cilindros Ø 84 ± 1.40	NFT	1 1 460207
0204.970	Jgo. tornillos tapa cilindros (HAE14038)		B460100
2101-1003270	Conj. junta tapa válvulas (4)	N	1 1 460610
2101-1003070	Junta para cárter	NB	1 1 460211
2101-1307046	Bomba de agua	NB	1 1 460214
2101-1002064	Jgo. múltiple escape (4)	NFT	1 1 460215
1723630	Múltiple escape - 405 SRI	NFT	1 1 460615
2105-1002064	Jgo. múltiple admisión (2) - 406	GS	1 1 460617
0348 F60	Jgo. múl. admisión (2) -306/405/Xantia/Xsara	GS	1 1 460117
	Salida de escape (todos)	NFT	1 1 460618
0365.260	Anillo caja mariposa admisión	GS	1 1 460430
2101-1008081	Placa termostato	NH	1 1 460232
2108-1107990	Bastón cierre bancada	GS	2 2 460235
2101-1005155	Guarnición termostato	GS	1 1 460245
	Jgo. suplemento camisas de cilindros (4)	GS	1 1 460270
2101-1303020	Arandela A 14 x 18 x 1.5 A	AL	1 1
2101-1307048	Arandela A 16 x 22 x 1.5 A	AL	1 1
2105-1005255	Arandela A 12 x 18 x 3 C	CU	1 1
2101-1011021	Arandela A 15 x 20 x 1 C	CU	1 1
	Arandela A 18 x 24 x 1.5 C	CU	1 1
2101-1106170	O'ring G 4.47 x 1.78	GS	5 5
2101-100608	Arandela A 8 x 12 x 1 C	CU	4 4
	Arandela A 8 x 14 x 1.5 F	NB	3 3
	Kit de retenes completo		R460200
2101-1107080	Jgo. retén válvulas (8)	V	1 R460210V
2101-1303017	Retén bancada 90 x 110 x 7	V	1 R460211V
2101-1303038	Retén distribución 42 x 62 x 7	V	1 R460212V
2101-1107015	Retén árbol levas 36 x 50 x 8	V	1 R460213V

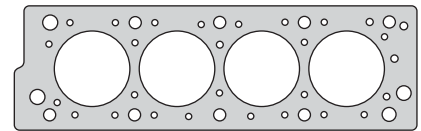

460207

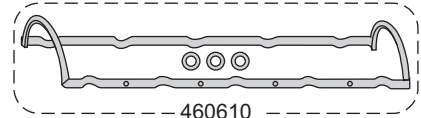

460610

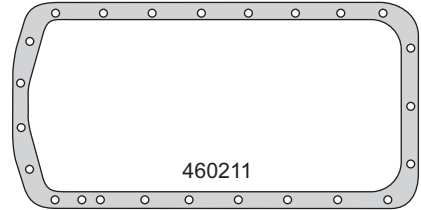

460211

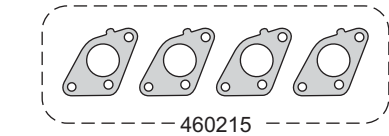

460215

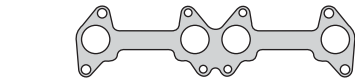

460615

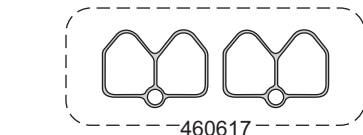

460617

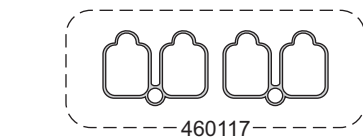

460117



460214



460245



460618



460430



460232



460235

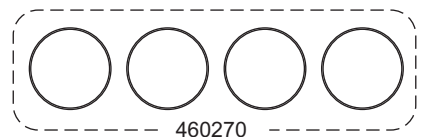

460270

- A 15 x 20 x 1 C ○
- A 14 x 18 X 1.5 A ○ A 16 x 22 x 1.5 A
- ○ ○ ○ ○
- G 4.47 x 1.78 ○
- A 12 x 18 x 3 C ○ A 18 x 24 x 1.5 C
- ○ ○ ○ ○
- A 8 x 12 x 1 C



R460212V



R460211V



R460213V



R460210V

PEUGEOT



Motor/Engine	Cm³	HP	Ø
XU92C	1905	96/104	83
XU92C	1905	102/125	83

Citroën: BX19 1984/93 - BX19 GTI 1983/93
 Peugeot: 306 - 405 - 309GT - 305GTX 1986/93



Nº OE	Descripción/Description	Mat.	Ref.
	Jgo. de juntas para motor		460200-R
	Jgo. de juntas superior		460295
	Junta tapa cilindros Ø 84 ± 1.40	NFT	460205
0209.E10	Junta tapa cilindros Ø 84 ± 1.40 N.R.	NFT	460207
	Jgo. de tornillos JTC (HAT55055/HAT55100)		B460200
0249.480	Jgo. junta tapa válvulas (4)	N	460210
0304.340	Junta para cárter	NB	460211
1206.460	Bomba de agua	NB	460214
0349.700	Jgo. múltiple escape (4)	NFT	460215
0348.910	Múltiple admisión inyección	NB	460217
1710.390	Salida de escape	NFT	460218
1339.530	Termostato	GS	460219
	Guarnición termostato	GS	460719
	Jgo. juntas carburador solex 34-34	VS	460220
	Base carburador	NB	460225
	Tapa carburador	CB	460226
1451.070	Bomba nafta	NB	460228
	Base bomba nafta	NB	550628
0164.300	Tapón cárter/bulbo agua block B16 x 22 x 2.4 CN	CN	450229
0310.040	Junta alojamiento termostato	CG	460229
1339.790	Colector tubo agua	NB	460230
1451.070	Superior bomba agua	CB	460231
0147.120	Placa termostato	NH	460232
1339.410	Alojamiento termostato	NB	460233
1339.640	Colector canalización agua	GS	460234
0127.050	Bastón cierre bancada	GS	460235
0163.530	Arandela tapón block A 22.5 x 29 x 2 C	CU	460236
1505.580	Tubo llenado aceite	GS	460237
	Arandela tubería aceite A 6 x 11 x 2 C	CU	460239
	O´ring G 19.18 x 2.46	GS	460240
	Múltiple admisión carburador	NB	460241
	Base carburador superior	NB	460242
	Guarnición termostato	GS	460245
0112.780	Jgo. suplemento camisa cilindros (4)	S	460270
	Arandela A 14 x 22 x 1.5 C	CU	
	Arandela A 7 x 17 x 1.5 FA	NB	3 3
	Arandela A 16 x 22 x 1.5 A	AL	4
	Kit de retenes completo		R460200
0119.060	Jgo. retén válvulas (8)	V	1 R460210V
0326.220	Retén bancada 90 x 110 x 7	V	1 R460211V
0514.150	Retén distribución 42 x 62 x 7	V	1 R460212V
0236.210	Retén árbol levas 36 x 50 x 8	V	1 R460213V

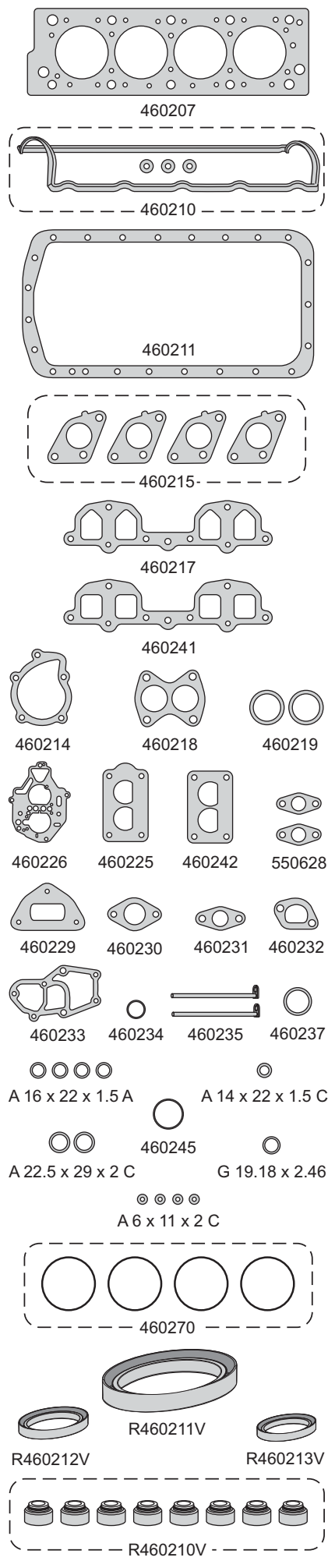

PEUGEOT



Motor/Engine	Cm³	HP	Ø
XUD9	1905	64/71	83

Citroën: Xantia - Dispatch - Xsara - Jumper
Hyundai: Lantra 1998/..
Lada: Niva 2121 - Aleko 1990/..
Peugeot: 205/305/306/309/405 - Express - Boxer
Rover: 218 - 418 1991/96
Suzuki: Vitara 1995/96



DIESEL

Nº OE	Descripción/Description	Mat.	Ref.
	Jgo. de juntas para motor		460301-R
	Jgo. de juntas para motor	●	460300-R 1M
	Jgo. de juntas para motor		460300-R 2M
	Jgo. de juntas para motor		460300-R 3M
	Jgo. de juntas superior		460395-1M
	Jgo. de juntas superior		460395-2M
	Jgo. de juntas superior		460395-3M
	Jgo. de juntas superior		460395-4M
0.209.S9	Junta tapa cilindros Ø 84 \pm 1.50	NFT 1	460307-1M
0.209.K8	Junta tapa cilindros Ø 84 \pm 1.60	NFT	460307-2M
0.209.K1	Junta tapa cilindros Ø 84 \pm 1.70	NFT	460307-3M
	Junta tapa cilindros Ø 84 \pm 1.80	NFT	460307-4M
0.204.65	Jgo. de tornillos JTC (HAT55055/HAT55100)		B460300
0.249.910	Conj. junta tapa válvula (4)	N 1 1	460310
0.304.340	Junta para cárter	NB 1	460211
1.206.460	Bomba de agua	NB 1	460214
0.349.780	Jgo. múltiple escape (2)	NFT 1 1	460316
0.348.J0	Múltiple admisión y escape	NFT 1 1	460317
0.365.34	Jgo. entre colec. adm. aspirado G 37 x 4 (4)	GS 1 1	460917
0.348.N8/P0	Jgo. múltiple admisión aspirado (3)	NB 1 1	470617
0.348.98/99	Jgo. múltiple admisión (3)	NB 1 1	470917
1.710.99	Salida de escape	AC 1 1	460318
1.339.730	Cuerpo termostato	NB 1 1	460319
	Arandela B 16 x 22 x 2.4 CN	CN	450229
0.236.32	Junta porta varilla a nivel aceite	CG 1	460229
0.147.140	Porta retén frente motor	CB 1	460329
0.147.120	Placa termostato	NH 1 1	460232
1.339.620	Base termostato	NB 1 1	460332
1.339.410	Inspección	NB 1	460333
0.236.320	Base termostato	NB 1 1	460334
0.197.050	Bastón bancada	GS 2	460235
	Arandela parallamas inyector	AC	560036
	Arandela A 7 x 17 x 1.5 FA	NB 3 3	460339
7703061078	Arandela base inyector A 16 x 21 x 2 C	CU 4 4	500240
0.455605	O´ring entrada depresora G 44 x 2	GS 1 1	460340
0.455606	O´ring salida depresora G 16 x 2	GS 1 1	460341
	Cierre termostato	GS 1 1	550641
	O´ring G 18.72 x 2.62	GS 1	
	O´ring G 29.87 x 1.78	GS 1	
	Arandela A 6 x 11 x 2 C	CU 2	
	Arandela A 14 x 17.2 x 2 C	CU 2	
1.981.050	Arandela A 12 x 18 x 3 A	AL 1	
0.164.300	Arandela A 22 x 29 x 1.5 A	AL 1	
0.956.220	Arandela cierre termostato A 15 x 21 x 1.5 C	CU 2	
	Arandela A 7 x 14 x 1 H	H 4	
0.313.270	Arandela tapón cárter A 14 x 21 x 2 C	CU 2	
	Arandela A 16 x 21 x 1.5 C	CU 2	
	Arandela A 16 x 22 x 1.5 A	AL 3	
	Kit de retenes completo		R460300
0.119.060	Jgo. retén válvulas (8)	V 1	R460210V
0.326.220	Retén bancada 90 x 110 x 7	V 1	R460211V
0.514.150	Retén distribución 42 x 62 x 7	V 1	R460212V
0236.44	Retén árbol de levas 35 x 50 x 7	V 1	R470013V

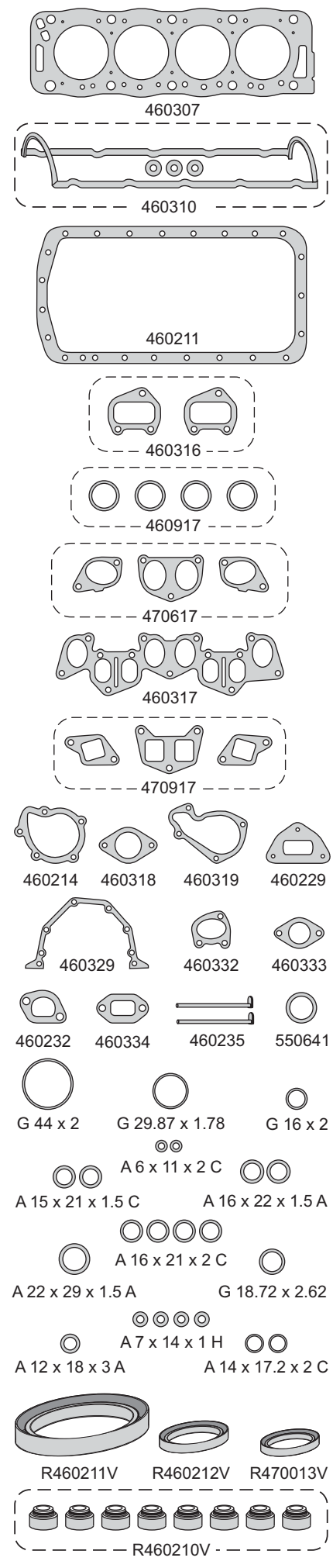

PEUGEOT



Motor/Engine **Cm³** **HP** **Ø**

XU10 J2TE **1998** **150** **86**

Peugeot: 406 - 605 - 806 Turbo 1996/...



Nº OE	Descripción/Description	Mat.			Ref.
	Jgo. de juntas para motor			●	460400-R
	Jgo. de juntas superior		●		460495
2101-1003020	Junta tapa cilindros Ø 87 \pm 1.50 N.R.	NFT	1	1	460607
	Jgo. de tornillos JTC (HAT55055/HAT55100)				B460300
0249.480	Junta tapa válvulas	N	1	1	460210/1
2101-1003070	Junta para cárter	NB		1	460211
2101-1307046	Bomba de agua	NB		1	460214
	Jgo. múltiple escape (4)	NFT	1	1	460215
1723630	Múltiple escape SRI	NFT		1	460615
0348.N00	Jgo. múltiple admisión (2)	GS	1	1	460417
	Salida de escape	NFT		1	460618
2101-1008081	Placa termostato	NH		1	460232
0365.260	Anillo caja mariposa admisión	GS	1	1	460430
	Guarnición sello de goma A 16.8 x 24 x 1.5	AC/GS	1		460431
2108-1107990	Bastón cierre bancada	GS		2	460235
1339.83	Guarnición distribuidora de agua	GS		1	470637
2101-1005155	Guarnición termostato	GS	1	1	460245
2101-1303020	Arandela A 14 x 18 x 1.5 A	AL	1	1	
2101-1307048	Arandela A 16 x 22 x 1.5 A	AL		1	
2105-1005255	Arandela A 12 x 18 x 3 C	CU		1	
2101-1011021	Arandela A 16 x 20 x 1.5 C	CU		1	
	Arandela A 18 x 22 x 1.5 C	CU		1	
2101-1106170	O'ring G 4.47 x 1.78	GS		5	
2101-100608	Arandela A 8 x 11 x 1 C	CU		4	
	Arandela A 7 x 12.5 x 2 C	CU	3		
	Kit de retenes completo				R460200
2101-1107080	Jgo. retén válvulas (8)	V		1	R460210V
2101-1303017	Retén bancada 90 x 110 x 7	V		1	R460211V
2101-1303038	Retén distribución 42 x 62 x 7	V		1	R460212V
2101-1107015	Retén árbol levas 36 x 50 x 8	V		1	R460213V
0236.240	Retén árbol levas trasero 32 x 45 x 8	S			R460414S

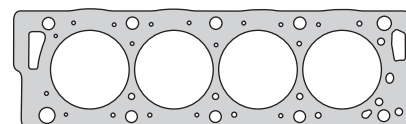

460607



460210/1

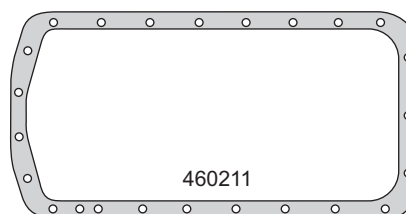

460211



460615

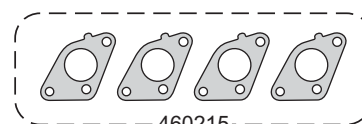

460215-

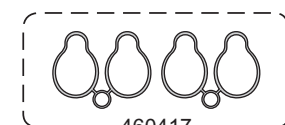

460417



460214



460618



460232



460430



470637



460235



460245

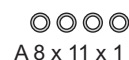

A 8 x 11 x 1 C

A 14 x 18 x 1.5 A

A 16 x 22 x 1.5 A

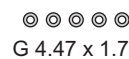

G 4.47 x 1.78

A 7 x 12.5 x 2 C

A 18 x 22 x 1.5 C

A 12 x 18 x 3 C

A 16 x 20 x 1.5 C



R460211V



R460212V



R460213V



R460414S



R460210V -

PEUGEOT



Motor/Engine	Cm³	HP	Ø
108C - XV3/5/8	954	45	70
109/5-109/K	1124	57	72
XW3/7	1124	55/57	72
129/5-XZ5	1219	57/64	75
150	1360	70/72	75
XY6B-XY7/8	1360	70	75

Citroën: C15 1985/... - Visa 10 1986/88
 Visa 11 - C15 197/85, 1985/...
 Visa GT - BX14 1982/85, 1985/...
Peugeot: 104 - 205 1972/86, 1986/87
 205 1986/87 - 104 1986/...
 205 1986/87



Nº OE	Descripción/Description	Mat.	Ref.
	Jgo. de juntas para motor	●	460500-R
	Jgo. de juntas para motor		451800-R
	Junta tapa cilindros Ø 76.5 ± 1.25	NFT 1	460507
	Junta tapa cilindros Ø 76 ± 1.20	NFT 1	451807
	Junta tapa válvulas	GS 1	460510
	Junta para cárter	NB 1	460511
	Frente distribución BV4	GS 1	460512
	Frente distribución BV5	GS 1	460513
	Bomba de agua	NB 1	460514
	Múltiple escape	NFT 1	460516
	Jgo. múltiple admisión	NB 1	460517
	Salida de escape	FCH 1	450018
	Base carburador	NB 1	460525
	Base carburador	NB 1	460526
	Base bomba nafta	NB 1	550428
	Frente distribución	GS 1	460540
	Frente distribución	GS 1	460541
	Cubierta trasera embrague	NB 1	460552
	Cubre volante embrague	NB 1	460553
	Jgo. retén vávulas (8)	V 1	R460510V

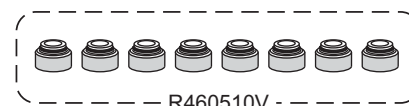
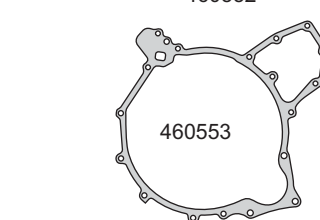
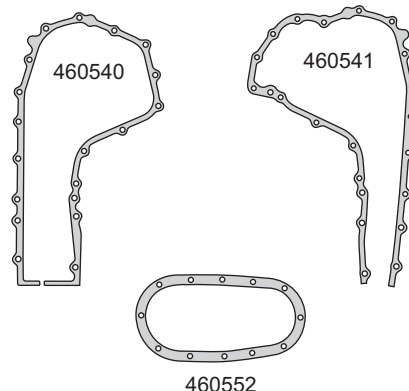
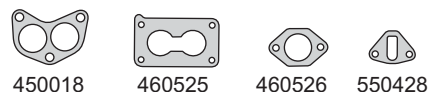
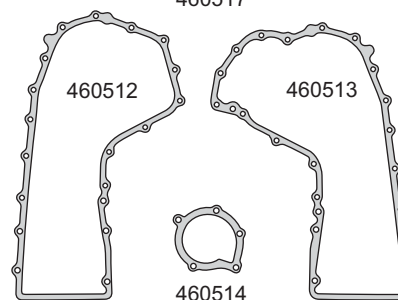
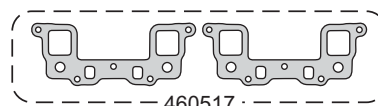
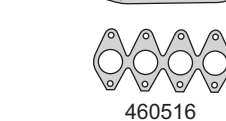
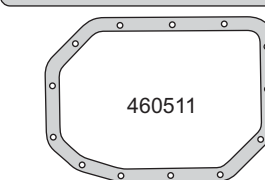
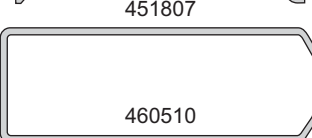
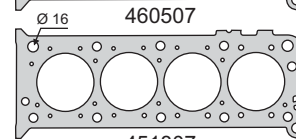
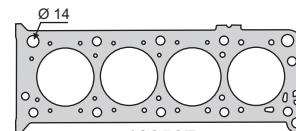

PEUGEOT



Motor/Engine **Cm³** **HP** **Ø**

XU10J2C **1998** **123** **86**

Citroën: ZX 1992/... - Xantia 1993/98
Peugeot: 405 1992/... - 306 1993/...



Nº OE	Descripción/Description	Mat.	1	2	Ref.
	Jgo. de juntas para motor			●	460600-R
	Jgo. de juntas superior		●		460695
2101-1003020	Junta tapa cilindros Ø 87 ± 1.50	NFT	1	1	460607
	Jgo. de tornillos JTC (HAT55055/HAT55100)				B460300
2101-1003270	Conj. junta tapa válvulas (4)	N	1	1	460610
2101-1003070	Junta para cárter	NB		1	460211
2101-1307046	Bomba de agua	NB		1	460214
1723630	Múltiple escape SRI	NFT	1	1	460615
2101-1002064	Jgo. múltiple escape (4)	NFT	1	1	460215
	Jgo. múltiple admisión (2)	GS	1	1	460417
2105-1002064	Jgo. múltiple admisión (2)	GS	1	1	460617
	Salida de escape	NFT			460618
	Anillo termostato	GS			460719
0.147.140	Porta retén trasero motor	CB		1	460329
0365.260	Anillo caja mariposa admisión	GS		1	460430
2101-1008081	Placa termostato	NH	1	1	460232
1339.410	Alojamiento termostato	NB	1	1	460233
	Arandela radiador aceite chica B 14 x 18 x 2 CN	CN			150034
2108-1107990	Bastón cierre bancada	GS		2	460235
	Guarnición distribución agua	GS		1	470637
2101-1005155	Guarnición termostato	GS	1	1	460245
2101-1303020	Arandela B 14 x 20 x 2.5 CN	CN			
2101-1307048	Arandela blindada A 16 x 22 x 1.5 A	AL		1	
2105-1005255	Arandela A 12 x 18 x 3 C	CU		1	
2101-1011021	Arandela A 15 x 20 x 1 C	CU		1	
	Arandela A 18 x 23 x 1 C	CU		1	
	Arandela A 8 x 14 x 1.5 F	NB	3	3	
2101-1106170	O'ring G 4.47 x 1.78	GS	5	5	
2101-100608	Arandela A 8 x 12 x 1 C	CU			
	Arandela A 14 x 18 x 1.5 A	AL		1	
	Kit de retenes completo				R460200
2101-1107080	Jgo. retén válvulas (8)	V	1	1	R460210V
2101-1303017	Retén bancada 90 x 110 x 7	V	1	1	R460211V
2101-1303038	Retén distribución 42 x 62 x 7	V	1	1	R460212V
2101-1107015	Retén árbol levas 36 x 50 x 8	V	1	1	R460213V

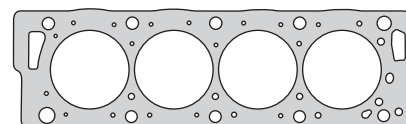

460607

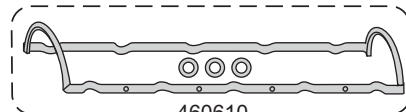

460610

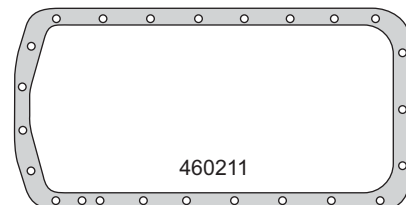

460211



460615

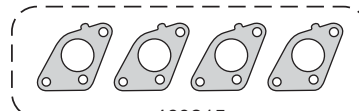

460215

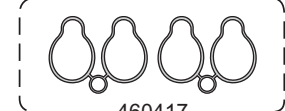

460417

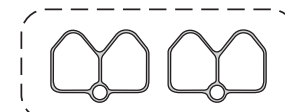

460617

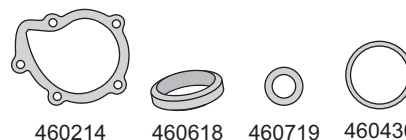

460214 460618 460719 460430

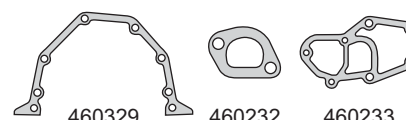

460329 460232 460233



460235 470637 460245

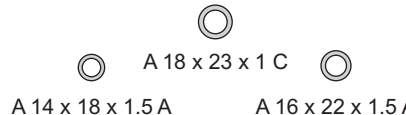

A 18 x 23 x 1 C
A 14 x 18 x 1.5 A A 16 x 22 x 1.5 A



G 4.47 x 1.78
A 8 x 12 x 1 C A 12 x 18 x 3 C
A 15 x 20 x 1 C

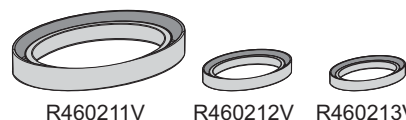

R460211V R460212V R460213V

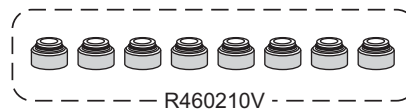

R460210V

PEUGEOT



Motor/Engine	Cm³	HP	Ø
TU1/M/MZ/K/Z	1124	55/60	72
TU24/M4A	1294	94/102	75
TU3MC/JPI/A	1360	65/70	75
TU3S/M/K	1360	75/80	75

Citroën: AX 11 - BX 11 - C15 - AX 14 - AX GT
 AX Sport - BX 14 - C15 1986/...
 ZX 1991/98 - Saxo - Xsara 1996/...
Peugeot: 106 1991/... - 306 93/97 - 205 1987/96
 309 - 205 Rallye 1988/93 - 405 1987/96
 Partner 96/... - 206 1998/...



Nº OE	Descripción/Description	Mat.	Ref.
	Jgo. de juntas para motor		460700-R
	Jgo. de juntas superior	●	460795
	Junta tapa cilindros Ø 76 ± 1.40 N.R. HAE14038	NFT 1 1	460707
	Jgo. tornillos tapa cilindros (HAE14038)		B470500
	Conj. junta tapa válvulas (3)	GS 1 1	460710
	Junta para cárter	NB 1 1	460711
	Jgo. múltiple escape (2)	NFT 1 1	460716
	Jgo. múltiple escape (2)	AC	460715
	Jgo. múltiple admisión (2)	NB 1 1	460717
	Salida de escape	NFT 1 1	460718
	Junta cuello bomba de agua	NB 1 1	451619
	Guarnición termostato	GS	460719
	Junta asiento carburador	NB 1 1	460730
	Junta	NB 1 1	460731
	Arandela tapa válvulas	GS 2 2	451732
	Guarnición termostato	GS 1 1	460245
	Jgo. suplemento camisas cilindros (4)	S 1	550671
	Arandela A 12 x 18 x 1 C	CU 1	
	Arandela A 22 x 30 x 2 C	CU 2	
	Arandela A 8 x 20 x 1.5 F	NB	
	Arandela A 16 x 22 x 1.5 A	AL 2	
	O'ring G 79.5 x 3	GS 1	
	O'ring G 37.47 x 3	GS 3 3	
	O'ring G 21.82 x 3.53	GS 2	
	O'ring G 58.42 x 2.62	GS 1	
	Kit de retenes completo		R470300
	Jgo. retén válvulas (8)	V 1	R460710V
0514.74	Retén bancada 85 x 105 x 8	V 1	R560111V
0514.72	Retén distribución 42 x 66 x 8	V 1	R460712V
0236.44	Retén árbol de levas 36 x 50 x 8	V 1	R460213V

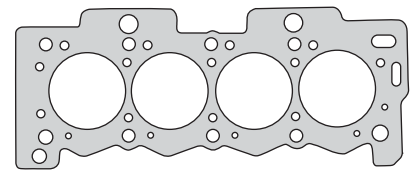

460707

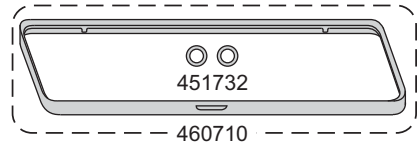

451732

460710

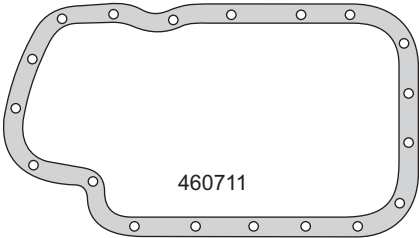

460711

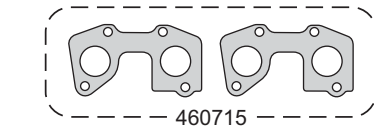

460715

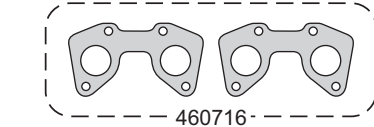

460716

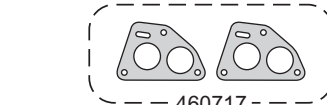

460717

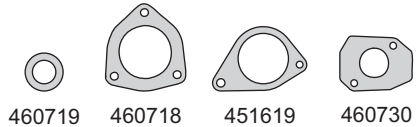

460719 460718 451619 460730

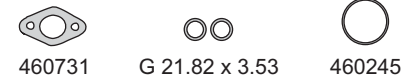

460731 G 21.82 x 3.53 460245



A 12 x 18 x 1 C A 22 x 30 x 2 C

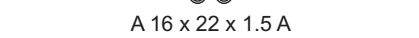

A 16 x 22 x 1.5 A



G 58.42 x 2.62 G 37.47 x 3 G 79.5 x 3

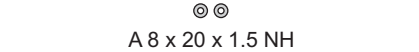

A 8 x 20 x 1.5 NH



550671



R560111V



R460712V



R460213V



R460710V

PEUGEOT



Motor/Engine	Cm³	HP	Ø
XU7JP4 (DOHC) 16V	1761	112	83

Citroën: Xsara 1997/... - Xantia 1995/96
Xantia 1997/2001 - ZX 1997/98
Peugeot: 306 1997/... - 406 1995/96
406 1997/...



Nº OE	Descripción/Description	Mat.	Ref.
B197.X170	Jgo. de juntas para motor Jgo. de juntas superior		460800-R 460895
B209.930	Jta. tapa cilindros Ø 84 ± 1.40	NFT	1 1 460807
B204.800	Jgo. tornillos tapa cilindros (HAE14038)		B460800
0249.A2/A3	Conj. junta tapa válvulas (2)	GS	1 1 460810
0340.340	Junta para cárter	NB	1 1 460211
1206.A40	Bomba de agua	NB	1 1 460214
0349.400	Múltiple escape - Hasta 1996	NFT	1 1 460815
0349.H0	Múltiple escape - Desde 1997	AC	460815-1
0348.C8	Múltiple admisión	NB	1 1 460817
1340.330	Arandela A 6.7 x 13.5 x 1	AC/GS	460830
1340.330	Alojamiento termostato	NB	1 1 460833
0127.050	Bastón cierre bancada	GS	2 460235
	Tubo llenado aceite	GS	1 1 460237
0348.K6	Jgo. múltiple admisión (5) 1997/...	GS	1 460841
	Múltiple admisión mariposa	GS	1 460842
1340.480	Guarnición termostato	GS	1 1 460245
0112.780	Jgo. suplemento camisas cilindros (4)	CU	1 460270
	Arandela A 7 x 14 x 1 A	AL	10 10
	Arandela A 16 x 21 x 1.5 C	CU	1
	Arandela A 14 x 18 x 1.5 A	CU	1
	Arandela A 6 x 10.5 x 2 C	AL	1
	Arandela A 6 x 10 x 1 A	GS	3
	O'ring G 9.25 x 1.78	GS	1
	Kit de retenes completo		R460800
0956.420	Jgo. retén válvulas (16)	V	1 R460810V
0127.280	Retén bancada 90 x 110 x 7	V	1 R460211V
0326.220	Retén distribución 42 x 62 x 7	V	1 R460212V
0236.440	Retén árbol levas 36 x 50 x 8	V	2 R460213V

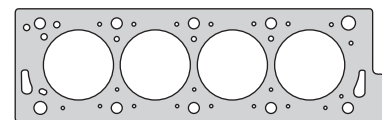

460807

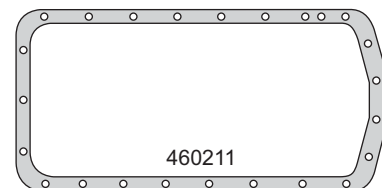

460211

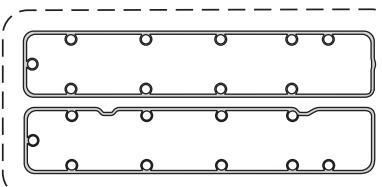

460810

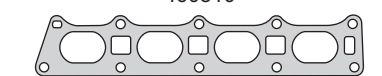

460815

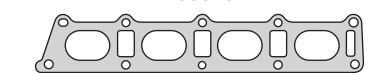

460815-1



460817



460841/1

460842

460841

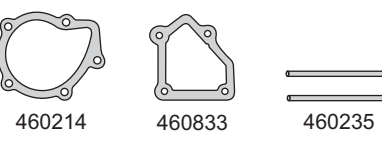

460214

460833

460235

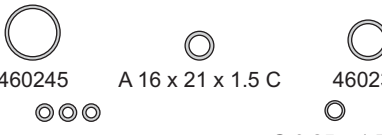

460245

A 16 x 21 x 1.5 C

460237

A 6 x 10 x 1 A

G 9.25 x 1.78

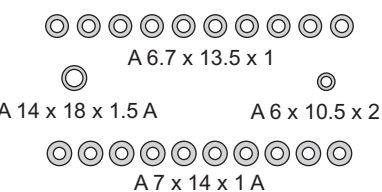

A 6.7 x 13.5 x 1

A 14 x 18 x 1.5 A

A 6 x 10.5 x 2 C

A 7 x 14 x 1 A



460270



R460211V



R460212V

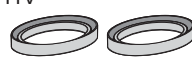

R460213V

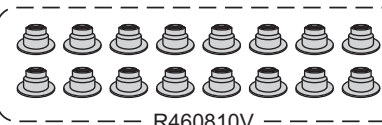

R460810V

PEUGEOT



Motor/Engine	Cm³	HP	Ø
XUD9TE/TF	1905	90/92	83
XUD9SD/TF	1905	76/90	83
D8B/DHX	1905	92	83

Citroën: Xantia - ZX - Jumpy - Dispatch
Jumper TD - 1993/... - Xsara TD 1997/...

Fiat: Ducato TD 1994/... - Scudo TD 1995/01

Peugeot: 306/405 TD 1992/97 - 406 TD 1995/99
806TD - Expert TD - Boxer TD 1995/...

Suzuki: Vitara TD 1996/...

DIESEL



Nº OE	Descripción/Description	Mat.	Ref.
	Jgo. de juntas para motor		460301-R
	Jgo. de juntas superior (MLS)		460995-1M MLS
	Jgo. de juntas superior (MLS)		460995-2M MLS
	Jgo. de juntas superior (MLS)		460995-3M MLS
	Jgo. de juntas superior (MLS)		460995-4M MLS
	Jgo. de juntas superior (MLS)		460995-5M MLS
	Junta tapa cilindros Ø84 ± 1.50	NFT	460907-1M
	Junta tapa cilindros Ø84 ± 1.60	NFT	460907-2M
	Junta tapa cilindros Ø84 ± 1.70	NFT	460907-3M
9621917180	Junta tapa cilindros Ø84 ± 1.34	MLS 1	460908-1M
9621917280	Junta tapa cilindros Ø84 ± 1.38	MLS	460908-2M
9621917380	Junta tapa cilindros Ø84 ± 1.42	MLS	460908-3M
9621917480	Junta tapa cilindros Ø84 ± 1.50	MLS	460908-4M
9621917580	Junta tapa cilindros Ø84 ± 1.55	MLS	460908-5M
0204.65	Jgo. de tornillos JTC (HAT55055/HAT55100)		B460900
0249.910	Conj. junta tapa válvula (4)	N 1 1	460310
0.304.26	Junta para cárter	NB 1	460211
1.206.460	Bomba de agua	NB 1	460214
0.349.47	Jgo. múltiple admisión (2)	NFT 1 1	460316
0.348.50	Múltiple admisión y escape turbo	NFT 1 1	460317
0.348.N1/N2	Jgo. múltiple admisión (3)	NB 1 1	470617
0348.98/99	Jgo. múltiple admisión (3)	NB 1 1	470917
1721.01	Salida de escape	AC 1 1	460318
1339.62	Cuerpo termostato	NB 1 1	460319
	Arandela B 16 x 22 x 2.4 CN	CN	450229
0.164.300	Junta alojamiento termostato	CG 1	460229
0.147.140	Junta porta retén b/atras	CB 1	460329
0.147.120	Placa termostato	NH 1 1	460232
1.339.620	Base termostato	NB 1 1	460332
1.339.410	Inspección	NB 1	460333
0.236.320	Base termostato	NB 1 1	460334
0.197.050	Bastón bancada	GS 2	460235
1.981.020	Arandela parallamas pico inyector	AC	560036
	Arandela A 7 x 14 x 1 H	H 4	460339
7703061078	Arandela base inyector A 16 x 21 x 2 C	CU 4 4	500240
0.455605	O´ring entrada depresora G 44 x 2	GS 1 1	460340
0.455606	O´ring salida depresora G 16 x 2	GS 1 1	460341
	Cierre termostato	GS 1 1	550641
1.981.050	Arandela A 12 x 18 x 3 A	AL 1	
0.164.300	Arandela A 22 x 29 x 1.5 A	AL 1	
0.127.050	Arandela tapa válvula A 7 x 17 x 1.5 F	NB 3 3	
	Arandela cierre termostato A 16 x 21 x 1.5 C	CU 2	
	Arandela A 6 x 11 x 2 C	CU 2	
	Arandela A 14 x 17.2 x 2 C	CU 2	
	Arandela A 16 x 22 x 1.5 A	AL 3	
	O´ring G 18.72 x 2.62	GS 1	
	O´ring G 29.87 x 1.78	GS 1	
	O´ring G 37 x 4	GS 4 4	
	Kit de retenes completo		R460300
0956.22	Jgo. retén válvulas (8)	V 1	R460210V
0127.28	Retén bancada 90 x 110 x 7	V 1	R460211V
0326.22	Retén distribución 42 x 62 x 7	V 1	R460212V
0236.15	Retén árbol de levas 35 x 50 x 7	V 1	R470013V

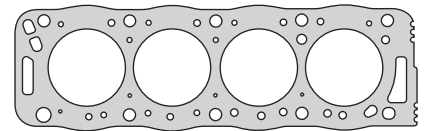

460907

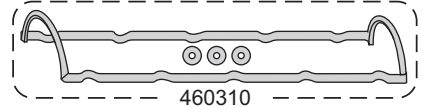

460310

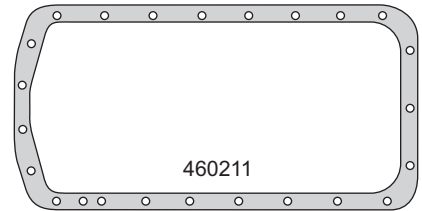

460211

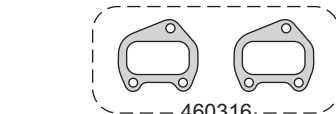

460316



460317

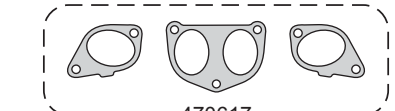

470617

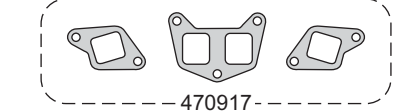

470917



460214 460318 460319 460229



460329 460332 460333

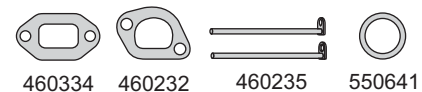

460334 460232 460235 550641



G 44 x 2 G 37 x 4 G 16 x 2

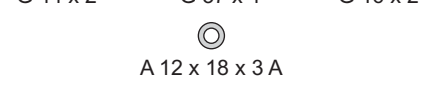

A 12 x 18 x 3 A



A 16 x 21 x 2 C A 16 x 22 x 1.5 A

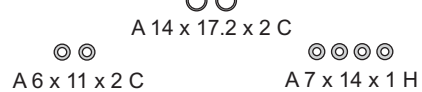

A 14 x 17.2 x 2 C A 6 x 11 x 2 C A 7 x 14 x 1 H

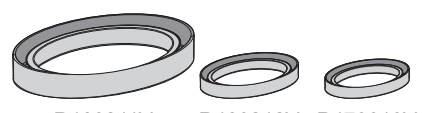

R460211V R460212V R470013V



R460210V

PEUGEOT



Motor/Engine	Cm³	HP	Ø
XU7JB	1761	90	83

Citroën: Berlingo 1997/...
Peugeot: Partner 1997/...



Nº OE	Descripción/Description	Mat.	Ref.
	Jgo. de juntas para motor		461100-R
	Jgo. de juntas superior	●	461195
	Junta tapa cilindros Ø 84 ± 1.40	NFT	1 1 460207
0204.89	Jgo. tornillos tapa cilindros (HAE14038)		B460100
2101-1003270	Jgo. junta tapa válvulas (4)	N	1 1 460610
2101-1003070	Junta para cárter	NB	1 1 460211
2101-1307046	Bomba de agua	NB	1 1 460214
1723630	Múltiple escape SRI	NFT	1 1 460615
0348.263	Jgo. múltiple admisión (4)	S	1 1 461117
	Salida de escape	NFT	1 1 460618
0365.260	Anillo caja mariposa admisión	S	1 1 460430
2101-1008081	Placa termostato	NH	1 1 460232
2108-1107990	Bastón cierre bancada	GS	2 2 460235
2101-1005155	Guarnición termostato	GS	1 1 460245
2101-1303020	Arandela A 14 x 18 x 1.5 A	AL	1 1
2101-1307048	Arandela A 16 x 22 x 1.5 A	AL	1 1
2105-1005255	Arandela A 12 x 18 x 3 C	CU	1 1
2101-1011021	Arandela A 15 x 20 x 1 C	CU	1 1
	Arandela A 8 x 14 x 1.5 F	NB	3 3
	Arandela A 18 x 23 x 1 C	CU	1 1
2101-1106170	O'ring G 4.47 x 1.78	GS	5 5
2101-100608	Arandela A 8 x 12 x 1 C	CU	4 4
	Kit de retenes completo		R460200
2101-1107080	Jgo. retén válvulas (8)	V	1 R460210V
2101-1303017	Retén bancada 90 x 110 x 7	V	1 R460211V
2101-1303038	Retén distribución 42 x 62 x 7	V	1 R460212V
2101-1107015	Retén árbol levas 36 x 50 x 8	V	1 R460213V

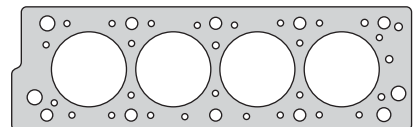

460207

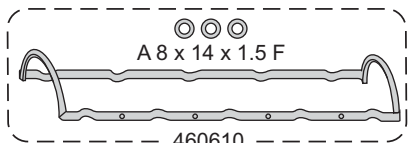

A 8 x 14 x 1.5 F

460610

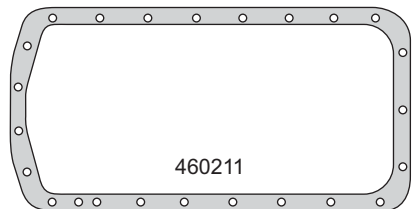

460211



460615

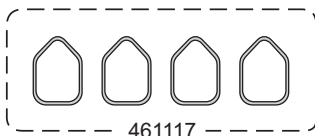

461117



460214



460618



460245



460430



460232



460235



A 14 x 18 x 1.5 A



A 16 x 22 x 1.5 A



G 4.47 x 1.78



A 8 x 12 x 1 C



A 12 x 18 x 3 C



A 8 x 14 x 1.5 F



A 15 x 20 x 1 C



A 18 x 23 x 1 C



R460211V



R460212V



R460213V



R460210V

PEUGEOT



Motor/Engine	Cm ³	HP	Ø
ZEJ	1995	110	88
ZDJ	2165	123	88

Peugeot: 505 Inyección ZEJ - 1979/...
505 GTI ZDJ - 1982/91



Nº OE	Descripción/Description	Mat.	Ref.
	Jgo. de juntas para motor		461200-R
0209.D9	Junta tapa cilindros Ø 89 ± 1.40	NFT 1	550605
	Junta tapa cilindros Ø 89 ± 1.20	NFT	550607
0204.39	Jgo. tornillos tapa cilindros (HAS19038)		B461200
0249.43	Conj. juntas tapa válvulas (4)	GS 1	550610
0304.20	Junta para cárter	CG 1	550611
1019.160	Eje intermedio distribución	NB 1	550613
0349.90	Múltiple escape	NFT	550616
1710.85	Salida de escape	FCH 1	450318
1206.740	Bomba de agua a block	NB 1	550619
	Base bomba aceite	NB 1	550627
7700622283	Base bomba nafta	NB 2	550628
0164.300	Arandela tapón cárter B 16 x 22 x 2.4 CN	CN	450229
0252.120	Arandela tapa válvulas A 8 x 18 x 1.5 F	NB 3	550630
1451.160	Cámara agua tapa cilindros	NB 1	550632
7700629742	Anillo o´ring base distribución G 39 x 3	GS 1	550633
1206.740	Cuerpo bomba de agua	NB 1	550634
0348.42	Jgo. múltiple admisión (4)	NB 1	560637
	O´ring tapón block mando b/ac. 47.3 x 2	GS 1	550638
1340.220	Termostato	NB 1	550639
1458.030	Llenado de aceite	CG	450041
1339.660	Anillo termostato	GS 1	550641
	Jgo. juntas caja velocidades	VS	550650
0127.260	Jgo. cierre bancada (4)	GS 1	550658
0304.20	Junta para cárter	CGT	550660
0112.740	Jgo. suplemento camisa cilindros (4)	S 1	550670
0304.20	Junta para cárter	CB	550682
	Arandela A 16 x 22 x 1.5 A	AL 1	
	Kit de retenes completo		R461200
0956.22	Jgo. retén válvulas (8)	T 1	R550610T
0127.28	Retén bancada 90 x 110 x 13	P 1	R550611P
0127.11	Retén distribución 50 x 68 x 10	P 1	R550612P
0236.09	Retén árbol levas 35 x 47 x 7	P 1	R550613P
	Retén auxiliar 30 x 40 x 7	P 1	R550615P

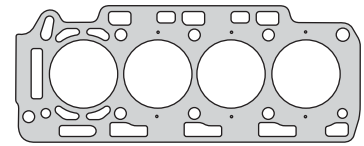

550605



A 8 x 18 x 1.5 F

550610

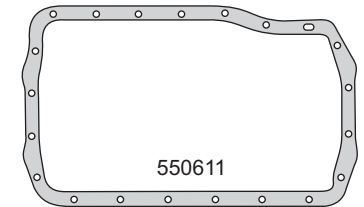

550611

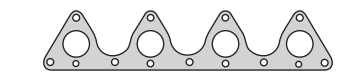

550616



560637

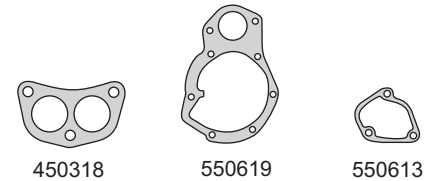

450318

550619

550613



550627

550628

550632

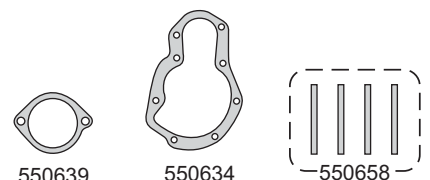

550639

550634

550658



G 39 x 3

550641

G 47.3 x 2

A 16 x 22 x 1.5 A



550670



R550611P



R550612P

R550613P

R550615P

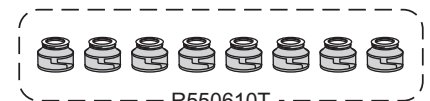

R550610T

PEUGEOT



Motor/Engine	Cm³	HP	Ø
XUD11BTE/ATE P8C Iny. Indirecta	2088 2088	110 109	86 86

Citroën: XM TD 1989/97, 1994/00 - Jumpy TD
Jumper TD - Synergie TD - Dispatch TD
Evasión TD 1996/... - Xantia TD 1995/98

Fiat: Ulysse TD 1996/99

Lancia: Zeta TD 1996/00

Peugeot: 406/605/806TD 1995/98



DIESEL

Nº OE	Descripción/Description	Mat.	Ref.
0197.H0	Jgo. de juntas para motor		461501-R
0209.R5	Junta tapa cilindros Ø 86 \pm 1.52	MLS	461508-1M
0209.R6	Junta tapa cilindros Ø 86 \pm 1.57	MLS	461508-2M
0209.R7	Junta tapa cilindros Ø 86 \pm 1.62	MLS	461508-3M
0209.R8	Junta tapa cilindros Ø 86 \pm 1.67	MLS	461508-4M
0209.T4	Junta tapa cilindros Ø 86 \pm 1.72	MLS	461508-5M
0209.R4	Junta tapa cilindros Ø 86 \pm 1.77	MLS	461508-SM
0204.99	Jgo. tornillos tapa cilindros (HAE14038)		B461500
0249.70	Junta tapa de válvulas	S	461510
0304.34	Junta para cárter	NB	460211
1206.A4	Tapa bomba de agua	NB	460214
1201.C50	Tapa bomba de agua	NB	461514
0349.76	Múltiple escape	AC	461515
0349.76/1	Múltiple escape	MLS	461515-1
0348.96	Múltiple admisión	NB	461517
	Arandela tapón cárter B16 x 22 x 2.4 CN	CN	450229
0236.320	Porta varilla nivel aceite	CG	460229
0236.40	Plaqueta tapa de cilindros	NB	461530
	Plaqueta block	NB	461531
1339.62	Base termostato	NB	460332
	Placa termostato	NH	460232
	Salida de agua	NB	461532
0147.120	Acople tapa	NB	461533
0230.32	Inspección tapa de cilindros	NB	460334
0127.050	Bastón cierre bancada	GS	460235
1981.020	Arandela pico inyector	AC	560036
	Cierre termostato	GS	550641
	Arandela base inyector A 15 x 21 x 2 C	CU	4
	Arandela A 12 x 18 x 3 C	CU	1
0205.30	Arandela asiento bulón tapa cilindros A 13 x 24 x 5 H	H	
	O'ring G 21.89 x 2.62	GS	1
	O'ring G 17.17 x 1.78	GS	1
	Arandela A 16 x 22 x 1.5 A	AL	1
	Kit de retenes completo		R461500
0956.22	Jgo. retén válvulas (12)	P	R461510P
0127.28	Retén bancada 90 x 110 x7	V	R460211V
0326.22	Retén distribución 42 x 62 x 7	V	R460212V
0236.14	Retén árbol de levas 35 x 50 x 7	V	R470013V

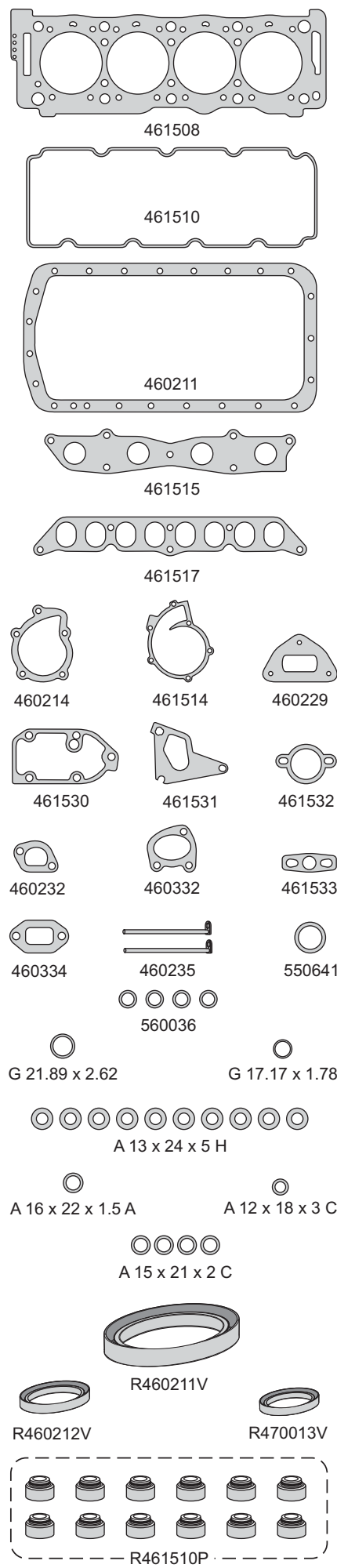

PEUGEOT



Motor/Engine	Cm³	HP	Ø
DJ5 (T9A)	2445	86	92
DJ5T (T8A/THZ)	2445	103	92
DK5ATE Turbo 12V	2445	130	92

Citroën: Jumper D/TD - XM TD - Relay D/TD 1994/97
Peugeot: DJ5 - Boxer D 1994/...
 DJ5T - Boxer TD 1994/97
 DK5ATE - 605 TD 1995/99



DIESEL

Nº OE	Descripción/Description	Mat.	Ref.
	Jgo. de juntas para motor		470000-R
0209.R3	Jgo. de juntas superior	●	470095
	Jta. tapa cilindros Ø 93 \pm 1.60	NFT	470007
	Jgo. tornillos tapa cilindros (HAE14038)		B470000
	Sellador líquido - caucho de silicona		TRN0280R
0249.79	Junta tapa válvulas	N	470010
	Tapa bomba de agua	NFT	470014
0349.E7	Múltiple escape	AC	470015
0348.K1	Múltiple admisión	CB	470017
	Entre múltiple admisión	CB	470031
	Placa termostato	NH	460232
	Lateral cuerpo bomba de agua	NFT	470033
	Acople bomba de agua	NFT	470034
	Junta	CB	470035
	Acople bomba de agua	NFT	470036
1981.020	Arandelas parallamas pico inyector	AC	560036
46340	O'ring entrada depresora G 44 x 2	GS	460340
46341	O'ring salida depresora G 16 x 2	GS	460341
	Arandela A 6 x 11 x 2 C	CU	
	Arandela A 15 x 21 x 2 A	AL	
	Arandela inyector A 17 x 22 x 1.5 C	CU	
	O'ring G 28.3 x 1.78	GS	
	Kit de retenes completo		R470000
	Jgo. retén válvulas (12)	V	R470010V
	Retén bancada 98 x 120 x 7	V	R470011V
	Retén distribución 64 x 88 x 6	V	R470012V
0236.15	Retén árbol levas 35 x 50 x 7	V	R470013V
	Retén árbol levas trasero 40 x 62 x 7	V	R470014V
	Retén auxiliar trasero 47.5 x 62 x 7	V	R470015V

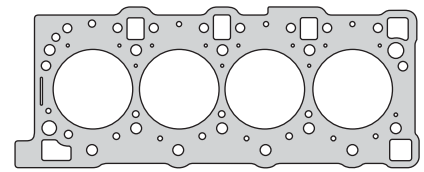

470007

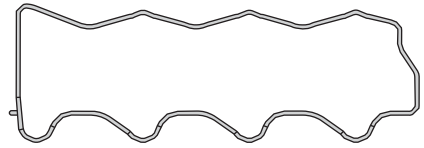

470010



470015



470017



470031

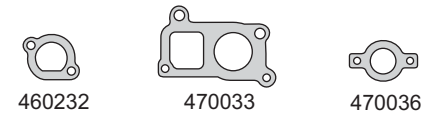

460232

470033

470036



470014

470034

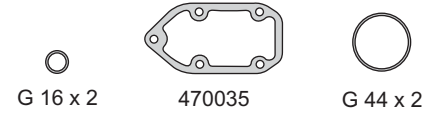

G 16 x 2

470035

G 44 x 2



A 17 x 22 x 1.5 C



G 28.3 x 1.78



A 15 x 21 x 2 A

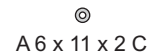

A 6 x 11 x 2 C



R470012V



R470011V



R470013V



R470014V



R470015V

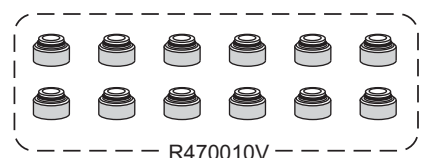

R470010V

PEUGEOT



Motor/Engine	Cm³	HP	Ø
XU10J4	1998	152/155	86
XU10J4TE	1998	200	86
16V			

Citroën: ZX 1992/97 - Xantia 1993/95
Peugeot: 405 MI - 405 TI Turbo 1992/95
 306 1993/...



Nº OE	Descripción/Description	Mat.	Ref.
	Jgo. de juntas para motor		● 470200-R
0209.110	Junta tapa de cilindros Ø 87 ± 1.40	NFT	1 470207
0204.AO	Jgo. tornillos tapa cilin. (HAT55055/HAT55100)		B470200
0249.74	Junta tapa de válvulas	GS	1 451410
0304.34	Junta para cárter	NB	1 460211
1307.46	Bomba de agua	NB	1 460214
0349.98	Múltiple escape	NFT	1 470215
0348.88	Múltiple admisión	NH	1 471017
1798.680	Anillo salida de escape	NFT	1 470218
0365.260	Anillo caja mariposa admisión	GS	1 460430
2101.618181	Placa termostato	NH	1 460232
2108.1107990	Bastón cierre bancada	GS	2 460235
1339.83	Distribución agua	GS	1 470637
1340.48	O'ring termostato G 51.57 x 4.5	GS	1 460245
2101.130300	Arandela B 14 x 20 x 2.5 CN	CN	1
2105.1005255	Arandela A 12 x 18 x 3 C	CU	1
2101.1307048	Arandela B 16 x 22 x 2.5 CN	CN	1
2101.1011021	Arandela A 15 x 20 x 1 C	CU	1
2101.1106170	O'ring G 4.47 x 1.78	GS	5
2101.100608	Arandela A 8 x 12 x 1 C	CU	1
	Arandela A 18 x 23 x 1 C	CU	1
	Kit de retenes completo		R470200
0956.34	Jgo. retén válvulas (16)	V	1 R470110V
0127.80	Retén bancada 90 x 110 x 7	V	1 R460211V
0326.12	Retén distribución 42 x 62 x 7	V	1 R460212V
0236.21	Retén árbol de levas 36 x 50 x 8	V	2 R460213V

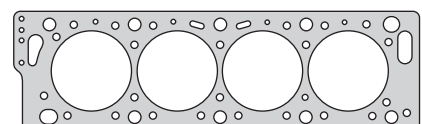

470207

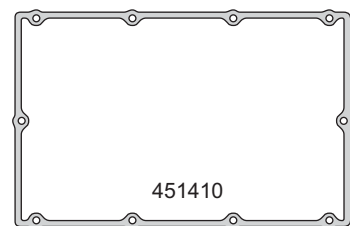

451410

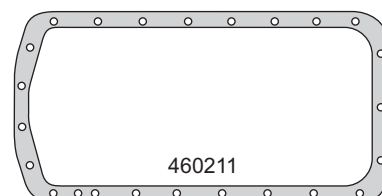

460211

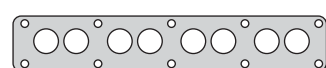

470215



471017



460214



470218



460430



460232



460235



470637

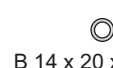

B 14 x 20 x 2.5 CN



B 16 x 22 x 2.5 CN



G 4.47 x 1.78



A 12 x 18 x 3 C



A 18 x 23 x 1 C



A 15 x 20 x 1 C

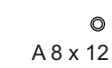

A 8 x 12 x 1 C



G 51.57 x 4.5



R460211V



R460212V



R460213V

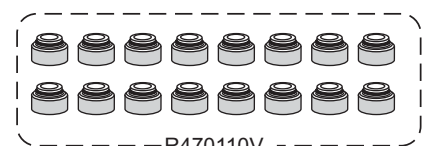

R470110V

PEUGEOT



Motor/Engine	Cm³	HP	Ø
TUD5 (VJY)	1527	55/58	77
TUD5 (VJZ)	1527	55/58	77

Citroën: AX 15 1994/97 - Saxo 1996/...
Peugeot: 106 1994/...
Nissan: Micra 1997/...
Rover: 115TD 1995/98

DIESEL



Nº OE	Descripción/Description	Mat.	Ref.
	Jgo. de juntas para motor		470300-R
0209.T8	Junta tapa cilindros Ø 78 \pm 1.80	NFT 1	470307
0209.T8	Junta tapa cilindros Ø 78 \pm 1.60	MLS	470308
0204.85	Jgo. tornillos tapa cilindros (HAE14038)		B470300
0249.93	Junta tapa de válvulas	N 1	470310
	Junta para cárter	NB 1	451611
0304.304	Junta para cárter	NB 1	460711
0349.E4	Múltiple escape	AC 1	470315
1.709.10	Salida de escape	AC 1	470318
133.986	Termostato	GS 1	240419
	Arandela A 7 x 12 x 2 H	H	470340
1981.020	Arandela inyector parallamas	AC 4	560036
198.133	Arandela inyector A 17 x 20 x 1.5 C	CU 4	
	Arandela A 10 x 18 x 2 A	AL 1	
	Arandela A 12 x 17 x 2 C	CU 4	
	Arandela A 14 x 22 x 2 C	CU 2	
	Arandela A 18 x 23 x 1.25 C	CU 1	
	Arandela A 22 x 29 x 3 A	AL 3	
	Arandela A 7 x 13 x 1.5 A	AL 8	
	Arandela A 14 x 18 x 1.5 A	AL 1	
	O´ring G 37.77 x 2.62	GS 1	
	O´ring G 47.35 x 1.78	GS 1	
120.696	O´ring G 74 x 3	GS 1	
	O´ring G 8 x 2.4	GS 1	
	Kit de retenes completo		R470300
0956.19	Jgo. retén válvulas (8)	V 1	R460710V
0514.74	Retén bancada 85 x 105 x 8	V 1	R560111V
0514.72	Retén distribución 42 x 66 x 8	V 1	R460712V
0236.44	Retén árbol de levas 36 x 50 x 8	V 1	R460213V

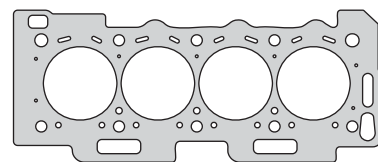

470307

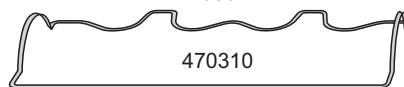

470310

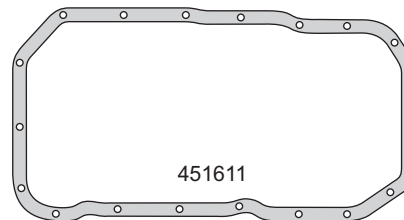

451611

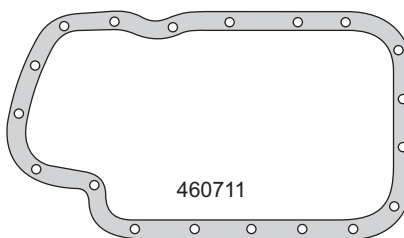

460711



470315



470318

560036



240419



A 22 x 29 x 3 A



A 14 x 22 x 2 C



A 12 x 17 x 2 C



A 17 x 20 x 1.5 C



A 10 x 18 x 2 A



A 18 x 23 x 1.25 C



A 14 x 18 x 1.5 A



A 7 x 13 x 1.5 A



G 8 x 2.4



A 7 x 12 x 2 H



G 47.35 x 1.78



G 37.77 x 2.62



G 74 x 3



R560111V



R460712V



R460213V

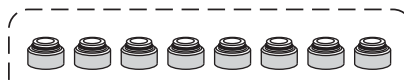

R460710V

PEUGEOT



Motor/Engine	Cm³	HP	Ø
TUD3	1360	52	75
TUD3 (K9A)	1360	50	75

Citroën: AX 14 1988/94
Peugeot: 106 1992/95

DIESEL



Nº OE	Descripción/Description	Mat.	Ref.
	Jgo. de juntas para motor		470400-R
0209.E9	Junta tapa de cilindros Ø 76 \pm 1.80	NFT	1 470407
0209.N4	Junta tapa de cilindros Ø 76 \pm 1.70	MLS	470408
	Jgo. tornillos tapa cilindros (HAE14038)		B470400
0249.76	Junta tapa de válvulas	S	1 470410
0304.304	Junta para cárter	NB	1 460711
0349.E4	Múltiple escape	AC	1 470315
1.709.10	Salida de escape	AC	1 470318
133.986	Termostato	GS	1 240419
1981.020	Arandela parallamas pico inyector	AC	4 560036
	Guarnición termostato	GS	460245
7701348178	Jgo. suplemento camisas cilindros (4)	S	1 550671
	Arandela inyector A 16 x 22 x 2 C	CU	4
	Arandela A 14 x 18 x 1.5 A	AL	8
	Arandela A 16 x 22 x 1.5 A	AL	1
	Arandela A 22 x 29 x 3 A	AL	2
	Arandela A 16 x 24 x 1.5 A	AL	1
	Arandela A 12 x 18 x 1.5 C	CU	1
	Arandela A 12 x 17 x 2 C	CU	2
	Arandela A 11 x 18 x 2 C	CU	2
	Arandela A 6 x 11 x 2 C	CU	1
120.694	O'ring bomba de agua G 56.82 x 2.62	GS	1
593.360	O'ring derivación de agua G 36.5 x 3.2	GS	1
120.696	O'ring acople de agua G 74 x 3	GS	1
	O'ring derivación de agua t/cil. G 45.69 x 2.62	GS	1
	Kit de retenes completo		R470400
0956.19	Jgo. retén válvulas (8)	V	1 R460710V
0514.74	Retén bancada 85 x 105 x 12	V	1 R220411V
0514.72	Retén distribución 42 x 66 x 8	V	1 R460712V
0236.44	Retén árbol de levas 36 x 50 x 8	V	1 R460213V

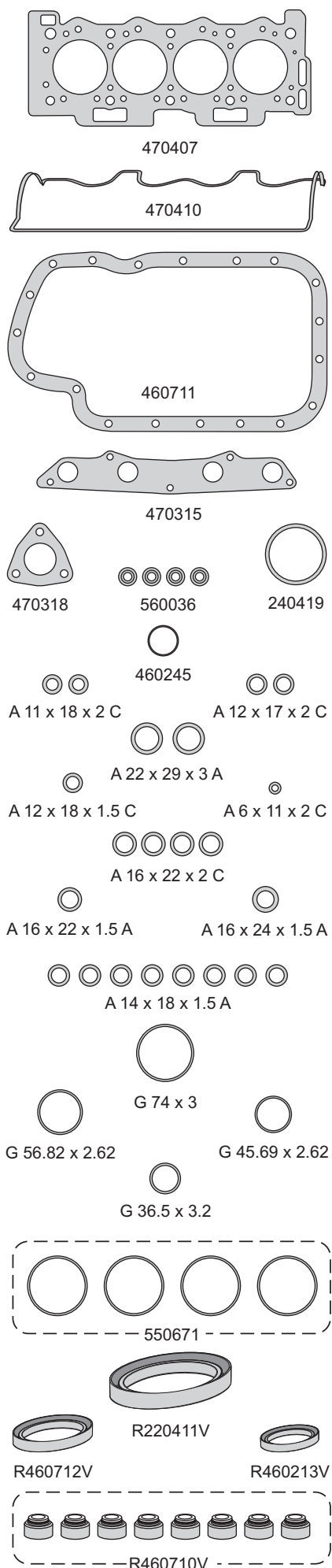

PEUGEOT



Motor/Engine	Cm³	HP	Ø
TU5JP/J2	1587	90/103	78.5

Citroën: ZX - Saxo 1996/... - Xsara 1997/...
Peugeot: 106 1994/... - 306 1993/... - 206 1998/...



Nº OE	Descripción/Description	Mat.	Ref.
	Jgo. de juntas para motor		470501-R
	Jgo. de juntas superior	●	470595
0209.W8	Junta tapa cilindros Ø81.5 \pm 1.40	MLS	470508-1.40
0209.W9	Junta tapa cilindros Ø81.5 \pm 1.60	MLS	470508-1.60
	Jgo. tornillos tapa cilindros (HAE14038)		B470500
	Conj. junta tapa válvulas (3)	GS 1 1	460710
	Junta para cárter	NB 1 1	451611
	Jgo. múltiple escape (2)	AC 1 1	451615
	Jgo. múltiple admisión (4)	GS 1 1	451617
	Salida de escape	NFT 1 1	460718
	Arandela tapa válvulas	NH 2 2	451732
	Guarnición termostato	GS 1 1	460245
	Junta base carburador	NB 2 2	06053
	O´ring G 36.17 x 2.62	GS 1 1	
	O´ring G 75.87 x 2.62	GS	1
	Arandela A 12 x 18 x 1.5 A	AL 1 1	
	Arandela A 22 x 30 x 2 C	CU	3
	Arandela A 17 x 22 x 1.5 C	CU	2
	Kit de retenes completo		R470500
	Jgo. retén válvulas (8)	V 1	R460710V
0514.74	Retén bancada 85 x 105 x 8	V 1	R560111V
0514.72	Retén distribución 42 x 66 x 8	V 1	R460712V
0236.44	Retén árbol de levas 36 x 50 x 8	V 2	R460213V

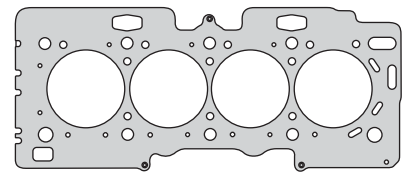

470508

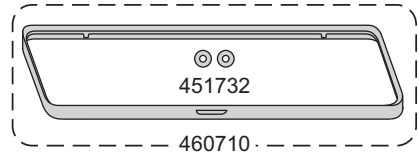

451732

460710

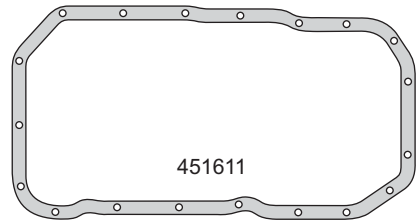

451611

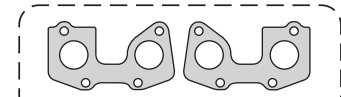

451615



451617

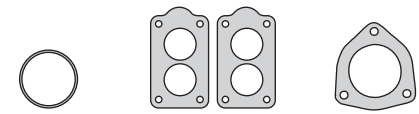

460245

06053

460718

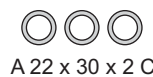

A 22 x 30 x 2 C



G 36.17 x 2.62

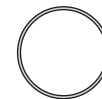

G 75.87 x 2.62



A 17 x 22 x 1.5 C



A 12 x 18 x 1.5 A



R560111V



R460712V



R460213V



R460710V

PEUGEOT



Motor/Engine	Cm³	HP	Ø
DW8 (WJZ/WJY)	1868	71	82.2

Citroën: Berlingo - Jumpy - Xsara 1998/...
C5 - Xsara - Jumpy 2000/...
Peugeot: 206 - 306 1998/...
Expert - Partner 1999/...

DIESEL



Nº OE	Descripción/Description	Mat.	1	2	Ref.
0197.X6	Jgo. de juntas para motor			●	470601-R
	Jgo. de juntas superior		●		470695-1M
	Jgo. de juntas superior				470695-2M
	Jgo. de juntas superior				470695-3M
	Jgo. de juntas superior				470695-4M
	Jgo. de juntas superior				470695-5M
	Jgo. de juntas superior (MLS)				470695-1M MLS
	Jgo. de juntas superior (MLS)				470695-2M MLS
	Jgo. de juntas superior (MLS)				470695-3M MLS
	Jgo. de juntas superior (MLS)				470695-4M MLS
	Jgo. de juntas superior (MLS)				470695-5M MLS
	Junta tapa cilindros Ø 84 \times 1.26	NFT	1		470607-1M
	Junta tapa cilindros Ø 84 \times 1.30	NFT			470607-2M
	Junta tapa cilindros Ø 84 \times 1.34	NFT			470607-3M
	Junta tapa cilindros Ø 84 \times 1.38	NFT			470607-4M
	Junta tapa cilindros Ø 84 \times 1.42	NFT			470607-5M
0209.X0	Junta tapa cilindros Ø 84 \times 1.26	MLS			470608-1M
0209.X1	Junta tapa cilindros Ø 84 \times 1.30	MLS			470608-2M
0209.X2	Junta tapa cilindros Ø 84 \times 1.34	MLS			470608-3M
0209.X3	Junta tapa cilindros Ø 84 \times 1.38	MLS			470608-4M
0209.X4	Junta tapa cilindros Ø 84 \times 1.42	MLS			470608-5M
	Jgo. tornillos tapa cilindros (HAE14038)				B470600
0249.95	Junta tapa válvulas	N	1	1	470610
	Junta tapa válvulas reforma 2005/...	N			470633
0249.97	Junta sobretapa de válvulas	N	1	1	470636
0304.34	Junta para cárter	NB	1		460211
1206.460	Tapa bomba de agua	NB	1		460214
0349.H7	Jgo. múltiple escape (2)	AC	1	1	470615
0348.N8/P0	Jgo. múltiple admisión (3)	NB	1	1	470617
	Anillo termostato	GS	1		240419
0164.300	Junta alojamiento termostato	CG	1		460229
0147.120	Placa termostato	NH	1		460232
0127.050	Bastón cierre bancada	GS	2		460235
1981.020	Arandela pico inyector	AC			560036
1339.83	Guarnición distribuidora de agua	GS	1		470637
	Arandela con inserto metálico A 19 x 30 x 3 H	H			470638
	Guarnición termostato	GS	1		460245
	Arandela inyector A 17 x 20 x 1.5 C	CU	4	4	
	Arandela A 22 x 28 x 2 A	AL		1	
020513	Arandela A 13 x 24 x 3 H	H			
	Kit de retenes completo				R460300
	Jgo. retén válvulas (8)	V	1		R460210V
0127.28	Retén bancada 90 x 110 x 7	V	1		R460211V
0326.22	Retén distribución 42 x 62 x 7	V	1		R460212V
0236.15	Retén árbol de levas 35 x 50 x 7	V	1		R470013V

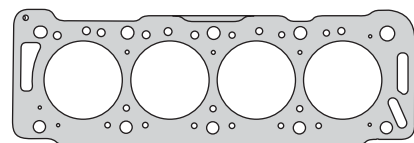

470608



470610



470633



470636

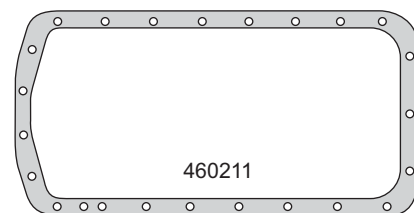

460211

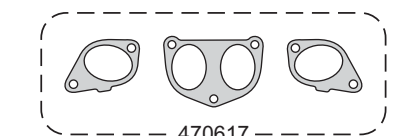

470617

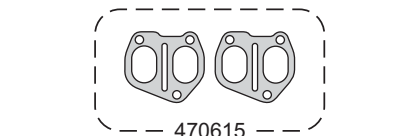

470615



460214



240419

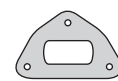

460229



460232



460235



470637



460245



A 19 x 30 x 3 H



A 17 x 20 x 1.5 C



A 13 x 24 x 3 H



A 22 x 28 x 2 A



R460211V



R460212V



R470013V



R460210V

PEUGEOT



Motor/Engine	Cm³	HP	Ø
XUD7T/TE	1769	78/90	80

Citroën: BX 17 TD 1988/92
Peugeot: 205 TD 1990/96 - 405 TD 1988/94
 309 TD 1990/93
Rover: 218 TD - 418 TD 1991/96
 Tourer TD 1996/...

DIESEL



Nº OE	Descripción/Description	Mat.	Ref.
	Jgo. juntas para motor		460301-R
0209.90	Junta tapa cilindros Ø 82 ± 1.65	NFT	470707-2M
0209.91	Junta tapa cilindros Ø 82 ± 1.80	NFT	470707-3M
	Jgo. tornillos tapa cilin. (HAT55055/HAT55100)		B470700
0.249.910	Conj. junta tapa válvulas (4)	N	460310
0.304.340	Junta para cárter	NB	460211
1.206.460	Bomba de agua	NB	460214
0349.780	Jgo. múltiple escape (2)	NFT	460316
0348.98/99	Jgo. múltiple admisión (3)	NB	470917
0348.N8/P0	Jgo. múltiple admisión (3)	NB	470617
0348.JO	Múltiple admisión y escape turbo	NFT	460317
1.710.99	Salida de escape	AC	460318
1339.730	Cuerpo termostato	NB	460319
	Arandela B 16 x 22 x 2.4 CN	CN	450229
0.164.300	Junta alojamiento termostato	CG	460229
0.147.140	Porta retén frente motor	CB	460329
0.147.120	Placa termostato	NH	460232
1.339.620	Base termostato	NB	460332
1.339.410	Inspección	NB	460333
0.236.320	Inspección bomba trasera	NB	460334
0.197.050	Bastón bancada	GS	460235
1981.020	Arandela pico inyector parallamas	AC	560036
7703061078	Arandela base inyector A 16 x 21 x 2 C	CU	500240
0.455605	O´ring entrada depresora G 44 x 2	GS	460340
0.455606	O´ring salida depresora G 16 x 2	GS	460341
	Cierre termostato	GS	550641
	O´ring G 18.72 x 2.62	GS	1
	O´ring G 29.87 x 1.78	GS	1
	O´ring G 37 x 4	GS	4
	Arandela A 6 x 11 x 2 C	CU	2
	Arandela A 7 x 14 x 1 H	H	4
	Arandela A 14 x 17.2 x 2 C	CU	2
1.981.050	Arandela A 12 x 18 x 3 A	AL	1
0.164.300	Arandela A 22 x 29 x 1.5 A	AL	1
0.127.050	Arandela tapa válvula A 7 x 17 x 1.5 FA	NB	3
	Arandela A 16 x 21 x 1.5 C	CU	2
	Arandela A 16 x 22 x 1.5 A	AL	3
	Kit de retenes completo		R460300
0.119.060	Jgo. retén válvulas (8)	V	R460210V
0326.220	Retén bancada 90 x 110 x 7	V	R460211V
0514.150	Retén distribución 42 x 62 x 7	V	R460212V
0.236.44	Retén árbol de levas 35 x 50 x 7	V	R470013V

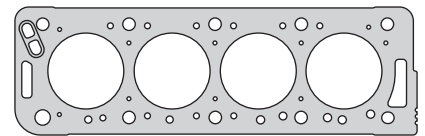

470707

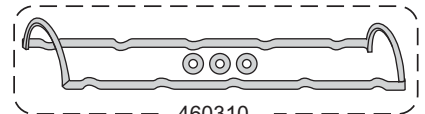

460310

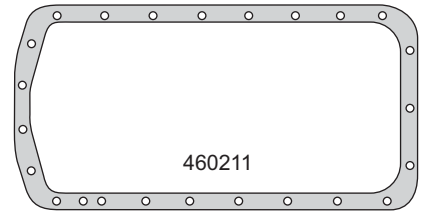

460211

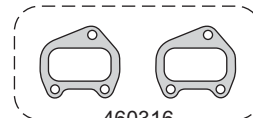

460316



460317

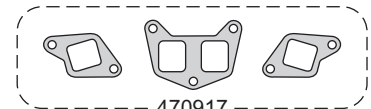

470917

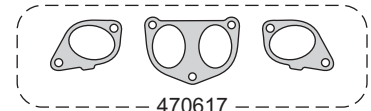

470617

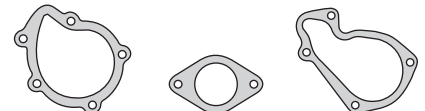

460214

460318

460319



460229

460329

460332



460333

460232

460235

460334



560036

G 44 x 2

G 16 x 2

550641

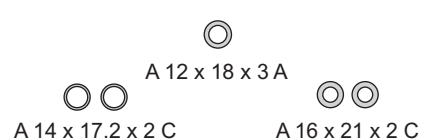

A 12 x 18 x 3 A

A 14 x 17.2 x 2 C

A 16 x 21 x 2 C



A 16 x 22 x 1.5 A

A 7 x 14 x 1 H



R460212V

R460211V

R470013V



R460210V

PEUGEOT



Motor/Engine	Cm³	HP	Ø
DW10TD/ATED (RHV/RHX/RHS RHZ/RHY)	1997	90/110	85

Citroën: Xantia - Jumper - Xsara HDI 1998/...
Berlingo - Evasion - Xsara Picasso HDI
Dispatch HDI - Jumper HDI 1999/...

Peugeot: 306/406 HDI 1998/... - 206/806 HDI
Boxer HDI - Expert HDI - Partner

Suzuki: Vitara - Grand Vitara HDI
2000/...



DIESEL

Nº OE	Descripción/Description	Mat.	Ref.
	Jgo. de juntas para motor		470801-R
0209.X5	Junta tapa de cilindros Ø 86 \pm 1.30	NFT	470807-1M
0209.X6	Junta tapa de cilindros Ø 86 \pm 1.35	NFT	470807-2M
0209.X7	Junta tapa de cilindros Ø 86 \pm 1.40	NFT	470807-3M
0209.X8	Junta tapa de cilindros Ø 86 \pm 1.45	NFT	470807-4M
0209.X9	Junta tapa de cilindros Ø 86 \pm 1.50	NFT	470807-5M
0209.X5	Junta tapa de cilindros Ø 86 \pm 1.30	MLS	470808-1M
0209.X6	Junta tapa de cilindros Ø 86 \pm 1.34	MLS	470808-2M
0209.X7	Junta tapa de cilindros Ø 86 \pm 1.38	MLS	470808-3M
0209.X8	Junta tapa de cilindros Ø 86 \pm 1.42	MLS	470808-4M
0209.X9	Junta tapa de cilindros Ø 86 \pm 1.50	MLS	470808-5M
0204.900	Jgo. tornillos tapa cilindros (HAE14038)		B470800
0249.99	Junta tapa de válvulas	N	1 470810
0304.34	Junta para cárter	NB	1 470811
1.206.460	Bomba de agua	NB	1 460214
0349.H4	Múltiple escape	AC	1 470815
0348W4	Múltiple admisión	NB	1 470817
1340.48	Guarnición termostato	GS	1 450519
	Soporte distr. de agua trasero y termostato	SLS	1 470819
0127.050	Bastón cierre bancada	GS	2 460235
1339.83	Guarnición agua	GS	1 470637
	Arandela tapón cárter B 14 x 18 x 2 CN	CN	150034
1981.43	Arandela inyector A 7 x 15 x 1.5 C	CU	4 470840
	Salida de escape	AC	1 470862
	Arandela A 18 x 23 x 1 C	CU	1
	Arandela A 12 x 18 x 2 C	CU	1
	Arandela A 14 x 18 x 1.5 A	AL	1
	Kit de retenes completo		R470800
0956.48	Jgo. retén válvulas (8)	V	1 R470810V
0127.28	Retén bancada 90 x 110 x 7	V	1 R460211V
0326.22	Retén distribución 42 x 62 x 7	V	1 R460212V
0807.28	Retén árbol de levas 27 x 47 x 7	V	1 R470813V

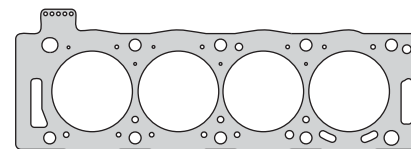

470807



470810

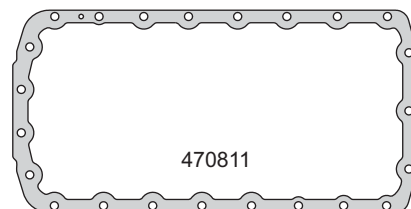

470811



470815

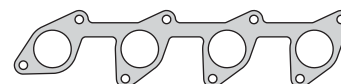

470817

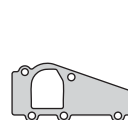

470819



460214



450519



470637



460235



470862



A 14 x 18 x 1.5 A



A 18 x 23 x 1 C



A 12 x 18 x 2 C



A 7 x 15 x 1.5 C



R460211V



R460212V



R470813V



R470810V

PEUGEOT



Motor/Engine	Cm³	HP	Ø
XUD7 (161A/A9A)	1769	60	80

Citroën: C15 1994/... - Berlingo 1996/99
Xsara 1997/... - ZX 1991/94
Peugeot: 205 - 309 1983/96 - 306 1993/...
Partner 1996/...

DIESEL



Nº OE	Descripción/Description	Mat.	Ref.
	Jgo. de juntas para motor		460301-R
0.209.S0	Junta tapa de cilindros Ø 82 \pm 1.36	NFT	470907-1M
0.209.S1	Junta tapa de cilindros Ø 82 \pm 1.40	NFT	470907-2M
0.209.S2	Junta tapa de cilindros Ø 82 \pm 1.44	NFT	470907-3M
0.209.S3	Junta tapa de cilindros Ø 82 \pm 1.48	NFT	470907-4M
0.209.S4	Junta tapa de cilindros Ø 82 \pm 1.52	NFT	470907-5M
0.209.S5	Junta tapa de cilindros Ø 82 \pm 1.80	NFT	470907-6M
0.204.65	Jgo. tornillos tapa cilin. (HAT55055/HAT55100)		B460300
0.249.910	Conj. junta tapa válvulas (3)	N	460310
0.304.340	Junta para cárter	NB	460211
1.206.440	Tapa bomba de agua	NB	460214
0.349.780	Jgo. múltiple escape (2)	NFT	460316
0.348.J0	Jgo. múltiple admisión y escape	NFT	460317
0.365.340	Jgo. entre colec. adm. aspirado G 37 x 4 (4)	GS	460917
0.348.N8/P0	Jgo. múltiple admisión aspirado (3)	NB	470617
0.348.980/90	Jgo. múltiple admisión (3)	NB	470917
1.710.990	Salida de escape	AC	460318
1.339.730	Cuerpo termostato	NB	460319
	Arandela tapón cárter B 16 x 22 x 2.4 CN	CN	450229
0.236.320	Junta porta varilla a nivel aceite	CG	460229
0.147.140	Porta retén frente motor	CB	460329
	Arandela tapa válvulas A 7 x 17 x 1.5 FA	NB	550430
0.147.120	Placa termostato	NH	460232
1.339.620	Base termostato	NB	460332
0.230.320	Inspección bomba aceite	NB	460334
1.451.160	Inspección bomba aceite	NB	460333
0.127.050	Bastón cierre bancada	GS	460235
	Arandela A 22 x 29 x 1.5 A	AL	460336
	Arandela inyector A 16 x 21 x 2 C	CU	500240
	Cierre termostato	GS	550641
455.606	Bomba depresora G 44 x 2	GS	460340
455.605	O´ring bomba depresora salida G 16 x 2	GS	460341
1981.020	Arandela parallamas pico inyector	AC	560036
	Arandela A 12 x 18 x 3 A	AL	
	Arandela A 6 x 11 x 2 C	CU	
	Arandela A 14 x 17.2 x 2 C	CU	
	Arandela A 7 x 14 x 1 H	H	
	Arandela A 16 x 21 x 1.5 C	CU	
	Arandela A 16 x 22 x 1.5 A	AL	
	O´ring G 18.72 x 6.62	GS	
	O´ring G 29.87 x 1.78	GS	
	Kit de retenes completo		R460300
0.956.22	Jgo. retén válvulas (8)	V	R460210V
0127.28	Retén bancada 90 x 110 x 7	V	R460211V
0326.22	Retén distribución 42 x 62 x 7	V	R460212V
0236.44	Retén árbol de levas 35 x 50 x 7	V	R470013V

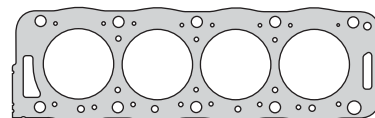

470907

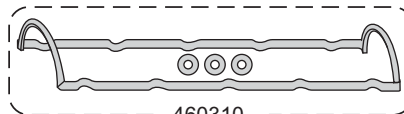

460310

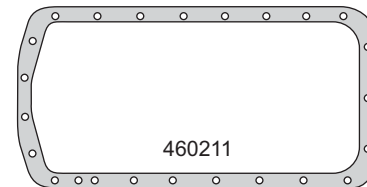

460211

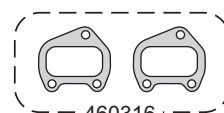

460316



460317



460917



470617

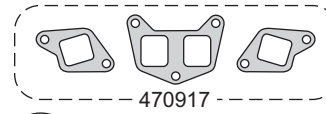

470917



460214

460318

460319

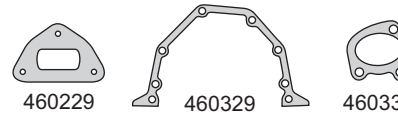

460229

460329

460332

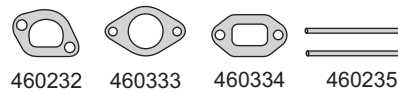

460232

460333

460334

460235



560036

G 44 x 2

G 16 x 2

550641



A 14 x 17.2 x 2 C

A 12 x 18 x 3 A

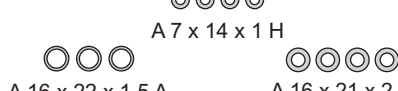

A 16 x 22 x 1.5 A

A 16 x 21 x 2 C

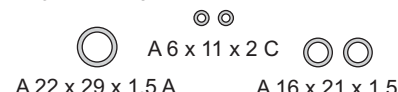

A 22 x 29 x 1.5 A

A 6 x 11 x 2 C

A 16 x 21 x 1.5 C



R460212V

R460211V

R470013V

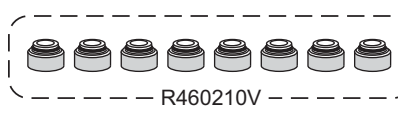

R460210V

PEUGEOT



Motor/Engine	Cm³	HP	Ø
XU10J4R	1998	132/135	86
XU10J4R (RFV)	1998	132/135	86

Citroën: Xantia 1995/2001 - Xsara 1998/00
Evasion - Synergie 1998/...

Peugeot: 406 - 605 1995/... - 306 1997/...
806 1998/...



Nº OE	Descripción/Description	Mat.	Ref.
	Jgo. de juntas para motor		● 471000-R
0209.N6	Junta tapa de cilindros Ø 87 \pm 1.20	NFT	1 471007
0204.AO	Jgo. tornillos tapa cilindros (HAE14038)		B471000
0249.A2/A3	Conj. juntas tapa válvulas (2)	N	1 460810
0304.34	Junta para cárter	NH	1 460211
13070.46	Bomba de agua	NH	1 460214
0349.HO	Múltiple escape	AC	1 471015
0348.C8	Múltiple admisión	NH	1 460817
0365.260	Anillo caja mariposa admisión	S	1 460430
2101.1018080	Placa termostato	CB	1 460232
2108.1107990	Bastón cierre bancada	GS	2 460235
1339.83	Distribución bomba de agua	GS	1 470637
1340.48	O'ring termostato	GS	1 460245
0348.K6	Jgo. múltiple admisión (5) 1997/...	S	1 460841
	Múltiple admisión mariposa	S	1 460842
2101.1303020	Arandela A 14 x 18 x 1.5 A	AL	1
2101.1307048	Arandela A 16 x 22 x 1.5 C	CN	
2105.1005255	Arandela A 12 x 18 x 3 C	CU	1
2101.1011021	Arandela A 15 x 20 x 1 C	CU	1
	Arandela A 18 x 23 x 1 A	AL	1
2101.1186170	O'ring G 4.47 x 1.78	GS	5
2101.100608	Arandela A 8 x 12 x 1 C	CU	1
	Kit de retenes completo		R460800
0956.420	Jgo. retén válvulas (16)	V	1 R460810V
0127.28	Retén bancada 90 x 110 x 7	V	1 R460211V
0326.22	Retén distribución 42 x 62 x 7	V	1 R460212V
0236.44	Retén árbol de levas 36 x 50 x 8	V	2 R460213V

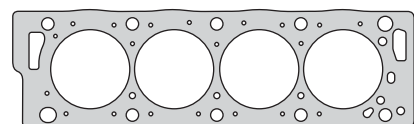

471007

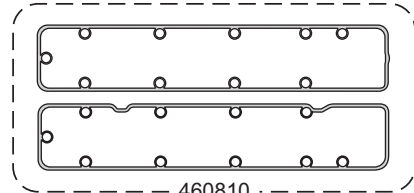

460810

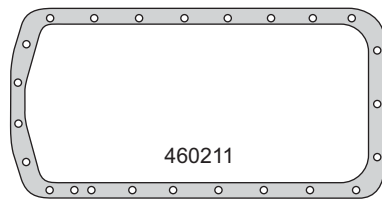

460211

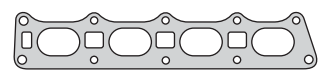

471015

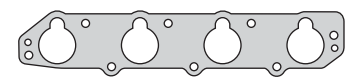

460817



460841

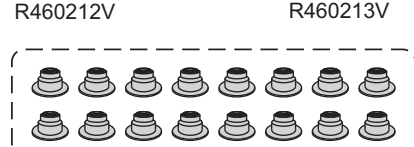
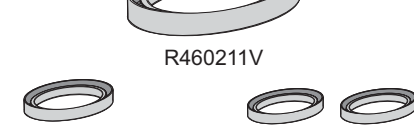
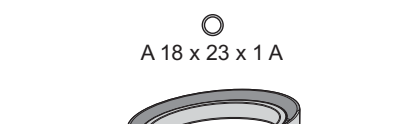
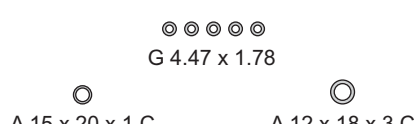
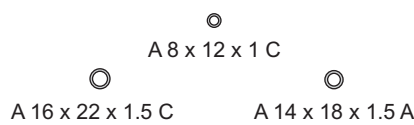
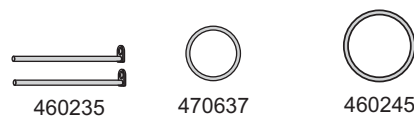

PEUGEOT



Motor/Engine	Cm³	HP	Ø
EW10J4 (RFN-RLZ)	1997	136/140	85

Citroën: Jumpy - Dispatch - Xsara - Evasion
1998/... - C5 - C5 HPI 2001/...
C8 2002/... - C4 2004/...

Peugeot: 206 - 307 - 406 - 806 - 807 - Expert
2000/... - 406 HPIV - 607 2001/...
407 2004/...



Nº OE	Descripción/Description	Mat.	Ref.
0197.Y1	Jgo. de juntas para motor		471200-R MLS
	Jgo. de juntas superior (MLS)		471295 MLS
	Junta tapa cilindros Ø 86 ± 1.20		471207
0209.Z3	Junta tapa cilindros Ø 85.5 ± 0.65	MLS 1 1	471208
0204.A7	Jgo. tornillos tapa cilindros (HAE14038)		B471200
	Sellador líquido - caucho de silicona		TRN0280R
0249.A5/A4	Jgo. juntas tapa válvulas (2)	GS 1 1	471210
0349.H8	Múltiple escape	AC 1 1	471215
0348.P1	Jgo. múltiple admisión (5)	NFT 1 1	471217
1340.60	Guarnición termostato	GS 1	471219
	Junta soporte filtro aceite	NB 1	471227
	Junta base soporte filtro aceite	NB 1	471230
	Arandela con inserto A 22 x 32 x 1.5 A	AL 2	471231
	Junta canalizador agua	NB 1	471232
	Jgo. múltiple admisión (4)	GS 1 1	471235
	Arandela A 16 x 22 x 1.5 A	AL 1	
	Arandela A 14 x 20 x 1.5 C	CU 1	
	Guarnición G 45 x 49 x 5	GS 1	
	Arandela A 6 x 10.5 x 2 C	CU 1	
	O'ring G 48.9 x 2.62	GS 1	
	O'ring G 31.47 x 1.78	GS 1	
	Kit de retenes completo		R471200
0956.45	Jgo. retén válvulas (16)	V 1	R460810V
0127.28	Retén bancada 90 x 110 x 7	V 1	R460211V
0326.27	Retén distribución 40 x 55 x 7	V 1	R270713V
0236.44	Retén árbol levas 36 x 50 x 8	V 2	R460213V
0.807.240	Retén auxiliar 38 x 50 x 6	V 1	R452113V

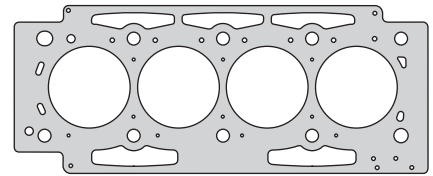

471208

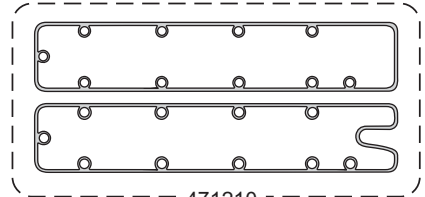

471210

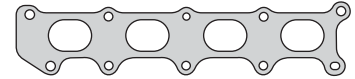

471215

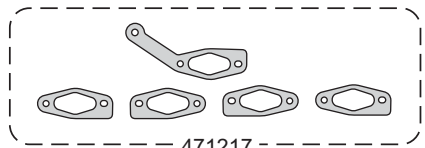

471217



471235



471219

471227

471230

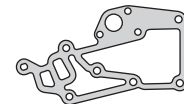

471232

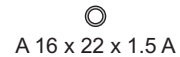

A 16 x 22 x 1.5 A



G 48.9 x 2.62



G 45 x 49 x 5



A 22 x 32 x 1.5 A



G 31.47 x 1.78



A 6 x 10.5 x 2 C

A 14 x 20 x 1.5 C



R460211V



R452113V



R460213V



R270713V

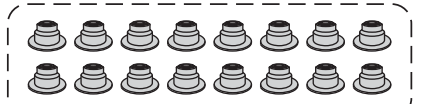

R460810V

PEUGEOT



Motor/Engine	Cm³	HP	Ø
DV6TED4	1398	70	75
DV6TED4	1560	109	75
DV6TED4(9HY/Z)	1560	104/108	75
G8DA (DOHC) 16V			

Citroën: Xsara - Picasso TD 1999/...
C4/C5 TD 2004/...

Ford: Focus C-Max TDCI 2003/...
Fusion TDCI 2004/...

Peugeot: 307 HDI - 407 TD 2004/...
207 Compact



DIESEL

Nº OE	Descripción/Description	Mat.	Ref.
	Jgo. de juntas para motor		471301-R
	Jgo. de juntas superior		471395
0209.CA	Junta tapa cilindros Ø 76 \pm 1.20	NFT	471307-1M
0209.CC	Junta tapa cilindros Ø 76 \pm 1.30	NFT	471307-2M
0209.CE	Junta tapa cilindros Ø 76 \pm 1.40	NFT	471307-3M
0209.CF	Junta tapa cilindros Ø 76 \pm 1.45	NFT	471307-4M
0209.CG	Junta tapa cilindros Ø 76 \pm 1.50	NFT	471307-5M
0209.CA	Junta tapa cilindros Ø 76 \pm 1.25	MLS	471308-1M
0209.CC	Junta tapa cilindros Ø 76 \pm 1.30	MLS	471308-2M
0209.CE	Junta tapa cilindros Ø 76 \pm 1.35	MLS	471308-3M
0209.CF	Junta tapa cilindros Ø 76 \pm 1.40	MLS	471308-4M
0209.CG	Junta tapa cilindros Ø 76 \pm 1.45	MLS	471308-5M
0204.C5	Jgo. tornillos tapa cilindros (HAE14038)		B302100
0249.C2	Junta tapa válvulas	N	471310
12232358/1	Junta para cárter	NB	302111
01206.E2	Bomba de agua	NB	302114
0349.V8	Múltiple escape	AC	302115
0348.R4	Jgo. múltiple admisión (7)	GS	471317
1336.Y0	Junta frente termostato	GS	471319
1019.30	Guarnición base filtro aceite bomba	GS	581036
1981.55	Arandela asiento inyector A 7 x 15 x 2 C	CU	471329
0348.55	Guarnición entrada admisión	GS	471336
	Junta	GS	581036
1336.X4	O´ring bomba de agua G 36.09 x 3.53	GS	
0313.33	Arandela tapón cárter A 17 x 21 x 1.5 C	CU	
1013.07	Guarnición bomba aceite G 18 x 24 x 3	GS	
	O´ring G 35 x 6	GS	4
	O´ring G 30 x 6	GS	4
	Kit de retenes completo		R471300
0956.51	Jgo. retén válvulas (16)	V	1 R471310V
0514.74	Retén bancada 85 x 105 x 8	V	1 R560111V
0326.22	Retén distribución 40 x 55 x 7	V	1 R270713V
0807.30	Retén árbol de levas 27 x 47 x 7	V	1 R470813V

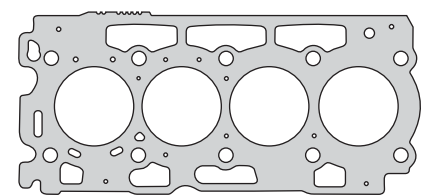

471308

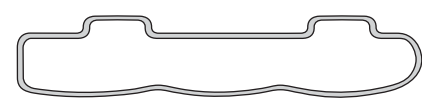

471310

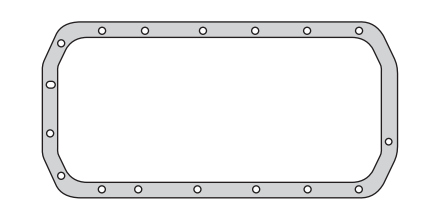

302111

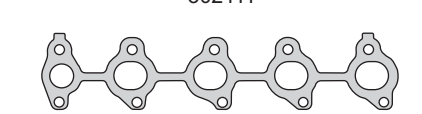

302115

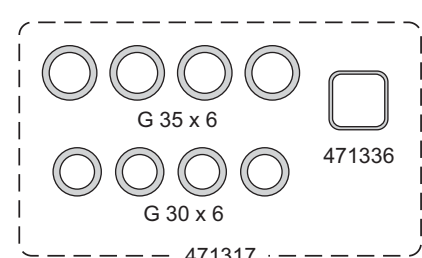

471317

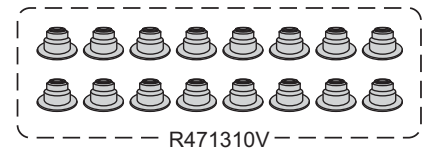
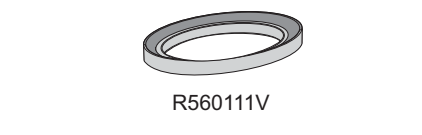
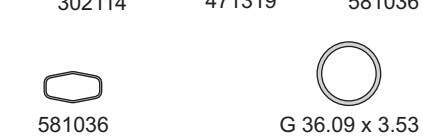
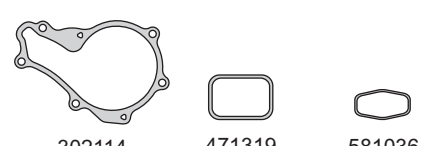

PEUGEOT



Motor/Engine	Cm³	HP	Ø
DW10BTEd4 (RHR/RHK) DURATORQ (20DD0X) (DOHC) 16V	1997	136	85
	1998	110/115 130/140	85

DIESEL

Citroën: C4 - C5 HDI 2004/... - C4 HDI FAP 07/...
C8 - C4 Picasso HDI 2006/...

Ford: C-Max TDCI - Focus TDCI - S-Max TDCI
Galaxy TDCI - Mondeo TDCI 2006/...

Peugeot: 307 HDI FAP 2003/... - 407 HDI 2004/...
Expert HDI - 807 HDI 2006/...



Nº OE	Descripción/Description	Mat.	Ref.
	Jgo. de juntas para motor		471401-R
0209.0S	Junta tapa cilindros Ø 86 \pm 1.25	MLS	471408-1M
0209.0T	Junta tapa cilindros Ø 86 \pm 1.30	MLS	471408-2M
0209.0V	Junta tapa cilindros Ø 86 \pm 1.35	MLS	471408-3M
0209.0W	Junta tapa cilindros Ø 86 \pm 1.40	MLS	471408-4M
0204.A6	Jgo. tornillos tapa cilindros (HAE14038)		B470800
0.348.S3	Conj. tapa de válvulas (5)	GS	471410
0304.34	Junta para cárter	NB	470811
	Bomba de agua	NB	460214
0349.J2	Múltiple admisión y escape	AC	471415
	Jgo. múltiple admisión (4)	GS	451617
1709.28	Salida de escape a turbo	AC	471418
	Guarnición termostato	GS	471419
	Bastón cierre bancada	GS	460235
	Guarnición termostato	GS	460245
0313.27	Arandela tapón cárter A 14 x 21 x 1.5 C	CU	
1981.49	Arandela pico inyector A 7.5 x 15 x 2 C	CU	
	Kit de retenes completo		R471400
0956.48	Jgo. retén válvulas (16)	V	R471410V
0127.45	Retén bancada trasera 90 x 110 x 7	V	R460211V
0127.47	Retén distribución 42 x 62 x 7	V	R460212V
0807.28	Retén árbol de levas 27 x 47 x 7	V	R470813V

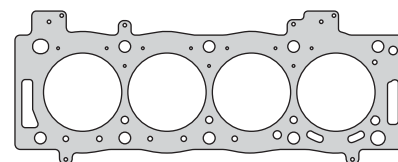

471408

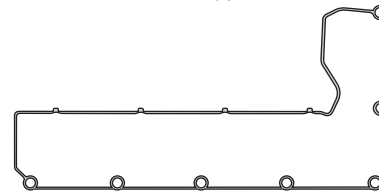

471410

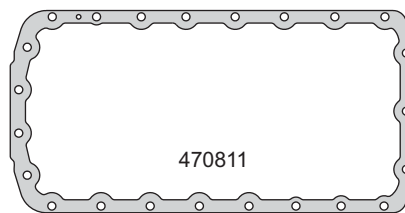

470811

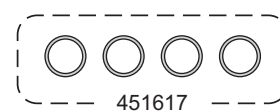

451617



471415



460214



471418



471419



460235



A 7.5 x 15 x 2 C



460245



A 14 x 21 x 1.5 C



R460211V



R460212V



R470813V

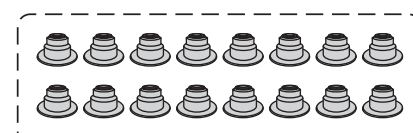

R471410V

PEUGEOT



Motor/Engine	Cm³	HP	Ø
DW10ATED4	1997	109	85
DW10JATED4	1997	110	85
G6DA/G6DC	1998	135	85
DW12TED4 (DOHC)	2179	130/133	85

Citroën: Evasion HDI 2000/... - C5/8 HDI 2001/... - C8 - Jumpy HDI 2002/...
Ford: Focus C-Max TDCI 2003/...
Lancia: Phedra JTD - Zeta JTD 2000/..., 2002/...
Peugeot: 806 - Expert HDI 1999/... 406/607/807 HDI 2000/...



DIESEL

Nº OE	Descripción/Description	Mat.	Ref.
	Jgo. de juntas para motor		471501-R
0209.AV	Jta. tapa de cilindro Ø 86 ±1.25	MLS	471408-1M
0209.AW	Jta. tapa de cilindro Ø 86 ±1.30	MLS	471408-2M
0209.AX	Jta. tapa de cilindro Ø 86 ±1.35	MLS	471408-3M
0209.AY	Jta. tapa de cilindro Ø 86 ±1.40	MLS	471408-4M
0204.A6	Jgo. tornillos tapa cilindros (HAE14038)		B470800
0249-A6	Junta tapa válvulas	GS 1	471510
0304.34	Junta para cárter	NB 1	470811
0349.V8	Múltiple admisión y escape	AC 1	471415
0313.27	Arandela tapón cárter A 14 x 21 x 1.5 C	CU 1	
1981.43	Arandela pico inyector A 7.5 x 15 x 2 C	CU 4	
	Kit de retenes completo		R471400
0956.48	Jgo. retén válvulas (16)	V 1	R471410V
0127.28	Retén bancada 90 x 110 x 7	V 1	R460211V
0326.22	Retén distribución 42 x 62 x 7	V 1	R460212V
0807.28	Retén árbol de levas 27 x 47 x 7	V 1	R470813V

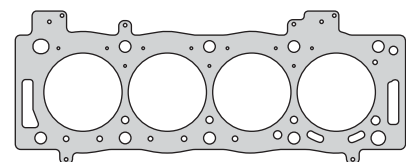

471408

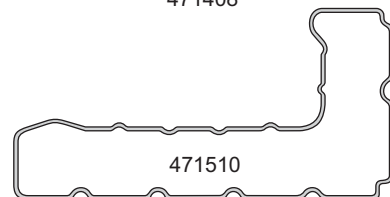

471510

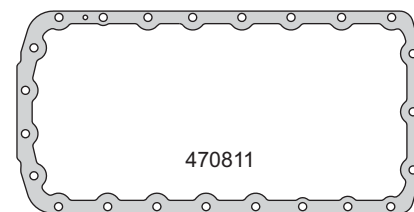

470811



471415



A 14 x 21 x 1.5 C



A 7.5 x 15 x 2 C



R460211V



R460212V



R470813V

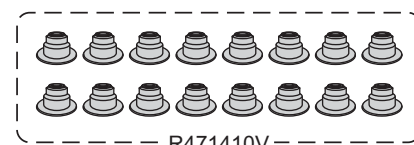

R471410V

PEUGEOT



Motor/Engine	Cm³	HP	Ø
EP3 (8FS/8FP)	1397	95	77
EP3C (8F01)	1397	95	77
EP6 (5FW/5FS)	1598	120	77
EP6C (5F01)	1598	120	77

(DOHC) 16V

Citroën: C3 Picasso - C3 - Berlingo 2009/...
C4 - C4 Coupe - C3 Picasso 2008/...
C4 Picasso 2008/... - DS3 2010/...

Peugeot: 207 - 207 SW - 308 - 308 SW 2007/...
Partner 2008/... - 3008 - 5008 2009/...

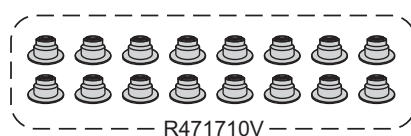
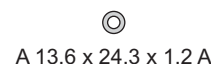
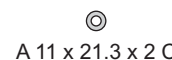
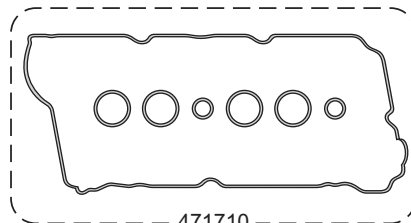
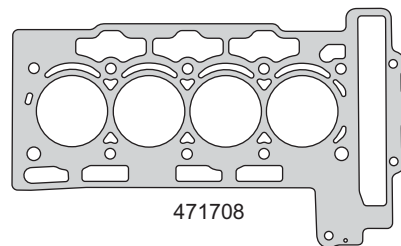

Nº OE	Descripción/Description	Mat.	Ref.
	Jgo. de juntas para motor		● 471700-R MLS
	Junta tapa cilindros Ø 78 ± 0.90	MLS 1	471708
	Sellador líquido - caucho de silicona		TRN0280R
	Conj. junta tapa válvulas (7)	GS 1	471710
	Múltiple admisión	GS 1	471717
	Guarnición goma	GS 1	471727
	Guarnición goma	GS 1	471731
	O´ring G 74 x 3.6	GS 1	
	O´ring G 35 x 2	GS 2	
	Arandela especial A 13.6 x 24.3 x 1.2 A	AC/GS 1	
	Arandela especial A 16 x 21.8 x 2.2 C	CU 1	
	Arandela A 11 x 21.3 x 2 C	CU 1	
	Kit de retenes completo		R471700
	Jgo. retén válvulas (16)	V 1	R471710V
	Retén bancada 85 x 105 x 8	V 1	R560111V
	Retén distribución 61 x 75 x 8	T 1	R471712V

PEUGEOT



Motor/Engine	Cm³	HP	Ø
EP6DT(5FX/5FR)	1598	150/156	77
EP6DT(5FV/5FT)	1598	150/163	77
EP6CDT (5F04)	1598	156	77
EP6DTS (5FY)	1598	156	77

Citroën: C4 - C4 Grand Picasso - C4 Picasso 2008/... - C5 - C5 Tourer 2009/... DS3 2010/...

Peugeot: 207 - 207 CC - 308 - 308 SW 2007/... 3008 2009/... - 508 - 508 SW - 5008 RCZ 2010/...

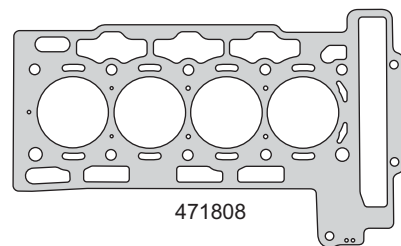

Nº OE	Descripción/Description	Mat.	Ref.
	Jgo. de juntas para motor		● 471800-R MLS
	Junta tapa cilindros Ø 78 \pm 0.90	MLS	1 471808
	Sellador líquido - caucho de silicona		TRN0280R
	Conj. junta tapa válvulas (3)	GS	1 471810
	Múltiple admisión	GS	1 471717
	Guarnición goma	GS	1 471727
	Guarnición goma	GS	1 471731
	O´ring G 74 x 3.6	GS	1
	O´ring G 35 x 2	GS	2
	Arandela especial A 13.6 x 24.3 x 1.2 A	AC/GS	1
	Arandela especial A 16 x 21.8 x 2.2 C	CU	1
	Arandela A 11 x 21.3 x 2 C	CU	1
	Kit de retenes completo		R471700
	Jgo. retén válvulas (16)	V	1 R471710V
	Retén bancada 85 x 105 x 8	V	1 R560111V
	Retén distribución 61 x 75 x 8	T	1 R471712V

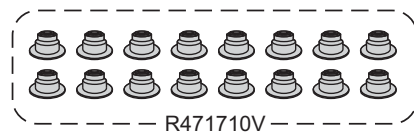
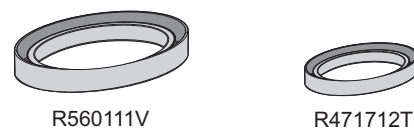
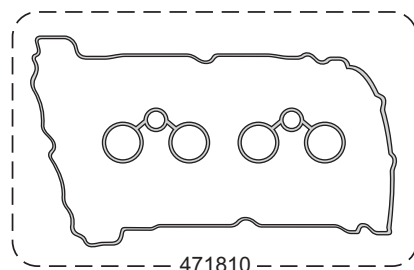

PEUGEOT



Motor/Engine	Cm³	HP	Ø
DW10CTED4 (RH02/RHH) (DOHC) 16V	1997	150/163	85

Citroën: C5 - C5 HDI - C5 Tourer HDI 2009/...
C4 Picasso - C4 Grand Picasso 2010/...

Peugeot: 308 HDI -308 SW HDI / CC HDI 2007/...
407 SW /Coupe HDI - 3008/5008 HDI
Expert Tepee - Expert 3 2009/...



DIESEL

Nº OE	Descripción/Description	Mat.	Ref.
	Jgo. de juntas para motor		471901-R
	Junta tapa cilindros Ø 89 \pm 1.25	MLS	471908-1M
	Junta tapa cilindros Ø 89 \pm 1.30	MLS	471908-2M
	Junta tapa cilindros Ø 89 \pm 1.35	MLS	471908-3M
	Junta tapa cilindros Ø 89 \pm 1.40	MLS	471908-4M
	Jgo. de tornillos para tapa de cilindros		B470800
	Sellador líquido - caucho de silicona		TRN0280R
	Junta tapa válvulas	PLAST 1	471910
	Bomba de agua	NB 1	471914
	Múltiple escape	AC 1	471915
	Múltiple admisión	NB 1	471917
	Salida escape	AC 1	471918
	Junta termostato	GS 1	471919
	Base filtro aceite	GS 1	471927
	Capuchón inyector	AC 4	471930
	Kit de retenes completo		R471900
	Jgo. retén válvulas (16)	P 1	R471910P
	Retén bancada 90 x 110 x 7	P 1	R460211P
	Retén distribución 42 x 62 x 7	P 1	R460212P
	Retén árbol de levas 27 x 47 x 7	P 1	R470813P

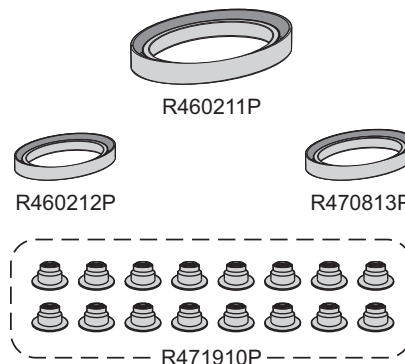
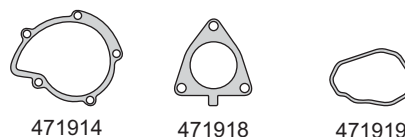
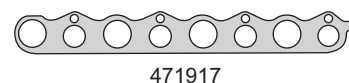
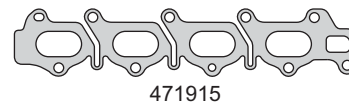
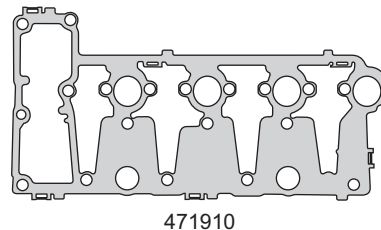
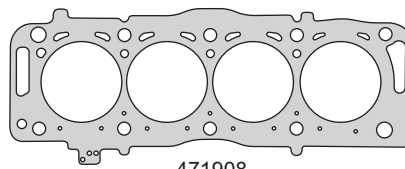

PEUGEOT



Motor/Engine	Cm³	HP	Ø
XD/XDP 4.88	1948	50/59	88

Peugeot: 404 - T4B - T5B - Rastrojero 1972/...

DIESEL



Nº OE	Descripción/Description	Mat.	Ref.
0199541	Jgo. de juntas para motor		500200-R
	Jgo. de juntas superior		500295
0203510	Junta tapa cilindros Ø92 \pm 1.40	NFT 1 1	500205
0203510	Junta tapa cilindros Ø92 \pm 2.40	NFT	500206
0203510	Junta tapa cilindros Ø92 \pm 1.40	NFT	500207
	Junta tapa cilindros Ø98.5 \pm 1.40	NFT	500707
	Junta tapa cilindros Ø92 \pm 1.40	NFT	500907
0203510	Junta tapa cilindros Ø92 \pm 1.70	CNC	500208
	Jgo. tornillos tapa cilindros (HAS17038)		B500200
0249250	Conj. junta tapa de válvulas superior (9)	CG 1 1	500210
0313070	Junta para cárter	CG 1	500211
0321090	Tapa distribución	CB 1	500212
0321100	Placa distribución	CB 1	500213
1206070	Bomba de agua	NB 1 1	500214
0349080	Múltiple de escape	NFT 2 2	500215
	Múltiple de admisión	NB 2 2	500217
1710070	Salida de escape	NFT 1 1	450018
	Salida de escape	NFT 1 1	300918
0321090	Tapa distribución	NB	500225
1104030	Base filtro de aceite	NB 1	500227
0253031	Arandela tapa de válvulas A 8 x 20 x 1.5 F	NB 4 4	500230
7700513014	Arandela tapa válvulas A 7 x 17 x 1.5 F	NB 4 4	550430
0147080	Lateral inspección botadores	CG 2	500231
1925040	Bomba inyectora	CB 1	500233
1179060	Respiradero de cárter	CG 1	500234
0243010	Arandela B16 x 21 x 2.4CN	CN	150035
0127050	Bastón cierre bancada	GS 2	450035
	Central de admisión	NB 1 1	500235
1981.020	Arandela parallamas pico inyector	AC 4 4	560036
	Jgo. múltiple admisión y escape (5)	VS 1	500236
0313070	Junta para cárter	NB	500238
0249050	Tapa de válvulas superior	GS	500239
1981050	Arandela base inyector A 16 x 21 x 2 C	CU 3	500240
	Arandela asiento flauta balancines	GS 1 1	500241
1041100	Base filtro aceite a bomba	NB 1	500242
0236070	Tapa cámara de agua tapa cilindros	NB 2 2	500243
1170031	Varilla nivel aceite	CG 1	500244
0956010	Guía de válvulas G 14 x 7 x 3	GS 8 8	500245
	Regulación bomba inyectora	NB 1	500246
	Arandela cañería gas oil A 12.5 x 15 x 1 C	CU 10	500251
	Arandela conexión pres. Aceite A 8 x 14 x 1 C	CU 6	500252
	Arandela retorno base inyectora A 8 x 12 x 1 C	CU 8	500253
	Arandela tapón des. agua block A 14 x 20 x 1.5 C	CU	500254
0119.010	Soporte motor	CB 1	500255
0313.070	Jgo. empaquetadura bancada (2)	SNA 1	500258
0249.260	Junta para cárter	CGT	500260
0321.100	Junta tapa de válvulas superior	CGT	500261
1925.040	Placa distribución	NH	500262
1041.100	Bomba inyectora	NH	500263
0112.118	Base filtro de aceite bomba	NH	500264
	Jgo. suplemento camisa cilindros (4)	GS 1	500270
	Arandela A16 x 22 x 1C	CU 1	
	Arandela A 14 x 20 x 2 C	CU 4	

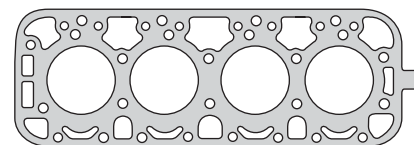

500205

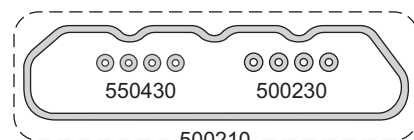

500210

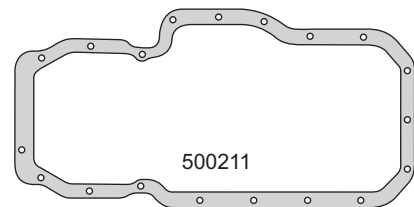

500211



500231

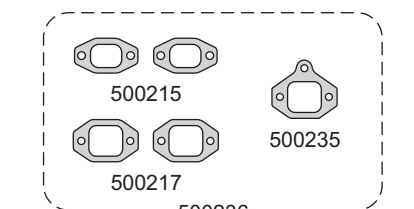

500215

500235

500217

500236

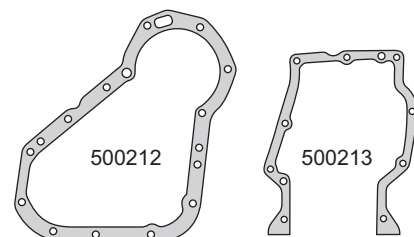

500212

500213

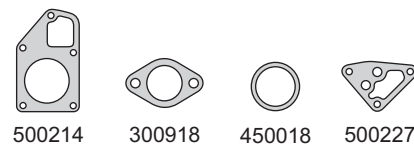

500214

300918

450018

500227



500233

500234

450035

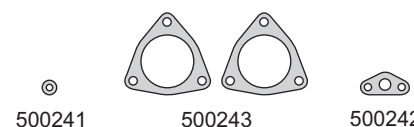

500241

500243

500242

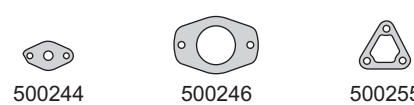

500244

500246

500255



560036



500270

PEUGEOT



Motor/Engine	Cm³	HP	Ø
XDP 6.90	3168	95	90

Peugeot: Pick Up - Camiones Livianos 1976/...

DIESEL



Nº OE	Descripción/Description	Mat.	Ref.
	Jgo. de juntas para motor		500300-R
7932564965	Junta tapa de cilindros Ø 94 \pm 1.40	NFT	500305
7932564965	Junta tapa de cilindros Ø 94 \pm 1.40	NFT	1 500307
	Jgo. de tornillos para tapa de cilindros		B500300
705811400	Conj. junta tapa de válvulas superior (8)	CG	2 500310
7581117000	Junta para cárter	CG	1 500311
7058122700	Tapa distribución	CB	1 500212
7058122000	Contratapa distribución	CB	1 500213
758120300	Bomba de agua	NB	1 500314
7058145700	Jgo. múltiple escape (4)	NFT	1 500215
	Jgo. múltiple admisión (6)	NB	1 500217
	Salida de escape	NFT	1 500318
7932564965	Codo termostato tapa cilindros	NB	1 500319
7932561837	Base filtro de aceite	NB	1 500227
	Arandela tapa de válvulas A 8 x 20 x 1.5 F	NB	6 500230
A-56271500	Lateral botadores	CG	2 500331
7580642000	Bomba inyectora	CB	1 500233
	Respiradero de cárter	CG	1 500234
	Arand. pres. ac./temp./t.cár. B 16 x 22 x 2.4 CN	CN	150035
0127.050	Bastón bancada	GS	2 450035
1981.020	Arandela parallamas inyector	AC	6 560036
	Arandela base inyector A 16 x 21 x 2 C	CU	6 500240
	Arandela conducto flauta balanc. G 16 x 7 x 5	GS	1 500241
	Bomba de aceite a block	NB	1 500242
	Varilla nivel aceite	CG	1 500244
	Retén guía de válvulas G 14 x 7 x 3	GS	12 500245
K-370082	Jgo. empaquetadura bancada (2)	SNA	1 500258
	Jgo. suplemento camisa cilindros (6)	GS	1 500370
	Arandela A 16 x 22 x 1.5 A	AL	3
	Kit de retenes completo		R500300
	Jgo. retén válvulas (12)	P	1 R461510P
0517.001	Retén distribución 42 x 60 x 10	P	1 R450012P

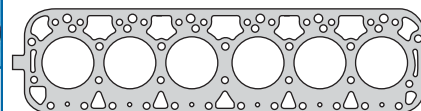

500307

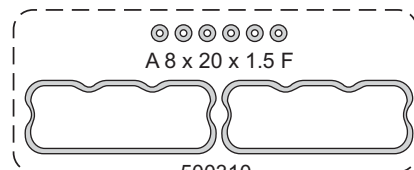

A 8 x 20 x 1.5 F

500310

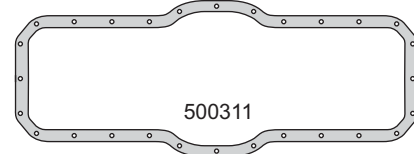

500311



500331

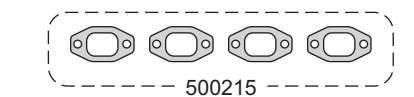

500215

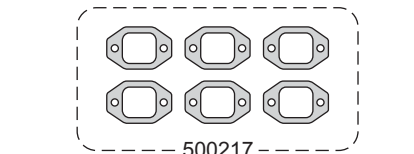

500217

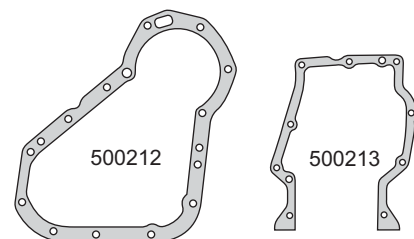

500212

500213

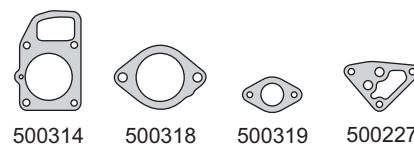

500314

500318

500319

500227

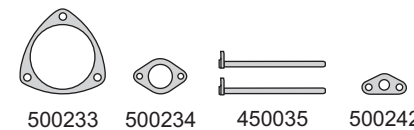

500233

500234

450035

500242



500244

G 16 x 7 x 5

A 16 x 21 x 2 C

G 14 x 7 x 3



560036

A 16 x 22 x 1.5 A



500370



500258

R450012P

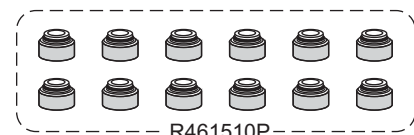

R461510P

PEUGEOT



Motor/Engine	Cm ³	HP	Ø
XD-XDP 4.90	2112	59	90

Peugeot: 504 1980/... - J7/ J9 1980/87
Adaptables Pick Up

DIESEL



Nº OE	Descripción/Description	Mat.	Ref.
	Jgo. de juntas para motor		500600-R
	Junta tapa cilindros Ø 94 ± 1.70	NFT 1	500605
	Jgo. tornillos tapa cilindros (HAS17038)		B500200
0.249.250	Junta tapa de válvulas superior	CG 1	500210
0.313.070	Junta para cárter	CG 1	500211
0.321.090	Tapa distribución	CB 1	500212
0.321.100	Placa distribución	CB 1	500213
1.206.070	Bomba de agua	NB 1	500214
0.349.080	Múltiple escape	NFT 2	500215
	Múltiple admisión	NB 2	500217
	Salida de escape	NFT 1	300918
1.710.070	Salida de escape	NFT 1	450018
0.321.090	Tapa distribución	NB 1	500225
1.104.030	Base filtro de aceite	NB 1	500227
0.253.031	Arandela tapa de válvulas	NB 4	500230
0.147.080	Lateral inspección botadores	CG 2	500231
1.925.040	Bomba inyectora	CB 1	500233
1.179.060	Respiradero de cárter	CG 1	500234
0.243.010	Arandelas tapón cárter B 16 x 22 x 2.4 CN	CN 3	150035
0.127.050	Bastón cierre bancada	GS 2	450035
	Central de admisión	NB 1	500235
	Jgo. admisión y escape (5)	VS 1	500236
0.313.070	Junta para cárter	NB	500238
0.249.050	Junta tapa de válvulas superior	GS	500239
1.981.050	Arandela base inyector A 16 x 21 x 2 C	CU 4	500240
	Arandela asiento flauta balancines	GS 1	500241
1.041.100	Base filtro aceite a bomba	NB 1	500242
0.236.070	Tapa cámara de agua tapa cilindros	NB 2	500243
1.170.031	Varilla nivel aceite	CG 1	500244
0.956.010	Guía de válvulas	GS 8	500245
	Regulación bomba inyectora	NH 1	500246
	Jgo. empaquetadura cigüeñal (2)	SNA 1	500258
0517.001	Retén distribución 42 x 60 x 10	P 1	R450012P

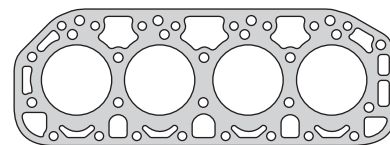

500605

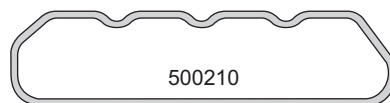

500210

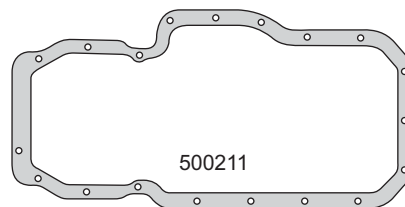

500211



500231

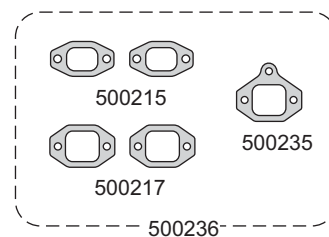

500215

500235

500217

500236

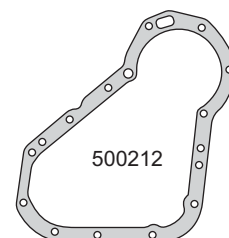

500212

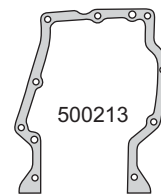

500213



500214



300918



450018



500227

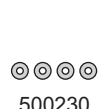

500230

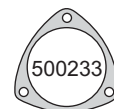

500233



500234



450035



500241



500242



500244



500243



500245



500246

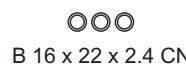

B 16 x 22 x 2.4 CN



A 16 x 21 x 2 C

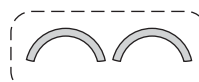

500258



R450012P

RASTROJERO



Motor/Engine	Cm³	HP	Ø
Borgward D4M	1758	42	78

Rastrojero: Pick Up - NP6 1955/66

DIESEL



Nº OE	Descripción/Description	Mat.	Ref.
	Jgo. de juntas para motor		● 500000-R
C-46-12-1	Junta tapa cilindros Ø 78 \pm 1.40	NFT	1 500005
C-46-12-1	Junta tapa válvulas superior	CG	1 500010
E-41-12-24	Junta para cárter	CG	1 500011
0713015600	Tapa distribución	CB	1 500012
B-41-11-4	Placa distribución	CB	1 500013
B-41-11-5	Bomba de agua	NB	1 500014
E-15-16-5	Jgo. múltiple escape (4)	NFT	1 500015
36 DIN 71511	Tubo admisión	GS	2 500017
E-41-12-35	Salida de escape	NFT	1 500018
1401123	Bomba agua a block	NB	1 500019
E-15-16-7	Termostato	CB	1 500030
E-12-12-36	Base carcasa termostato	CB	1 500031
E-12-12-24	Tapa filtro aceite	NB	1 500032
E-41-11-11	Filtro aceite a block	NB	1 500033
E-41-11-12	Base bomba aceite	NB	1 500034
E-12-15-19	Válvula reguladora	NB	2 500035
E-41-17-7	Junta tapa válvulas inferior	CG	1 500036
0463023400	Buje porta engranaje bomba aceite	CG	1 500037
E-46-15-3	Tapa bomba agua	NB	1 500038
	Tubo descarga gases cárter	NB	1 500039
E-12-11-57	Bomba inyectora distribución	NB	1 500040
E-41-17-3	Base bomba combustible	NB	1 500041
0713064700	Acople bomba agua	NB	1 500042
E-11-16-21	Ajuste bomba inyectora	NB	1 500043
036067000	Arandela porta tobera A 23 x 28 x 2	NH	4 500044
E-41-12-7	Bomba alimentación bomba inyectora	NB	1 500045
	Junta retén distribución	FIE	1 500046
	Arandela porta inyector A 32 x 36 x 0.5 C	CU	4 500047
E-41-12-6	Arandela asiento inyector A 32 x 36 x 1 C	CU	4 500048
	Caja dirección	CB	500049
	Jgo. juntas caja velocidades	VS	500050
	Diferencial	CB	500055
P-6332003	Palier	CB	500056
E-28-24-43	Jgo. empaquetadura cigüeñal (2)	SNA	1 500258
	Jgo. juntas para cárter	CGT	500060
	Kit de arandelas (12)	VS	1 500075
	Kit de retenes completo		R500100
	Jgo. retén válvulas (8)	P	1 R500010P
	Retén distribución 42 x 68 x 10/16	N	1 R500012N

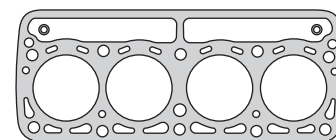

500005

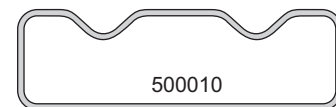

500010

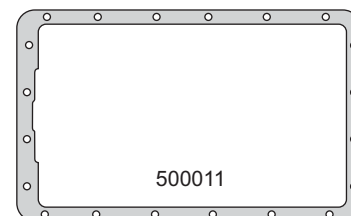

500011

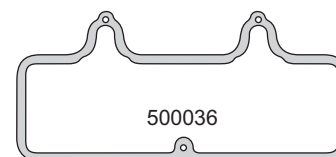

500014

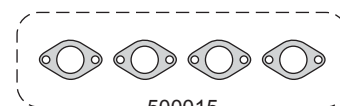

500012

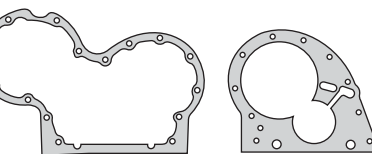

500013

500013

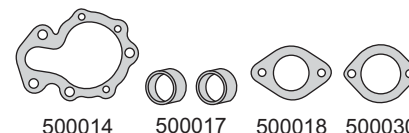

500014

500017

500018

500030



500019

500031

500033

500032

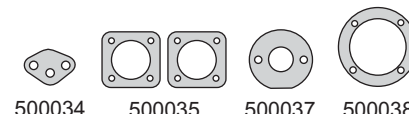

500034

500035

500037

500038

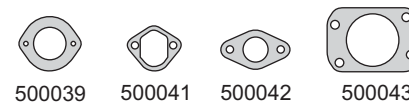

500039

500041

500042

500043

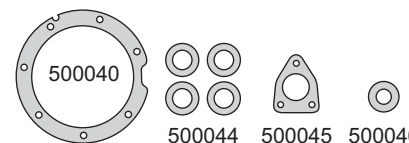

500040

500044

500045

500046



500047

500048



500258

R500012N



R500010P

RASTROJERO



Motor/Engine	Cm³	HP	Ø
Borgward D301 - E1D	1797	52	78

Rastrojero: Pick Up - Kombi - Frontal
NC62/NP66 - P63/P64
C66/P67 1964/71



DIESEL

Nº OE	Descripción/Description	Mat.	Ref.
	Jgo. de juntas para motor		500100-R
130906146	Junta tapa cilindros Ø 80 ± 1.40	NFT	1 500105
130906146	Junta tapa válvulas	CG	1 500110
130907111	Junta para cárter	CG	1 500011
0713015600	Tapa distribución	CB	1 500112
130903110	Placa distribución	CB	1 500113
130903104	Cuerpo bomba de agua	NB	1 500114
130920108	Jgo. múltiple escape (4)	NFT	1 500015
	Múltiple admisión	GS	2 500017
36 DIN 71511	Múltiple admisión	NH	500117
130946105	Salida de escape	NFT	1 500118
P6337001	Placa bomba de agua	NB	1 500119
130920109	Termostato	CB	1 500030
E-12-12-36	Base carcasa termostato	CB	1 500031
E-12-12-24	Bomba inyectora distribución	NB	1 500131
130903111	Tapa filtro aceite	NB	1 500032
E-41-11-11	Tubo descarga gases cárter	NH	1 500132
130901122	Filtro aceite a block	NB	1 500033
E-41-11-12	Separador filtro aceite a block	NB	1 500133
130932105	Base bomba aceite	NB	1 500034
E-12-15-18	Soporte bomba inyectora	NB	1 500134
130942101	Válvula reguladora	NB	2 500035
E-41-17-7	Separador filtro aceite a carcasa	NB	1 500135
130924104	Buje porta engranaje bomba aceite	CG	1 500037
E-46-15-3	Arandela porta tobera A 28 x 36 x 0.5 A	AL	4 500137
130906143	Anillo o'ring admisión G 42 x 3.5	GS	1 500138
	Base bomba combustible	NB	1 500041
0713064700	Bomba alimentación bomba inyectora	NB	1 500045
	Palier diferencial TRANSAX	CB	500156
	Jgo. caja velocidades	CB	500050
	Palier TRANSAX	CB	500156
	Jgo. empaquetadura cigüeñal (2)	SNA	1 500258
	Kit de retenes completo		R500100
	Jgo. retén válvulas (8)	P	1 R500010P
	Retén distribución 45 x 68 x 10/16	N	1 R500012N

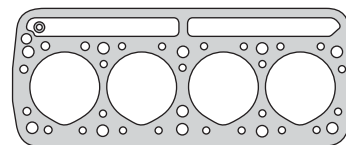

500105

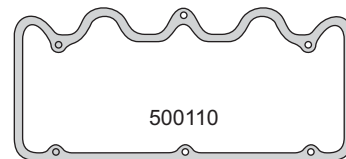

500110

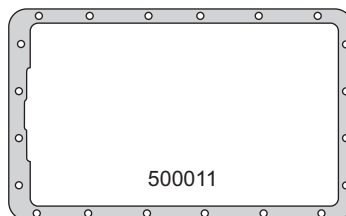

500011

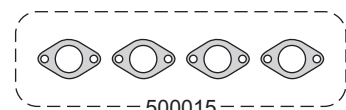

500015

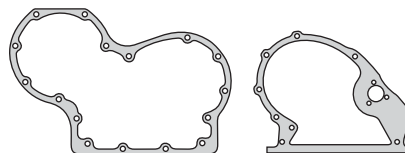

500112

500113

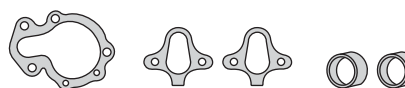

500114

500117

500017



500118

500119

500030

500031

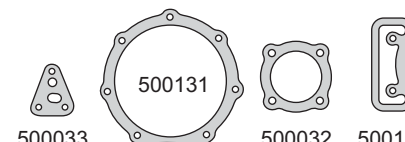

500033

500131

500032

500132

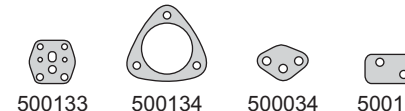

500133

500134

500034

500135



500035

500137

500138



500037

500041

500045

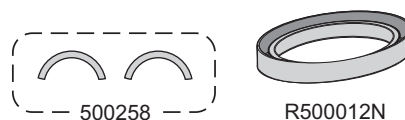

500258



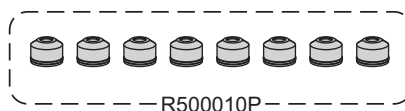







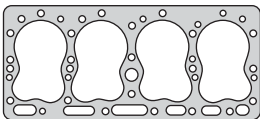

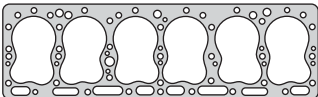

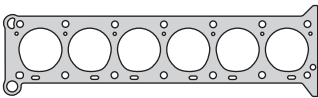



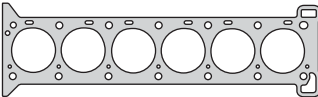

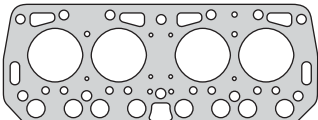

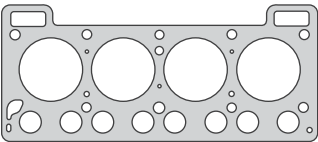

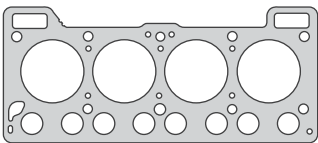

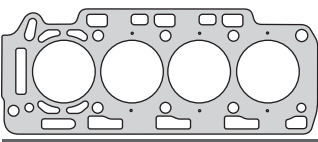

R500012N

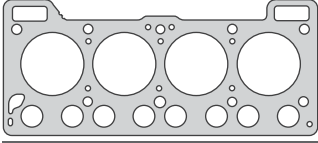

R500010P

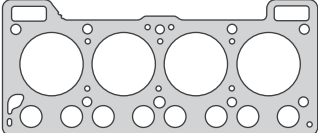









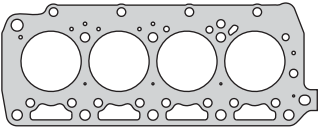

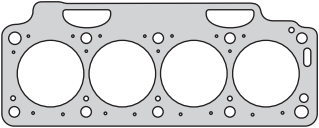

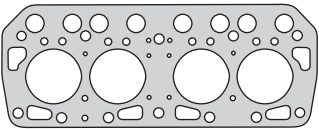

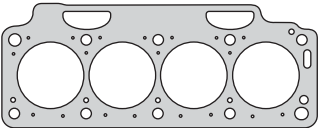



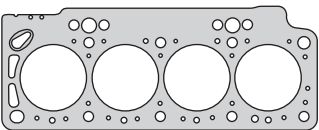



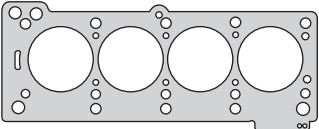

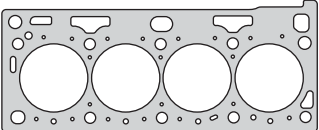

MOTORES NAFTA - DIESEL

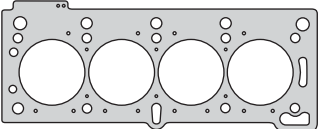
	540005	Código	Ø	⊗	Kit Bulón	Modelo	Jeep Continental - Bergantin 1954/74
		540005	86.5	1.70		Motor	2470cc. 4L - 151 80HP Ø84.14 (540000-R)  pág. 401
	540105	Código	Ø	⊗	Kit Bulón	Modelo	Estanciera - Baqueano - Gladiator - Continental - Kaiser Carabela Manhattan 1955/... - Bergantin Super 1954/67
		540105	87.0	1.70		Motor	3705cc. L226 110HP Ø84.14 (540100-R)  pág. 402
	540205	Código	Ø	⊗	Kit Bulón	Modelo	Torino - Rambler - Utilitario - Gladiator - Jeep T80 1966/73 Torino Tornado 300SL 1966/73 Torino Tornado Reforma 1972/74
		540205	87.5	1.40		Motor	2966cc. OHC 181 4B - 300/300S/380 Ø84.94 (540200-R)  pág. 403 2966cc. OHC 181/230/300 140/160HP Ø84.94 (540400-R)  pág. 405 3770cc. OHC 4B 180HP Ø84.94 (540500-R)  pág. 406
	540305	Código	Ø	⊗	Kit Bulón	Modelo	Torino 1973/...
		540305	87.5	1.40		Motor	3770cc. OHC 181/230/300/380 7B Ø84.94 (540300-R)  pág. 404
	550005 - 550006	Código	Ø	⊗	Kit Bulón	Modelo	Gordini - Floride - Dauphine 4L - 4F 1960/64
		550005 550006	59.0 59.0	1.40 2.40		Motor	845cc. 670-04/05 Ø58 (550000-R)  pág. 407
	550405 - 550406 - 550407	Código	Ø	⊗	Kit Bulón	Modelo	R12 - R4L - 4S - R6 - R4 1970/... - R12TS - R15 1972/75
		550405 550406 550407	74.0 74.0 74.0	1.40 2.40 1.40	B550400  (HAS17038)	Motor	1289cc. 688.01/10-810.88 54HP Ø73 (550400-R)  pág. 408
	550505 - 550506 - 550507	Código	Ø	⊗	Kit Bulón	Modelo	R12TS - R5TX 1976/80 - TXL 1310/1410
		550505 550506 550507	77.0 77.0 77.0	1.40 2.40 1.40	B550400  (HAS17038)	Motor	1397cc. 847 63/68HP Ø76 (550500-R)  pág. 409 1397cc. TXL 60HP Ø76 (560200-R)  pág. 416
	550605 - 550606 - 550607	Código	Ø	⊗	Kit Bulón	Modelo	Master 1981/93 - R18 - Fuego 1981/86 - R21 - R25 - Espace 1984/97 R20 1977/84 - R18 1985/... - Trafic - Master 1989/...
		550605 550606 550607	89.0 89.0 89.0	1.40 2.40 1.20	B550600 B550600-1  (HAS19038)	Motor	1995cc. 829/J5R 80HP - J6R/J7R 102/105/110/116/120HP Ø88 2165cc. 851 - J7T 95/107/115/120HP Ø88 (550600-R)  pág. 410
	550705 - 550707	Código	Ø	⊗	Kit Bulón	Modelo	R9 1981/89 - R11 1983/89 - R19 - R21 1988/93 - Super Cinco 1985/93 Twingo - Clio - Express 1992/... R12 - R18 - Junior - Trafic 1982/...
		550705 550707	77.0 77.0	1.40 1.20	B550400  (HAS17038)	Motor	1239cc. C3G 55HP Ø74 (570000-R)  pág. 423 1397cc. C1J - C2J 60/67HP Turbo 104/110HP Ø76 (550700-R)  pág. 411 1397cc. 847 48HP Ø76 (550800-R)  pág. 412
	550905 - 550906 - 550907	Código	Ø	⊗	Kit Bulón	Modelo	R9 - R11 - R12 - R18 - R19 1988/... R19 - Clio - Express 1996/98
		550905 550906 550907	78.0 78.0 78.0	1.40 2.40 1.20	B550400  (HAS17038)	Motor	1565cc. C1L - C2L Carburador Ø77 (550900-R)  pág. 413 1597cc. C3L Inyección 74HP Ø76 (560500-R)  pág. 419

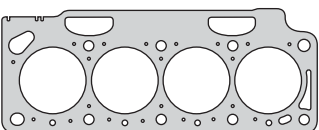

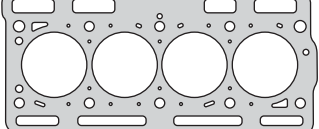
MOTORES NAFTA - DIESEL

	560007	Código	Ø	≠	Kit Bulón	Modelo	R18 1981/86 - R21 1984/97 - Trafic - Master 1981/97
	560007-2M	87.0	1.60	 B560000 (HAS19038) (HAE18038) (HAH10055)	Motor	2068cc. 852/J8S 65/86HP Ø86 - DIESEL (560001-R)  pág. 414	
	560007-1M	87.0	1.70				
560007-3M	87.0	1.80					
	560107	Código	Ø	≠	Kit Bulón	Modelo	R19 1989/95 - R11 1986/89 - Clio 1990/93 - R21 Trafic - Super Cinco 1986/94
	560107	81.7	1.20	 B560600 B560600-1 (HAE14038)	Motor	1721cc. F2N - F3N 75/92HP Ø81 (560100-R)  pág. 415	
	560305 - 560307	Código	Ø	≠	Kit Bulón	Modelo	R5 1973/84
	560305	59.0	1.40		Motor	845cc. 839.01 - 800.10 39HP Ø58 (560300-R)  pág. 417	
	560307	59.0	1.40				
	560407	Código	Ø	≠	Kit Bulón	Modelo	R19 - Clio - Laguna 1991/98 Megane RT - Scenic - Laguna RT - RXE
	560407	83.5	1.40	 B560600 B560600-1 (HAE14038)	Motor	1794cc. F3P Inyección 90/96HP Ø82.7 (560400-R)  pág. 418 1998cc. F3R 722/796/729 115HP Ø82.7 (570400-R)  pág. 427	
	560607	Código	Ø	≠	Kit Bulón	Modelo	R9 - R19 - Express - Clio - Kangoo - Trafic - Scenic - Megane
	560607-2M	81.0	1.60	 B560600 B560600-1 (HAE14038)	Motor	1870cc. F8Q 65HP Ø80 - DIESEL (560601-R)  pág. 420 1870cc. F8Q (con cárter aluminio) 65HP Ø80 - DIESEL (560701-R)  pág. 421	
	560607-1M	81.0	1.70				
560607-3M	81.0	1.80					
	560807	Código	Ø	≠	Kit Bulón	Modelo	E5F/E7F/E6J/E7J Clio - R19 1990/98 - Express 1990/95 Kangoo 2001/... - Megane 1995/97
	560807	77.0	1.40	 B560800 (HAE12038)	Motor	1171cc. E5F/E7F 55/60HP Ø75.8 1390cc. E6J/E7J Energy 77/80HP Ø75.8 (560800-R)  pág. 422	
	570107	Código	Ø	≠	Kit Bulón	Modelo	Clio 1991/99 - R19 1989/96 - Clio Williams 1993/... Megane Coupe 1995/99 - Spider Sport 1993/...
	570107	84.0	1.30	 B570100 (HAT55055) (HAT55100)	Motor	1764cc. F7P 700/704/720/722 135/140HP Ø82 (580495-R)  pág. 435 1764cc. F7P 700/704/720/722 16V 133/140HP Ø82 (570100-R)  pág. 424 1998cc. F7R 700/710/714 150HP Ø82.7 (570100-R)  pág. 424	
	570207	Código	Ø	≠	Kit Bulón	Modelo	Megane Scenic RN - Clio 1998/... Clio II 1998/05 - Sandero 2007/... - Symbol
	570207	80.0	1.30	 B570200 (HAE12038)	Motor	1598cc. K7M - 744/745 75/90HP Ø79.5 (570200-R)  pág. 425	
	570307	Código	Ø	≠	Kit Bulón	Modelo	Megane Coupe DTI 731 2000/... - RN - RT - Laguna 716/730/734/750 Scenic 736 - Espace 722 1999/... - Kangoo 2000/...
	570307-2M	81.0	1.40	 B570300 (HAE14038)	Motor	1870cc. F9Q Turbo (SOHC) 8V 80/100HP Ø80 (570301-R)  pág. 426 Inyección Directa - DIESEL	
	570307-1M	81.0	1.50				
570307-3M	81.0	1.60					
	570507	Código	Ø	≠	Kit Bulón	Modelo	Twingo 1996/... - Clio 1995/... - Kangoo 1997/... - D7D Twingo 2001/...
	570507	70.0	1.40	 B570500 (HAE12038)	Motor	1149cc. D7F/D7D 734/730/700/701/710 55/60HP Ø69 (570500-R)  pág. 428	





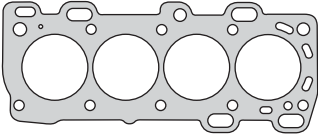
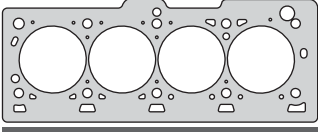
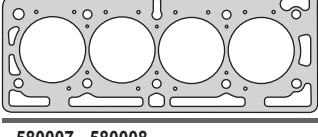
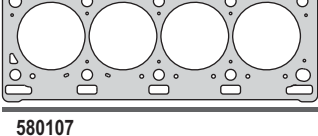
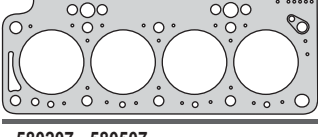
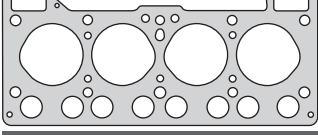
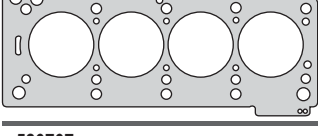
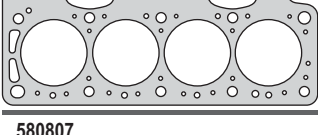
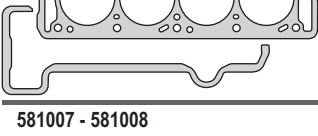
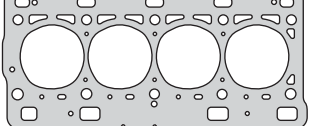





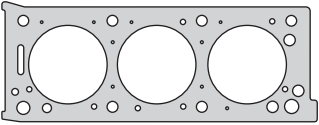
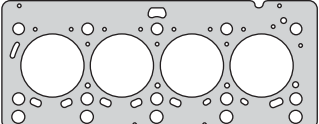

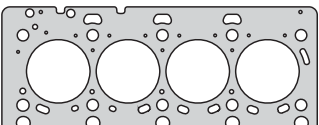

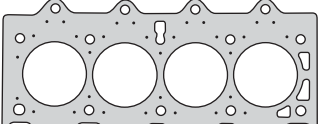

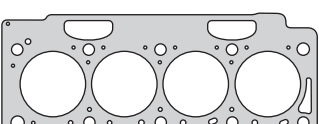
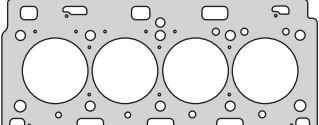
MOTORES NAFTA - DIESEL

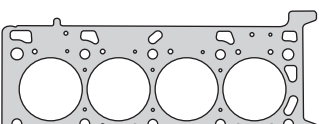
	570607	Código	Ø	Δ	Kit Bulón	Modelo
	570607	85.0	1.70	B570600 (HAS14038)	Laguna N7Q/700/704 1994/99 - Space N7Q 1996/... Safrane N7Q/710/711 1996/99	
	570907 - 570908	Código	Ø	Δ	Kit Bulón	Modelo
	570907 570908	80.5 80.5	1.40 1.10	B570900 (HAE12038)	K4J - Clio II 2001/... - Scenic 1999/... - Megane II 2003/... K4M - Clio - Scenic - Megane - Laguna 1998/00 - Logan 2007/... Fluence - Duster Serie 838 - Symbol	
	571008	Código	Ø	Δ	Kit Bulón	Modelo
	571008	80.5	0.42	B570200 (HAE12038)	Sandero 2008/... - Logan 2004/...	
	580007 - 580008	Código	Ø	Δ	Kit Bulón	Modelo
	580007 580008	84.0 84.0	1.20 0.60	B580000 (HAE14038)	Laguna 1998/... - Laguna - Scenic - Megane - Kangoo 2001/... Megane - Scenic - Grand Espace - Laguna - Master - Trafic 1999/... Clio II Sport 2001/... - Duster 2011/...	
	580107	Código	Ø	Δ	Kit Bulón	Modelo
	580107-2M 580107-1M 580107-3M	80.7 80.7 80.7	1.45 1.50 1.60	B570300 (HAE14038)	Clio II 630/632/662 - Kangoo 630/632/662 1998/... - Scenic 1999/... Rodeo Trafic 600/606 1998/... - Express 644/648 1997/... - Megane 1997/... R19 DT 1991/96 - Megane DT 1996/97 - Scenic DT 19986/...	
	580207 - 580507	Código	Ø	Δ	Kit Bulón	Modelo
	580207 580507	72.0 74.0	1.30 1.30	B550400 (HAS17038)	Super Cinco 1985/93 - R9 - R11 1981/89 - Clio - Express 1990/93 R12 1969/75 - R12TS 1973/75 - R15 1976/80 - R5 1974/84 Rodeo 1980/81 - Estafette 1974/81	
	580607	Código	Ø	Δ	Kit Bulón	Modelo
	580607	77.0	1.95	B550400 (HAS17038)	Super Cinco - R11 - R9 Turbo 1984/93	
	580707	Código	Ø	Δ	Kit Bulón	Modelo
	580707-2M 580707-1M 580707-3M	79.0 79.0 79.0	1.65 1.75 1.85	B560600 B560600-1 (HAE14038)	Express 1987/96 - Super Cinco 1988/96 - R9 - R11 1988/89	
	580807	Código	Ø	Δ	Kit Bulón	Modelo
	580807	80.5	1.25	B550400 (HAS17038)	Trafic - Fuego - R18 1978/... - Fuego 1980/95 - R12/R15/R16/R18 R20/R17 1972/...	
	581007 - 581008	Código	Ø	Δ	Kit Bulón	Modelo
	581007 581008	70.0 70.0	1.20 0.35	B581000 (HAE12038)	Clio II - Kangoo .../00 - Twingo - Clio II - Kangoo 2001/... Clio 2000/... - Kangoo 2003/... - Clio II 2005/... - Twingo 2004/...	

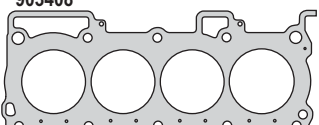

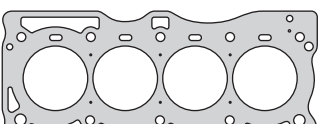
MOTORES NAFTA - DIESEL

	581107 Código	Ø 95.0	∇ 1.60	Kit Bulón B452500	Modelo Laguna - Safrane - Espace 1992/98
	581107	95.0	1.60	B452500	Motor 2963cc. Z7X 167/170HP V6 Ø93
	581207 - 581208 Código	Ø 78.0	∇ 1.00	Kit Bulón B581200	Modelo Clio II DCI 2001/... - Series 700/702/704/710/722/728/729 Kangoo DCI 2001/... - Megane DCI 2002/... - Logan 2007/... - Symbol
	581207-2M	78.0	1.00	B581200	Motor 1461cc. K9K (SOHC) 65/80/82HP Ø76 - DIESEL (581201-R)  pág. 441
	581207-1M	78.0	1.20	(HAE18038)	
	581207-3M	78.0	1.40	(HAE18038)	
581208	78.0	0.65	(HAE18038)		
	581307 - 581308 Código	Ø 78.0	∇ 1.00	Kit Bulón B581200	Modelo Megane II - Sandero DCI Serie 794, Sandero Stepway DCI, Symbol DCI Logan 2006/...
	581307-2M	78.0	1.00	B581200	Motor 1461cc. K9K DCI (SOHC) 8V 65/100HP Ø76 - DIESEL (581301-R)  pág. 442
	581307-1M	78.0	1.20	(HAE18038)	
	581307-3M	78.0	1.40	(HAE18038)	
581308	78.0	0.65	(HAE18038)		
	581407 Código	Ø 88.0	∇ 1.80	Kit Bulón B581400	Modelo Laguna D 706/790 1996/... - Laguna TD 740/752/760/792/794 1996/...
	581407	88.0	1.80	B581400	Motor 2188cc. G8T D/TD 12V 85/115HP Ø87 - DIESEL (581400-R)  pág. 443
	581507 Código	Ø 88.0	∇ 1.80	Kit Bulón	Modelo Laguna 1996/98
	581507	88.0	1.80	(HAE18038)	Motor 2188cc. GT8 752/792 12V 85HP Ø87 - DIESEL
	581608 Código	Ø 81.0	∇ 1.35	Kit Bulón B570300	Modelo Laguna DCI - Trafic DTI - Kangoo - Master II DTI - Megane Cabriolet DTI Mitsubishi Carisma 1999/... - Space Star TD - Volvo S40, V40 TD 2001/...
	581608	81.0	1.35	(HAE14038)	Motor 1870cc. F9Q-722/731/732/733/736/760/762/782/790/820 80/110HP Ø80 - DIESEL
	581808 Código	Ø 90.0	∇ 0.95	Kit Bulón B581800	Modelo Master 2001/... - Trafic 2003/...
	581808	90.0	0.95	(HAE18038)	Motor 2463cc. G9U-720/724/730/750/754 115HP Ø87 (581800-R MLS)  pág. 445 DIESEL
	582308 Código	Ø 85.0	∇ 0.80	Kit Bulón B581800	Modelo Espace IV 2006/... - Laguna II .../2005 - Megane II 2006/10 - Koleos
	582308	85.0	0.80	(HAE18038)	Motor 1995cc. M9R 700/740 (DOHC) 16V 150HP Ø84 (582300-R MLS)  pág. 448 DIESEL
	903408 Código	Ø 84.5	∇ 0.48	Kit Bulón B903400	Modelo Fluence - Megan III 2001/...
	903408	84.5	0.48	(HAE18038)	Motor 1998cc. M4R 714 (DOHC) 16V Ø84 (582200-R MLS)  pág. 447
	903508 Código	Ø 89.5	∇ 0.65	Kit Bulón B903500	Modelo Koleos 4x2/4x4
	903508	89.5	0.65	(HAE18038)	Motor 2488cc. 2TR (DOHC) 16V 170HP Ø89 - DIESEL (582100-R MLS)  pág. 446

JEEP IKA**taranto**

Motor/Engine	Cm³	HP	Ø
4L - 151	2470	80	84.14

Jeep Ika: Jeep Continental - Bergantin 1954/74



Nº OE	Descripción/Description	Mat.	Ref.
2090523	Jgo. de juntas para motor		540000-R
2009064	Junta tapa cilindros Ø 86.5 ± 1.70	NFT	1 540005
2000343	Junta tapa válvulas	CG	1 540010
2016713	Jgo. junta para cárter (4)	CG	1 540011
701290	Tapa distribución	CG	1 540012
711930	Placa distribución	CB	1 540013
733809	Tapa bomba de agua	NB	1 540014
2009065	Múltiple admisión y escape	NFT	1 540016
2000129	Entre múltiples	NFT	1 540017
2009067	Salida de escape	FCH	1 540018
733612	Bomba de agua a block	NB	1 540019
2091527	Jgo. juntas carburador cárter	VS	540020
2000437	Base carburador	NB	1 540025
701392	Tapa bomba aceite	CU	1 540027
2016726	Base bomba nafta	NB	1 540028
	Entre múltiple	NFT	1 540029
731377	Salida agua a termostato	CB	1 540032
2017354	Tapa diferencial - Dana 44	CG	540034
733612	Bomba de agua a block	NB	540039
	Tacitas block	GS	540040
	Vaso bomba nafta	CG	1 540041
2092024	Jgo. juntas caja velocidades simple	VS	540050
	Jgo. juntas caja velocidades doble tracción	VS	540051
2005932	Palier	CB	540056
731046	Jgo. juntas empaquetadura bancada (2)	SNA	1 540058
	Palier	CB	540062
2017354	Tapa diferencial - Dana 44	CGT	540068
2017354	Tapa diferencial - Dana 44	NB	300086
	Retén distribución 52.38 x 81.02 x 11	P	1 R540012P

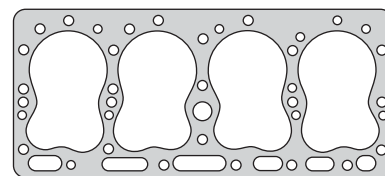

540005

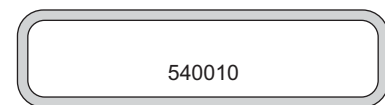

540010

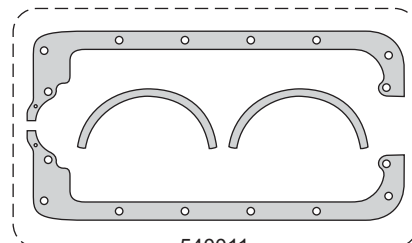

540011

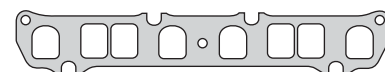

540012

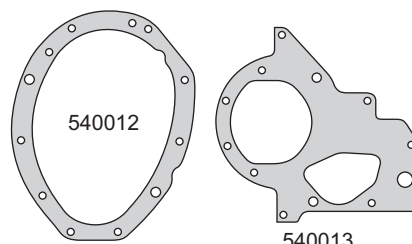

540012

540013

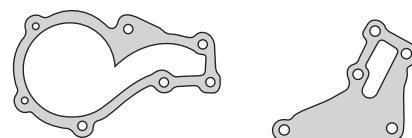

540014

540019

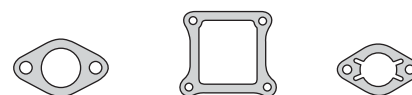

540018

540017

540025



540027

540028

540029

540041

540032

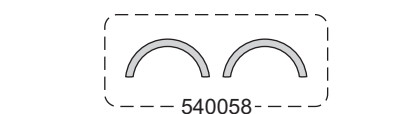

540058



R540012P

IKA



Motor/Engine	Cm³	HP	Ø
L226	3705	110	84.14

Ika: Estanciera - Baqueano - Gladiator
Continental - Kaiser Carabela
Manhattan 1955/...
Bergantin Super 1954/67



RENAULT / IKA

Nº OE	Descripción/Description	Mat.	Ref.
2090610	Jgo. de juntas para motor		540100-R
733567	Junta tapa cilindros Ø 87 ± 1.70	NFT 1	540105
706158	Junta tapa válvulas	CG 1	540110
2016712	Jgo. junta para cárter (4)	CG 1	540111
701290	Tapa distribución	CG 1	540012
711930	Placa distribución	CB 1	540013
733809	Tapa bomba de agua	NB 1	540014
2009066	Múltiple admisión y escape	NFT 1	540116
735493	Entre múltiples	NFT 1	540117
745608	Salida de escape	FCH 1	540118
733612	Bomba de agua a block	NB 1	540019
2090684	Jgo. juntas carburador CARTER WCD	VS	540120
2093836	Jgo. juntas carburador CARTER RBS	VS	540121
746043	Base carburador	NB 1	540125
701392	Tapa bomba aceite	CU 1	540027
2016726	Base bomba nafta	NB 1	540028
731377	Salida agua a termostato	CB 1	540032
2017354	Tapa diferencial - Dana 44	CG	540034
733612	Bomba de agua a block	NB	540039
	Tacitas block	GS	540040
	Vaso bomba nafta	CG 1	540041
2092024	Jgo. juntas caja velocidades simple	VS	540050
	Jgo. juntas caja velocidades doble tracción	VS	540051
2005932	Palier	CB	540056
731046	Jgo. juntas empaquetadura bancada (2)	SNA 1	540058
	Palier	CB	540062
2017354	Tapa diferencial - Dana 44	CGT	540068
2017354	Tapa diferencial - Dana 44	NB	300086
	Retén distribución 52.38 x 81.02 x 11	P 1	R540012P

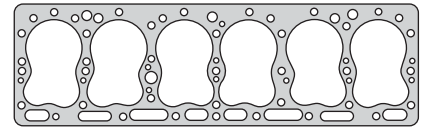

540105

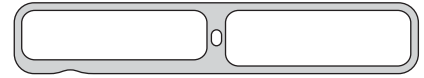

540110

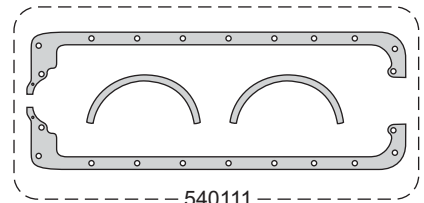

540111



540116

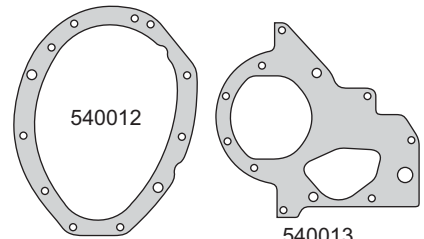

540012

540013

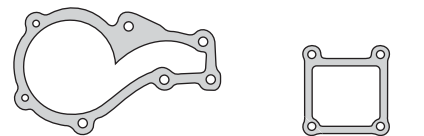

540014

540017

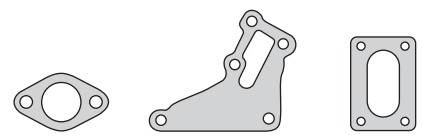

540018

540019

540125



540027

540028

540032

540041



540058



R540012P

IKA



Motor/Engine	Cm³	HP	Ø
OHC 181 4B 300/300S/380	2966		84.94

Ika: Torino - Rambler - Utilitario
Gladiator - Jeep T80 1966/73



Nº OE	Descripción/Description	Mat.	Ref.
2096686	Jgo. de juntas para motor		540200-R
2069497	Junta tapa cilindros Ø 87.5 ± 1.40	NFT	1 540205
2019161	Conj. junta tapa válvulas (5)	GS	1 540210
2093746	Jgo. junta para cárter (4)	CG	1 540211
2069554	Tapa distribución	NB	1 540212
2017031	Tapa inspección distribución	NB	1 540213
2017008	Tapa bomba de agua	NB	1 540214
2069066	Múltiple escape	NFT	1 540216
2068824	Múltiple admisión	NFT	1 540217
2058422	Salida de escape	FCH	1 540218
2068331	Termostato	CB	1 220119
2096476	Jgo. juntas carburador Holley 2B	VS	540220
	Jgo. juntas carburador Holley importado	VS	540221
2096382	Jgo. juntas carburador Weber 45DCDE	VS	540222
2069022	Base carburador	NB	1 540225
2018961	Tapa bomba aceite	CU	1 540227
2016726	Base bomba nafta	NB	1 540028
	Media distribución	NB	540230
	Junta salida termostato	CB	540231
2018235	Base bomba aceite	NB	1 540232
	Base bomba aceite	NB	1 540332
2068764	Arandelas tapa válvulas	GS	4 540233
2017354	Tapa diferencial Dana 44	CG	540034
2017008	Bomba agua	CB	540234
	Base caballete levas	NFT	540236
	Junta vaso bomba nafta	CG	1 540041
2019532	Jgo. juntas empaquetadura bancada (2)	SNA	1 540258
2017354	Tapa diferencial - Dana 44	CGT	540068
2086863	O´ring conducto aceite a distrib. G 12.29 x 3.53	GS	4 540269
2017354	Tapa diferencial - Dana 44	NB	300086
	Kit de retenes completo		R540200
	Jgo. retén válvulas (12)	P	1 R540210P
	Retén distribución 52.38 x 81.02 x 11	P	1 R540012P

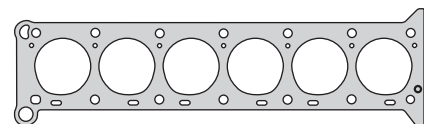

540205

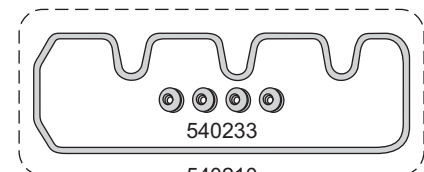

540233

540210

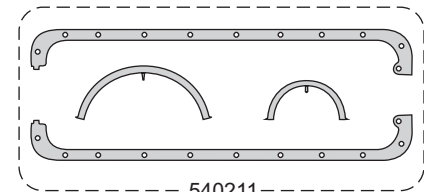

540211



540216



540217

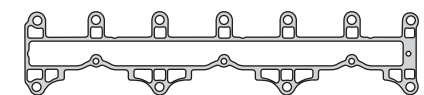

540236

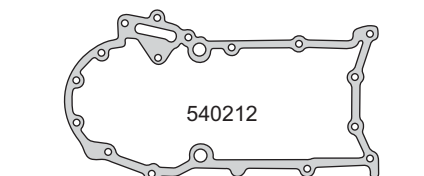

540212



540213 540214 540218

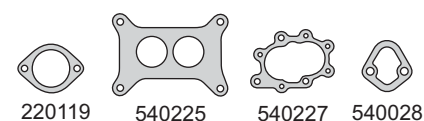

220119 540225 540227 540028

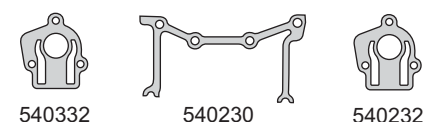

540332 540230 540232



540041 540258 540269



R540012P

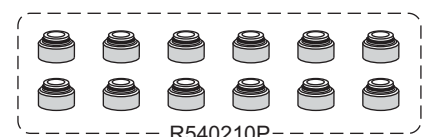

R540210P

RENAULT / IKA

TORINO



Motor/Engine	Cm³	HP	Ø
OHC 181 - 230 300 - 380 7B	3770		84.94

Ika: Torino 1973/...



RENAULT / IKA

Nº OE	Descripción/Description	Mat.	Ref.
	Jgo. de juntas para motor		540300-R
2077745	Junta tapa cilindros Ø 87.5 ± 1.40	NFT 1	540305
2214786	Conj. junta tapa válvulas superior (5)	GS 1	540310
2098986	Jgo. junta para cárter (4)	CG 1	540311
2077747	Tapa distribución	NB 1	540312
2017031	Tapa inspección distribución	NB 1	540213
2077537	Bomba de agua	NB 1	540314
2214826	Múltiple escape	NFT 1	540315
2068824	Múltiple admisión	NFT 1	540217
2068331	Junta termostato	CB 1	220119
2215063	Salida de escape	FCH 1	540318
	Jgo. juntas carburador carter c/separador	VS	540320
	Jgo. juntas carburador carter s/separador	VS	540321
2096382	Jgo. juntas carburador Weber 45DCDE	VS	540222
2069022	Base carburador	NB 1	540225
2018961	Tapa bomba aceite	CU 1	540227
2016726	Base bomba nafta	NB 1	540028
2068331	Salida termostato	CB	540231
2018235	Base bomba aceite	NB 1	540232
	Base bomba aceite	NB 1	540332
	Arandelas tapa válvulas	GS 4	540333
2017354	Tapa diferencial - Dana 44	CG	540034
2077537	Bomba de agua	CB	540334
	Separador carburador CARTER ABD		540335
	Vaso bomba nafta	CG 1	540041
2019532	Jgo. juntas empaquetadura bancada (2)	SNA 1	540258
2017354	Tapa diferencial - Dana 44	CGT	540068
2086863	O'ring conducto aceite a distr. G 12.29 x 3.53	GS 2	540269
2017354	Tapa diferencial - Dana 44	NB	300086
	Kit de retenes completo		R540200
	Jgo. retén válvulas (12)	P 1	R540210P
	Retén distribución 52.38 x 81.02 x 11	P 1	R540012P

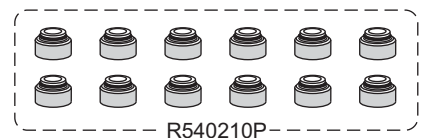
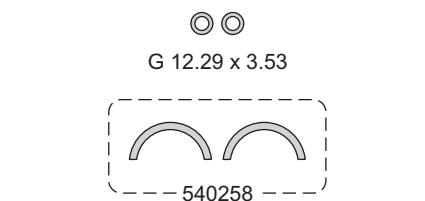
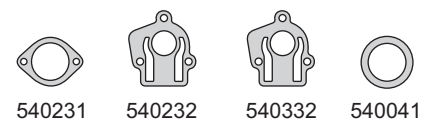
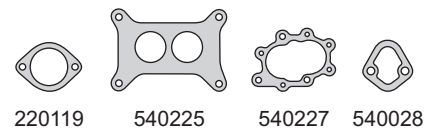
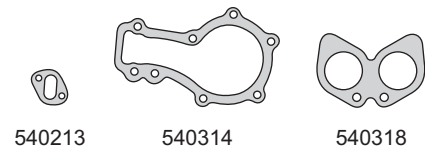
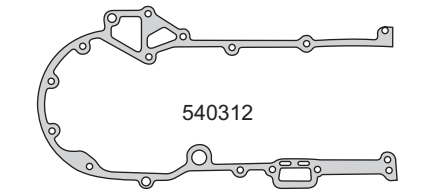
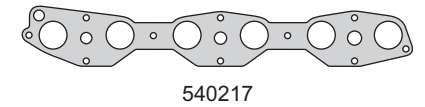
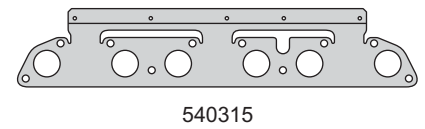
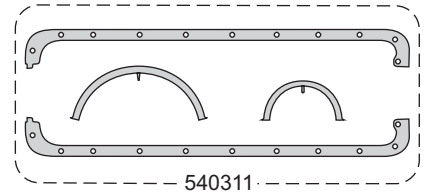
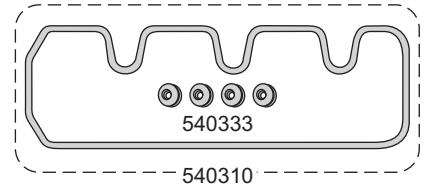
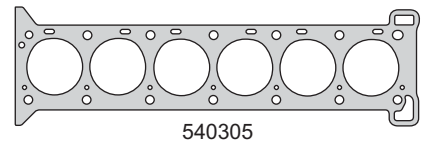

IKA



Motor/Engine **OHC 181/230/300** Cm³ **2966** HP **140/160** Ø **84.94**

Ika: Rambler - Torino Tornado 300SL
Gladiator 1966/73



Nº OE	Descripción/Description	Mat.	Ref.
	Jgo. de juntas para motor		540400-R
2069497	Junta tapa cilindros Ø 87.5 ±1.40	NFT	1 540205
2019161	Conj. junta tapa válvulas (5)	GS	1 540210
2093746	Jgo. junta para cárter (4)	CG	1 540211
2069554	Tapa distribución	NB	1 540212
2017031	Tapa inspección distribución	NB	1 540213
2017008	Tapa bomba de agua	NB	1 540214
2069066	Múltiple escape	NFT	1 540216
745608	Salida de escape	FCH	1 540118
	Junta termostato	CB	1 220119
648852	Salida agua termostato	CB	2 540219
2093836	Jgo. juntas carburador cárter RBS	VS	540121
	Junta base carburador HOLLEY	NB	300025
2018041	Base carburador		540425
2018961	Tapa bomba aceite	CU	1 540227
2016726	Base bomba nafta	NB	1 540028
	Media distribución	NB	540230
2068331	Salida termostato	CB	540231
2018235	Base bomba aceite	NB	1 540232
2068764	Arandelas tapa válvulas	GS	4 540233
2017354	Tapa diferencial dana 44	CG	540034
	Junta base bomba aceite	NB	1 540332
2077537	Bomba de agua	CB	540334
	Múltiple admisión	NFT	1 540235
	Separador carburador carter ABD		540335
	Base caballete levas	NFT	540236
	Vaso bomba nafta	CG	1 540041
2019532	Jgo. juntas empaquetadura bancada (2)	SNA	1 540258
2017354	Tapa diferencial dana 44	CGT	540068
2086863	O´ring conducto aceite a distribución G 12.29 x 3.53	GS	4 540269
2017354	Tapa diferencial dana 44	NB	300086
	Kit de retenes completo		R540200
	Jgo. retén válvulas (12)	P	1 R540210P
	Retén distribución 52.38 x 81.02 x 11	P	1 R540012P

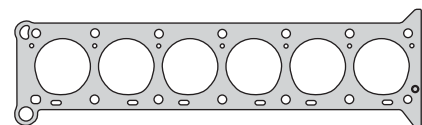

540205

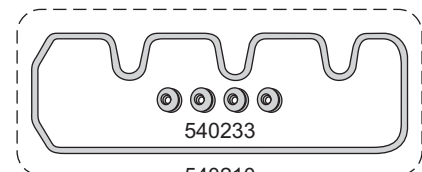

540210

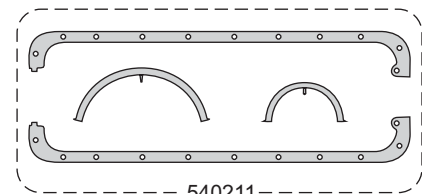

540211

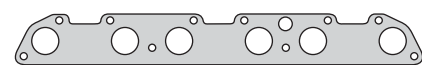

540212

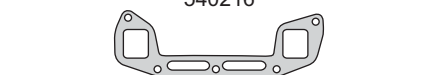

540216

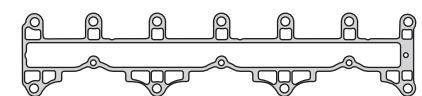

540236

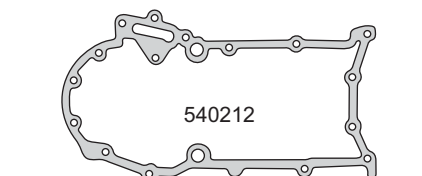

540212



540213 540214 540118



220119 540219 540425

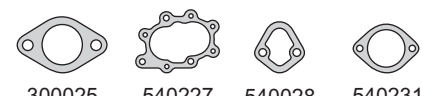

300025 540227 540028 540231

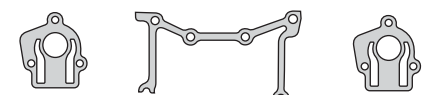

540232 540230 540332



G12.29 x 3.53 540041



540258 R540012P

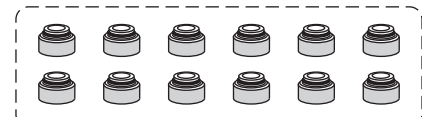

R540210P

RENAULT / IKA

IKA



Motor/Engine Cm³ HP Ø

OHC 4B **3770** **180** **84.94**

Ika: Torino Tornado Reforma 1972/74



RENAULT / IKA

Nº OE	Descripción/Description	Mat.	Ref.
	Jgo. de juntas para motor		540500-R
2069497	Junta tapa cilindros Ø 87.5 ±1.40	NFT	1 540205
2019161	Conj. junta tapa válvulas (5)	GS	1 540210
2098986	Jgo. junta para cárter (4)	CG	1 540311
2077747	Tapa distribución	NB	1 540312
2017031	Tapa inspección distribución	NB	1 540213
2077537	Bomba de agua	NB	1 540314
2214826	Múltiple escape	NFT	1 540315
2068824	Múltiple admisión	NFT	1 540217
2058422	Salida de escape	FCH	1 540218
	Junta termostato	CB	1 220119
	Junta base carburador	NB	1 540225
2018961	Tapa bomba aceite	CU	1 540227
2016726	Base bomba nafta	NB	1 540028
2068331	Salida termostato	CB	540231
2018235	Base bomba aceite	NB	1 540232
	Base bomba aceite	NB	1 540332
	Arandelas tapa válvulas	GS	4 540233
2017354	Tapa diferencial dana 44	CG	540034
2077537	Bomba de agua	CB	540334
	Vaso bomba nafta	CG	1 540041
2019532	Jgo. juntas empaquetadura bancada (2)	SNA	1 540258
2017354	Tapa diferencial dana 44	CGT	540068
2086863	O ring conducto aceite a distr. G 12.29 x 3.53	GS	2 540269
	Tapa diferencial dana 44	NB	300086
	Kit de retenes completo		R540200
	Jgo. retén válvulas (12)	P	1 R540210P
	Retén distribución 52.38 x 81.02 x 11	P	1 R540012P

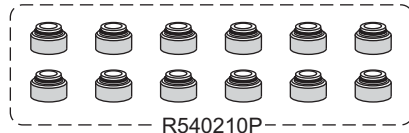
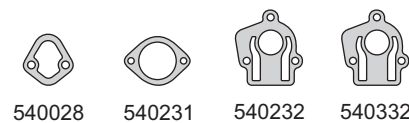
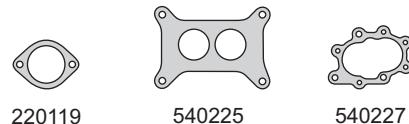
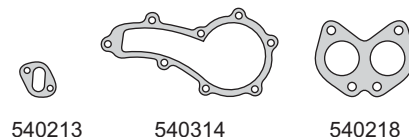
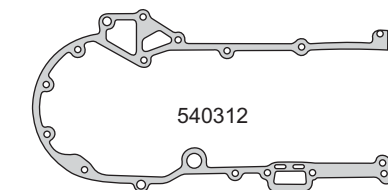
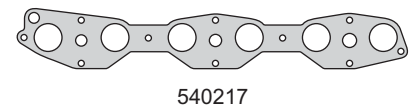
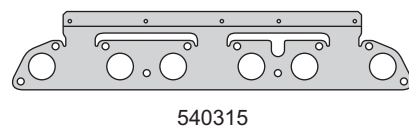
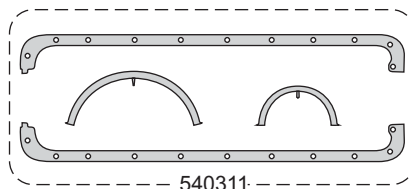
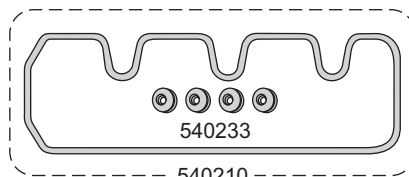
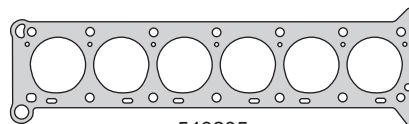

RENAULT



Motor/Engine	Cm³	HP	Ø
670-04/05	845		58

Renault: Gordini - Floride - Dauphine 4L - 4F
1960/64



Nº OE	Descripción/Description	Mat.	Ref.
9803903	Jgo. de juntas para motor		55000-R
5544952	Junta tapa cilindros Ø 59 \pm 1.40	NFT	1 550005
5544952	Junta tapa cilindros Ø 59 \pm 2.40	NFT	550006
5540379	Junta tapa válvulas superior	CG	1 550010
4261399	Jgo. junta para cárter (6)	CG	1 550011
4261155	Tapa distribución	CG	1 550012
4261156	Placa distribución	CB	1 550013
6030957	Tapa bomba de agua	NB	1 550014
6069482	Jgo. múltiple admisión y escape DAUPH (2)	NFT	1 550016
6066788	Jgo. múltiple admisión y escape GORD (2)	NFT	1 550116
6069546	Bomba de agua a block	NB	1 550019
8548582	Jgo. juntas carburador SOLEX 28 IBT	VS	550020
	Jgo. juntas carburador SOLEX 28 IDT	VS	550021
	Jgo. juntas carburador SOLEX 32 PIBT	VS	550122
949938	Jgo. juntas carburador cárter RBS	VS	550222
6061372	Base carburador IBT	NB	1 550025
1032068	Base carburador RBS	NB	550225
6027824	Bomba aceite	NB	1 550027
6028670	Bomba nafta	NB	1 550028
6023496	Bomba nafta a block	NB	1 550428
6051531	Entre múltiples	NFT	1 550034
6038375	Caño bomba agua	NB	1 550036
8540067	Cuerpo bomba nafta	CG	450037
6042349	Cámara agua a tapa cilindros	CB	1 550039
7062434	Boca carga aceite	CG	450041
8513050	Vaso bomba combustible	CG	1 540041
9807295	Jgo. juntas caja velocidades	VS	550050
	Jgo. juntas para cárter	CGT	550060
6051846	Jgo. suplemento camisa cilindros (0.90) VE	CU	550070-0.90
6051845	Jgo. suplemento camisa cilindros (0.95) AM	CU	550070-0.95
6066250	Jgo. suplemento camisa cilindros (1.00) AZ	CU	550070-1.00
7109306	Jgo. suplemento camisa cilindros (1.05) BL	CU	550070-1.05
	Jgo. suplemento camisa cilindros (1.10) RO	CU	550070-1.10
	Jgo. suplemento camisa cilindros (0.10)	CU	550070-0.10
	Jgo. suplemento camisa cilindros (0.20)	CU	550070-0.20
	Jgo. suplemento camisa cilindros (0.30)	CU	550070-0.30
	Jgo. suplemento camisa cilindros (0.50)	CU	550070-0.50
	O'ring G 4.34 x 3.53	GS	8
	Retén distribución 32 x 50 x 10	N	1 R550012N

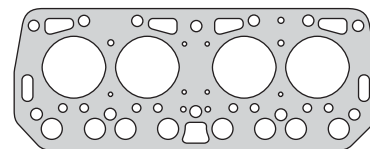

550005

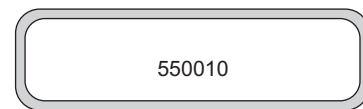

550010

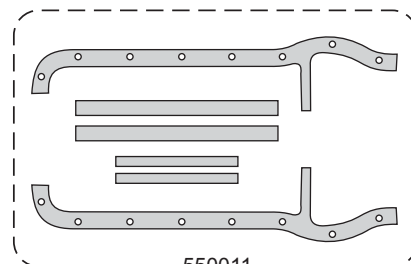

550011

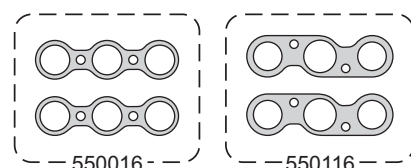

550016

550116

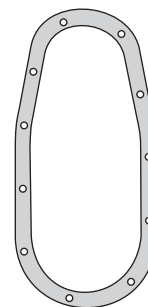

550012

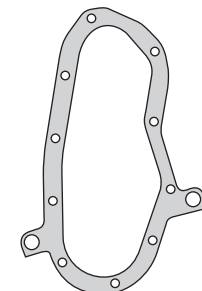

550013



550014

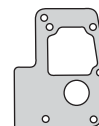

550019



550025

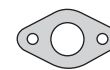

550225



550027



550028



550428



550034



550036



450037



550039



450041



G 4.34 x 3.53



540041



R550012N

RENAULT



Motor/Engine	Cm³	HP	Ø
688.01/10-810.88	1289	54	73

Renault: R12 - R4L - 4S - R6 - R4 1970/...
R12TS - R15 1972/75



RENAULT / IKA

Nº OE	Descripción/Description	Mat.	Ref.
7700509107	Jgo. de juntas para motor		550400-R
7700509107	Jgo. de juntas superior		550495
7700509107	Jta. tapa cilindros Ø 74 \pm 1.40	NFT 1 1	550405
7702220551	Jta. tapa cilindros Ø 74 \pm 2.40	NFT	550406
1018413	Jta. tapa cilindros Ø 74 \pm 1.40	NFT	550407
1018413	Jgo. tornillos tapa cilindros (HAS17038)		B550400
7702057213	Conj. junta tapa válvulas superior (4)	N 1 1	550410
7700513014	Jgo. junta para cárter (4)	CG 1	550411
7702020652	Tapa distribución	NB	550312
7702057848	Tapa distribución	CG 1	550412
7702057848	Tapa bomba de agua R 6	NB 1 1	550314
	Tapa bomba de agua	NB 1 1	550414
7700513015	Múltiple admisión y escape	FCH 1	550415
7702020651	Múltiple admisión y escape	NFT 1	550416
	Salida de escape	FCH 1 1	550418
7701003167	Bomba de agua a block R 6	NB 1 1	550319
770202836	Placa bomba de agua	NB 1 1	550419
7701008701	Jgo. juntas carburador SOLEX 28 IBS	VS	550220
7701013761	Jgo. juntas carburador SOLEX F 32 PDIS 3	VS	550320
0855253900	Jgo. juntas carburador WEBER 30 ICF	VS	550221
7700524853	Jgo. juntas carburador SOLEX 32 EISA 3	VS	550421
7702023149	Jgo. juntas carburador WEBER 32 DIR 21	VS	550521
0857726400	Base carburador	NB 1 1	550325
7702023292	Base carburador	NB 1 1	550425
7703061078	Base carburador 2B	NB 1	550525
7704000287	Toma y tapa bomba aceite	NB 1	550427
0857714400	Base bomba nafta	NB 2	550428
7700513014	Arandela tapa válvulas A 7 x 17 x 1.5 F	NB 3 3	550430
7702020652	Tapa cámara agua trasera	NB 1 1	550331
0607155200	Tapa cámara agua trasera	NB 1 1	550332
0555497400	Tapa bomba de agua R 6		550334
7702053261	Tapa bomba de agua R 12		550434
6071557	Bomba aceite a block	NB 1	550435
	Junta tapa válvulas superior	CG	550436
	Tapa bomba nafta	NB	550437
	Base distribuidor	NB 1	550338
7700513015	Bomba de agua a block		550339
7702020651	Placa bomba de agua	CB	550439
	Tapa llenado de aceite	CG 1 1	450041
	Jgo. juntas caja velocidades	CB	550350
1018413	Jgo. junta para cárter	CGT	550460
	Jgo. suplemento camisa cilindros (0.08) AZ (4)	CU	550470-0.08
	Jgo. suplemento camisa cilindros (0.10) RO (4)	CU 1	550470-0.10
	Jgo. suplemento camisa cilindros (0.12) VE (4)	CU	550470-0.12
1018413	Junta para cárter	ACO	550482
	Arandela tapón carter A 16 x 22 x 1A	AL	
	Kit de retenes completo		R550400
	Jgo. retén válvulas (8)	P 1	R550410P
	Retén bancada 70 x 90 x 10	P 1	R550411P
	Retén bancada 80 x 100 x 13	P	R550811P
	Retén distribución 35 x 50 x 9	P 1	R550412P
	Retén árbol levas 30 x 42 x 8	P 1	R550413P

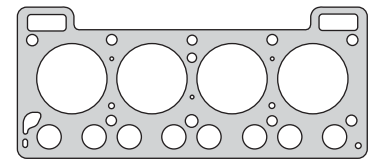

550405

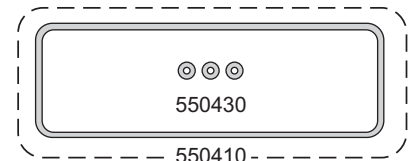

550430

550410

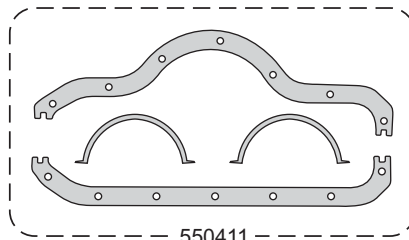

550411

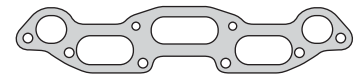

550415/550416

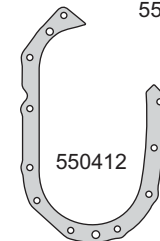

550412

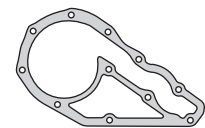

550414

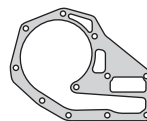

550314



550418

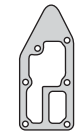

550319

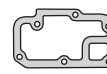

550419



550325



550427



550425



550525



550428



550331



550332



500435



550338



450041



550470-0.10



R550411P



R550811P



R550412P



R550413P

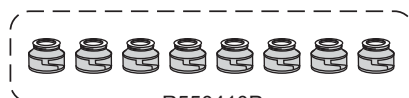

R550410P

RENAULT



Motor/Engine	Cm³	HP	Ø
847	1397	63/68	76

Renault: R12TS - R5TX 1976/80



Nº OE	Descripción/Description	Mat.	Ref.
	Jgo. de juntas para motor		550500-R
	Jgo. de juntas superior		550595
7702023675	Jta. tapa cilindros Ø 77 ± 1.40	NFT 1 1	550505
7702023675	Jta. tapa cilindros Ø 77 ± 2.40	NFT	550506
7702023675	Jta. tapa cilindros Ø 77 ± 1.20 N.R. HAS17038	NFT	550507
	Jgo. tornillos tapa cilindros (HAS17038)		B550400
7702220551	Conj. junta tapa válvulas superior (4)	N 1 1	550410
1018413	Jgo. junta para cárter	CG 1	550411
7702057213	Tapa distribución	NH	550312
7702057213	Tapa distribución	CG 1	550412
7702020652	Tapa bomba de agua	NB 1 1	550414
7702057848	Múltiple admisión y escape	FCH 1	550415
7702057848	Múltiple admisión y escape	NFT 1	550416
7702024218	Salida de escape	FCH 1 1	550418
7702020651	Placa bomba de agua	NB 1 1	550419
	Jgo. juntas carburador CARTER C-5-2055-5	VS	550420
	Jgo. juntas carburador SOLEX 34 IES	VS	550520
7701013761	Jgo. juntas carburador WEBER 32 DIR 21	VS	550521
	Jgo. juntas carburador WEBER 34 ICH	VS	550422
	Jgo. juntas carburador SOLEX 34/7 EIES	VS	550522
7702023149	Base carburador 2B	NB 1 1	550525
0857726400	Toma y tapa bomba aceite	NB	1 550427
7702023292	Base bomba nafta	NB	2 550428
7702057985	Base carburador CARTER	NB	1 550529
7703071078	Arandela tapa válvulas A 7 x 17 x 1.5 F	NB 3 3	550430
7704000287	Tapa cámara agua trasera	NB 1 1	550331
7702020652	Tapa bomba de agua		550434
0607155200	Bomba aceite a block	NB	1 550435
0555497400	Junta tapa válvulas	CG	550436
7702053261	Tapa bomba nafta	NB	550437
6071557	Base distribuidor	NB	1 550338
7702020651	Placa bomba de agua	CB	550439
	Bomba pique	NB	550540
	Llenado aceite	CG 1 1	450041
	Jgo. juntas caja velocidades	CB	550350
	Jgo. juntas caja velocidades 5ta.	CB	550450
1018413	Jgo. junta para cárter	CGT	550460
7702023663	Jgo. suplemento camisa cilindros (0.08) AZ	CU	550570-0.08
7702023664	Jgo. suplemento camisa cilindros (0.10) RO (4)	CU 1	550570-0.10
7702023665	Jgo. suplemento camisa cilindros (0.12) VE	CU	550570-0.12
1018413	Junta para cárter	ACO	550482
	Arandela tapón cárter A 16 x 22 x 1A	AL	
	Kit de retenes completo		R550500
	Jgo. retén válvulas (8)	T	R550910T
	Jgo. retén válvulas (8)	V 1	R550910V
	Retén bancada 70 x 90 x 10	P 1	R550411P
	Retén distribución 35 x 50 x 9	P 1	R550412P
	Retén árbol levas 30 x 42 x 8	P 1	R550413P

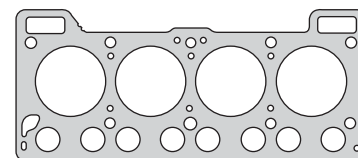

550505

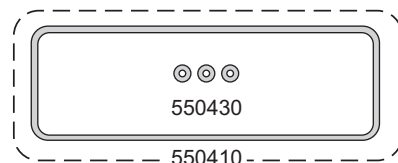

550430

550410

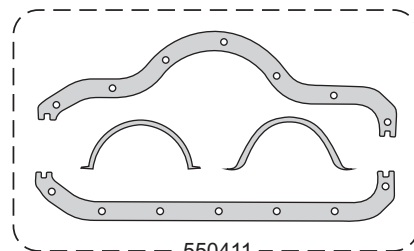

550411



550415/550416



550412

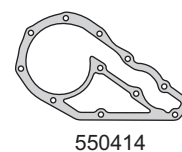

550414



550418

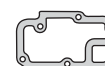

550419

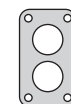

550525



550427



550529



550331



550338



550428



550435



450041



550570-0.10



R550411P



R550412P



R550413P



R550910V

RENAULT / KA

RENAULT



Motor/Engine	Cm³	HP	Ø
J5R	1995	80/102	88
829-J5R/6R/7R	1995	102/120	88
851-J7T	2165	95/120	88

Jeep: Wrangler 1983/86
Renault: Master 1981/93 - R18 - Fuego 1981/86
 Trafic - R21/25 83/94 - Espace 1984/97
 R20 1977/84 - Trafic 1989/...



RENAULT / IKA

Nº OE	Descripción/Description	Mat.	1	2	Ref.
	Jgo. de juntas para motor				550600-R
	Jgo. de juntas superior				550695
7700720788	Junta tapa cilindros Ø 89 ± 1.40	NFT	1	1	550605
7700720788	Junta tapa cilindros Ø 89 ± 2.40	NFT			550606
7700720788	Junta tapa cilindros Ø 89 ± 1.20	NFT			550607
	Jgo. tornillos tapa cilindros (HAS19038)				B550600
	Jgo. tornillos tapa cilindros (HAS19038)				B550600-1
7700614729	Conj. juntas tapa válvulas (4)	GS	1	1	550610
7702057744	Junta para cárter	CG		1	550611
7700655572	Eje intermedio distribución	NB		1	550613
	Bomba de agua	NB		1	550614
7700622286	Múltiple escape	NFT	1	1	550616
7700622284	Jgo. múltiple admisión (4)	NB	1	1	550617
7700679861	Salida de escape	FCH	1	1	550618
7700623392	Bomba de agua a block	NB		1	550619
7702073137	Jgo. juntas carburador WEBER 32/36 DARA	VS			550620
	Jgo. juntas carburador WEBER 32/32 DARA	VS			550621
	Jgo. juntas carburador SOLEX 34 TEIE	VS			550622
	Jgo. juntas carb. HOLLEY RX 7040A TRAFFIE	VS			550623
0608201900	Base carburador	NB	1	1	550625
	Base bomba aceite	NB		1	550627
7700622283	Base bomba nafta	NB		2	550628
0313.030	Arandela tapón cárter B18 x 24 x 2.3 CN	CN			450029
	Jgo. admisión inyección (4)	NB	1	1	550629
7703061078	Arandela tapa válvulas A 8 x 18 x 1.5	NB	3	3	550630
7702073139	Filtro aire	CG		1	550631
7704000276	Cámara agua tapa cilindros	NB	1	1	550632
7700629742	Anillo o'ring base distribución G 39 x 3	GS	1	1	550633
7700623393	Cuerpo bomba agua	NB		1	550634
	O'ring tapón block mando b/ac. 47.3 x 2	GS			550638
	Termostato	NB	1	1	550639
	Llenado de aceite	CG	1	1	450041
	Anillo termostato	GS	1	1	550641
	Jgo. juntas caja velocidades	VS			550650
	Jgo. cierre bancada (4)	GS		1	550658
7700591167	Junta para cárter	CGT			550660
	Jgo. suplemento camisa cilindros (4)	GS		1	550670
7700618961	Junta para cárter	ACO			550682
	Arandela tapón cárter A 18 x 24 x 1.5 A	AL		1	
	Kit de retenes completo				R550600
	Jgo. retén válvulas (8)	P		1	R550610P
	Retén bancada 90 x 110 x 13	P		1	R550611P
	Retén distribución 50 x 68 x 10	P		1	R550612P
	Retén árbol levas 35 x 47 x 7	P		1	R550613P
	Retén auxiliar 30 x 40 x 7	P		1	R550615P

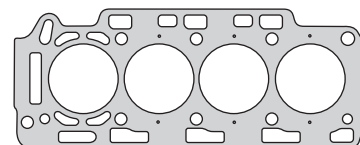

550605

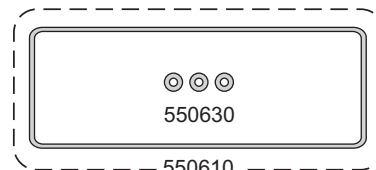

550630

550610

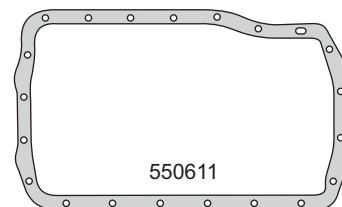

550611

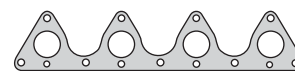

550616

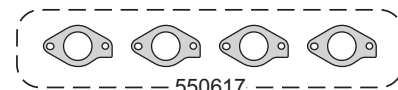

550617



550629

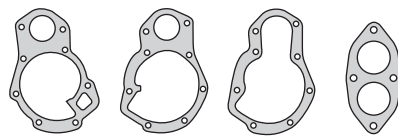

550614 550619 550634 550618

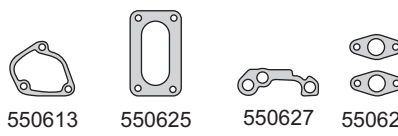

550613 550625 550627 550628

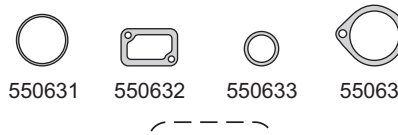

550631 550632 550633 550639

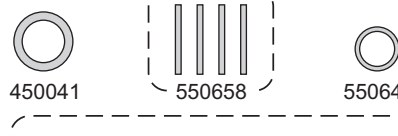

450041 550658 550641

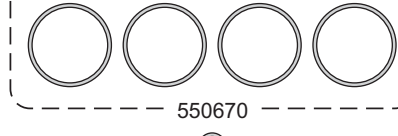

550670

A 18 x 24 x 1.5 A



R550611P



R550612P R550613P R550615P

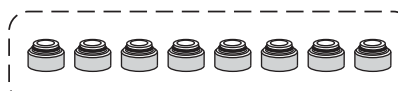

R550610P

RENAULT



Motor/Engine	Cm³	HP	Ø
C1J/C2J	1397	60/67	76
C1J/C2J Turbo	1397	104/110	76

Renault: R9 1981/89 - R11 1983/89 - R19 - R21 1988/93 - Super Cinco 1985/93



Nº OE	Descripción/Description	Mat.	Ref.
	Jgo. de juntas para motor		550700-R
	Jgo. de juntas superior		550795
7702080611	Junta tapa cilindros Ø 77 \pm 1.40	NFT 1 1	550705
7702080611	Junta tapa cilindros Ø 77 \pm 1.20 N.R.	NFT	550707
	Jgo. tornillos tapa cilindros (HAS17038)		B550400
7702220779	Conj. junta tapa válvulas (4)	N 1 1	550710
7702070195	Jgo. junta para cárter (4)	CG 1	550711
7702070195	Jgo. junta para cárter	NB	550811
7702057213	Tapa distribución	NB	550312
7702057213	Tapa distribución	CG 1	550412
7701349269	Bomba de agua	NB 1 1	550714
	Múltiple admisión y escape	FCH 1	550715
7700697874	Múltiple admisión y escape	NFT 1	550716
	Múltiple admisión y escape	NFT	550816
7702080617	Placa bomba de agua	NB 1 1	550719
	Jgo. juntas carburador WEBER 32 DTR 2	VS	550720
7701201752	Jgo. juntas carburador SOLEX 32 B	VS	550721
	Base carburador 1B	NB 1 1	550725
0857726400	Toma y tapa aceite	NB 1	550427
7702023292	Bomba nafta	NB 2	550428
	Bomba nafta	NB 1	550528
	Bomba nafta block		550728
	Bulbo temperatura A 22 x 32 x 1.5 F	NB 1	550929
7703061078	Arandela tapa válvulas A 7 x 17 x 1.5 F	NB 3 3	550430
7704000287	Tapa cámara agua trasera	NB 1 1	550331
0607155200	Cuerpo bomba aceite	NB 1	550435
7702053261	Tapa bomba nafta	NB	550437
6071557	Base distribuidor	NB 1	550338
	Base carburador 2B	NB 1 1	550738
	Llenado aceite	CG 1 1	450041
	Jgo. juntas caja velocidades	GS	550750
7702070195	Jgo. junta para cárter	CGT	550760
7701348178	Jgo. suplemento camisa cilindros (4)	GS 1	550671
7702070195	Junta para cárter	ACO	550782
	Arandela tapón cárter A 16 x 22 x 1A	AL	
	Kit de retenes completo		R550700
	Jgo. retén válvulas (8)	T	R550910T
	Jgo. retén válvulas (8)	V 1	R550910V
	Retén bancada 80 x 100 x 13	P 1	R550811P
	Retén distribución 35 x 50 x 9	P 1	R550412P
	Retén árbol levas 30 x 42 x 8	P 1	R550413P

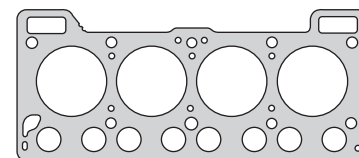

550705

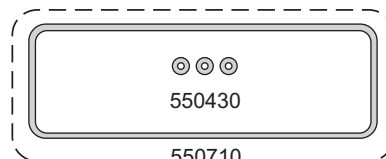

550430

550710

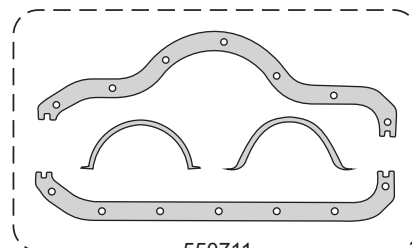

550711



550715

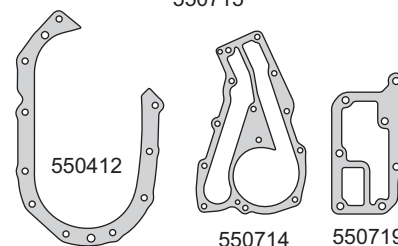

550412

550714

550719

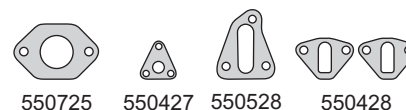

550725

550427

550528

550428



550331

550435

550738

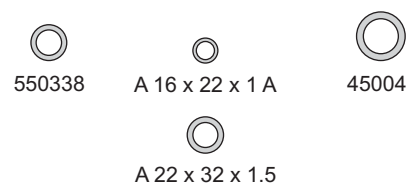

550338

A 16 x 22 x 1 A

450041

A 22 x 32 x 1.5



550671

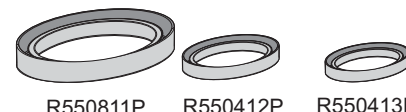

R550811P

R550412P

R550413P



R550910V



R550910T

RENAULT / KA

RENAULT



Motor/Engine	Cm³	HP	Ø
847	1397	48	76

Renault: 12 - 18 - Junior - Trafic 1982/...



RENAULT / IKA

Nº OE	Descripción/Description	Mat.	Ref.
	Jgo. de juntas para motor		550800-R
	Jgo. de juntas superior		550895
7702080611	Junta tapa cilindros Ø 77 ± 1.40	NFT 1 1	550705
7702080611	Junta tapa cilindros Ø 77 ± 1.20	NFT	550707
	Jgo. tornillos tapa cilindros (HAS17038)		B550400
0555497400	Conj. junta tapa válvulas superior (4)	GS 1 1	550410
7702070195	Jgo. junta para cárter (4)	CG 1	550711
7702070195	Jgo. junta para cárter	NH	550811
7702057213	Tapa distribución	NH	550312
7702057213	Tapa distribución	CG 1	550412
	Tapa bomba de agua	NB 1 1	550314
7702020652	Tapa bomba de agua	NB 1 1	550414
7702057848	Múltiple admisión y escape	FCH 1	550415
7702057848	Múltiple admisión y escape	NFT 1	550416
7702024218	Salida de escape	FCH 1	550418
7702057996	Salida de escape 18 Junior	FCH 1 1	550818
7702020651	Placa bomba de agua	NB 1 1	550419
	Jgo. juntas carburador CARTER C5-2055-5	VS	550420
	Jgo. juntas carburador WEBER 30 ICF	VS	550820
7701013761	Jgo. juntas carburador WEBER 32 DIR 21	VS	550521
	carburador Solex Argelite	VS	550821
	Jgo. juntas carburador WEBER 34 ICH	VS	550422
	Jgo. juntas carburador SOLEX 34/7 EIES	VS	550522
7702023149	Base carburador 2B	NB 1 1	550525
	Base carburador WEBER TRAFIC	NB	550825
0857726400	Toma y tapa bomba ace	NB 1	550427
7702023292	Base bomba nafta	NB 2	550428
7702057895	Bomba nafta	NB 1	550528
	Base bomba nafta a block		550728
7702057985	Base carburador cárter	NB 1 1	550529
	Bulbo temperatura A 22 x 32 x 1.5 F	NB 1	550929
7703061078	Arandela tapa válvulas A 7 x 17 x 1.5 F	NB 3 3	550430
7704000287	Tapa cámara agua trasera	NB 1 1	550331
0857714400	Tapa cámara agua trasera	NB 1 1	550332
0607155200	Cuerpo bomba aceite	NB 1	550435
	Arandela tapón cárter A 16 x 22 x 1 C	CU	550835
	Tubo llenado	CG 1	450041
	Jgo. juntas caja velocidades	CB	550350
	Jgo. juntas caja velocidades 5ta.	CB	550450
	Jgo. juntas caja velocidades	VS	550650
7702070195	Jgo. junta para cárter	CGT	550760
7701348178	Jgo. suplemento camisas cilindros (4)	GS 1	550671
7702070195	Junta para cárter	ACO	550782
	Kit de retenes completo		R550700
	Jgo. retén válvulas (8)	T	R550910T
	Jgo. retén válvulas (8)	V 1	R550910V
	Retén bancada 80 x 100 x 13	P 1	R550811P
	Retén distribución 35 x 50 x 9	P 1	R550412P
	Retén árbol levas 30 x 42 x 8	P 1	R550413P

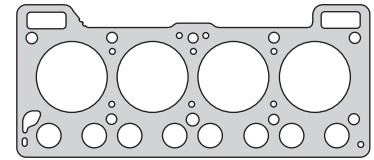

550705

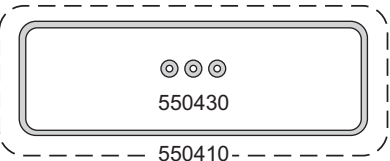

550430

550410-

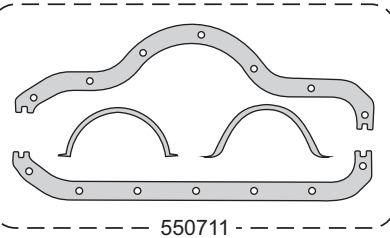

550711-

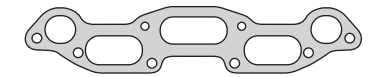

550415/550416

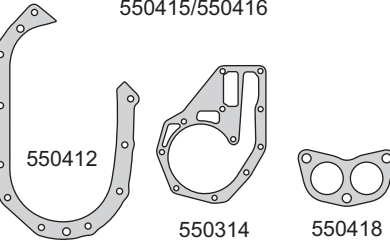

550412

550314

550418

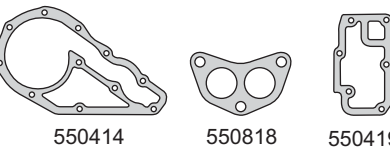

550414

550818

550419

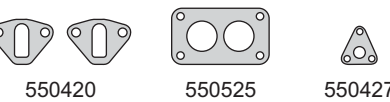

550420

550525

550427

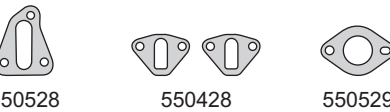

550528

550428

550529

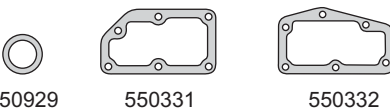

550929

550331

550332



550835

550435

450041

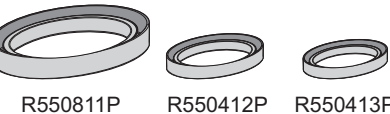

R550811P

R550412P

R550413P

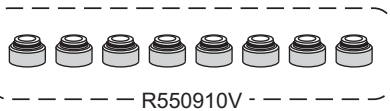

R550910V

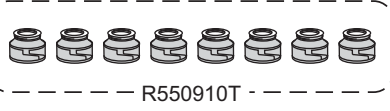

R550910T

RENAULT



Motor/Engine Cm³ HP Ø

C1L - C2L
Carburador **1565** **77**

Renault: R9 - R11 - R12 - R18 - R19 1988/...



Nº OE	Descripción/Description	Mat.			Ref.
	Jgo. de juntas para motor				550900-R
	Jgo. de juntas superior		●		550995
	Jgo. de juntas superior				550997
	Junta tapa cilindros Ø 78 \pm 1.40	NFT	1	1	550905
	Junta tapa cilindros Ø 78 \pm 2.40	NFT			550906
	Junta tapa cilindros Ø 78 \pm 1.20 N.R.®	NFT			550907
	Jgo. tornillos tapa cilindros (HAS17038)				B550400
7702220551	Conj. junta tapa válvulas (4)	GS	1	1	550710
7702206018	Jgo. junta para cárter (4)	CG		1	550911
7702057213	Tapa distribución	CG		1	550412
7701349269	Bomba de agua	NB	1	1	550714
770205848	Múltiple admisión y escape	FCH		1	550415
	Múltiple escape	FCH		1	550815
7702057848	Múltiple admisión y escape	NFT	1		550416
	Múltiple escape	NFT	1		550816
7702057929	Salida de escape	FCH	1	1	550818
7702080617	Placa bomba de agua	NB	1	1	550719
	Jgo. juntas carburador WEBER 32 DTR	VS			550920
	Jgo. carburador SOLEX 32 bis	VS			550921
0608201900	Base carburador	NB	2	2	550625
	Base carburador SOLEX BAS	NB			550725
	Base carburador WEBER				550925
7702057895	Base bomba nafta	NB		2	550528
	Bulbo temperatura A 22 x 32 x 1.5 F	NB		1	550929
7703061078	Arandela tapa válvulas A 7 x 17 x 1.5 F	NB	3	3	550430
	Tapón cárter A 16 x 22 x 1 C	CU		1	550930
7704000287	Tapa cámara agua trasera	NB	1	1	550331
0857714400	Tapa cámara agua	NB	1	1	550332
	Base bomba aceite	NB		1	550935
770079807	Unión caño escape	AC			550940
7702020130	Tapa carga aceite	CG	1	1	450041
7702206018	Jgo. junta para cárter	CGT			550960
7701348178	Jgo. suplemento camisa cilindros (4)	GS		1	550671
7702206018	Junta para cárter	ACO			550982
	Kit de retenes completo				R550900
	Jgo. retén válvulas (8)	T			R550910T
	Jgo. retén válvulas (8)	V		1	R550910V
	Retén bancada 80 x 100 x 13	P		1	R550811P
	Retén distribución 35 x 50 x 9	P		1	R550412P
	Retén árbol levas 30 x 42 x 8	P			R550413P

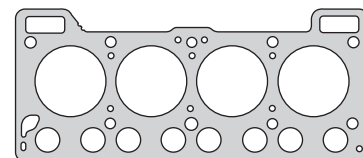

550905

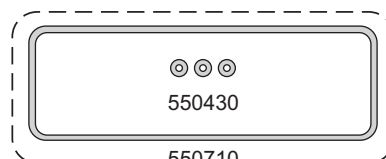

550430

550710

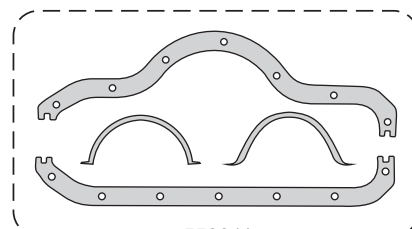

550911



550415/550416

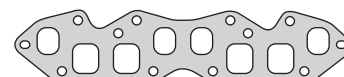

550815/550816

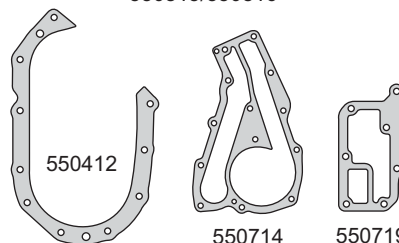

550412

550714

550719

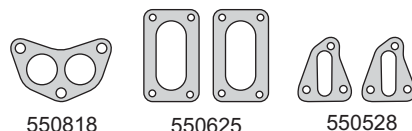

550818

550625

550528



550925

550929

550930

450041

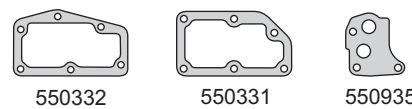

550332

550331

550935



550671

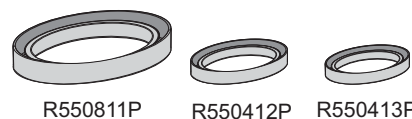

R550811P

R550412P

R550413P

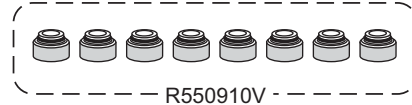

R550910V



R550910T

RENAULT / KA

RENAULT



Motor/Engine	Cm³	HP	Ø
852/J8S	2068	65/86	86
121	2068	80	86

Jeep: Jeep Wagoneer TD 1984/95
Comanche TD 1986/88
Renault: R18 1981/86 - R21 1984/97
Trafic 1981/97 - Master 1981/97

DIESEL



Nº OE	Descripción/Description	Mat.	Ref.
	Jgo. de juntas para motor		560001-R
	Jgo. de juntas superior	●	560095-1M
	Jgo. de juntas superior		560095-2M
	Jgo. de juntas superior		560095-3M
7700711666	Junta tapa cilindros Ø 87 \pm 1.70	NFT 1	560007-1M
7701035217	Junta tapa cilindros Ø 87 \pm 1.60	NFT	560007-2M
7701035218	Junta tapa cilindros Ø 87 \pm 1.80	NFT	560007-3M
	Jgo. tornillo (HAH10055/HAS19038/HAE18038)		B560000
7700662455	Junta tapa válvulas	NFT 1 1	560010
7702057744	Junta para cárter	CG 1	550611
7700655572	Eje intermedio distribución	NB 1	550613
7700735848	Bomba de agua	NB 1	560014
7700663686	Múltiple admisión y escape	NFT 1	560015
7700663686	Múltiple admisión y escape	NFT 1	560016
7702057929	Salida de escape	FCH 1 1	550618
7700684487	Base termostato	NB 1 1	560019
	Base bomba aceite	NB 1	550627
7700622283	Bomba combustible	NB 2	550628
	Arandela bulbos temperatura B 16 x 22 x 2.4 CN	CN	450029
7700733513	Termostato	NB 1 1	560029
7700735847	Salida bomba de agua	NB 1	560030
7700629742	O ring sellador G 39 x 3	GS 1	550633
7703062013	Arandela tapón cárter A 18 x 23 x 1 C	CU 1	560034
7700663363	Arandela inyector A 14.5 x 21 x 2 C	CU 4 4	560035
	Arandela parallamas	AC 4 4	560036
7703065067	O ring placa distribución G 45 x 2.5	GS 1	560037
7703065091	O ring bomba aceite G 47.35 x 1.78	GS 1	560038
7703065090	O ring termostato G 63.09 x 3.53	GS 1 1	560039
7700684487	Codo salida agua	NB 1 1	560041
	Jgo. juntas caja velocidades	VS	560050
7701030255	Jgo. cierre bancadas (4)	GS 1	550658
7702057744	Junta para cárter	CGT	550660
7700666025	Jgo. suplemento camisa cilindros inferior (4)	GS 1	560070
7700850660	Jgo. suplemento camisa cilindro (4)	GS 1	550670
	O ring G 13.94 x 2.62	GS 1	
	Arandela A 16 x 22 x 1.5 A	AL 4	
	Kit de retenes completo		R550600
	Jgo. retén válvulas (8)	P 1	R550610P
	Retén bancada 90 x 110 x 13	P 1	R550611P
	Retén distribución 50 x 68 x 10	P 1	R550612P
	Retén árbol levas 35 x 47 x 7	P 1	R550613P
	Retén auxiliar 30 x 40 x 7	P 1	R550615P

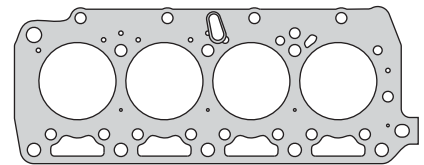

560007

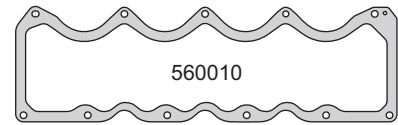

560010

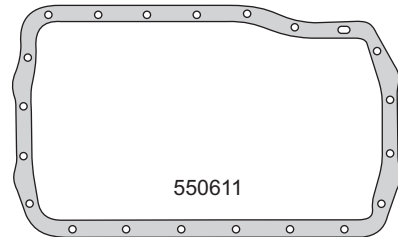

550611

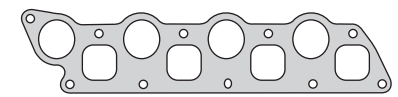

560015/560016



550613

560014

560618

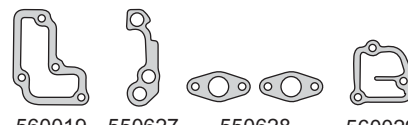

560019

550627

550628

560029



560030

G 63.09 x 3.53

560041



A 18 x 23 x 1 C

G 13.94 x 2.62

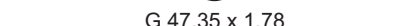

G 47.35 x 1.78



A 14.5 x 21 x 2 C



A 16 x 22 x 1.5 A

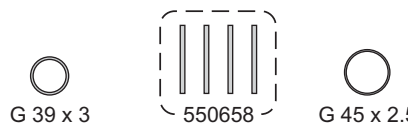

G 39 x 3

550658

G 45 x 2.5



560670



R550611P



R550612P



R550613P



R550615P

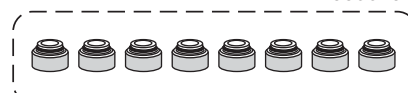

R550610P

RENAULT



Motor/Engine **F2N - F3N** Cm³ **1721** HP **75/92** Ø **81**

Renault: R19 1989/95 - R11 1986/89
Clio 1990/93 - R21 - Trafic - Super Cinco 1986/94



Nº OE	Descripción/Description	Mat.	1	1	Ref.
	Jgo. de juntas para motor		●	●	560100-R
	Jgo. de juntas superior		●		560195
7700713860	Jta. tapa cilindros Ø 81.7 ± 1.20	NFT	1	1	560107
	Jgo. tornillos tapa cilindros (HAE14038)				B560600
	Jgo. tornillos tapa cilindros (HAE14038)				B560600-1
7700743903	Conj. junta tapa válvulas (4)	N	1	1	560110
7700859751	Junta para cárter	NFT		1	560111
7700851213	Tapa bomba de agua	CB		1	560114
7700854867	Múltiple admisión y escape	FCH	1	1	560115
7700852434	Inferior árbol de levas	NB	1	1	560119
770062283	Bomba nafta	NB		2	550628
	Arandela tapa bujía B 18 x 24 x 2.3 CN	CN			450029
7700736647	O'ring G 31.5 x 3.2	GS		1	560129
	Arandela tapa bujía B 16 x 22 x 2.4 CN	CN			450229
7703061078	Arandela tapa válvulas A 7 x 17 x 1.5 F	NB	3	3	550430
7700718380	Anillo termostato	GS	1	1	560131
	Guarnición sintético G 65 x 68 x 3.6	GS		1	560132
	Guarnición sintético G 65 x 73 x 5	GS		1	560133
	Arandelas especial B 22 x 28 x 3 CN	CN			560134
	Arandelas especial B 10 x 15 x 2.4 CN	CN			560135
	Arandela especial A 14 x 20 x 2 C	CU		2	560136
	Arandela A 12 x 17 x 1 C	CU		1	560137
7701030255	Jgo. cierre bancada (4)	GS		1	550658
	Arandela A 10 x 15 x 1.5 A	AL		1	
	Arandela A 16 x 22 x 1.5 A	AL		1	
	Arandela A 18 x 24 x 1.5 A	AL		2	
	Arandela A 22 x 28 x 2 A	AL		1	
	Kit de retenes completo				R560100
	Jgo. retén válvulas (8)	V		1	R560110V
	Retén bancada 85 x 105 x 8	V		1	R560111V
	Retén distribución 50 x 68 x 10	P		1	R550612P
	Retén árbol levas 25 x 42 x 7	V		1	R560113V
	Retén auxiliar 22 x 45 x 7	P		1	R560114P
	Retén auxiliar 30 x 40 x 7	P		1	R550615P

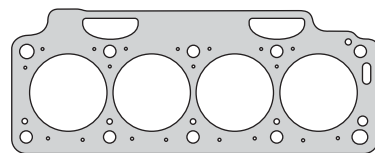

560107

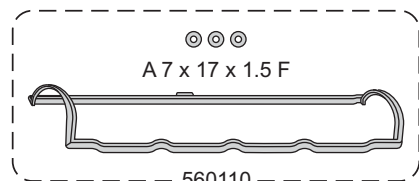

560110

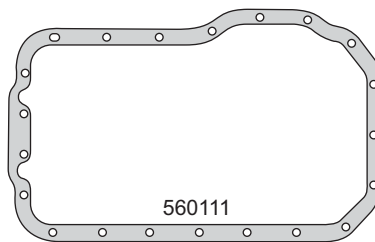

560111

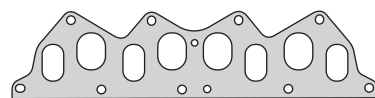

560115

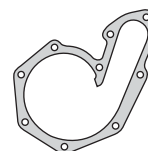

560114



560119



560131



550628



G 31.5 x 3.2



A 18 x 24 x 1.5 A



A 16 x 22 x 1.5 A



G 65 x 73 x 5



G 65 x 68 x 3.6



A 10 x 15 x 1.5 A



A 22 x 28 x 2 A

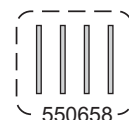

550658



R560111V



R550612P



R560113V



R560114P



R550615P

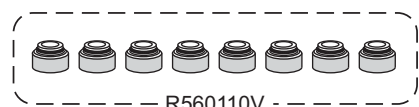

R560110V

RENAULT / K&A

DACIA



Motor/Engine	Cm³	HP	Ø
TXL	1397	60	76

Dacia: TXL 1310/1410



RENAULT / IKA

Nº OE	Descripción/Description	Mat.	Ref.
	Jgo. de juntas para motor		560200-R
	Junta tapa cilindros Ø 77 \pm 1.40	NFT 1	550505
	Junta tapa cilindros Ø 77 \pm 2.40	NFT	550506
	Junta tapa cilindros Ø 77 \pm 1.20 N.R. HAS17038	NFT	550507
	Jgo. tornillos tapa cilindros (HAS17038)		B550400
	Conj. junta tapa válvulas (4)	N 1	550410
	Jgo. junta para cárter (4)	CG 1	560211
	Tapa distribuidor	NB 1	550312
	Jta. múltiple admisión y escape	FCH 1	550415
	Tapa bomba de agua	NB 1	560214
	Salida de escape	FCH 1	550418
	Placa bomba de agua	NB 1	560219
	Carburador - Brasov-32 irm	NB	560220
	Base carburador	NB 2	560225
	Toma y tapa bomba aceite	NB 1	550427
	Base bomba nafta	NB 2	550428
	Arandela tapa válvulas A 7 x 17 x 1.5 F	NB 3	550430
	Cámara agua	NB 1	550331
	Arandela tapón cárter A 18 x 23 x 1 C	CU 1	560235
	Base bomba aceite	NB 1	550435
	Llenado aceite	CG 1	450041
	Caja velocidades	VS	560250
	Jgo. suplemento camisa cilindros (4)	S 1	550671
	Kit de retenes completo		R550900
	Jgo. retén válvulas (8)	V 1	R550910V
	Retén bancada 80 x 100 x 13	P 1	R550811P
	Retén distribución 35 x 50 x 9	P 1	R550412P

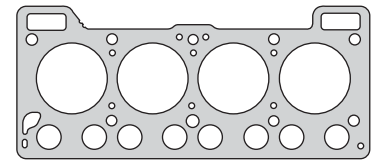

550505

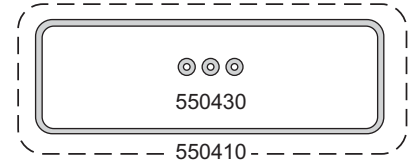

550430

550410

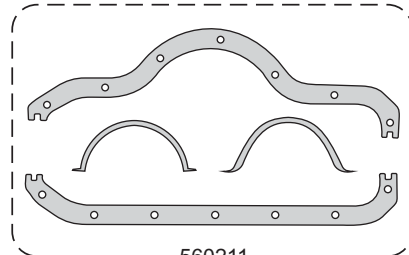

560211

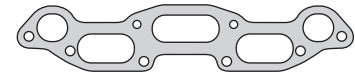

550415

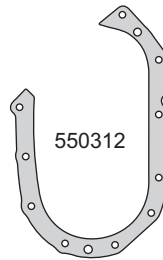

550312



560214



550418



560219



550427

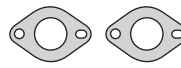

560225



550428



550435

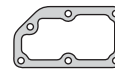

550331



450041

A 18 x 23 x 1 C



550671



R550412P



R550811P



R550910V

RENAULT



Motor/Engine	Cm³	HP	Ø
839.01 800.10	845	39	58

Renault: R5 1973/84



Nº OE	Descripción/Description	Mat.	Ref.
	Jgo. de juntas para motor		560300-R
	Junta tapa cilindros Ø 59 \pm 1.40	NFT 1	560305
	Junta tapa cilindros Ø 59 \pm 1.40	NFT	560307
	Junta tapa válvulas	CG 1	550010
	Jgo. junta para cárter (6)	CG 1	550011
	Tapa distribución	CB 1	560312
	Placa distribución	CB 1	560313
	Tapa bomba de agua	NB 1	560314
	Jgo. múltiple admisión y escape (2)	NFT 1	550016
	Placa bomba de agua	CB 1	560319
	Base carburador	NB 1	550025
	Bomba de aceite	NB 1	550027
	Bomba de nafta	NB 1	550028
	Base bomba nafta	NB 1	550428
	Entre múltiple	NFT 1	550034
	Caño agua	NB 1	550036
	Cámara de agua tapa cilindros	CB 1	550039
	Vaso nafta	CG 1	540041
	Jgo. suplemento camisa cilindros (0.90) (4)	CU	550070-0.90
6051846	Jgo. suplemento camisa cilindros (0.95) (4)	CU	550070-0.95
6051845	Jgo. suplemento camisa cilindros (1.00) (4)	CU	550070-1.00
6066250	Jgo. suplemento camisa cilindros (1.05) (4)	CU	550070-1.05
7109306	Jgo. suplemento camisa cilindros (1.10) (4)	CU	550070-1.10
	Jgo. suplemento camisa cilindros (0.10) (4)	CU	550070-0.10
	Jgo. suplemento camisa cilindros (0.20) (4)	CU 1	550070-0.20
	Jgo. suplemento camisa cilindros (0.30) (4)	CU	550070-0.30
	Jgo. suplemento camisa cilindros (0.50) (4)	CU	550070-0.50
	O´ring G 4.34 x 3.53	GS 8	
	Retén distribución 32 x 50 x 10	N 1	R550012N

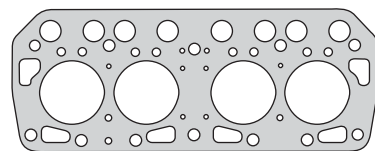

560305

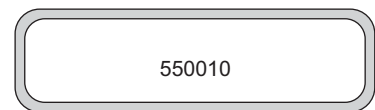

550010

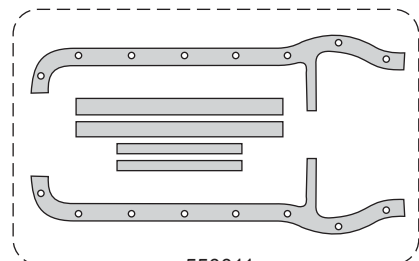

550011



550016

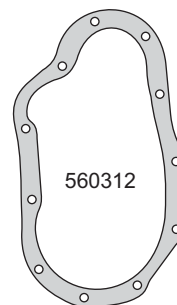

560312

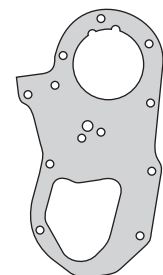

560313

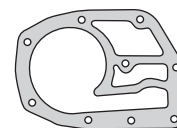

560314

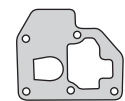

560319



550025



550027



550428



550028



550034



550036



550039



540041



G 4.34 x 3.53

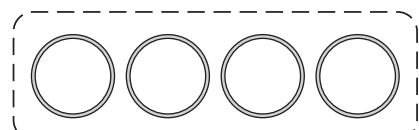

550070-0.20



R550012N

RENAULT



Motor/Engine **F3P Inyección** **Cm³** **1794** **HP** **90/96** **Ø** **82.7**

Renault: R19 - Clio - Laguna 1991/98

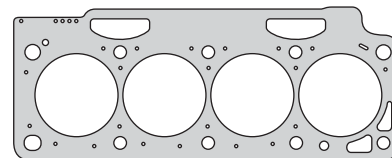

560407

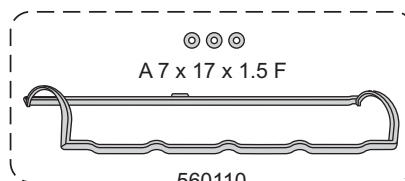

A 7 x 17 x 1.5 F

560110

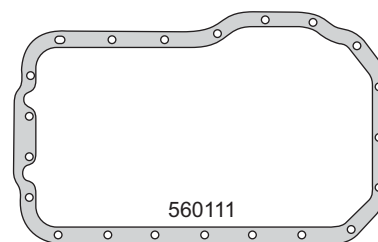

560111

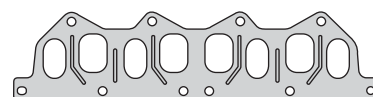

560415

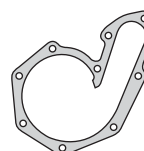

560114



560119



560131



550628



G 31.5 x 3.2



A 18 x 24 x 1.5 A



A 16 x 22 x 1.5 A



G 65 x 73 x 5



G 65 x 68 x 3.6



A 22 x 28 x 2 A



A 10 x 15 x 1.5 A



A 12 x 17 x 1 C

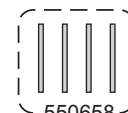

550658



R560111V



R550612P



R560113V



R560114P



R560110V

Nº OE	Descripción/Description	Mat.	1	2	Ref.
	Jgo. de juntas para motor				560400-R
	Jgo. de juntas superior				560495
7700859273	Jta. tapa cilindros Ø 83.5 ± 1.40 N.R.	NFT	1	1	560407
	Jgo. tornillos tapa cilindros (HAE14038)				B560600
	Jgo. tornillos tapa cilindros (HAE14038)				B560600-1
7700743903	Conj. junta tapa válvulas (4)	N	1	1	560110
7700859751	Junta para cárter	NFT	1	1	560111
7700854539	Múltiple admisión y escape	FCH	1	1	560415
07700851213	Tapa bomba de agua	CB	1	1	560114
7700852434	Árbol de levas	NB	1	1	560119
7700622283	Bomba nafta	NB		2	550628
	Arandela tapa bujía B 18 x 24 x 2.3 CN	CN			450029
770073667	O'ring G 31.5 x 3.2	GS		1	560129
	Arandela tapa bujía B 16 x 22 x 2.4 CN	CN			450229
	Arandela tapa válvulas A 7 x 17 x 1.5 F	NB	3	3	550430
7700718380	Anillo termostato	GS	1	1	560131
	Guarnición sintético G 65 x 68 x 3.6	GS		1	560132
	Guarnición sintético G 65 x 73 x 5	GS		1	560133
	Arandela especial B 22 x 28 x 3 CN	CN			560134
	Arandela especial B 10 x 15 x 2.4 CN	CN			560135
	Arandela especial A 14 x 20 x 2 C	CN		2	560136
	Arandela especial A 12 x 17 x 1 C	CU		1	560137
	Jgo. cierre bancada (4)	GS		1	550658
	Arandela A 10 x 15 x 1.5 A	AL		1	
	Arandela A 16 x 22 x 1.5 A	AL		1	
	Arandela A 18 x 24 x 1.5 A	AL		2	
	Arandela A 22 x 28 x 2 A	AL		4	
	Kit de retenes completo				R560400
	Jgo. retén válvulas (8)	V		1	R560110V
	Retén bancada 85 x 105 x 8	V		1	R560111V
	Retén distribución 50 x 68 x 10	P		1	R550612P
	Retén árbol levas 25 x 42 x 7	V		1	R560113V
	Retén auxiliar 22 x 45 x 7	P		1	R560114P

RENAULT



Motor/Engine **C3L Inyección** **Cm³** 1597 **HP** 74 **Ø** 76

Renault: R19 - Clio - Express 1996/98



Nº OE	Descripción/Description	Mat.	Ref.
7702217284	Jgo. de juntas para motor		560500-R
	Jgo. de juntas superior		560595
7702220799	Jta. tapa cilindros Ø 78 \pm 1.40	NFT 1 1	550905
	Jta. tapa cilindros Ø 78 \pm 2.40	NFT	550906
7702220799	Jta. tapa cilindros Ø 78 \pm 1.20 N.R.	NFT	550907
	Jgo. tornillos tapa cilindros (HAS17038)		B550400
7701036311	Conj. junta tapa válvulas (4)	P 1 1	560510
77012206018	Jgo. junta para cárter (4)	CG 1	550911
7702057213	Tapa distribución	CB 1	550412
770208065	Cuerpo y tapa bomba de agua	NB 1 1	550714
7702220795	Múltiple admisión y escape	FCH 1	550815
	Múltiple admisión y escape	NFT 1	550816
7700854668	Entre múltiple tubo primario	FCH 1 1	560517
7702080617	Bomba de agua a tapa cilindros	NB 1 1	550719
7702220616	Caja mariposa aislante	NB 2	560529
	Arandela bulbo temp. A 22 x 32 x 1.5	NB 1	550929
7702057732	Arandela tapa válvula A 7 x 17 x 1.5 F	NB 3 3	550430
	Arandela tapón cárter A 16 x 22 x 1C	CU 1	550930
	Junta placa bomba de aceite	NB 1 1	550331
7700854391	Sobre múltiple	NFT 1 1	560531
7700855273	Entre brida y múltiple	NB 1 1	560532
7700272725	Entre múltiple	NFT 1	560533
	Base bomba aceite	NB 1	550935
	Llenado de aceite	CG 1 1	450041
7701348178	Jgo. suplemento camisa cilindros (4)	GS 1	550671
	Kit de retenes completo		R550700
	Jgo. retén válvulas (8)	V 1	R550910V
	Jgo. retén válvulas (8)	T	R550910T
	Retén bancada 80 x 100 x 13	P 1	R550811P
	Retén distribución 35 x 50 x 9	P 1	R550412P
	Retén árbol levas 30 x 42 x 8	P 1	R550413P

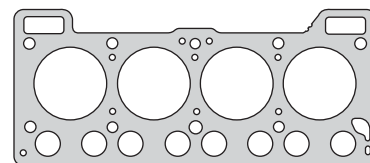

550905

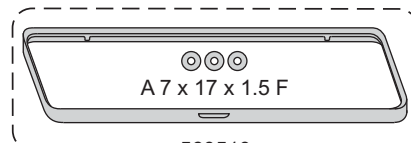

560510

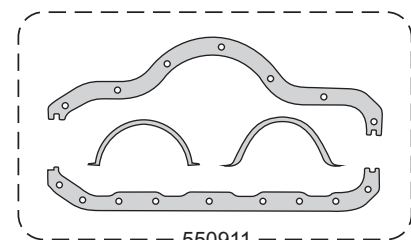

550911



550815

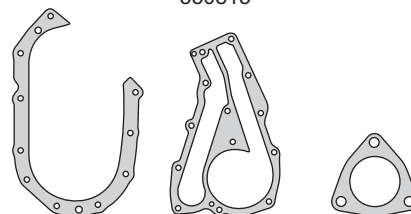

550412

550714

560517

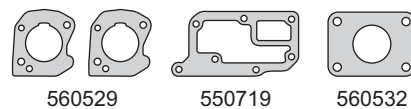

560529

550719

560532



550331

560531

560533

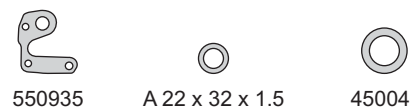

550935

A 22 x 32 x 1.5

450041

A 16 x 22 x 1C

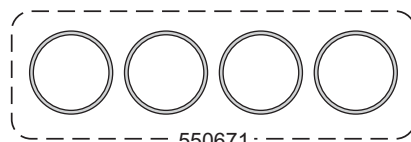

550671

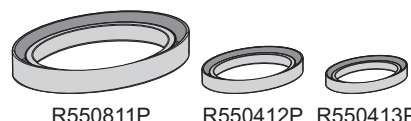

R550811P

R550412P

R550413P

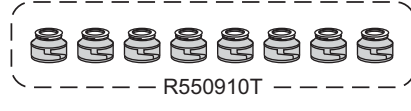

R550910T



R550910V

RENAULT / KIA

RENAULT



Motor/Engine	Cm³	HP	Ø
F8Q	1870	65	80
DIESEL			

Renault: R9 - Express - Clio - Kangoo - Trafic
Scenic - Megane



Nº OE	Descripción/Description	Mat.	1	2	Ref.
	Jgo. de juntas para motor				560601-R
	Jgo. de juntas superior		●	●	560695-1M
	Jgo. de juntas superior				560695-2M
	Jgo. de juntas superior				560695-3M
7701039398	Jta. tapa cilindros Ø 81 \pm 1.60	NFT			560607-2M
7700867870	Jta. tapa cilindros Ø 81 \pm 1.70	NFT	1		560607-1M
7701039399	Jta. tapa cilindros Ø 81 \pm 1.80	NFT			560607-3M
	Jgo. tornillos tapa cilindros (HAE14038)				B560600
	Jgo. tornillos tapa cilindros (HAE14038)				B560600-1
7700743903	Conj. junta tapa válvulas (4)	N	1	1	560110
7700859751	Junta cárter para cárter de chapa	NFT		1	560111
7700851213	Tapa bomba de agua	CB		1	560114
8200105746	Junta frente motor porta reten distribución	NB		1	560612
7700854867	Múltiple admisión y escape	NFT	1	1	560115
7700852434	Inferior árbol de levas	NB	1	1	560119
7701040923	Guarnición termostato	N		1	570319
770062283	Bomba alimentación	NH			550628
7703062014	Arandela tapa bujía B 18 x 24 x 2.3 CN	CN			450029
7700736647	O'ring G 31.5 x 3.2	GS		1	560129
7703062050	Arandela tapa bujía B 16 x 22 x 2.4 CN	CN			450229
7703061078	Arandela tapa válvulas A 7 x 17 x 1.5 F	NB	3	3	550430
7700718380	Anillo termostato	GS	1	1	560131
	Guarnición sintético G 65 x 68 x 3.6	GS		1	560132
	Guarnición sintético G 65 x 73 x 5	GS		1	560133
	Arandela especial B 22 x 28 x 3 CN	CN			560134
7703062013	Arandela especial B 10 x 15 x 2.4 CN	CN			560135
	Arandela para llamas	AC	4	4	560036
	Arandela A 14.5 x 21 x 2 C	CU	4	4	560136
	Arandela A 12 x 17 x 1 C	CU			560137
7700859220	Bomba vacío	NB	1	1	560638
7700851849	Bomba vacío	NB	1	1	560639
7701030255	Jgo. cierre bancada (4)	GS		1	550658
7700724836	O'ring bomba vacío G 74 x 3	GS		1	
	Arandela A 10 x 15 x 1.5 A	AL		1	
	Arandela A 16 x 22 x 1.5 A	AL		1	
	Arandela A 18 x 24 x 1.5 A	AL		2	
	Arandela A 22 x 28 x 2 A	AL		1	
	Kit de retenes completo				R560600
	Jgo. retén válvulas (8)	V		1	R560110V
	Retén bancada 85 x 105 x 8	V		1	R560111V
	Retén distribución 50 x 68 x 10	V		1	R550612V
	Retén árbol levas 25 x 42 x 7	V		1	R560113V
	Retén auxiliar 22 x 45 x 7	V			R560114V

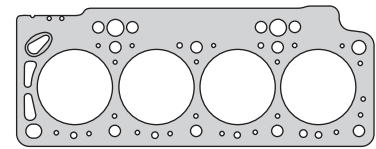

560607

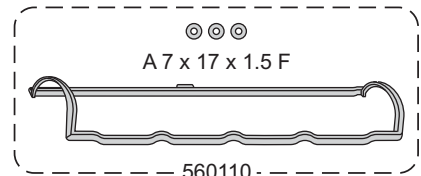

A7 x 17 x 1.5 F

560110

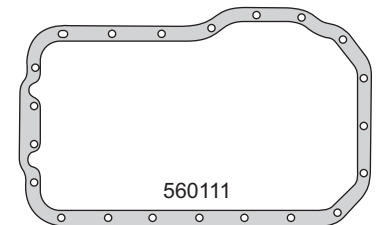

560111

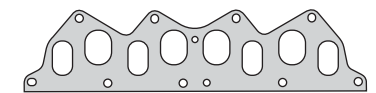

560115

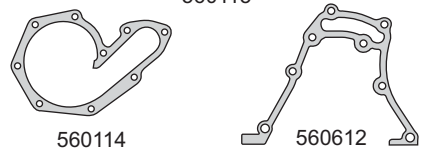

560114

560612



560119

570319

550628

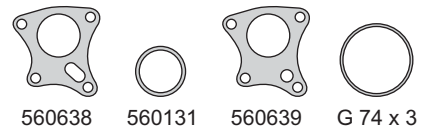

560638

560131

560639

G 74 x 3



A 14.5 x 21 x 2 C

A 12 x 17 x 1 C



A 22 x 28 x 2 A

G 31.5 x 3.2

A 10 x 15 x 1.5 A

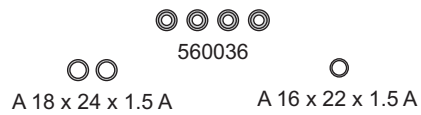

A 18 x 24 x 1.5 A

560036

A 16 x 22 x 1.5 A

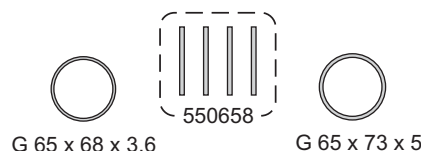

G 65 x 68 x 3.6

550658

G 65 x 73 x 5



R560111V



R550612V

R560113V

R560114V



R560110V

RENAULT



Motor/Engine	Cm³	HP	Ø
F8Q con cárter de aluminio	1870	65	80

Renault: R19 - Express - Clio - Kangoo
Trafic - Scenic - Megane

DIESEL



Nº OE	Descripción/Description	Mat.	Ref.
	Jgo. de juntas para motor		560701-R
	Jgo. de juntas superior		560695-1M
	Jgo. de juntas superior		560695-2M
	Jgo. de juntas superior		560695-3M
7701039398	Junta tapa cilindros Ø 81 ± 1.70	NFT 1	560607-1M
7700867870	Junta tapa cilindros Ø 81 ± 1.60	NFT	560607-2M
7701039399	Junta tapa cilindros Ø 81 ± 1.80	NFT	560607-3M
	Jgo. tornillos tapa cilindros (HAE14038)		B560600
	Jgo. tornillos tapa cilindros (HAE14038)		B560600-1
7700743903	Conj. junta tapa válvulas (4)	N 1 1	560110
7700108057	Junta cárter para cárter de aluminio	N 1	560611
8200105746	Junta frente motor porta retén distribución	NB 1	560612
7700851213	Tapa bomba de agua	CB 1	560114
7700854867	Múltiple admisión y escape	FCH 1 1	560115
7700852434	Inferior árbol de levas	NB 1 1	560119
7701040923	Guarnición termostato	N 1	570319
770062283	Bomba alimentación	NB	550628
	Arandela tapa bujía B 18 x 24 x 2.3 CN	CN	450029
7700736647	O'ring G 31.5 x 3.2	GS 1	560129
	Arandela tapa bujía B 16 x 22 x 2.4 CN	CN	450229
7703061078	Arandela tapa válvulas A 7 x 17 x 1.5 F	NB 3 3	550430
7700718380	Anillo termostato	GS 1 1	560131
	Guarnición sintético G 65 x 68 x 3.6	GS 1	560132
	Guarnición sintético G 65 x 73 x 5	GS 1	560133
	Arandela especial B 22 x 28 x 3 CN	CN	560134
	Arandela especial B 10 x 15 x 2.4 CN	CN	560135
	Arandela para llamas	AC 4 4	560036
	Arandela A 14.5 x 21 x 2 C	CU 4 4	560136
7700859220	Arandela A 12 x 17 x 1 C	CU	560137
7700851849	Bomba vacío	NB 1 1	560638
7700724836	Bomba vacío	NB 1 1	560639
	Bomba depresora	GS 1	570345
	Guarnición bomba depresora	GS 1	570346
	Jgo. cierre bancada (4)	GS 1	550658
7701030255	O'ring bomba vacío G 74 x 3	GS 1	
	Arandela A 10 x 15 x 1.5 A	AL 1	
	Arandela A 16 x 22 x 1.5 A	AL 1	
	Arandela A 18 x 24 x 1.5 A	AL 2	
	Arandela A 22 x 28 x 2 A	AL 1	
	Kit de retenes completo		R560700
	Jgo. retén válvulas (8)	V 1	R560110V
	Retén bancada 85 x 105 x 8	V 1	R560111V
	Retén distribución 42 x 54 x 6	V 1	R570412V
	Retén árbol levas 25 x 42 x 7	V 1	R560113V
	Retén auxiliar 22 x 45 x 7	P	R560114P

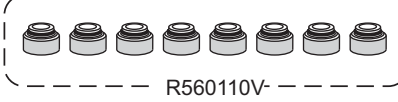
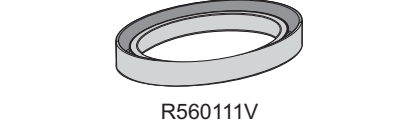
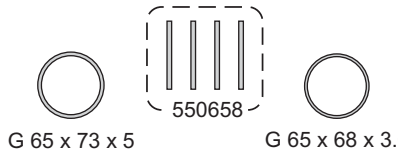
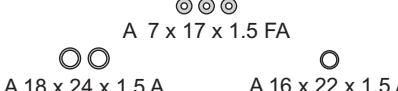
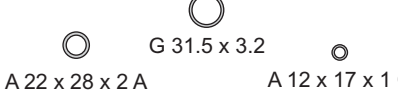
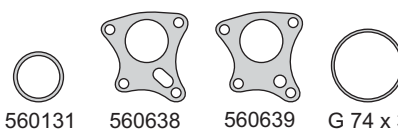
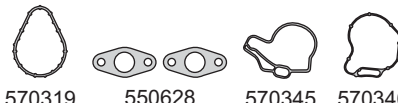
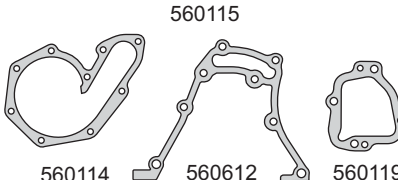
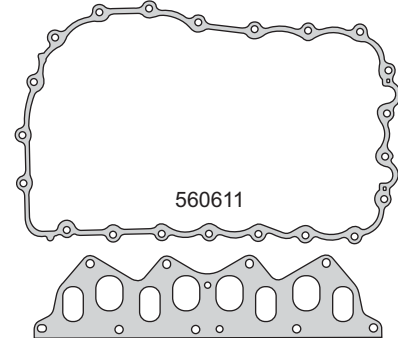
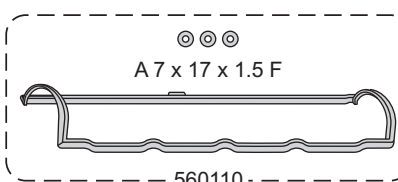
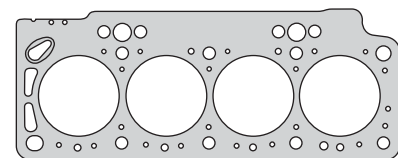

RENAULT / KA

RENAULT



Motor/Engine	Cm³	HP	Ø
E5F/E7F E6J/E7J Energy	1171 1390	55/60 77/80	75.8 75.8

Renault: E5F/E7F Clio - R19 1990/98
E6J/E7J Clio - R19 - Express 1990/95
Kangoo 2001/... - Megane 1995/97



RENAULT / IKA

Nº OE	Descripción/Description	Mat.	Ref.
	Jgo. de juntas para motor		560800-R
	Jgo. de juntas superior	●	560895
	Junta tapa cilindros Ø 77 \pm 1.40 N.R.º	NFT 1 1	560807
	Jgo. tornillos tapa cilindros (HAE12038)		B560800
7700854640	Junta tapa válvulas	CB 1 1	560810
7700739392	Junta para cárter	N 1 1	560811
	Tapa bomba de agua	CB 1 1	560814
	Múltiple escape	NFT 1 1	560816
7700749824	Múltiple admisión	NFT 1 1	560817
	Tapa bomba nafta	CB 1 1	560828
	Bomba nafta	CB 2 2	570029
7703062062	Arandela tapón cárter A 16 x 22 x 1 C	CU	550930
	Junta admisión	NB 1 1	560832
7700575468	Jgo. suplemento camisas cilindros (4)	GS 1 1	550671
	O'ring G 36.17 x 2.62	GS	1
	Arandela A 16 x 21 x 1.5 C	AL	1
	Kit de retenes completo		R560800
	Jgo. retén válvulas (8)	V 1 1	R560810V
	Retén bancada 80 x 100 x 8	V 1 1	R570011V
	Retén distribución 35 x 47 x 7	P 1 1	R550613P
	Retén árbol levas 30 x 42 x 7	P 1 1	R260113P

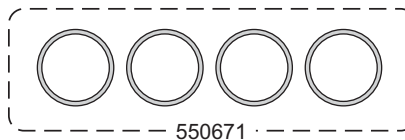
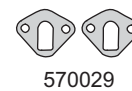
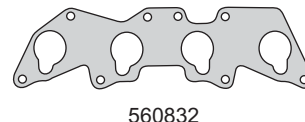
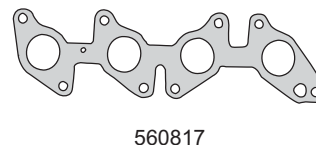
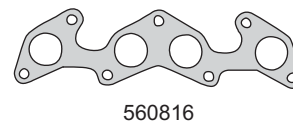
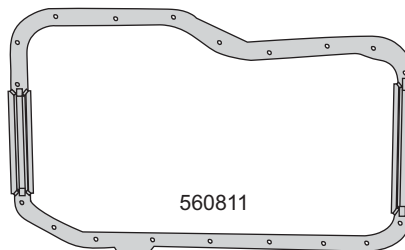
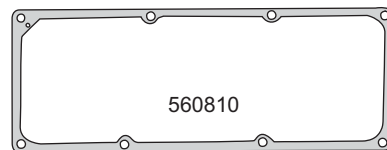
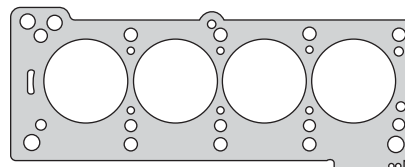

RENAULT



Motor/Engine **C3G** **1239** **55** **74**

Renault: Twingo - Clío - Express 1992/...



Nº OE	Descripción/Description	Mat.	Ref.
	Jgo. de juntas para motor		570000-R
	Jgo. de juntas superior		570095
7702080611	Junta tapa cilindros Ø 77 \pm 1.40	NFT 1 1	550705
	Junta tapa cilindros Ø 77 \pm 1.20 N.R. (HAS17038)	NFT	550707
	Jgo. tornillos tapa cilindros (HAS17038)		B550400
7701036311	Conj. junta tapa válvulas (4)	P 1 1	560510
7702070195	Jgo. junta para cárter (4)	CG 1	550711
7702057213	Tapa distribución	CG 1	550412
770208065	Tapa bomba de agua	NB 1 1	550714
770220795	Múltiple admisión y escape	NFT 1	550815
	Múltiple admisión y escape	NFT 1	550816
7702080617	Bomba de agua a tapa de cilindros	NB 1 1	550719
	Bomba nafta block	NB 1	570028
	Base bomba nafta	CB 2	570029
	Arandela B 16 x 22 x 2.4 CN	CN	450229
	Arandela termostato A 22 x 33 x 1.5	NB	550929
	Brida	NB 1	570030
7702057732	Arandela tapa válvulas A 7 x 17 x 1.5 FA	NB 3 3	550430
7704000287	Tapa cámara de agua	NB 1 1	550331
0607155200	Bomba aceite a block	NB 1	550435
6071557	Base distribuidor	NB 1	550338
7701348178	Jgo. suplemento camisa cilindros (4)	GS 1	550671
	Jgo. suplemento camisa cilindros (4)	CU 1	550470-0.10
	Arandela A 8 x 14 x 1 C	CU 1	
	Arandela A 14 x 20 x 1.5 C	CU 1	
	Arandela A 16 x 22 x 1.5 A	AL 1	
	Kit de retenes completo		R570000
	Jgo. retén válvulas (8)	V 1	R550910V
	Retén distribución 35 x 50 x 9	P 1	R550412P
	Retén bancada 80 x 100 x 8	V 1	R570011V

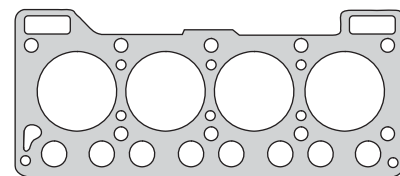

550705

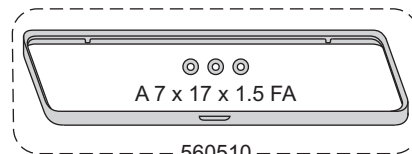

A 7 x 17 x 1.5 FA

560510

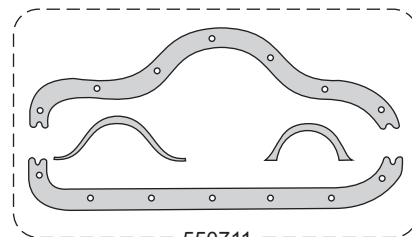

550711

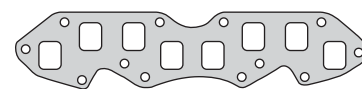

550815/550816

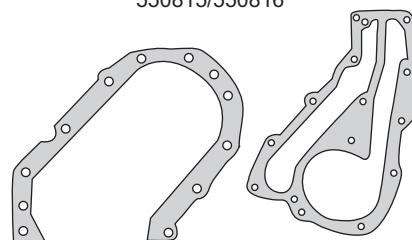

550412

550714

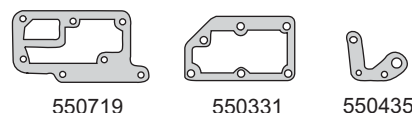

550719

550331

550435

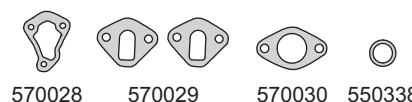

570028

570029

570030

550338

A 8 x 14 x 1 C

A 14 x 20 x 1.5 C

A 16 x 22 x 1.5 A



550470-0.10

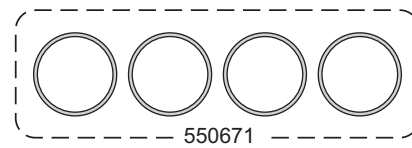

550671



R570011V



R550412P



R550910V

RENAULT / KKA

RENAULT



Motor/Engine	Cm³	HP	Ø
F7R 700/710/714	1998	150	82.7
F7P 700/704	1764	133/140	82
720/722 16V			

Renault: Clio Williams - Spider Sport 1993/...
Megane Coupe 1995/99
Clio 1991/99 - R19 1989/96



RENAULT / IKA

Nº OE	Descripción/Description	Mat.			Ref.
	Jgo. de juntas para motor				570100-R
	Jgo. de juntas superior		●	●	570195
7700850292	Junta tapa cilindros Ø 84 \pm 1.30 N.R.	NFT	1	1	570107
	Jgo. de tornillos JTC (HAT55055/HAT55100)				B570100
7701040740	Junta tapa válvulas superior	NB	1	1	570110
7701040741	Junta tapa válvulas inferior	NB	1	1	570136
7700859751	Junta para cárter	NFT		1	560111
7700851213	Bomba de agua	CB		1	560114
7700865249	Múltiple escape	NFT	1	1	570115
7700869886	Múltiple admisión	NB	1	1	570117
	Múltiple admisión	NFT			570117-1
7700852434	Inferior árbol de levas	NB	1	1	560119
7700718380	Guarnición termostato	GS		1	560131
	Arandela tapón cárter A 16 x 22 x 2 C	CU		1	
	Kit de retenes completo				R570100
7700736465	Jgo. retén válvulas (16)	V		1	R570110V
7703087190	Retén bancada 85 x 105 x 8	V		1	R560111V
7700719274	Retén distribución 50 x 68 x 10	P		1	R550612P
7703087192	Retén árbol de levas 25 x 42 x 7	V		2	R560113V

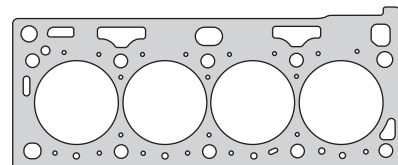

570107

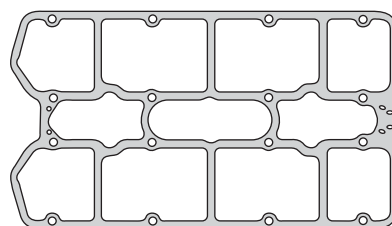

570110

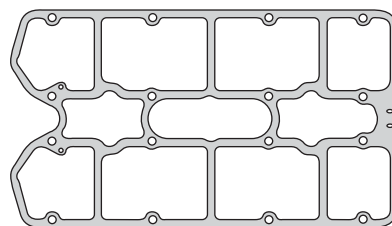

570136

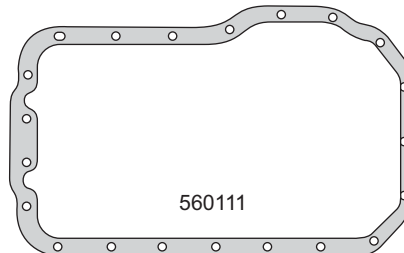

560111

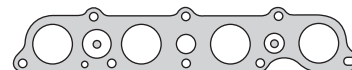

570115



570117

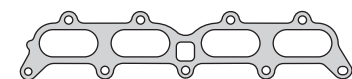

570117-1

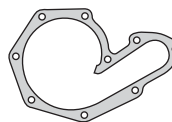

560114



560119



560131



A 16 x 22 x 2 C



R560111V



R550612P



R560113V



R570110V

RENAULT



Motor/Engine	Cm³	HP	Ø
K7M-744/745	1598	75/90	79.5

Renault: Megane Scenic RN - Clío 1998/...
Clío II 1998/05
Sandero 2007/... - Symbol



Nº OE	Descripción/Description	Mat.	Ref.
	Jgo. de juntas para motor		570200-R
	Jgo. de juntas superior		570295
	Junta tapa cilindros Ø 80 \pm 1.30 N.R.®	NFT 1 1	570207
	Jgo. tornillos tapa cilindros (HAE12038)		B570200
7700854640	Junta tapa válvulas	CB	560810
	Junta tapa válvulas	SLS 1 1	560831
7700273486	Junta para cárter	N	570211
	Bomba de agua	CB	560814
7700867360	Múltiple escape con deflector	AC	570215
7700867360	Múltiple escape	NFT 1	560816
7700865764	Múltiple admisión	NB 1 1	570217
7701471932	Jgo. múltiple admisión (4) - Clío II 1998/05	GS 1 1	571017
	Salida de escape	AC/AS	570218
7700851497	Tapa bomba nafta	CB 1 1	560828
7700272895	Tapa trasera árbol levas	NFT 1 1	570229
7700740028	O'ring llenado aceite G 40 x 5	GS 1 1	570241
7703062062	Arandela tapón cárter A 16 x 21 x 2 C	CU 1 1	
	Kit de retenes completo		R560800
7700736465	Jgo. retén válvulas (8)	V 1	R560810V
7700859692	Retén bancada 80 x 100 x 8	V 1	R570011V
7700854842	Retén distribución 35 x 47 x 7	P 1	R550613P
7700749395	Retén árbol levas 30 x 42 x 7	P 1	R260113P

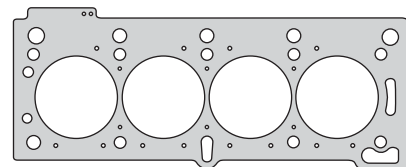

570207

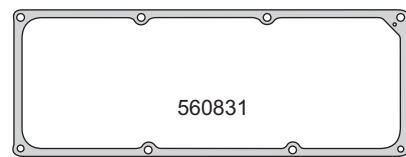

560831

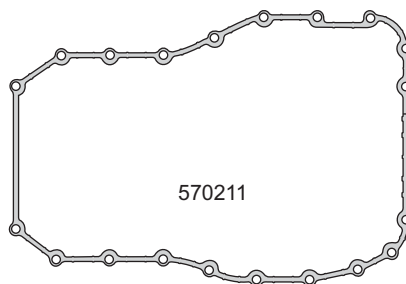

570211

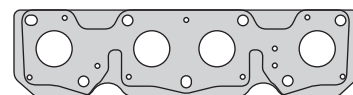

560814



560816



570217

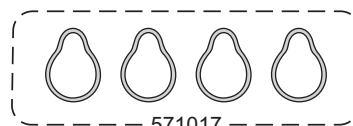

571017

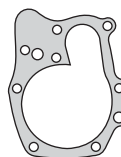

560814



560828



570218



570229



A 16 x 21 x 2 C



570241



R570011V



R550613P



R260113P



R560810V

RENAULT



Motor/Engine	Cm³	HP	Ø
F9Q Turbo Iny. Directa (SOHC) 8V	1870	80/100	80
DIESEL			

Renault: Megane DTI - RN - RT
Laguna 716/730/734/750
Scenic 736 - Space 722 1999/...
Kangoo 2000/...
Megane Coupe DTI 731 2000/...

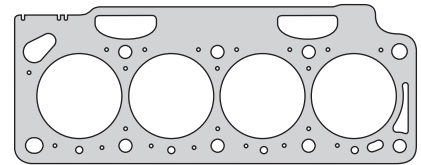

570307

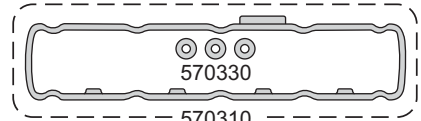

570330

570310

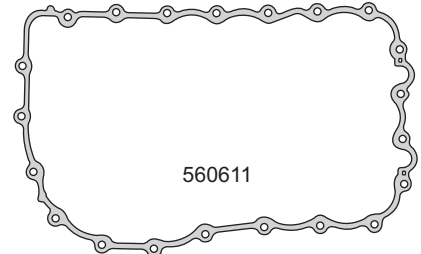

560611

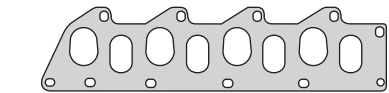

570315



560114

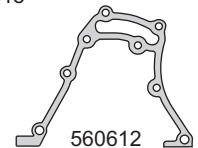

560612



560119



570319



550628



560131



570338



560036



570343



570344



570345



570346



550658



G 74 x 3



G 65 x 73 x 5



G 28.17 x 3.53



G 65 x 68 x 3.6



A 16 x 22 x 1.5 C



A 22 x 28 x 2 A



A 14.5 x 21 x 2 C



A 18 x 24 x 1.5 A



A 10 x 15 x 1.5 A



R560111V



R570412V



R560113V



R550615P



R560810V

Nº OE	Descripción/Description	Mat.	1	2	Ref.
	Jgo. de juntas para motor				570301-R
	Jgo. de juntas superior		●		570395-1M
	Jgo. de juntas superior				570395-2M
	Jgo. de juntas superior				570395-3M
7700667325	Junta tapa cilindros Ø 81 ± 1.50	NFT	1		570307-1M
7700105392	Junta tapa cilindros Ø 81 ± 1.40	NFT			570307-2M
7700105393	Junta tapa cilindros Ø 81 ± 1.60	NFT			570307-3M
	Jgo. tornillos tapa cilindros (HAE14038)				B570300
7700874515	Conj. junta tapa válvulas (4)	N	1	1	570310
7700108057	Junta cárter para cárter aluminio	N		1	560611
8200105746	Junta frente motor porta retén distribución	NB		1	560612
7700851213	Bomba de agua	CB		1	560114
7700874592	Múltiple admisión y escape	SLS	1	1	570315
7700852454	Inferior árbol levas	NB		1	560119
7701040923	Guarnición termostato	GS	1	1	570319
7701030255	Bomba alimentación	NB		2	550628
	Arandela B 18 x 24 x 2.3 CN	CN			450029
	Arandela tapa válvula	AC/GS	3	3	570330
	Termostato	GS	1	1	560131
	Guarnición sintético G 65 x 68 x 3.6	GS		1	560132
	Guarnición sintético G 65 x 73 x 5	GS		1	560233
	Arandela B 22 x 28 x 3 CN	CN			560134
	Arandela pico inyector	AC	4	4	560036
7700724836	Guarnición bomba vacío	NB		1	570338
7701046634	O'ring bomba vacío G 74 x 3	GS		1	560640
	Entrada a turbo	FCH			570343
	Salida a turbo	FCH			570344
7701045660	Jta. bomba depresora Magnetti/Marelli	GS		1	570345
7703061078	Jta. bomba depresora Pierburg	GS		1	570346
	Jgo. cierre bancada (4)	GS		1	550658
	Arandela A 10 x 15 x 1.5 A	AL		1	
	Arandela A 16 x 22 x 1.5 C	CU		1	
	Arandela A 14.5 x 21 x 2 C	CU		4	
	Arandela A 18 x 24 x 1.5 A	AL		1	
	Arandela A 22 x 28 x 2 A	AL		1	
	O'ring G 28.17 x 3.53	GS		1	
	Kit de retenes completo				R570300
	Jgo. retén válvulas (8)	V		1	R560810V
	Retén bancada 85 x 105 x 8	V		1	R560111V
	Retén distribución 42 x 54 x 6	V		1	R570412V
	Retén árbol levas 25 x 42 x 7	V		1	R560113V
	Retén auxiliar 30 x 40 x 7	P			R550615P

RENAULT / IKA

RENAULT



Motor/Engine **F3R 722/796/729** Cm³ **1998** HP **115** Ø **82.7**

Renault: Megane RT - Scenic
Laguna RT - RXE



Nº OE	Descripción/Description	Mat.	Ref.
	Jgo. de juntas para motor		570400-R
7700859273	Jta. tapa cilindros Ø 83.5 ± 1.40	NFT	1 560407
	Jgo. tornillos tapa cilindros (HAE14038)		B560600
7700719666	Conj. junta tapa válvulas (4)	N	1 560110
7700108057	Junta cárter para cárter aluminio	N	1 560611
7700851213	Tapa bomba de agua	CB	1 560114
7700854539	Múltiple admisión y escape	NFT	1 560415
	Salida de escape	NFT	1 570418
7700836096	Acople caño escape - Megane/Scenic	AC	1 581218
7700423572	Acople caño escape - Laguna	AC	570418-2
7700852434	Árbol de levas	NB	1 560119
7701040923	Guarnición termostato	GS	1 570319
7700622283	Bomba nafta	NB	2 550628
	Arandela B 18 x 24 x 2.3 CN	CN	450029
7700736647	O'ring G 31.5 x 3.2	GS	1 560129
	Arandela B 16 x 22 x 2.4 CN	CN	450229
7703061078	Arandela tapa válvulas A 7 x 17 x 1.5 F	NB	3 550430
7700718380	Anillo termostato	GS	1 560131
700736647	Guarnición sintética radiador aceite	GS	560132
7700709470	Guarnición sintética G 65 x 68 x 3.6	GS	1 560133
	Arandela especial B 22 x 28 x 3 C	CN	560134
	Arandela A 14.5 x 21 x 2 C	CU	2 560136
7701030255	Jgo. cierre bancada (4)	GS	1 550658
	Arandela A 12 x 16 x 1 C	CU	2
	Arandela A 16 x 22 x 1.5 A	AL	2
	Arandela A 18 x 24 x 1.5 A	AL	2
	Arandela A 22 x 28 x 2 A	AL	1
	O'ring G 65 x 73 x 5	GS	1
	Kit de retenes completo		R570400
	Jgo. retén válvulas (8)	V	1 R560110V
	Retén bancada 85 x 105 x 8	V	1 R560111V
	Retén distribución 42 x 54 x 6	V	1 R570412V
	Retén árbol levas delantero 25 x 42 x 7	V	1 R560113V
	Retén árbol levas trasero 22 x 45 x 7	V	1 R560114V
	Retén auxiliar 30 x 40 x 7	V	1 R550615V

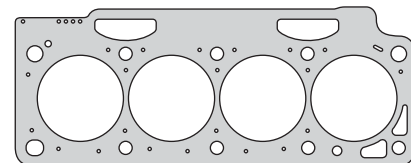

560407

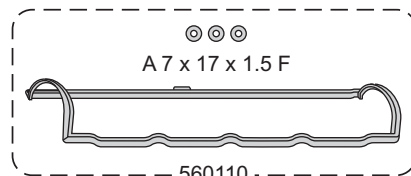

A 7 x 17 x 1.5 F

560110

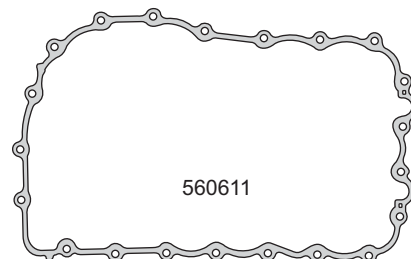

560611

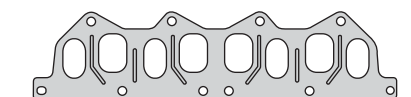

560415

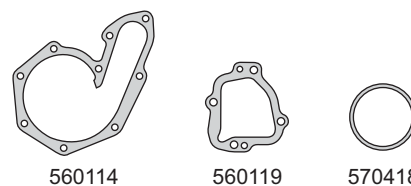

560114

560119

570418

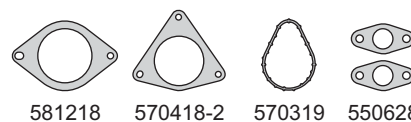

581218

570418-2

570319

550628



560131

G 31.5 x 3.2

560132



A 18 x 24 x 1.5 A

A 16 x 22 x 1.5 A

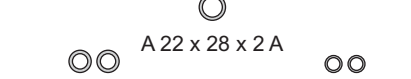

A 22 x 28 x 2 A

A 14.5 x 21 x 2 C

A 12 x 16 x 1 C

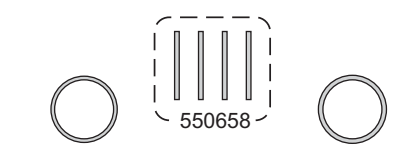

550658

G 65 x 68 x 3.6

G 65 x 73 x 5

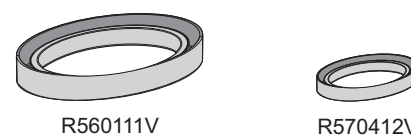

R560111V

R570412V



R560113V

R560114V

R550615V



R560110V

RENAULT / KA

RENAULT



Motor/Engine	Cm³	HP	Ø
D7F/D7D 700 701/710/730/734	1149	55/60	69

Renault: Twingo 1996/... - Clío 1995/...
Kangoo 1997/...
D7D - Twingo 2001/...



RENAULT / IKA

Nº OE	Descripción/Description	Mat.	Ref.
	Jgo. de juntas para motor		570500-R
	Jgo. de juntas superior	●	570595
8200034315	Junta tapa cilindros Ø 70 \pm 1.40 N.R.º	NFT 1 1	570507
	Jgo. tornillos tapa cilindros (HAE12038)		B570500
7701471213	Junta tapa válvulas - Hasta 09/2000	SLS 1 1	570510
7701049734	Junta tapa válvulas - Desde 09/2000	N 1 1	570536
7700866465	Junta para cárter	NB 1 1	570511
7700866689	Múltiple escape	AC 1 1	570515
7700204945	Jgo. múltiple admisión (2)	N 1 1	570517
	Anillo G 45 x 49 x 5	GS 1 1	
	Kit de retenes completo		R570500
7700862483	Jgo. retén válvulas (8)	V 1	R570510V
7700873534	Retén bancada 70 x 86 x 8	V 1	R570511V
7700874223	Retén distribución 32 x 44 x 6	V 1	R570512V
7700749395	Retén árbol de levas 30 x 42 x 7	P 1	R260113P

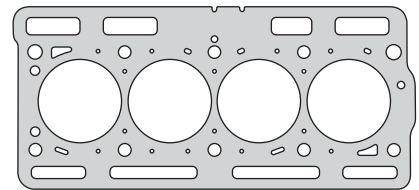

570507

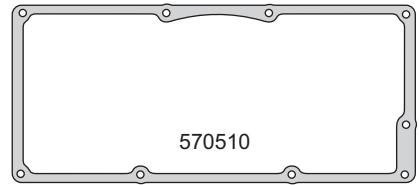

570510

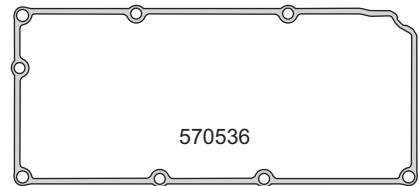

570536

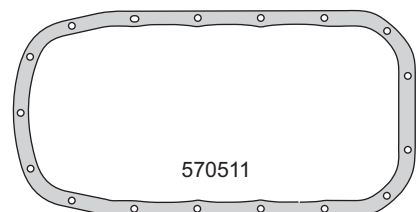

570511



570515

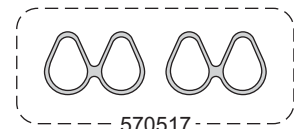

570517



G 45 x 49 x 5



R570511V



R570512V



R260113P



R570510V

RENAULT



Motor/Engine	Cm³	HP	Ø
B4184S	1731	115	83
N7Q	1948	138/140	83
B4204S/T	1948	140	83
B4204T	1948	160	83

Renault: Laguna N7Q/700/704 1994/99
 Safrane N7Q/710/711 1996/99
 Space N7Q 1996/...
Volvo: S40/V40 B4184S 1995/...
 S40/V40 B4204S/4204T 1996/...

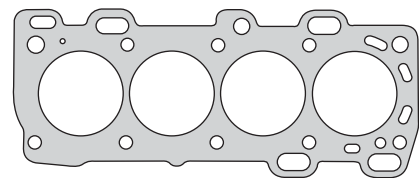

570607

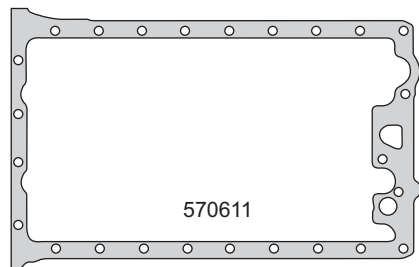

570611



570615



570617

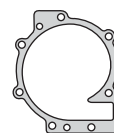

570614



570619

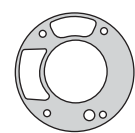

570627



550628



G 50.47 X 2.62



570629

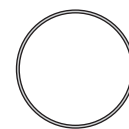

G 124 x 3



G 65 x 3 S



G 30 x 2.62



G50.52 x 1.78



A 19 x 24 x 1.5 A



G 32 x 3



G 20 x 2.5



R570611V



R570612V



R570613V



R570614P

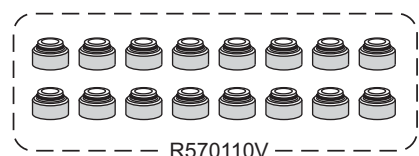

R570110V

Nº OE	Descripción/Description	Mat.	Ref.
	Jgo. de juntas para motor		570600-R
	Jgo. de juntas superior		570695
	Junta tapa cilindros Ø 85 ± 1.70 N.R.	NFT 1 1	570607
	Jgo. tornillos tapa cilindros (HAS14038)		B570600
	Junta para cárter	NB 1	570611
7431397532	Tapa bomba de agua	NB 1	570614
7439146313	Jgo. múltiple escape (4)	NFT 1 1	570615
7431366788	Múltiple admisión	NFT 1 1	570617
	Base termostato	NB 1 1	570619
7439135830	Tapa bomba aceite	NB 1 1	570627
7700622283	Retorno de agua	NB 1 1	550628
	Guarnición goma G 22 x 27 x 4 S	GS	570629
	Arandela tapón cárter A 19 x 24 x 1.5 A	AL	1
	Cierre protección bujias o ring G 50.52 x 1.78	GS 4 4	
	O'ring G 32 x 3	GS	1
	O'ring G 30 x 2.62	GS	1
	O'ring G 20 x 2.5	GS	1
	O'ring pre-filtro cárter G 50.47 x 2.62	GS	
	O'ring G 65 x 3	GS	
7430925096	O'ring bomba aceite G 124 x 3	GS	
	Kit de retenes completo		R570600
7700736465	Jgo. retén válvulas (16)	V 1	R570110V
7436842092	Retén bancada 98 x 110 x 7	V 1	R570611V
7436842273	Retén distribución 35 x 47 x 5.5	V 1	R570612V
7436842272	Retén árbol de levas 45 x 57 x 6.5	P 2	R570613P
7439443310	Retén árbol de levas trasero 30 x 47 x 6	P 2	R570614P

RENAULT / KIA

RENAULT



Motor/Engine	Cm³	HP	Ø
K4J 16V	1390	95/98	79.5
K4M 16V	1598	110	79.5

Renault: K4J - Clio II 2001/... - Scenic 1999/...
 Megane II 2003/...
 K4M - Clio - Scenic - Megane - Symbol
 Laguna 1998/00 - Logan 2007/...
 Fluence - Duster Serie 838

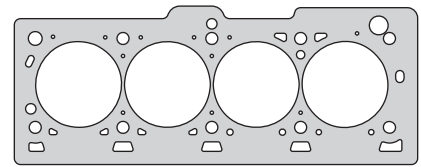

570907

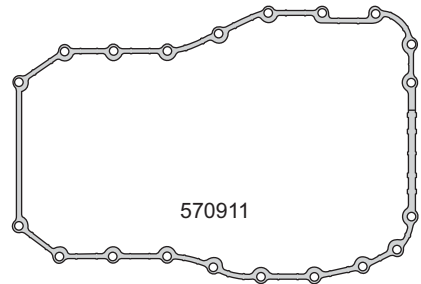

570911

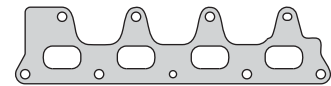

570915



570917

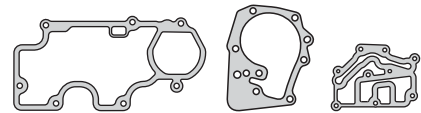

570910

570914

570919



570930

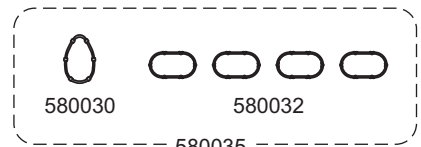

580030

580032

580035



570938



A 16 x 24 x 1 C



570939



R570011V



R550613V



R570913V

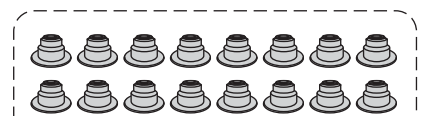

R570910V

Nº OE	Descripción/Description	Mat.	Ref.
	Jgo. de juntas para motor		570900-R
	Jgo. de juntas superior	●	570995
	Jgo. de juntas superior (MLS)		570995 MLS
	Junta tapa cilindros Ø 80.5 ± 1.40	NFT 1 1	570907
	Junta tapa cilindros Ø 80.5 ± 1.40	MLS	570908
	Jgo. tornillos tapa cilindros (HAE12038)		B570900
	Junta ventilación tapa válvula	NB 1 1	570910
	Junta para cárter	N 1 1	570911
8200659199	Bomba de agua	SLS 1 1	570914
	Múltiple escape	AC 1 1	570915
	Múltiple admisión	SLS 1 1	570917
	Base termostato	SLS 1 1	570919
	Base termostato	GS 1 1	570930
7700109420	Guarnición goma admisión	N 1 1	580030
7700109421	Múltiple entre colector	N 4 4	580032
	Jgo. entre múltiple admisión (5)	N 1 1	580035
	Tapón árbol de levas	GS 1 1	570938
	Tapón árbol de levas	GS 1 1	570939
	Suplemento junta tapa cilindros (0.50)	AC	57985-0.50
	Arandela A 16 x 24 x 1 C	CU 1	
	Kit de retenes completo		R570900
	Jgo. retén válvulas (16)	V 1	R570910V
	Retén bancada 80 x 100 x 8	V 1	R570011V
	Retén distribución 35 x 47 x 7	V 1	R550613V
	Retén árbol de levas 28 x 42 x 5	V 2	R570913V

RENAULT / IKA

RENAULT



Motor/Engine	Cm³	HP	Ø
K7J 710/714	1390	75	79.5
K7M 710/718	1598	90	79.5
K7M 810/814	1598	90	79.5

Renault: Sandero 2008/... - Logan 2004/...
Dacia: Sandero 2008/... - Logan 2004/...



Nº OE	Descripción/Description	Mat.	Ref.
	Jgo. de juntas para motor		● 571000-R MLS
7701475899	Jgo. de juntas superior (MLS)	●	571095 MLS
8200296969	Jta. tapa cilindros Ø 80.5 ± 0.42 N.R. (HAE12038)	MLS 1	1 571008
7700738987	Jgo. tornillos tapa cilindros		B570200
7701471719	Junta tapa válvulas	SLS 1	1 560831
7700273486	Junta para cárter	GS 1	1 570211
8200659199	Junta bomba de agua	SLS 1	1 570914
8200191371	Múltiple escape	AC 1	1 571015
7701471932	Jgo. múltiple admisión (4)	GS 1	1 571017
	Salida de escape	AC/AS 1	1 570218
8200267272	Guarnición termostato	GS 1	1 571019
	Base termostato	GS 1	1 570930
7703620621	Arandela tapón cárter A 16 x 21 x 2 C	CU 1	1
	Kit de retenes completo		R560800
8200234651	Jgo. retén válvulas (8)	V 1	1 R560810V
7700859692	Retén bancada 80 x 100 x 8	V 1	1 R570011V
7700273776	Retén distribución 35 x 47 x 7	P 1	1 R550613P
7700101348	Retén árbol de levas 30 x 42 x 7	P 1	1 R260113P

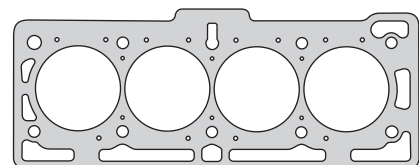

571008

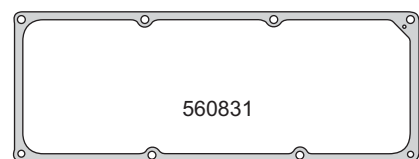

560831

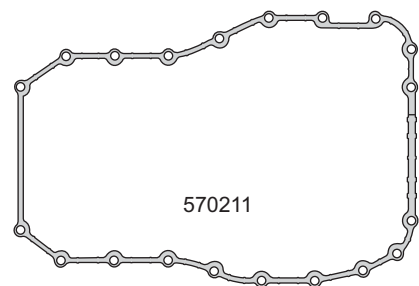

570211



571015

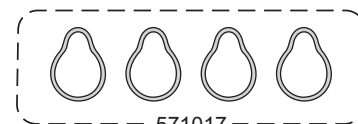

571017



570914



570218



571019



570930



A 16 x 21 x 2 C



R570011V



R260113P



R550613P



R560810V

RENAULT / KIA

RENAULT



Motor/Engine	Cm³	HP	Ø
F4P	1783	120	82.7
F4R (DOHC) 16V	1998	140/169	82.7

Renault: Laguna 1998/... - Megane - Scenic
Espace - Grand Espace - Laguna
Master - Trafic 1999/...
Laguna - Scenic - Megane - Kangoo
Clio II Sport 2001/...
Duster 2011/...

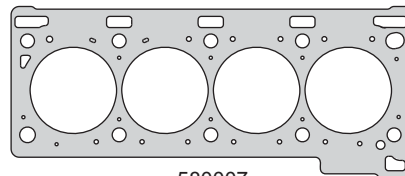

580007

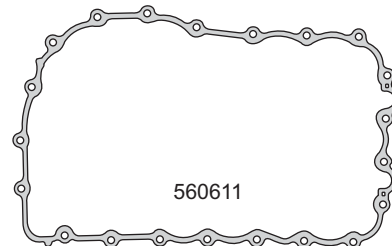

560611

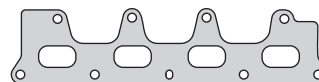

580015

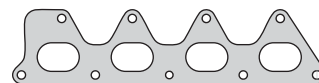

580016



580017

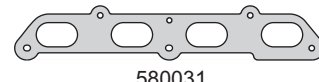

580031

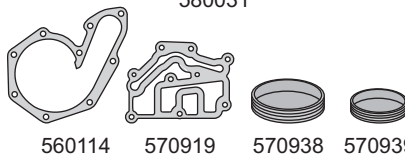

560114

570919

570938

570939

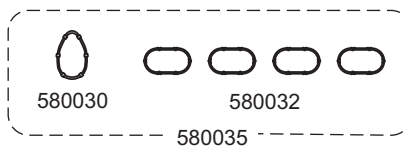

580030

580032

580035



G 28.17 x 3.53

A 16 x 24 x 1.5 A

A 10 x 15 x 1.5 A

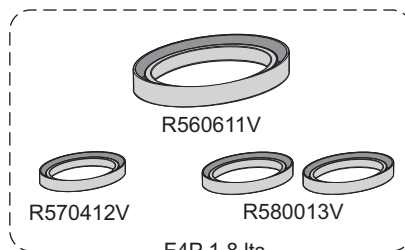

R560611V

R570412V

R580013V

F4P 1.8 lts.

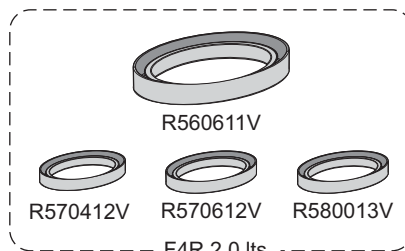

R560611V

R570412V

R570612V

R580013V

F4R 2.0 lts.

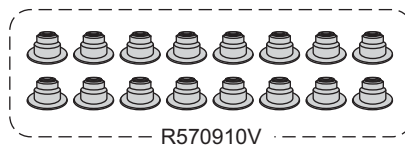

R570910V

Nº OE	Descripción/Description	Mat.	1	2	Ref.
	Jgo. de juntas para motor				580000-R
	Jgo. de juntas superior		●	●	580095
	Jgo. de juntas superior (MLS)				580095 MLS
7700108254	Junta tapa cilindros Ø 84 ± 1.20	NFT	1	1	580007
7700104129	Junta tapa cilindros Ø 84 ± 0.60	MLS			580008
	Jgo. tornillos tapa cilindros (HAE14038)				B580000
7700108057	Junta para cárter	N		1	560611
7700851213	Tapa bomba de agua	CB		1	560114
7700105843	Múltiple escape	AC	1	1	580015
7700114234	Múltiple escape Clio II - Sport	AC	1	1	580016
7700109906	Múltiple admisión	SLS	1	1	580017
7700104129	Base capa termostato	SLS	1	1	570919
7700109420	Guarnición goma admisión	N	1	1	580030
7700114203	Entre múltiple admisión Clio II - Sport	SLS	1	1	580031
7700109421	Múltiple entre colector	N	4	4	580032
	Jgo. entre múltiple admisión (5)	N	1	1	580035
	Tapón árbol de levas	GS		1	570938
	Tapón árbol de levas	GS		1	570939
	Arandela A 10 x 15 x 1.5 A	AL		1	
	Arandela con inserto A 16 x 24 x 1.5 A	AL		1	
	O´ring G 28.17 x 3.53	GS	1	1	
	Kit de retenes completo				R580000
	Jgo. retén válvulas (16)	V		1	R570910V
770308224	Retén bancada 85 x 105 x 11	V		1	R560611V
7700103245	Retén distribución 42 x 54 x 6	V		1	R570412V
7436842272	Retén distribución 35 x 47 x 5.5 - F4R	V		1	R570612V
7700106879	Ret. árbol de levas 28 x 47 x 5.5 - F4P	V		2	R580013V

RENAULT



Motor/Engine	Cm³	HP	Ø
F8Q Iny. Indirecta	1870	65	80

Renault: Clio II 630/632/662
Kangoo 630/632/662 1998/...
Rodeo Trafic 600/606 1998/...
Express 644/648 1997/...
Scenic 1999/... - Megane 1997/...



DIESEL

Nº OE	Descripción/Description	Mat.	Ref.
	Jgo. de juntas para motor		560701-R
	Jgo. de juntas superior	●	580195-1M
	Jgo. de juntas superior		580195-2M
	Jgo. de juntas superior		580195-3M
7700875717	Jta. tapa cilindros Ø 80.7 \pm 1.50	NFT	1 580107-1M
7700108167	Jta. tapa cilindros Ø 80.7 \pm 1.45	NFT	580107-2M
7700108170	Jta. tapa cilindros Ø 80.7 \pm 1.60	NFT	580107-3M
	Jgo. tornillos tapa cilindros		B570300
7700743903	Conj. junta tapa válvulas (4)	N	1 560110
7700108057	Junta cárter para cárter aluminio	N	1 560611
8200105746	Junta frente motor par retén distribución	NB	1 560612
7700851213	Tapa bomba de agua	CB	1 560114
7700854867	Múltiple admisión y escape	FCH	1 1 560115
7700852434	Inferior árbol de levas	NB	1 1 560119
	Guarnición termostato	GS	1 570319
770062283	Bomba alimentación	NB	550628
	Arandela tapa bujía B 18 x 24 x 2.3 CN	CN	450029
7700736647	O'ring G 31.5 x 3.2	GS	1 560129
7701040923	Arandela tapa bujía B 16 x 22 x 2.4 CN	CN	450229
7703061078	Arandela tapa válvulas A 7 x 17 x 1.5 FA	NB	3 3 550430
7700718380	Anillo termostato	GS	1 1 560131
	Guarnición sintético G 65 x 68 x 3.6	GS	1 560132
	Guarnición sintético G 65 x 73 x 5	GS	1 560133
	Arandelas especial B 22 x 28 x 3 CN	CN	560134
	Arandelas especial B 10 x 15 x 2.4 CN	CN	560135
	Arandela para llamas	AC	4 4 560036
	Arandela especial A 14.5 x 21 x 2 C	CU	4 4 560136
	Arandela A 12 x 17 x 1 C	CU	560137
7700859220	Bomba vacío	NB	1 1 560638
7700851849	Bomba vacío	NB	1 1 560639
7701046634	Bomba depresora Magnetti Marelli	GS	1 570345
7701045660	Bomba depresora Pierburg	GS	1 570346
7701030255	Jgo. cierre bancada (4)	GS	1 550658
7700724836	O'ring bomba vacío G 74 x 3	GS	1
	Arandela A 10 x 15 x 1.5 A	AL	1
	Arandela A 16 x 22 x 1.5 A	AL	1
	Arandela A 18 x 24 x 1.5 A	AL	2
	Arandela A 22 x 28 x 2 A	AL	1
	Kit de retenes completo		R560700
	Jgo. retén válvulas (8)	V	1 R560110V
	Retén bancada 85 x 105 x 8	V	1 R560111V
	Retén distribución 42 x 54 x 6	V	1 R570412V
	Retén árbol levas 25 x 42 x 7	V	1 R560113V
	Retén auxiliar 22 x 45 x 7	P	R560114P

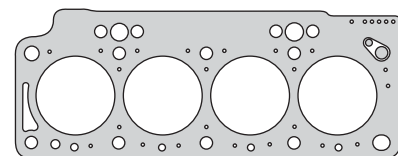

580107

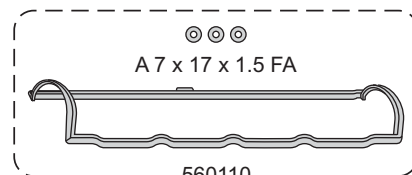

A 7 x 17 x 1.5 FA

560110

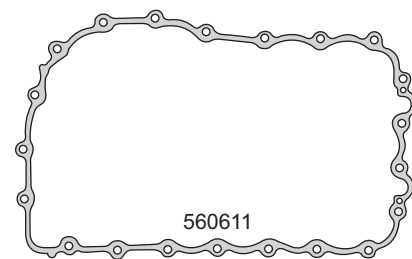

560611

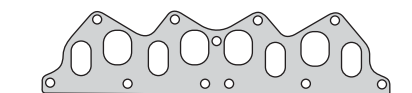

560115

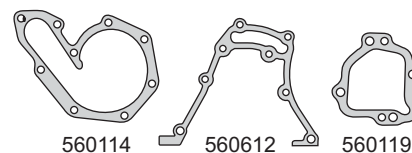

560114

560612

560119

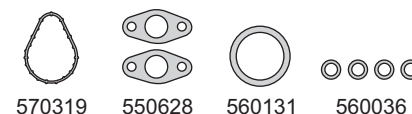

570319

550628

560131

560036

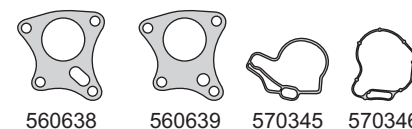

560638

560639

570345

570346



G 65 x 68 x 3.6

G 74 x 3

A 22 x 28 x 2 A

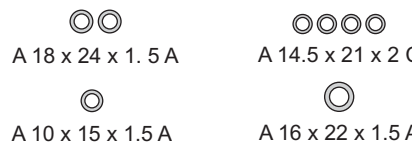

A 18 x 24 x 1.5 A

A 14.5 x 21 x 2 C

A 10 x 15 x 1.5 A

A 16 x 22 x 1.5 A

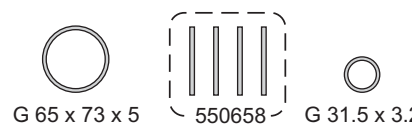

G 65 x 73 x 5

550658

G 31.5 x 3.2



R560111V



R570412V

R560113V

R560114P

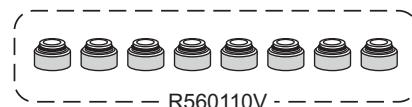

R560110V

RENAULT / KA

RENAULT



Motor/Engine	Cm³	HP	Ø
C1C 700/706	956	41	65
C1E 688/752/756	1108	45/49	70

Renault: Express 1985/93 - R9 - R11 1981/89
Super Cinco 1985/93

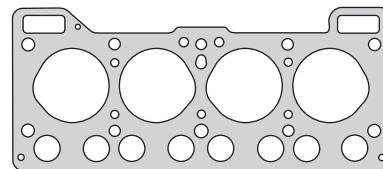

580207

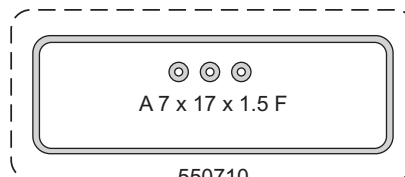

550710

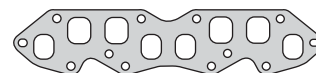

550815



550714

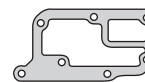

550719

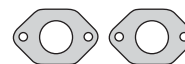

550725

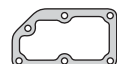

550331



550338



550737



06047



G 23.52 x 1.78

RENAULT / IKA

Nº OE	Descripción/Description	Mat.	Ref.
	Jgo. de juntas superior		580295
	Junta tapa cilindros Ø 72 ± 1.30	NFT 1	580207
	Jgo. tornillos tapa cilindros (HAS17038)		B550400
	Conj. junta tapa válvulas (4)	N 1	550710
	Bomba de agua	NB 1	550714
	Múltiple escape	FCH 1	550815
	Bomba de agua a block	NB 1	550719
	Junta base carburador	NB 2	550725
	Arandela A 7 x 17 x 1.5 F	NB 3	550430
	Placa bomba de agua	NB 1	550331
	Placa bomba de agua	NB 1	550737
	Junta distribuidor	NB 1	550338
	Junta base carburador	NB 2	06047
	O´ring G 23.52 x 1.78	GS 1	

RENAULT



Motor/Engine	Cm³	HP	Ø
F7P 720/722	1764	135/140	82
F7P 700/704	1764	133/137	82

Renault: Clio 1991/97 - R19 1989/96



Nº OE	Descripción/Description	Mat.	Ref.
	Jgo. de juntas superior		580495-R
	Junta tapa cilindros Ø 84 \pm 1.30 N.R.	NFT	1 570107
	Jgo. tornillos tapa cilin. (HAT55055/HAT55100)		B570100
	Junta tapa válvulas	NB	1 570110
	Termostato	NB	1 570136
	Múltiple escape	GS	1 560131
	Múltiple admisión	NFT	1 580415
	Múltiple admisión	NB	1 580417
	Arandela A 8 x 11 x 1C	CU	2
	O'ring G 36 x 3	GS	1
	Kit de retenes completo		R580400
	Jgo. retén válvulas (16)	V	1 R580410V
	Retén árbol levas 25 x 42 x 7	V	2 R560113V

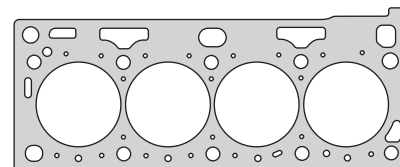

570107

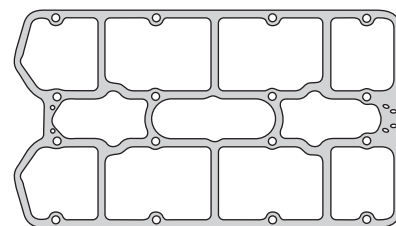

570110

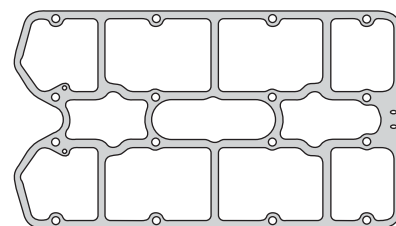

570136

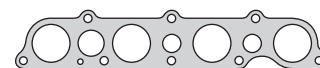

580415



580417



G 36 x 3



560131



A 8 x 11 x 1 C



R560113V

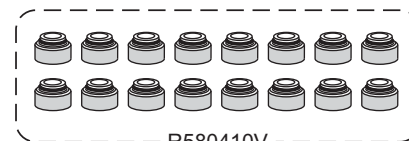

R580410V

RENAULT



Motor/Engine	Cm³	HP	Ø
810.02/05/09	1289	54/63	73
B130/B130S	1289	57	73

Renault: R12 1969/75 - R12TS 1973/75
 R12 - R15 1976/80 - R5 1974/84
 Rodeo 1980/81 - Estafette 1974/81

Volvo: 66 1973/76

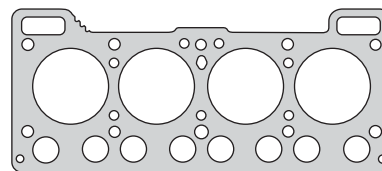

580507

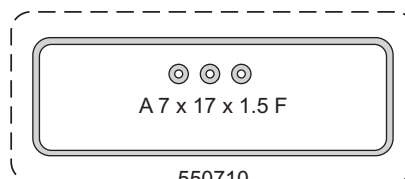

550710



550416



560214

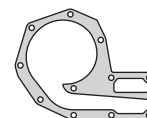

580514



550418

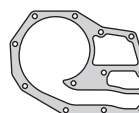

580519



560219

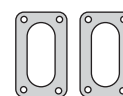

550625

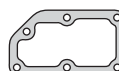

550331

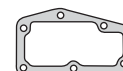

550332

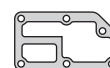

550737

Nº OE	Descripción/Description	Mat.	Ref.
	Jgo. de juntas superior		580595
	Junta tapa cilindros Ø 74 ± 1.30	NFT 1	580507
	Jgo. tornillos tapa cilindros (HAS17038)		B550400
	Conj. junta tapa válvulas (4)	NB 1	550710
	Tapa bomba de agua	NB 1	560214
	Bomba de agua	NB 1	580514
	Múltiple escape	NFT 1	550416
	Salida de escape	FCH 1	550418
	Placa bomba de agua	NB 1	560219
	Bomba de agua	NB 1	580519
	Base carburador	NB 2	550625
	Arandela A 7 x 17 x 1.5 FA	NB 3	550430
	Placa bomba de agua	NB 1	550331
	Placa bomba de agua	NB 1	550332
	Placa bomba de agua	NB 1	550737

RENAULT / IKA

RENAULT**taranto**

Motor/Engine	Cm ³	HP	Ø
C1J 782/788/760/764	1289	57	76

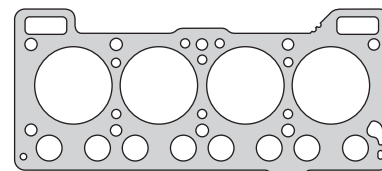
Renault: Super Cinco - R11 - R9 Turbo
1984/93

580607

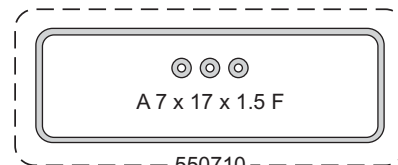

550710



550815



550714

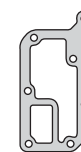

550719

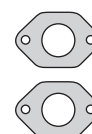

550725

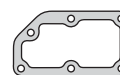

550331



550338

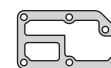

550737

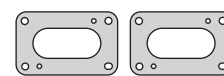

6047



G 23.52 x 1.78

Nº OE	Descripción/Description	Mat.	Ref.
	Jgo. de juntas superior		580695
	Junta tapa cilindros Ø 77 \pm 1.95	NFT 1	580607
	Jgo. tornillos tapa cilindros (HAS17038)		B550400
	Conj. junta tapa válvulas (4)	NB 1	550710
	Bomba de agua	NB 1	550714
	Múltiple escape	FCH 1	550815
	Bomba de agua a block	NB 1	550719
	Junta base carburador	NB 2	550725
	Arandela A 7 x 17 x 1.5 F	NB 3	550430
	Placa bomba de agua	NB 1	550331
	Placa bomba de agua	NB 1	550737
	Junta distribuidor	NB 1	550338
	Junta distribuidor	NB 1	550738
	Junta base carburador	NB 2	6047
	O´ring G 23.52 x 1.78	GS 1	

RENAULT



Motor/Engine	Cm³	HP	Ø
F8M 720/730/736/760 Iny. Indirecta	1595	55	78

Renault: Express 1987/96
Super Cinco 1988/96
R9 - R11 1988/89

DIESEL



Nº OE	Descripción/Description	Mat.	Ref.
	Jgo. de juntas para motor		560601-R
7700867871	Junta tapa cilindros Ø 79 \pm 1.75	NFT	580707-1M
7701039396	Junta tapa cilindros Ø 79 \pm 1.65	NFT	580707-2M
7701039397	Junta tapa cilindros Ø 79 \pm 1.85	NFT	580707-3M
	Jgo. tornillos tapa cilindros (HAE14038)		B560600
	Jgo. tornillos tapa cilindros (HAE14038)		B560600-1
7700743903	Conj. junta tapa válvulas (4)	N	560110
7700859751	Junta cárter para cárter de chapa	NFT	560111
8200105746	Frente motor para retén distribución	NB	560612
7700851213	Tapa bomba de agua	CB	560114
7700854867	Múltiple admisión y escape	FCH	560115
7700852434	Inferior árbol de levas	NB	560119
7701040923	Guarnición termostato	N	570319
	Arandela tapa bujía B 18 x 24 x 2.3 CN	CN	450029
7700736647	O'ring G 31.5 x 3.2	GS	560129
	Arandela tapa bujía B 16 x 22 x 2.4 CN	CN	450229
7703061078	Arandela tapa válvulas A 7 x 17 x 1.5 FA	NH	550430
7700718380	Anillo termostato	GS	560131
	Guarnición sintético G 65 x 68 x 3.6	GS	560132
	Guarnición sintético G 65 x 73 x 5	GS	560133
	Arandela para llamas	AC	560036
	Arandela A 14.5 x 21 x 2 C	CU	560136
7700859220	Bomba vacío	NB	560638
7700851849	Bomba vacío	NB	560639
	Arandela pico inyector	H	560641
7701030255	Jgo. cierre bancada (4)	GS	550658
	Arandela A 10 x 15 x 1.5 A	AL	
	Arandela A 22 x 28 x 2 A	AL	
	Arandela A 16 x 22 x 1.5 A	AL	
	Arandela A 18 x 24 x 1.5 A	AL	
7700724836	O'ring bomba vacío G 74 x 3	GS	
	Kit de retenes completo		R560600
	Jgo. retén válvulas (8)	V	R560110V
	Retén bancada 85 x 105 x 8	V	R560111V
	Retén distribución 50 x 68 x 10	V	R550612V
	Retén árbol levas 25 x 42 x 7	V	R560113V

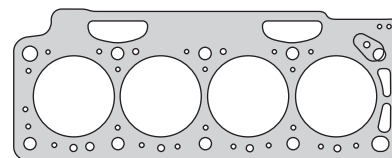

580707

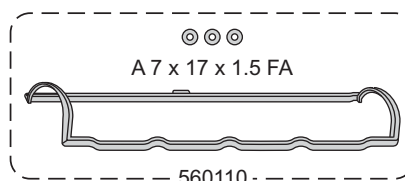

A 7 x 17 x 1.5 FA

560110

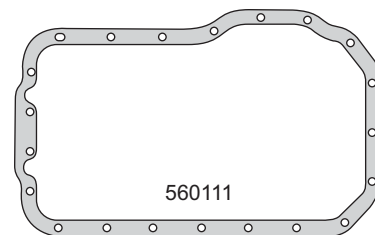

560111

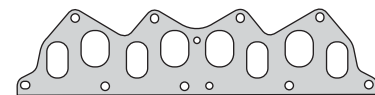

560115



560114

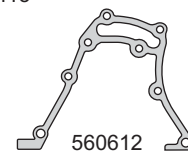

560612



560119



570319



560131



560036



560639



550658



560638



560641



G 65 x 68 x 3.6



G 31.5 x 3.2



G 65 x 73 x 5



G 74 x 3



A 18 x 24 x 1.5 A



A 16 x 22 X 1.5 A



A 14.5 x 21 x 2 C



A 10 x 15 x 1.5 A



A 22 x 28 x 2 A



R560111V



R550612V



R560113V



R560110V

RENAULT



Motor/Engine	Cm³	HP	Ø
F8QT	1870	90	80
F8Q 740/741/768	1870	90/93	80
F8Q 784/786	1870	90/93	80
D19T - D4192T	1870	90	80

Mitsubishi: Carisma TD 1997/...
Renault: R19DT 1991/96 - Megane DT 1996/97
 Scenic DT 1986/...
Volvo: 440TD - 460TD 1994/97
 V40TD - S40TD 1996/99



DIESEL

Nº OE	Descripción/Description	Mat.	Ref.
	Jgo. de juntas para motor		580901-R
	Jgo. de juntas superior	●	580995-1M
	Jgo. de juntas superior		580995-2M
	Jgo. de juntas superior	1	580995-3M
	Junta tapa de cilin. Ø 80.7 \times 1.50	NFT	580107-1M
	Junta tapa de cilin. Ø 80.7 \times 1.45	NFT	580107-2M
	Junta tapa de cilin. Ø 80.7 \times 1.60	NFT	580107-3M
	Jgo. tornillos tapa cilindros (HAE14038)		B570300
7700743903	Conj. junta tapa válvulas (4)	N	1 1 560110
7700859751	Junta cárter para cárter de chapa	NFT	1 1 560111
7700851213	Tapa bomba de agua	CB	1 1 560114
8200105746	Junta frente motor porta reten distribución	NB	1 1 560612
7700854867	Múltiple admisión y escape	FCH	1 1 580915
7700852434	Inferior árbol de levas	NB	1 1 560119
7701040923	Guarnición termostato	N	1 1 570319
770062283	Bomba alimentación	NB	550628
	Arandela tapa bujía B 18 x 24 x 2.3 CN	CN	2 450029
7700736647	O'ring G 31.5 x 3.2	GS	1 560129
	Arandela tapa bujía B 16 x 22 x 2.4 CN	CN	2 450229
7703061078	Arandela tapa válvulas A 7 x 17 x 1.5 F	NH	3 3 550430
7700718380	Anillo termostato	GS	1 1 560131
	Guarnición sintético G 65 x 68 x 3.6	GS	1 560132
	Guarnición sintético G 65 x 73 x 5	GS	1 560133
	Arandela especial A 22 x 28 x 3 CN	CN	1 560134
	Arandela especial B 10 x 15 x 2.4 CN	CN	1 560135
	Arandela para llamas	AC	4 4 560036
	Arandela A 14.5 x 21.5 x 2 C	CU	4 4 560136
	Arandela A 12 x 17 x 1 C	CU	560137
7700859220	Bomba vacío	NB	1 1 560638
7700851849	Bomba vacío	NB	1 1 560639
7700724836	O'ring bomba vacío G 74 x 3	GS	1
7701030255	Jgo. cierre bancada (4)	GS	1 550658
	Kit de retenes completo		R560600
	Jgo. retén válvulas (8)	V	1 R560110V
	Retén bancada 85 x 105 x 8	V	1 R560111V
	Retén distribución 50 x 68 x 10	V	1 R550612V
	Retén árbol levas 25 x 42 x 7	V	1 R560113V
	Retén auxiliar 22 x 45 x 7	P	R560114P

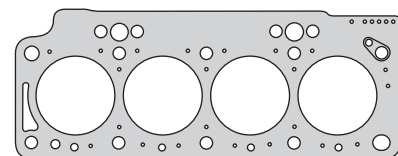

580107

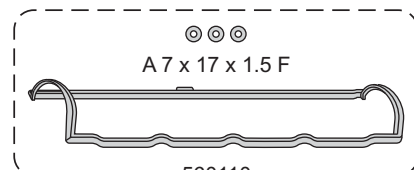

A7 x 17 x 1.5 F

560110

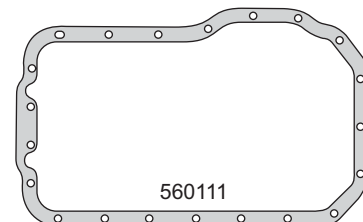

560111

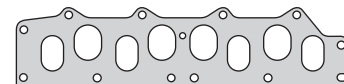

580915

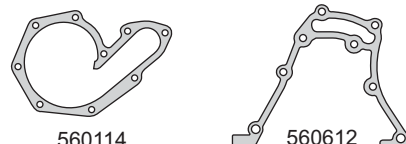

560114

560612



560119

570319

550628

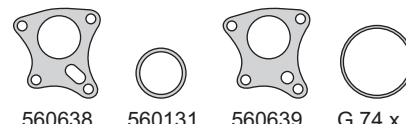

560638

560131

560639

G 74 x 3



A 14.5 x 21.5 x 2 C

A 12 x 17 x 1 C

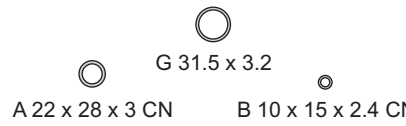

G 31.5 x 3.2

A 22 x 28 x 3 CN

B 10 x 15 x 2.4 CN



560036

B 18 x 24 x 2.3 CN

B 16 x 22 X 2.4 CN

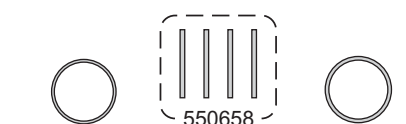

G 65 x 68 x 3.6

G 65 x 73 x 5

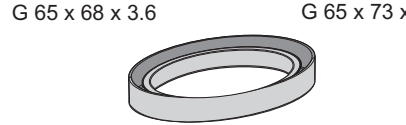

R560111V



R550612V

R560113V

R560114P



R560110V

RENAULT / KA

RENAULT



Motor/Engine	Cm³	HP	Ø
D4D	999	68/70	69
D4D 700	1149	75	69
D4F 702/706/712			
D4F 714 (DOHC) 16V			

Renault: Clio 2000/... - Kangoo 2003/...
Clio II - Kangoo .../00 - Twingo
Clio II - Kangoo 2001/...
Peugeot: 206 2000/...



RENAULT / IKA

Nº OE	Descripción/Description	Mat.	Ref.
7701473003	Jgo. de juntas para motor		581000-R MLS
	Jgo. de juntas superior (MLS)		581095 MLS
	Junta tapa cilindros Ø 70 \pm 1.20	NFT	581007
8200086698	Junta tapa cilindros Ø 70 \pm 0.35	MLS	1 1 581008
	Jgo. tornillos tapa cilindros (HAE12038)		B581000
7701049888	Junta tapa válvulas	N	1 1 581010
8200303331/1	Junta para cárter	NB	1 581011
	Bomba de aceite	NB	1 581012
8200237224	Bomba de agua	SLS	1 581014
8200310867	Múltiple escape	AC	1 1 581015
7701475823	Jgo. múltiple admisión (4)	N	1 1 581017
7701049890	Tapa caja motorizada admisión	N	1 1 581031
	Salida de agua	GS	1 581034
	Guarnición base filtro aceite bomba	N	1 1 581036
	Tapón árbol de levas	AC/N	1 1 581038
	Arandela tapón cárter A 16 x 22 x 1.5 C	CU	1
	O´ring G 21.95 x 1.78	GS	1
	Kit de retenes completo		R581000
	Jgo. retén válvulas - Hasta 2003 (16)	P	1 R581010P
	Jgo. retén válvulas - Desde 2004 (16)	V	1 R581710V
	Retén bancada 70 x 86 x 8	V	1 R570511V
	Retén distribución 32 x 44 x 6	V	1 R570512V
7701473495	Retén árbol de levas 28 x 47 x 5.5	V	1 R580013V

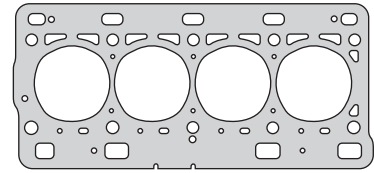

581008

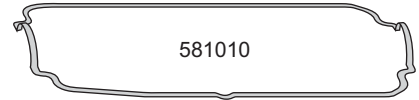

581010

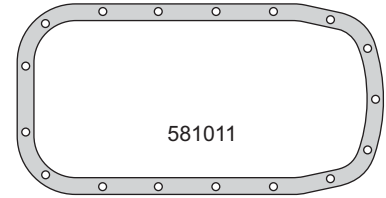

581011

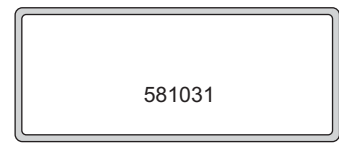

581031



581015

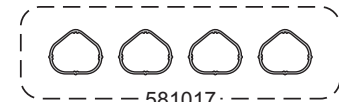

581017

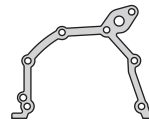

581012



581034



581014



581036



A 16 x 22 x 1.5 C



581038



G 21.95 x 1.78



R570511V



R570512V



R580013V

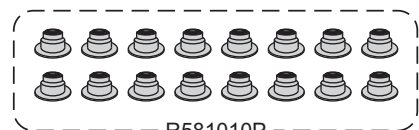

R581010P

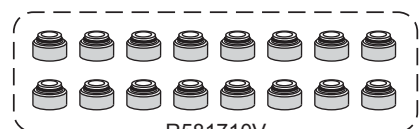

R581710V

RENAULT



Motor/Engine	Cm³	HP	Ø
K9K DCI (SOHC) 8V	1461	65/80	76
DIESEL			

Renault: Clio II DCI 2001/... Series 700/702/704/710
Kangoo DCI 2001/... Series 700/702
Megane DCI 2002/... Series 722/728/729/704/710
Symbol

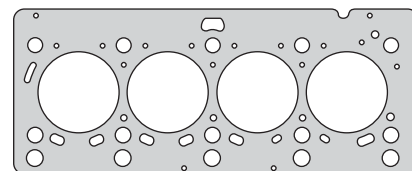

581207

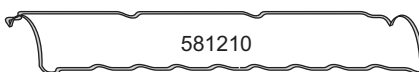

581210

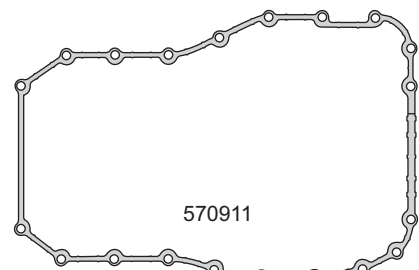

570911



581215



581212



581217

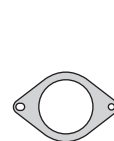

581218

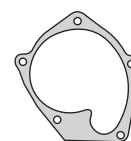

581214



581236



581238

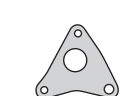

581240

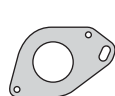

581241



G 18.72 x 2.62



G 29.74 x 3.53



G 25.07 x 2.62



G 17 x 2.6



G 29.74 x 3.53



G 36.17 x 2.62

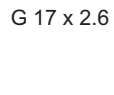

G 45 x 49 x 5

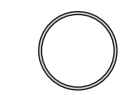

G 64 x 69 x 5

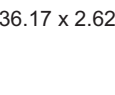

G 34.52 x 3.53



G 45 x 49 x 5



G 59.92 x 3.53



A 16 x 21 x 2 C



A 7.5 x 15 x 3 C



R550613V



R570011V



R570913V



R581210V

Nº OE	Descripción/Description	Mat.	Ref.
	Jgo. de juntas para motor		581201-R
	Jgo. de juntas superior		581295-1M
	Jgo. de juntas superior		581295-2M
	Jgo. de juntas superior		581295-3M
	Jta. tapa cilindros Ø 78 \pm 1.20	NFT 1	581207-1M
	Jta. tapa cilindros Ø 78 \pm 1.00	NFT	581207-2M
	Jta. tapa cilindros Ø 78 \pm 1.40	NFT	581207-3M
8200071111	Jta. tapa cilindros Ø 77.5 \pm 0.65	MLS	581208
7701473138	Jgo. tornillos tapa cilindros		B581200
8200117388	Junta tapa válvulas	N 1 1	581210
7700103687	Junta para cárter	N 1 1	570911
8800182129	Frente distribución	NB 1 1	581212
8200115278	Tapa bomba de agua	CB 1 1	581214
8200128551	Múltiple escape	AC 1 1	581215
	Anillo goma admisión G 31.3 x 35.6 x 3	GS 1 1	581217
	Salida de escape	AC 1 1	581218
	Descarga aceite turbo	NB 1 1	581236
7701047076	Anillo tapa llenado aceite G 45 x 49 x 5	GS 1 1	581237
8800073003	Bomba depresora	NB 1 1	581238
	Junta entrada turbo	NFT 1 1	581240
	Junta salida turbo catalizador	NFT 1 1	581241
	O´ring intermedio aceite G 59.92 x 3.53	GS 1 1	
	O´ring descarga G 17 x 2.6	S 1 1	
	O´ring tubo agua G 29.74 x 3.53	GS 1 1	
	O´ring entrada y salida tubo admisión G34.52 x 3.53	S 2 2	
	Anillo goma intermedio aceite G 64 x 69 x 5	GS 1 1	
	Arandela tapón cárter A 16 x 21 x 2 C	CU 1 1	
	Arandela pico inyector A 7.5 x 15 x 3 C	CU 4 4	
	O´ring G 18.72 x 2.62	GS 1 1	
	O´ring G 25.07 x 2.62	GS 1 1	
	O´ring G 36.17 x 2.62	GS 1 1	
	Kit de retenes completo		R581200
	Jgo. retén válvulas (8)	V 1 1	R581210V
7701473544	Retén bancada 80 x 100 x 8	V 1 1	R570011V
	Retén distribución 35 x 47 x 7	V 1 1	R550613V
	Retén árbol de levas 28 x 42 x 5	V 1 1	R570913V

RENAULT / K/A

RENAULT



Motor/Engine	Cm³	HP	Ø
K9K DCI (SOHC) 8V	1461	65/100	76
DIESEL			

Renault: Megane II - Sandero DCI Serie 794
Sandro Stepway DCI - Symbol DCI
Logan 2006/...



Nº OE	Descripción/Description	Mat.		Ref.
	Jgo. de juntas para motor			581301-R
770147337/1/1	Jgo. de juntas superior	●	●	581395
	Jta. tapa cilindros Ø 78 \pm 1.20	NFT		581307-1M
	Jta. tapa cilindros Ø 78 \pm 1.00	NFT		581307-2M
	Jta. tapa cilindros Ø 78 \pm 1.40	NFT		581307-3M
8200351353	Jta. tapa cilindros Ø77.5 \pm 0.65	MLS		581308
7701473138	Jgo. tornillos tapa cilindros (HAE18038)			B581200
8200117388	Junta tapa válvulas	GS	1 1	581210
8200379654	Junta para cárter	GS/AC		581311
8800182129	Frente distribución	NB		581212
8200115278	Tapa bomba de agua	CB		581214
8200414346	Múltiple escape	AC	1 1	581315
	Anillo goma admisión G 31.3 x 35.6 x 3	GS	1 1	581217
	Salida de escape	AC	1 1	581218
	Descarga aceite turbo	NB	1 1	581236
8800073003	Bomba depresora	NB	1 1	581238
	Junta entrada turbo	NFT	1 1	581240
	Junta salida turbo catalizador	NFT	1 1	581241
	O´ring intermedio aceite G 59.92 x 3.53	GS		1
	O´ring descarga G 17 x 2.6	S	1 1	
	O´ring tubo agua G 29.74 x 3.53	GS		1
	O´ring entrada y salida tubo admisión G 34.4 x 3.2	S	2 2	
	O´ring entrada aceite a turbo G 16 x 3	GS		
	Anillo goma intermedio aceite G 64 x 69 x 5	GS	1 1	
7701047876	Anillo goma G 45 x 49 x 5	GS	1 1	
	Arandela tapón cárter A 16 x 21 x 2 C	CU		1
	Arandela pico inyector A 7.5 x 15 x 3 C	CU	4 4	
7701473544	O´ring G 36.17 x 2.62	GS		1
	O´ring G 18.72 x 2.62	GS		1
	O´ring G 25.07 x 2.62	GS		1
	Kit de retenes completo			R581200
	Jgo. retén válvulas (8)	V	1	R581210V
	Retén bancada 80 x 100 x 8	V	1	R570011V
	Retén distribución 35 x 47 x 7	V	1	R550613V
	Retén árbol de levas 28 x 42 x 5	V	1	R570913V

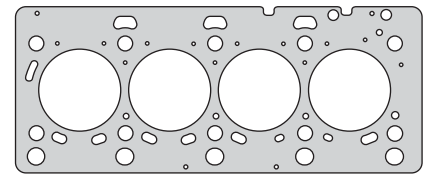

581308



581210

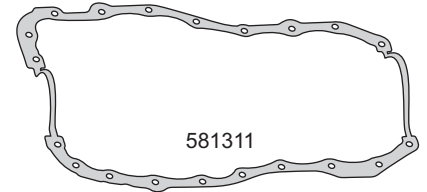

581311



581315



581212



581217

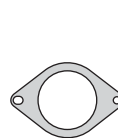

581218

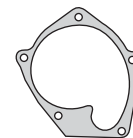

581214



581236



581238

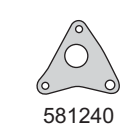

581240

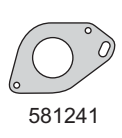

581241



G 17 x 2.6



G 29.74 x 3.53



G 36.17 x 2.62



G 45 x 49 x 5



G 64 x 69 x 5



G 34.4 x 3.2



A 16 x 21 x 2 C

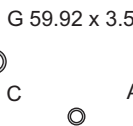

A 7.5 x 15 x 3 C



G 18.72 x 2.62



G 16 x 3

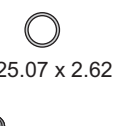

G 25.07 x 2.62

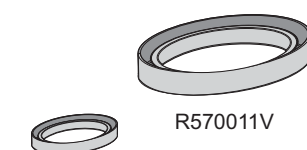

R570011V

R550613V

R570913V

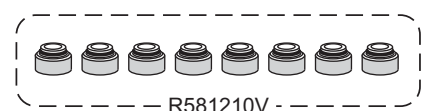

R581210V

RENAULT



Motor/Engine	Cm³	HP	Ø
G8T D/TD	2188	85/115	87

Renault: Laguna D 706/790 1996/...
Laguna TD 752/792/794 1996/...
Laguna TD 760/740 1997/...

DIESEL



Nº OE	Descripción/Description	Mat.	Ref.
7701469669	Jgo. de juntas para motor		581400-R
	Jgo. de juntas superior		581495
7700872860E	Junta tapa cilindros Ø 88 ± 1.80 N.R.	NFT 1 1	581407
	Jgo. de tornillos para tapa de cilindros		B581400
7700858850	Junta tapa válvulas	N 1 1	581410
7700857225	Junta para cárter	N 1 1	581411
	Múltiple escape	AC 1 1	581415
	Múltiple admisión	NB 1 1	581417
	Entre colectores admisión	NB 1 1	581431
	E.G.R.	AC 3 3	581432
	Tapa trasera tapa de cilindros	NH 1 1	581433
	Arandela parallamas	AC 4 4	560036
	O´ring G 50.52 x 1.78	GS 1	
	Arandela inyector A 16 x 21 x 1.50 C	CU 4 4	
	Kit de retenes completo		R581400
7700658325	Jgo. retén válvulas (12)	V 1	R581410V
7700859266	Retén bancada 93 x 108 x 7	V 1	R581411V
7700857118	Retén distribución 45 x 57 x 7	V 1	R581412V
7700857117	Retén árbol de levas 33 x 44 x 7	V 2	R581413V

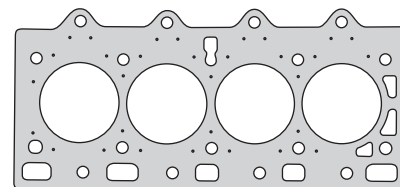

581407

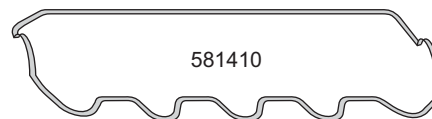

581410

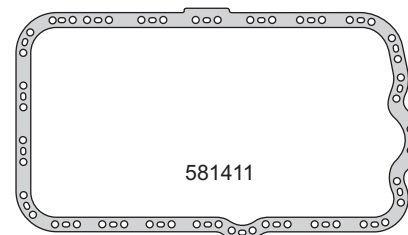

581411



581415



581417

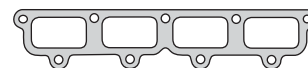

581431



581432

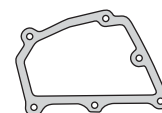

581433



560036



G 50.52 x 1.78



A 16 x 21 x 1.50 C



R581411V



R581412V



R581413V

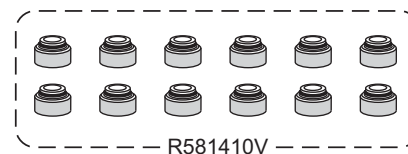

R581410V

RENAULT / KIA

RENAULT



Motor/Engine Cm³ HP Ø

D4F 728
D4F 708
(DOHC) 16V

Renault: 728 - Clio II 2005/...
708 - Twingo 2004/...



RENAULT / IKA

Nº OE	Descripción/Description	Mat.	Ref.
	Jgo. de juntas para motor		581700-R MLS
7701475822	Jgo. de juntas superior (MLS)	●	581795 MLS
	Junta tapa cilindros Ø 70 \pm 1.00	NFT	581007
8200151984	Junta tapa cilindros Ø 70 \pm 0.35	MLS	1 1 581008
	Jgo. tornillos tapa cilindros (HAE12038)		B581000
7701059314	Junta tapa válvulas	GS	1 1 581710
8200303331/1	Junta para cárter	NB	1 581011
	Bomba de aceite	NB	1 581012
8200233224	Bomba de agua	SLS	1 1 581014
8200310867	Múltiple escape	AC	1 1 581015
7701475823	Jgo. múltiple admisión (4)	N	1 581017
7701473164	Jgo. anillo protección bujías (4)	P	1 R581730P
	Junta sobre tapa válvulas	N	1 581031
	Salida bomba de agua	GS	1 1 581034
7701049890	Tapa caja motorizada delantera	GS	1 1 581036
	Arandela tapón cárter A 16 x 22 x 1.5 C	CU	1
	O´ring G 18.77 x 1.78	GS	1
	O´ring G 21.95 x 1.78		
	Kit de retenes completo		R581700
8200171215	Jgo. retén válvulas (16)	V	1 R581710V
7701473493	Retén bancada 70 x 86 x 8	V	1 R570511V
7701473494	Retén distribución 32 x 44 x 6	V	1 R570512V
7701473495	Retén auxiliar 28 x 47 x 5.5	V	1 R580013V

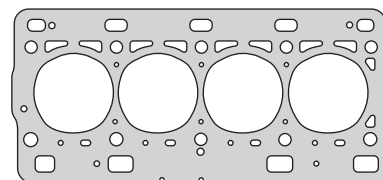

581008

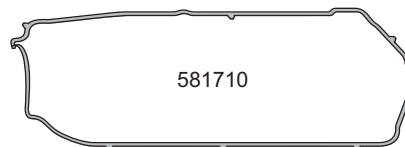

581710

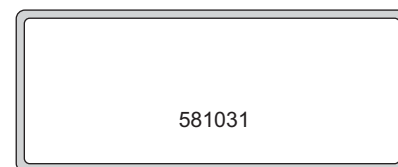

581031

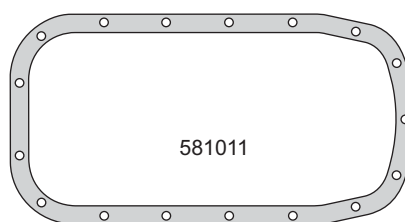

581011



581015

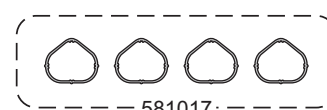

581017

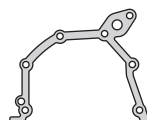

581012



581034



581014



581036



G 18.77 x 1.78



G 21.95 x 1.78



A 16 x 22 x 1.5 C



R581730P



R570511V



R570512V



R580013V

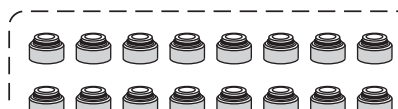

R581710V

RENAULT



Motor/Engine	Cm³	HP	Ø
G9U-720/724/730	2463	115	87
G9U-750/754	2463	115	87
G9U-730	2484	90	87
G9U-720/724	2499	90	87
G9U-750/754	2499	90	87

Nissan: Primastar - Interstar 2002/...
Renault: Master 2001/... - Trafic 2003/...



DIESEL

Nº OE	Descripción/Description	Mat.	Ref.
	Jgo. de juntas para motor		581800-R MLS
7701477813	Jgo. de juntas superior (MLS)		581895 MLS
8200406743	Junta tapa cilindros Ø 90 \pm 0.95 N.R.	MLS 1 1	581808
	Jgo. tornillos tapa cilindros (HAE18038)		B581800
7701472450	Conjunto junta tapa válvulas (9)	GS 1 1	581810
7700857225	Junta para cárter	GS 1 1	581411
8200265414	Tapa distribución	NB 1	581812
8200265416	Placa distribución	NB 1	581813
8200265416	Bomba de agua	SLS 1	581814
8200459643	Múltiple escape	AC 1 1	581815
7701472449	Jgo. guarnición admisión (8)	P 1 1	581817
7701040923	Guarnición termostato	GS 2 2	570319
7703065315	Guarnición goma	GS	581827
7701064298	Guarnición goma	GS 1	581829
	Arandela tapa de válvulas	GS 7 7	581830
7701048678	Guarnición metálica	P 1	581836
8200008387	Anillo con pestañas G 41 x 30	AC	581837
7700100987	Tapón ciego G 63.2 x 6	AC/N	581838
7703075328	Tapón ciego G 43 x 9	AC/N	581839
	Guarnición tapa válvulas	GS 1 1	581842
7701049483	O´ring G 68 x 2	N 1 1	
	O´ring G 50.52 x 1.78	P 1 1	
7701048962	O´ring G 45 x 3	GS 1 1	
7700864738	O´ring G 37.69 x 3.53	P 1 1	
	O´ring G 32 x 4	N 1 1	
7701049488	O´ring G 16 x 2	N 2 2	
7701471140	O´ring G 6 x 2	S 2 2	
	O´ring G 15.54 x 2.62	N 1	
	O´ring G 20.3 x 2.62	N 1	
	O´ring G 17.17 x 1.78	T 1	
	Arandela A 10 x 13 x 2.5 C	CU 2 2	
	Arandela pico inyector A 7 x 15 x 3 C	CU 4 4	
	Arandela tapón cárter A 16 x 22 x 1.5 A	AL 1	
	Kit de retenes completo		R581800
	Jgo. retén válvulas (16)	V 1	R581810V
7700859266	Retén bancada trasera 93 x 108 x 7	V 1	R581811V
7700103945	Retén distribución 60 x 75 x 7	V 1	R581812V
7700101348	Retén árbol de levas 30 x 42 x 7	V 2	R260113V
7700103946	Retén auxiliar distribución 70 x 85 x 7	V 1	R581813V

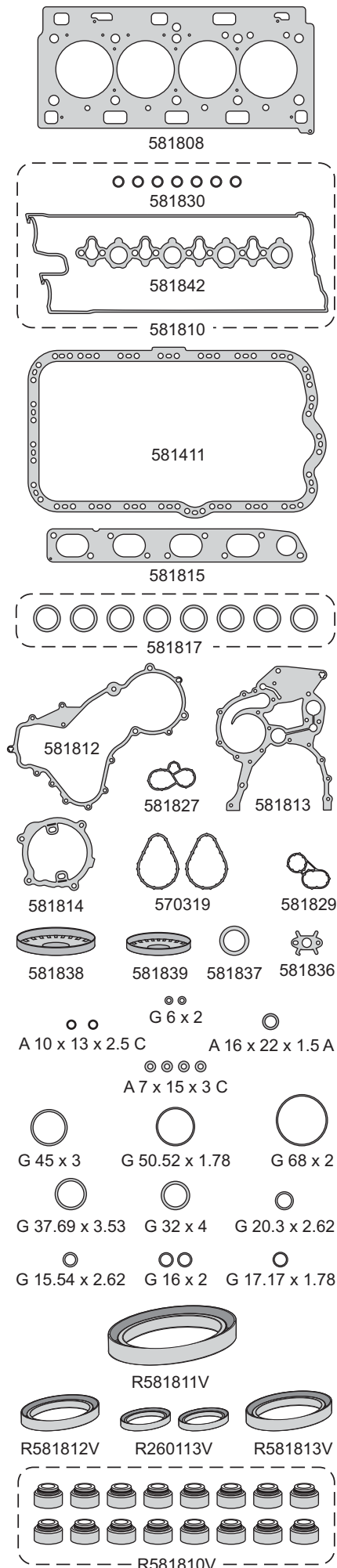

RENAULT / K/A

RENAULT



Motor/Engine	Cm ³	HP	Ø
2TR (DOHC) 16V	2488	170	89
DIESEL			

Renault: Koleos 4x2/4x4



RENAULT / IKA

Nº OE	Descripción/Description	Mat.	Ref.
	Jgo. de juntas para motor	●	582100-R-MLS
11044-ET80A	Junta tapa cilindros Ø 89.5 ± 0.65	MLS	1 903508
11056AR202	Jgo. de tornillos para tapa de cilindros		B903500
	Sellador líquido - caucho de silicona		TRN0280R
13270-JG30A	Junta tapa válvulas	GS	1 582110
	Múltiple escape	AC	1 582115
14035-JG35A	Múltiple admisión	SLS	1 582117
14035-JA05A	Múltiple admisión	GS	1 582117-1
14036-JA00A	Salida de escape	AC	1 582118
	Bomba de agua	SLS	1 903514
	Termostato	SLS	1 903519
	Base filtro aceite	SLS	1 582127
	Junta	SLS	1 903531
	Junta	SLS	1 903532
	O´ring G 7.52 x 3.53	S	4
16618-AX200	O´ring G 8 x 3	V	
	O´ring G 12.37 x 2.62	GS	1
	O´ring G 17.12 x 2.62	GS	2
	O´ring G 18 x 3	GS	1
	O´ring G 24.99 x 3.53	GS	1
	O´ring G 34.52 x 3.53	GS	1
	O´ring G 32 x 3	GS	1
	O´ring G 20.3 x 2.62	GS	1
	Kit de retenes completo		R582100
1320784A00	Jgo. retén válvulas (16)	P	1 R903510P
12279-AD200	Retén bancada 84 x 104 x 11	P	1 R902111P
13510-0Z400	Retén distribución 46 x 58 x 7	P	1 R902512P

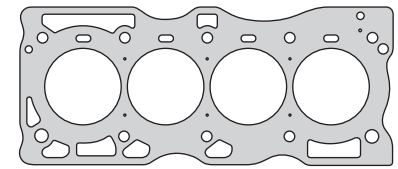

903508

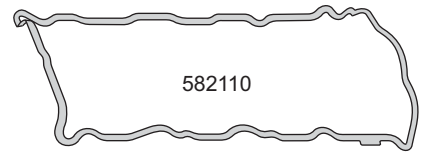

582110



582115



582117



582117-1



582118



903514



903519

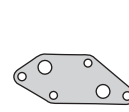

582127



903531

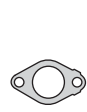

903532



G 7.52 x 3.53



G 12.37 x 2.62



17.12 x 2.62



G 8 x 3



G 24.99 x 3.53



G 20.3 x 2.62



G 34.52 x 3.53



G 18 x 3



G 32 x 3



R902111P



R902512P

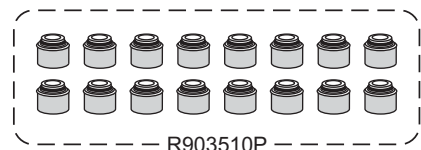

R903510P

RENAULT



Motor/Engine Cm³ HP Ø

M4R 714
(DOHC) 16V **1998** **84**

Renault: Fluence - Megane III 2011/...



Nº OE	Descripción/Description	Mat.	Ref.
	Jgo. de juntas para motor		582200-R MLS
10101-EN	Jta. tapa cilindros Ø 84.5 ±0.48	MLS	1 903408
11056-EN200	Jgo. de tornillos para tapa de cilindro		B903400
13270-ET000	Junta tapa válvulas	GS	1 903410
11110-ET010/1	Junta cárter inferior	NB	1 903411
21014-ET00A	Bomba de agua	SLS	1 903414
14036-ED800	Múltiple escape	MLS	1 903415
16121-16900	Múltiple admisión	SLS	1 582217
20695-8H310	Salida de escape	GFT	903418
20695-ED10A	Salida de escape a catalizador	GFT	903418-1
11062-ET00A	Salida agua base termostato	SLS	1 903419
20691-77A00	Salida de catalizador a silenciador	CHA	903428
16175-EL00A	Guarnición goma	GS	1 903430
13050-ET000	Guarnición termostato	GS	1 903432
21049-ET01A	Guarnición goma entrada agua	GS	903433
21049-6N220	Sello goma	GS	903434
15066-EN200	O´ring G 20.30 x 2.62	GS	1
22131-ED000	O´ring G 16 x 2.5	GS	
	O´ring G 13.11 x 2.62	GS	1
15066-4W000	O´ring G 9.19 x 2.62	GS	1
16618-FU460	O´ring G 7.52 x 3.53	GS	8
	Arandela A 20 x 26 x 1 A	AL	1
	Arandela especial A 11.5 x 17.5 x 4 C	CU	
	Kit de retenes completo		R903400
13207-ET000	Jgo. retén válvulas (16)	P	1 R902110P
12279-ET000	Retén bancada trasera 84 x 117 x 8.5	V	1 R903411V
13510-6N200	Retén frente motor 46 x 58 x 7	P	1 R902512P

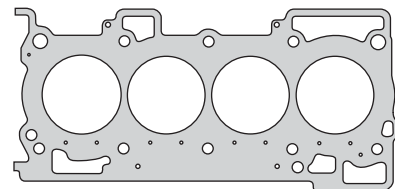

903408

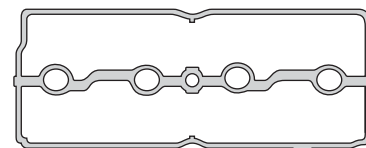

903410

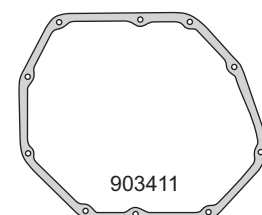

903411



903415



582217



903414

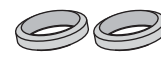

903418-1



903419



903428



903419



903430



903433



903434



903432



G 20.30 x 2.62



A 20 x 26 x 1 A



A 11.5 x 17.5 x 4 C



G 7.52 x 3.53



G 9.19 x 2.62



G 13.11 x 2.62



G 16 x 2.5



R902512P



R903411V

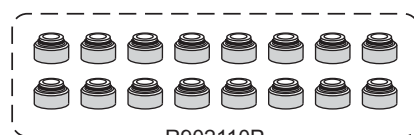

R902110P

RENAULT / KA

RENAULT



Motor/Engine	Cm³	HP	Ø
M9R 700/740	1995	150	84
M9R 780/782/784	1995	114	84
M9R 786/88 (DOHC) 16V	1995	90	84

Opel Vivaro CDTI 2006/08 - 2008/...
Renault: Espace IV 2006/... - Laguna II .../2005
 Megane II 2006/10 - Koleos

DIESEL

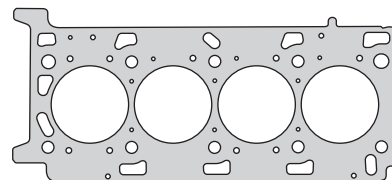

582308

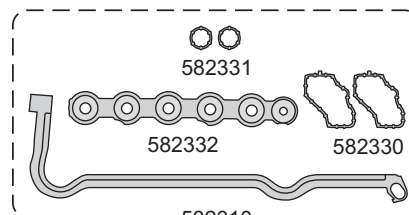

582331

582332

582330

582310



582315



582317



582314



582318



582319



582327



582328



582334



G 18 x 3

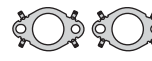

582335



G 3 x 1.60



A 8.4 x 17 x 1.20 A

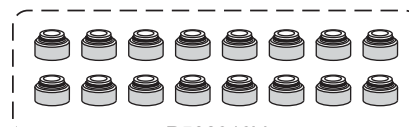

R582310V

Nº OE	Descripción/Description	Mat.	Ref.
	Jgo. de juntas para motor	●	582300-R MLS
	Junta tapa cilindros Ø 85 ± 0.80	MLS 1	582308
	Jgo. tornillos tapa cilindros (HAE18038)		B581800
	Sellador líquido - caucho de silicona		TRN0280R
	Conj. junta tapa válvulas (6)	GS 1	582310
	Bomba de agua G 64 x 3	GS 1	582314
	Múltiple escape	AC 1	582315
	Múltiple admisión	SLS 1	582317
	Salida de escape	AC 2	582318
	Junta termostato	GS 1	582319
	Junta bomba de aceite G 54 x 3	GS 1	582327
	Junta	SLS 1	582328
	Guarnición goma	GS 2	582330
	Guarnición goma	GS 2	582331
	Guarnición goma	GS 1	582332
	Junta	AC 1	582334
	Junta válvula EGR	AC 2	582335
	Arandela A 8.4 x 17 x 1.2 A	AL 4	
	O´ring G 3 x 1.60	GS 4	
	O´ring G 18 x 3	GS 1	
	Jgo. retén válvulas (16)	V 1	R582310V

RENAULT / IKA



MOTORES NAFTA - DIESEL

430007

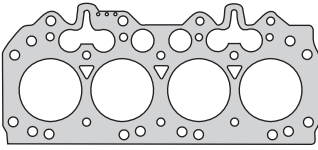

Código	Ø	≠	Kit Bulón
430007-1M	92.0	1.37	B430000-1 (HAS19038)
430007-2M	92.0	1.48	
430007-3M	92.0	1.59	
430007-4M	92.0	1.70	

Modelo	Range Rover TDI - Discovery TDI - Defender TDI 1990/94 - 1994/98
Motor	2495cc. 200/300 TDI 112HP Ø90.5 - DIESEL (430001-R) pág. 314

430008

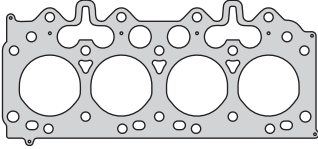

Código	Ø	≠	Kit Bulón
430008-1M	92.0	1.30	B430000-1 (HAS19038)
430008-2M	92.0	1.40	
430008-3M	92.0	1.50	

Modelo	Range Rover TDI - Discovery TDI - Defender TDI 1990/94 - 1994/98
Motor	2495cc. 200/300 TDI 112HP Ø90.5 - DIESEL (430001-R) pág. 314

460307

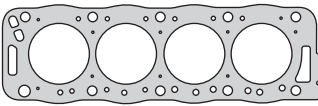

Código	Ø	≠	Kit Bulón
460307-1M	84.0	1.50	B460300 (HAT55055) (HAT55100)
460307-2M	84.0	1.60	
460307-3M	84.0	1.70	
460307-4M	84.0	1.80	

Modelo	218 - 418 1991/96
Motor	1905cc. XUD9A 67HP Ø83 - DIESEL (460301-R) pág. 364

470307 - 470308

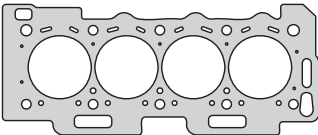

Código	Ø	≠	Kit Bulón
470307	78.0	1.80	B470300 (HAE14038)
470308		1.60	

Modelo	115TD 1995/98
Motor	1527cc. TUD5 (VJZ) 58HP Ø77 - DIESEL (470300-R) pág. 376

470707

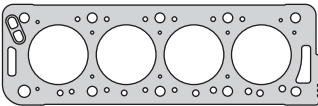

Código	Ø	≠	Kit Bulón
470707-2M	82.0	1.65	B470700 (HAT55055) (HAT55100)
470707-3M		1.80	

Modelo	218 TD - 418 TD 1991/96 - Tourer TD 1996/...
Motor	1769cc. XUD7T/TE 88HP Ø80 - DIESEL (460301-R) pág. 380

500507

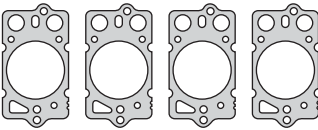

Código	Ø	≠	Kit Bulón
500507-SM	98.0	1.55	
500507-2M		1.60	
500507-1M		1.80	

Modelo	Range Rover TD 1986/92 - 1989/92
Motor	2393cc. VM492HT 113HP Ø92 - DIESEL 2499cc. HR924HR 121HP Ø92 - DIESEL (500401) pág. 455

520307

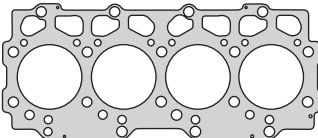

Código	Ø	≠	Kit Bulón
520307-SM	95.0	1.40	B520300 (HAS14038)
520307-1M		1.50	
520307-2M		1.60	

Modelo	825 TD 1996/99
Motor	2499cc. VM425TD 121HP Ø92 - DIESEL (520301-R) pág. 456

520308

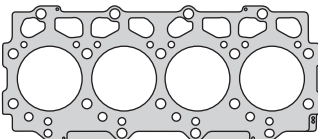

Código	Ø	≠	Kit Bulón
520308-SM	95.0	1.42	B520300 (HAS14038)
520308-1M		1.52	
520308-2M		1.62	

Modelo	825 TD 1996/99
Motor	2499cc. VM425TD 121HP Ø92 - DIESEL (520301-R) pág. 456

860007 - 860008

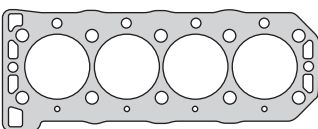

Código	Ø	≠	Kit Bulón
860007	83.0	1.80	B860000 (HAE12038)
860008		0.41	

Modelo	Metro - 111 1990/94 - 111 1995/98
Motor	1120cc. 11K8 8V 60HP - 1396cc. 14K8 8V 75HP Ø75 (860000-R) pág. 451



MOTORES NAFTA - DIESEL

860007 - 860008

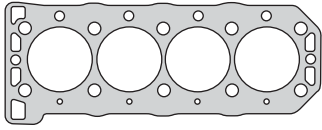

Código	Ø	≠	Kit Bulón
860007	83.0	1.80	B860000 (HAE12038)
860008	82.5	0.41	

Modelo	Motor
214/414 1995/99 - 216/416 1996/99 - 25/45 1999/...	200 Vi 218 Coupe 1995/...
	1396cc. 14K16 (DOHC) 16V 103HP Ø75 1589cc. K16 (DOHC) 16V 111HP Ø80 1796cc. 18K16 (DOHC) 16V 120/145HP Ø80 (860100-R) pág. 452

860207

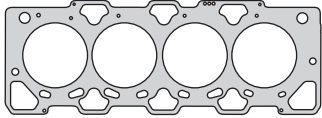

Código	Ø	≠	Kit Bulón
860207-1M	86.0	1.05	
860207-2M	86.0	1.20	
860207-3M	86.0	1.40	

Modelo	Motor
Freelander TCIE 1997/00 - 620 1995/99- 420TD - 220TD 620TD 1995/99 - 25TD - 45TD 1999/...	
	1994cc. 20T 97HP - 20T2N 105HP Ø84.5 - DIESEL (860201-R)

860208

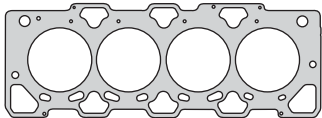

Código	Ø	≠	Kit Bulón
860208-1M	86.0	1.10	
860208-2M	86.0	1.20	
860208-3M	86.0	1.35	

Modelo	Motor
Freelander TCIE 1997/00 - 620 1995/99- 420TD - 220TD 620TD 1995/99 - 25TD - 45TD 1999/...	
	1994cc. 20T 97HP - 20T2N 105HP Ø84.5 - DIESEL (860201-R)

860307

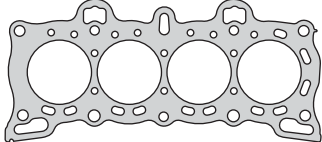

Código	Ø	≠	Kit Bulón
860307	76.5	1.30	B860300 (HAS14038)

Modelo	Motor
216 - 416 1989/92	
	1590cc. D16A7 (SOHC) 16V 116HP Ø75 (860300-R)

860407 - 860408

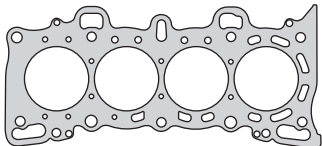

Código	Ø	≠	Kit Bulón
860407	76.0	1.30	B860400 (HAS14038)
860408	76.0	0.70	

Modelo	Motor
216 - 416 16V 1992/94	
	1590cc. D16A6 111HP Ø75 (860400-R)

860808

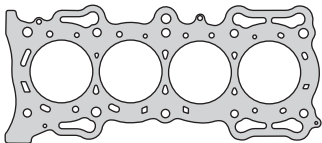

Código	Ø	≠	Kit Bulón
860808	86.0	1.35	

Modelo	Motor
618 1996/99 - 620 - 620 SI 1993/97	
	1850cc. F18A3 (SOHC) 16V 115HP Ø85 1997cc. F20Z1 131HP - F20Z2 (SOHC) 115HP Ø85 (860800-R)

861008

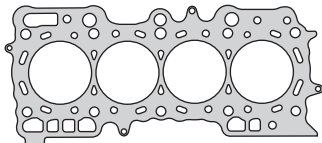

Código	Ø	≠	Kit Bulón
861008	87.5	1.35	

Modelo	Motor
623 1993/97	
	2259cc. H23A3 (DOHC) 16V 158HP Ø87 (861000-R)

890607

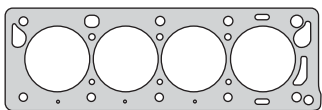

Código	Ø	≠	Kit Bulón
890607	88.6	1.70	

Modelo	Motor
820 - 820i - 820Si 16V Inyección Multipunto 1986/90	
	1994cc. 20HD/M16 (DOHC) 16V 103/120HP Ø84.45 (890600-R) pág. 453

981207

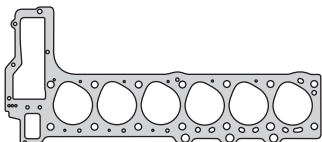

Código	Ø	≠	Kit Bulón
981207-2M	81.0	1.68	B980200 (HAE14038)
981207-3M	81.0	1.87	

Modelo	Motor
Ranger Rover Turbo 1994/02	
	2498cc. D256TM 136HP Ø80 - DIESEL (981201-R) pág. 7

ROVER



Motor/Engine	Cm³	HP	Ø
11K8	1120	60	75
14K8	1396	75	75

Rover: Metro 111 1990/94 - 111 1995/98
 Metro 111 - 214 1990/94
 114 - 214 1995/99



Nº OE	Descripción/Description	Mat.	Ref.
GUG701585	Jgo. de juntas para motor	●	860000-R
	Jta. tapa cilindros Ø 83 \pm 1.80	NFT	860007
GUG702576	Jta. tapa cilindros Ø 82.5 \pm 0.41	ACG	1 860008
WAN2293G	Jgo. tornillos tapa cilindros (HAE12038)		B860000
	Junta tapa de válvulas	GS	1 860010
GUG7030445G	Junta para cárter	GS	1 860011
GUG4002146	Múltiple admisión	NH	1 860017
LKE101640	Múltiple escape	NFT	1 860015
GUG705608	Salida de agua a tapa cilindros	NH	1 860019
	Entre inyector monopunto admisión	NH	1 860025
LVG100330	Respaldo bomba aceite	NB	1 860027
LVG100063	Varilla medida nivel aceite	NB	1 860039
LVH10010	Base filtro aceite a block	NB	1 860036
LKX100050	Tubo plástico 34 x 28 x 19	P	1 860040
	O´ring camisa cilindros G 76 x 1.5	V	8
	O´ring G 83 x 3.5	N	1
	O´ring G 33 x 3	N	1
	O´ring G 50 x 3	N	2
	O´ring G 42 x 3.5	N	1
	O´ring G 140 x 5	N	1
	O´ring G 4.7 x 1.70	GS	6
	Arandela A 13 x 19 x 1.5 C	CU	1
	Kit de retenes completo		R860000
	Jgo. retén válvulas (8)	V	1 R860010V
	Retén bancada 79 x 126 x 1.25	V	1 R860011V
	Retén distribución 27 x 39.5 x 7	V	1 R860012V
	Retén árbol de levas 30 x 40 x 7 (bidireccional)	S	2 R860013-2S

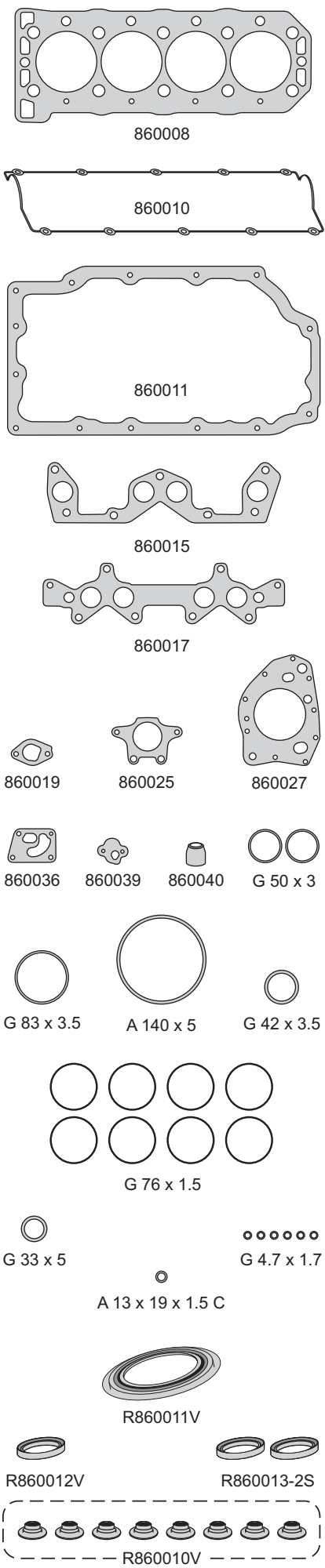

ROVER

ROVER



Motor/Engine	Cm³	HP	Ø
14K16	1396	103	75
K16	1589	111	80
18K16 (DOHC) 16V	1796	120/145	80

Rover: 214 - 414 1995/99 - 25 - 45 1999/...
216 - 416 1996/99 - 200 Vi - 218 Coupe
1995/...



ROVER

Nº OE	Descripción/Description	Mat.	Ref.
GUG701125	Jgo. de juntas para motor		860100-R
	Jta. tapa cilindros Ø 83 \pm 1.80		860007
GUG7025HG	Jta. tapa cilindros Ø 82.5 \pm 0.41	ACG 1	860008
WAN2293	Jgo. tornillos tapa cilindros (HAE12038)		B860000
LVP100630	Junta tapa válvula	SLS 1	860110
GUG7030445G	Junta para cárter	GS 1	860111
GUG704430MG	Múltiple escape - Todos	NFT 1	860115
GUG704004ME	Múltiple admisión 1.4	NB 1	860117
GUG701074MG	Múltiple admisión inyección 1.8	NB 1	860117-1
LKJ101110LK	Junta admisión 1.4/1.6/1.8 1996/...	GS 1	860117-2
GUG705608GM	Junta termostato 1.4/1.6	NB 1	860119
LVG100330	Respaldo bomba aceite	NB 1	860027
GUG704817MG	Entre colectores admisión 1.4 hasta 1995	NB 1	860131
LZV1101	Junta bomba inyectora	NB 1	860132
L VH10010	Base filtro aceite a block	NB 1	860036
LVJ10006V	Varilla medición aceite	NB 1	860139
LQX100050	Tubo plástico-instalador retén bomba aceite	PLAST	860040
	O´ring G 32 x 3	GS 2	
	O´ring G 82 x 3.5	GS 1	
	O´ring G 17.17 x 1.78	GS 1	
	O´ring G 75.92 x 1.78	GS 8	
	Arandela A 13 x 19 x 2.5 C	CU 1	
	Kit de retenes completo		R860100
LUB100350	Jgo. retén válvulas (16)	V 1	R860110V
LUF000050	Retén bancada 79 x 126 x 1.25	V 1	R860011V
LKX100040	Retén distribución 27 x 39.5 x 7	V 1	R860012V
LUC100290	Retén árbol levas del. giro derecho 30 x 40 x 7	V 2	R860013-1V
LUC100220	Retén árbol levas tras. giro izquierdo 30 x 40 x 7	V 2	R860013-2V

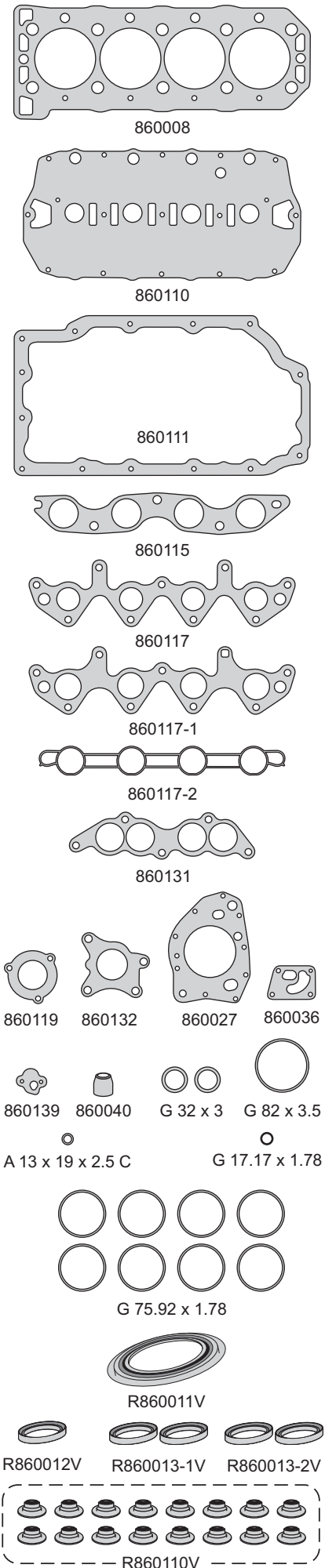

ROVER



Motor/Engine	Cm³	HP	Ø
20HD-M16 (DOHC) 16V	1994	103/120	84.45

Rover: 820 - 820i - 820Si 16V
Inyección Multipunto 1986/90



Nº OE	Descripción/Description	Mat.	Ref.
	Jgo. de juntas para motor		890600-R
	Junta tapa cilindros Ø 88.6 ± 1.70	NFT	1 890607
	Conjunto junta tapa válvulas (2)	NH	1 890610
	Junta para cárter	NH	1 890611
	Junta placa trasera motor	NB	1 890612
	Junta porta filtro bomba aceite delantero	NB	1 890613
	Múltiple escape	FCH	1 890615
	Múltiple admisión	NH	1 890617
	Junta base termostato	CB	1 890619
	Junta acople inyección	CB	1 890629
	Junta acople termostato	CB	1 890630
	Junta acople admisión	CB	1 890631
	O'ring G 8 x 3.5	GS	8
	O'ring G 6 x 4.8	GS	1
	O'ring G 18 x 2	GS	1
	O'ring G 20 x 2.4	GS	1
	Kit de retenes completo		R890600
	Jgo. retén válvulas (16)	P	1 R890610P
	Retén bancada 88.9 x 104.7 x 9.30	V	1 R890611V
	Retén distribución 35 x 45 x 7	V	1 R890612V
	Retén árbol de levas 40 x 52 x 7	V	4 R890613V

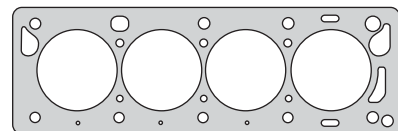

890607

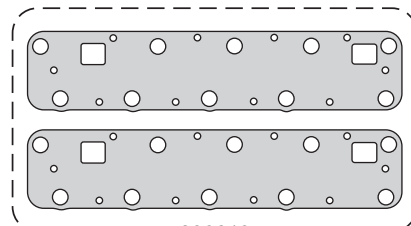

890610

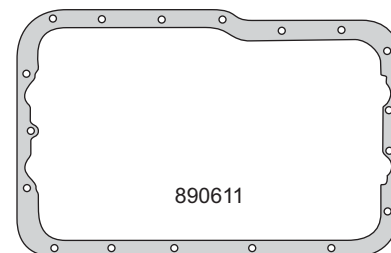

890611



890612



890613

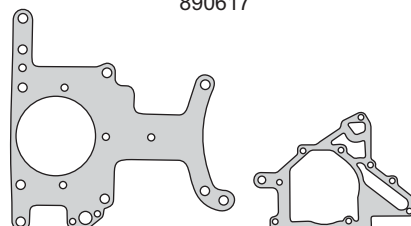

890615

890613

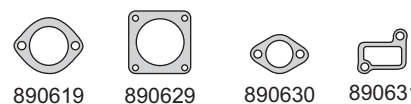

890619

890629

890630

890631



G 6 x 4.8

G 18 x 2

G 20 x 2.4



G 8 x 3.5



R890611V

R890612V

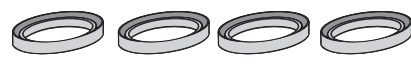

R890613V

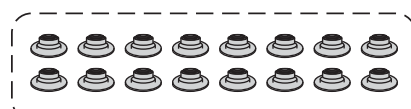

R890610P



taranto

Para garantizar un trabajo óptimo, utilice el Kit de Herramientas Especiales HAK12-38, con su completa línea de puntas en todas la versiones aplicables para cada modelo de cabeza de ajuste.



KIT HAK12-38

Tubos Hexagonales

6 PT Socket



Tubos Torx

Torx Socket



Tubos Estriados

12 PT Socket



Tubos con Punta Torx

Torx Socket Bit



Tubos con Punta Ribe

Ribe Socket Bit



Tubos con Punta Estriada

Torx Spline Socket Bit



Tubos con Punta Hexagonal

Hex. Socket Bit



Goniometro - Torquimetro Taranto.

Diseñado especialmente para facilitar el apriete de los tornillos de tapa de cilindros.

- HTORQ-110 - Herramienta Torquimetro 19-110NM
- HTORQ-210 - Herramienta Torquimetro 40-210NM
- HTORQ-350 - Herramienta Torquimetro 60-350NM
- HGONIOMETRO - Herramienta de Ajuste Angular - Goniometro
- HGONIOMETRO-M - Herramienta de Ajuste Angular - Goniometro Magnético



VM BORGWARD



Motor/Engine	Cm³	HP	Ø
VM80A	1995	95	88
VM81A/492HT	2393	110/113	92
VM84A/08B/07B	2499	114/125	92
VM31B/32B-SCB	2499	125/115	92
VM66A/84A	2499	108/114	92
HR425CLI <small>DIESEL</small>	2499	118	92

Alfa Romeo: 75/90TD - 155/164TD 1984/...
Chrysler: Voyager - Grand Voyager TD 92/94
Ford: Scorpio - Granada TDI - Falcon
Rover: Range Rover TD 1986/89, 1989/92
Toyota: Land Cruiser 70/250 TD 1987/89 - 1990/93

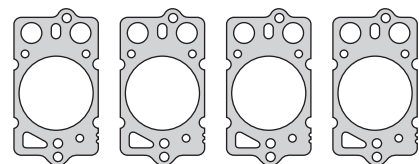

500507

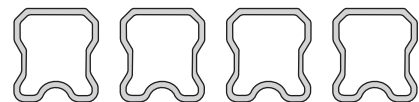

500410

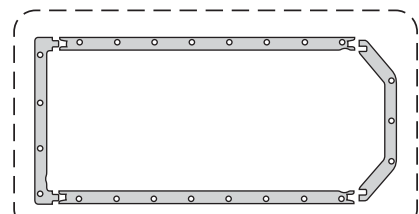

500411

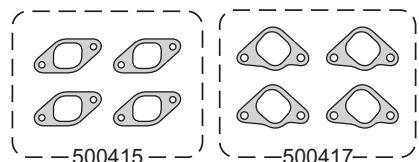

500415

500417

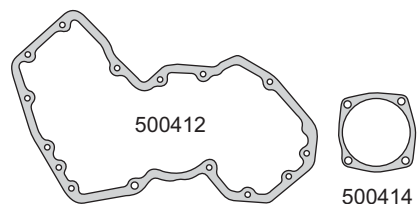

500412

500414



500418

500427

500428

500430



500434

500429

500433



500246

G 63.22 x 1.78

500540



G 31.34 x 3.53

G 26.57 x 3.53



G 34.52 x 3.53

G 66.4 x 1.78

G 158.42 x 2.62



500470-0.20



500473

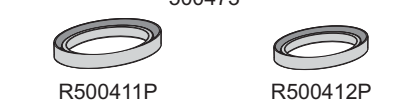

R500411P

R500412P

Nº OE	Descripción/Description	Mat.	Ref.
	Jgo. de juntas para motor		500401
22030460B	Junta tapa cilindros Ø 98 \pm 1.55	NFT 4	500507-SM
22032043A	Junta tapa cilindros Ø 98 \pm 1.60	NFT 4	500507-2M
22030461B	Junta tapa cilindros Ø 98 \pm 1.80	NFT 4	500507-1M
B2031007A	Junta tapa de válvulas	NH 4	500410
22030365A	Jgo. junta para cárter (4)	NB 1	500411
22030363A	Tapa distribución	NB 1	500412
20030371A	Bomba de agua	NB 1	500414
22030403A	Jgo. múltiple escape (4)	NFT 1	500415
22030350A	Jgo. múltiple admisión (4)	NB 1	500417
22022025A	Salida de escape	NFT 1	500418
22030448A	Salida de escape a turbo	CHA	500518
46320525A	O'ring bomba aceite G 66.34 x 2.62	GS 1	500427
B6321000A	O'ring bomba combustible G 39.34 x 2.62	GS 1	500428
22030338A	Entre tapa cilindros y tubo recolector agua	NB 4	500429
22030356A	Entrada aceite turbo	NB 1	500430
22030162A	Conexión cuentavueltas	NB 1	500433
46320069A	O'ring cigüeñal G 37.69 x 3.53	GS	500434
46320530A	O'ring bancada cigüeñal G 158.42 x 2.62	GS 1	500435
46320529A	O'ring tapa inspección bomba inyectora G 63.22 x 1.78	GS 1	500437
46320186A	O'ring chupador aceite cárter G 26.57 x 3.53	GS 1	500438
46320188A	O'ring tubo llenado aceite G 31.34 x 3.53	GS 2	500439
	O'ring G 34.52 x 3.53	GS 1	
46320529A	O'ring carcasa intermedia G 63.17 x 2.62	GS	500440
	Salida de escape turbo	NFT 1	500540
46320234A	O'ring depresor G 66.4 x 1.78	GS 1	500441
	Salida de escape a turbo Ø 66 hasta 1987	AC	500543
22030389A	Acople bomba inyectora	NB 1	500246
	Salida de escape a turbo Ø 63 1987/....	AC	500546
22020138A	Jgo. suplemento camisa cilindro (0.15)	CU	500470-0.15
22020153A	Jgo. suplemento camisa cilindro (0.20) (4)	CU 1	500470-0.20
22020165A	Jgo. suplemento camisa cilindro (0.23)	CU	500470-0.23
46320531A	Jgo. o'ring camisa cilindro G 94.92 x 2.62 (3)	GS 4	500473
	Kit de retenes completo		R500400
	Retén bancada 90 x 120 x 12	P	R500411P
	Retén distribución 56 x 80 x 10	P	R500412P

VM / BORGWARD

VM



Motor/Engine	Cm³	HP	Ø
VM425TD	2499	114/121	92
VM41B	2499	115	92
SCC/SCD	2499	115/125	92

Chrysler: Dakota TD - Grand Voyager TD 1995/...
Ford: Scorpio TDI SCC/SCD 1994/98
Jeep: Cherokee - Grand Cherokee TD 1997/...
Opel: Frontera A TD 1995/98
Rover: 825 TD 1996/99



DIESEL

Nº OE	Descripción/Description	Mat.	Ref.
1.203.2114FI	Jgo. de juntas para motor		520301-R
22022080	Junta tapa cilindros Ø 98 ± 1.40	NFT	520307-SM
22022082	Junta tapa cilindros Ø 98 ± 1.50	NFT	520307-1M
22022081	Junta tapa cilindros Ø 98 ± 1.60	NFT	520307-2M
4863781	Junta tapa cilindros Ø 98 ± 1.42	MLS	520308-SM
4863782	Junta tapa cilindros Ø 98 ± 1.52	MLS	520308-1M
4863783	Junta tapa cilindros Ø 98 ± 1.62	MLS	520308-2M
21762062/69/70	Jgo. tornillos tapa cilindros (HAS14038)		B520300
04863789AB	Conj. junta tapa válvulas (inyector inclinado) (5)	NB	520310
	Junta para cárter	NB	520311
	Frente motor	NB	520312
	Junta para cárter inferior	NH	520331
05003546AA	Jgo. múltiple escape (4) 52315-1	AC	520315
	Múltiple admisión y escape 1998/...	MLS	520315-2
05003546AA	Jgo. múltiple admisión (4) 50417-1	NB	500417
04720451	Base bomba de agua	NB	520319
04720196	Comando bomba inyectora	NB	400246
04720450	Cañería de agua	NB	500429
04778965	E.G.R (recirculación de gases escape)	NB	520330
04778971	Base termostato	NB	520332
	Base delantera a distr. a eje dirección hidráulica	NB	520333
04796007AB	Descarga turbo	NB	520334
04720203	Escape turbo	AC	520335
	Conj. junta tapa válvulas (inyector recto) (5)	NB	520336
	Termostato	GS	460237
05015027AA	Junta	AC	520337
05015028AA	Junta escape turbo	AC	270345
	Jgo. juntas turbo (4)	VS	520368
	Jgo. suplemento camisa cilindros (0.15) (4)	CU	500470-015
	Jgo. suplemento camisa cilindros (0.20) (4)	CU	500470-020
	Jgo. suplemento camisa cilindros (0.23) (4)	CU	500470-023
	O`ring camisa cilindros G 94.92 x 2.62 S	S	500473/1S
	O`ring camisa cilindros G 94.92 x 2.62 N	N	500473/1N
	O`ring G 63.22 x 1.78	GS	2
	O`ring G 63 x 3	GS	1
	O`ring G 158.42 x 2.62 (cigüeñal)	GS	1
	O`ring G 88.57 x 2.62	GS	1
	O`ring G 21.82 x 3.53	GS	1
	O`ring G 17.12 x 2.62	GS	2
	O`ring G 5.28 x 1.78	GS	1
	O`ring G 94.97 x 1.78	GS	4
	Arandela tapa válvulas A 8 x 14 x 1.5 C	CU	4
	Arandela A 8 x 12 x 1 C	CU	12
	Arandela A 10 x 14 x 1 C	CU	5
	Arandela A 12 x 16 x 1.5 C	CU	9
	Arandela A 14 x 18 x 1.5 C	CU	5
	Kit de retenes completo		R520300
	Jgo. retén válvulas (8)	P	R520310P
0470283	Retén bancada 110 x 130 x 13	P	R310411P
05010856AA	Retén distribución 52 x 68 x 9.5	V	R520312V

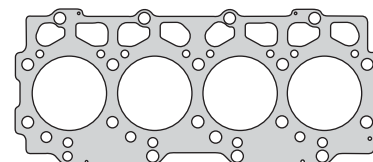

520308

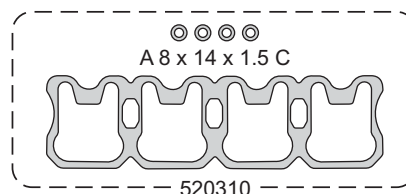

520310

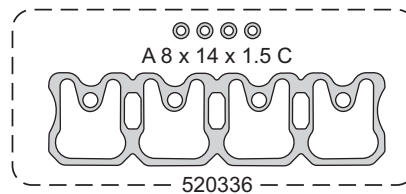

520336

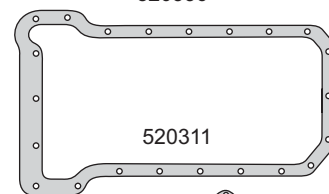

520311

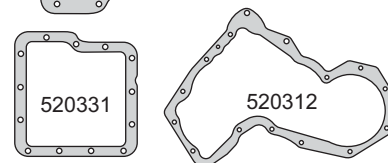

520331

520312

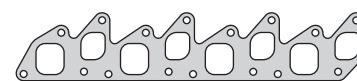

520315-2

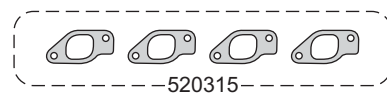

520315

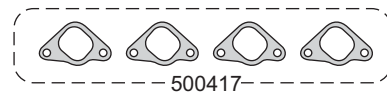

500417



520319

500429

520330

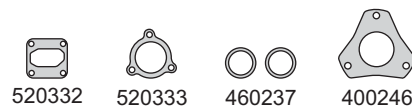

520332

520333

460237

400246

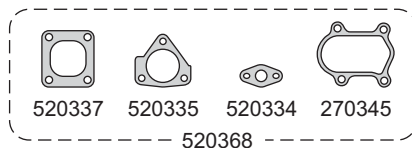

520337

520335

520334

270345

520368

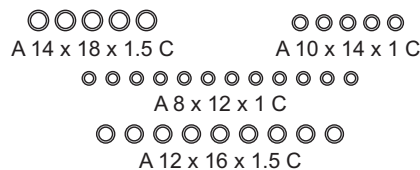

A 14 x 18 x 1.5 C

A 10 x 14 x 1 C

A 8 x 12 x 1 C

A 12 x 16 x 1.5 C



R310411P



R520312V



R520310P

VM / BORWARD

VM



Motor/Engine	Cm³	HP	Ø
VM 531 TD	3100	142	92

Chrysler: Jeep Cherokee - Grand Cherokee
Dakota - Caravan 2001/...

DIESEL



Nº OE	Descripción/Description	Mat.	Ref.
05015077AA	Jgo. de juntas para motor		520401-R
	Junta tapa cilindros Ø 98 ± 1.40	NFT	520407-SM
	Junta tapa cilindros Ø 98 ± 1.50	NFT	520407-1M
	Junta tapa cilindros Ø 98 ± 1.60	NFT	520407-2M
60507777	Junta tapa cilindros Ø 98 ± 1.42	MLS	520408-SM
60507769	Junta tapa cilindros Ø 98 ± 1.52	MLS	520408-1M
60507768	Junta tapa cilindros Ø 98 ± 1.62	MLS	520408-2M
21762070/69/62	Jgo. tornillos tapa cilin. (HAN12055/HAN12100)		B520400
04863789AB	Conj. junta tapa válvulas (6)	NB	1 520410
	Junta para cárter	NB	1 520411
	Frete motor	NB	1 520312
05003546AA	Jgo. múltiple escape (5) 520315/1	AC	1 520415
05003546AA	Jgo. múltiple admisión (5) 500417/1	NB	1 520417
04720451	Base bomba de agua	NB	1 520319
04720196	Comando bomba inyectora	NB	400246
04720450	Cañería de agua	NB	5 500429
04778965	E.G.R (recirculación de gases escape)	NB	1 520330
	Junta sobre cárter	NB	1 520431
	Junta sobre cárter inferior	NH	1 520331
04778971	Base termostato	NB	1 520332
	Base delantera a distribución a eje dirección hidráulica	NB	1 520333
04796007AB	Descarga turbo	NB	1 520334
04720203	Escape turbo	AC	1 520335
	Termostato	GS	2 460237
05015027AA	Junta	AC	520337
05015028AA	Junta	AC	270345
	Jgo. juntas turbo (4)	VS	520368
	Jgo. suplemento camisa cilindros (0.15) (5)		500470-0.15
	Jgo. suplemento camisa cilindros (0.20) (5)		500470-0.20
	Jgo. suplemento camisa cilindros (0.23) (5)		500470-0.23
	O`ring camisa cilindros G 94.92 x 2.62 S	N	10 500473/1N
	O`ring camisa cilindros G 94.92 x 2.62 N	S	5 500473/1S
	O`ring G 63.22 x 1.78	GS	2
	O`ring G 158.42 x 2.62 (cigüeñal)	GS	1
	O`ring G 88.57 x 2.62	GS	1
	O`ring G 21.82 x 3.53	GS	1
	O`ring G 18.72 x 2.62	GS	1
	O`ring G 17.12 x 2.62	GS	2
	O`ring G 5.28 x 1.78	GS	1
	Arandela tapa válvulas A 8 x 14 x 1.5 C	CU	5
	Arandela A 8 x 12 x 1 C	CU	14
	Arandela A 10 x 14 x 1 C	CU	6
	Arandela A 12 x 16 x 1.5 C	CU	10
	Arandela A 14 x 18 x 1.5 C	CU	6
	Arandela A 16 x 20 x 1.5 C	CU	1
	Arandela A 17 x 22 x 1.5 C	CU	1
	Arandela A 20 x 26 x 1.5 C	CU	3
	O`ring G 94.92 x 2.62	GS	1
	O`ring G 94.97 x 1.78	S	5
	Kit de retenes completo		R520400
	Jgo. retén válvulas (10)	P	1 R520410P
04720283	Retén bancada 110 x 130 x 13	P	1 R310411P
05010856AA	Retén distribución 52 x 68 x 9.5	V	1 R520312V

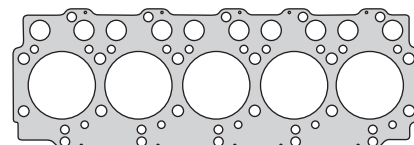

520408

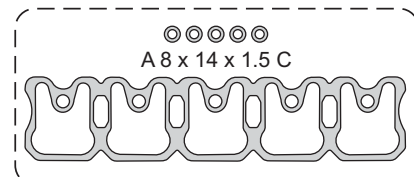

A 8 x 14 x 1.5 C

520410

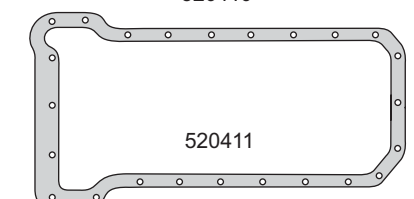

520411



520415

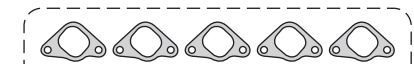

520417

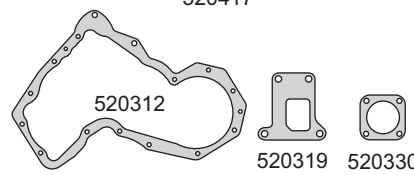

520312

520319 520330

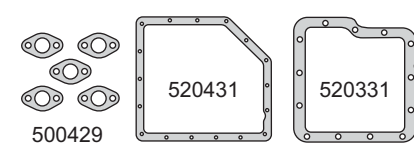

520431

520331

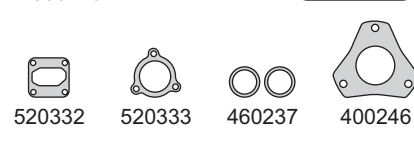

500429 520332 520333 460237 400246

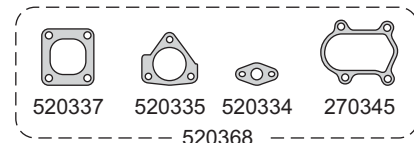

520337 520335 520334 270345

520368



G 158.42 x 2.62

G 63.22 x 1.78

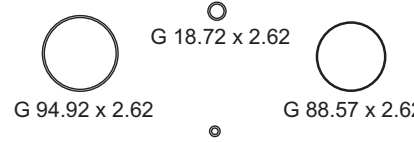

G 94.92 x 2.62

G 88.57 x 2.62

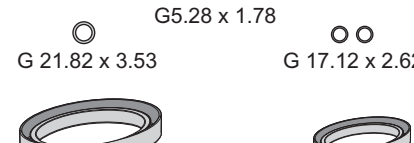

G 21.82 x 3.53

G 17.12 x 2.62



R310411P

R520312V

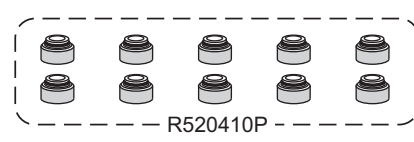

R520410P

VM / BORGWARD



taranto



Sistemas de Embrague Taranto Premium

Diseñado para resistir las altas temperaturas generadas durante su funcionamiento, garantizando el óptimo desempeño en las más exigentes condiciones.

- Suavidad de acople en arranques y cambios de velocidades
- Transmisión de fuerza garantizada
- Óptima resistencia térmica
- Mayor confort y durabilidad
- Soporta altas exigencias
- Bajo esfuerzo operativo.

INCLUYE RODAMIENTOS

SKF





MOTORES NAFTA - DIESEL

220405 - 220407

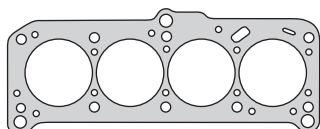

Código	Ø	≠	Kit Bulón
220405	81.0	1.70	B220400
220407	81.0	1.70	(HAN12055) (HAN12100)

Modelo	Passat - Dasher (USA) 1975/84 - Caddy - Golf - Gacel 1975/84 Rabbit - Santana 1979/83 - Caribe - Jetta 1981/84 Scirocco 1981/83 - Quantum 1982/83 - Atlantic 1977/84
Motor	1457cc. EH/GH/JB/FT/FV/YP 75/85/110HP Ø79.5 1588cc. FN/FP/FS/FT/FR/FV/WP/EM/WV/WY/YN/YS/YY 75/110HP Ø79.5 1714cc. EN 77/80HP Ø79.5 (220400-R) pág. 465

220605 - 220607

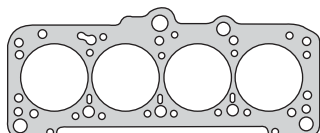

Código	Ø	≠	Kit Bulón
220605	82.2	1.70	B220400
220607	82.2	1.70	(HAN12055) (HAN12100)

Modelo	Gacel - Senda - Voyage - Gol - Santana - Passat - Apollo 1984/... Golf - Jetta - Combi Panel 1992/99
Motor	1595cc. AP 70HP Ø81 - 1781cc. AP 70HP Ø81 (220600-R) pág. 466 1800cc. L4 F.I 90HP Ø91 (231600-R) pág. 505

220805

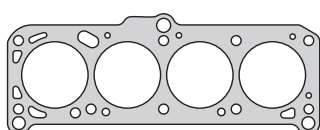

Código	Ø	≠	Kit Bulón
220805	79.0	1.70	B220400 (HAN12055) (HAN12100)

Modelo	Passat - Golf - Dasher (USA) - Scirocco - Rabbit - Brasil 1974/82
Motor	1457cc. ZC/YJ/FL/FB/FD/FH/FK 65/85HP Ø76.5 (220800) pág. 467

221007 - 221008

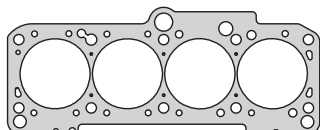

Código	Ø	≠	Kit Bulón
221007	83.5	1.60	B220400
221008	83.5	1.50	(HAN12055) (HAN12100)

Modelo	Golf - Passat 1992/96 - Polo 1999/... - Golf Cabrio 1999/02 Desde Motor 031252
Motor	1984cc. ATU/AWF/AWG/ABA/AGG 115HP Ø82.5 (221000-R) pág. 468

221107

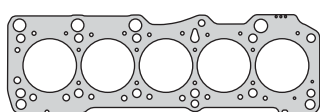

Código	Ø	≠	Kit Bulón
221107-1M	81.0	1.50	B221100
221107-2M	81.0	1.60	(HAN12055)
221107-3M	81.0	1.70	(HAN12100)

Modelo	Transporter T4 1992/99 - Transporter Syncro 1992/98 Eurovan - Caravelle 1997/...
Motor	2370cc. AAB - AJA 75/78HP Ø79.5 - DIESEL (221101-R) pág. 469

221507

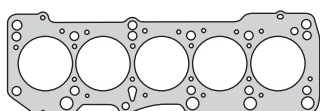

Código	Ø	≠	Kit Bulón
221507-1M	82.0	1.50	B221100
221507-2M	82.0	1.60	(HAN12055)
221507-3M	82.0	1.70	(HAN12100)

Modelo	Transporter T4 1998/... - Transporter Syncro TDI 1998/... Transporter T4 TDI 1995/99 - LT SDI 1996/...
Motor	2459cc. AJT - AGX - ACV 75/88/102HP Ø81 (221501-R) pág. 471 DIESEL

221707 - 221708

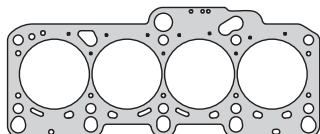

Código	Ø	≠	Kit Bulón
221707	82.0	1.50	B221700 B221800
221708	82.5	1.40	(HAN10168)

Modelo	New Beetle - Passat 1999/... - Golf - Sharan 1997/... - Bora Turbo 2000/... Passat 1996/99, 1999/... - Passat Turbo 1996/98
Motor	1781cc. AGU/ARZ/AJH/AVC/AWU/AWC/ARG/APT/AJP/AQA/AJQ/APP 125/150HP Ø81 (221700-R) pág. 473 1781cc. AEB/ANB 150HP - AFY/ADR 115HP Ø81 (221800-R) pág. 474

221907

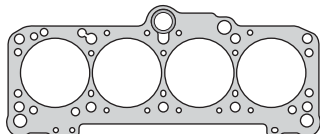

Código	Ø	≠	Kit Bulón
221907	83.5	1.70	B220400 B221900 (HAN12055) (HAN12100)

Modelo	Golf - Passat 1992/96 - Hasta Motor 031251 Golf GTI - Vento - Passat - Corrado 1991/94
Motor	1984cc. ABK/ABT/AE 101/115HP Ø82.5 (222595-R) pág. 479 (222695-R) pág. 480 1984cc. 2E 115HP Ø82.5 (223995-R) pág. 488 1985cc. ABF 150HP Ø82.5 (221900-R) pág. 475

222007

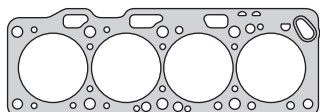

Código	Ø	≠	Kit Bulón
222007	76.0	1.60	B220400 (HAN12055) (HAN12100)

Modelo	Jetta 1985/91 - Polo 1985/92, 1990/94 - 1987/94 - Golf - Vento 1991/94 Seat Ibiza 1993/94 - 1993/99
Motor	1043cc. HZ - AAK - ACM - AAU 45/50HP Ø75 1272cc. UN - NU - 2G - AAV 55/60/75HP Ø75 1391cc. ABD 60HP Ø75 (222000-R) pág. 476

222108

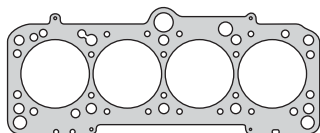









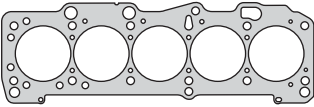





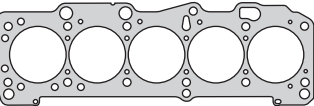





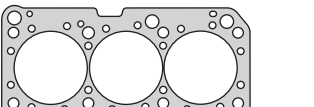





Código	Ø	≠	Kit Bulón
222108	83.5	1.65	B221900 (HAN12055) (HAN12100)











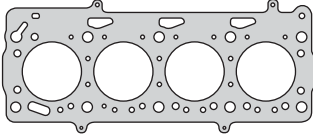
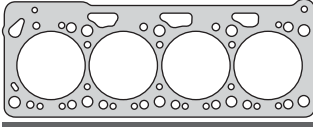
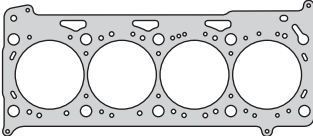



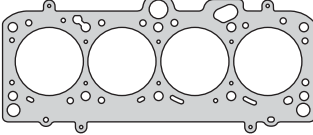
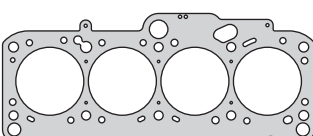

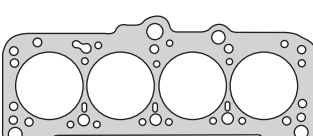

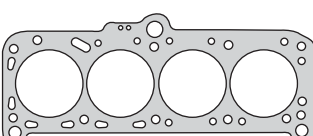
Modelo	Golf - Passat - Passat Variant 1992/97 Seat Cordoba - Ibiza - Toledo 1993/99
Motor	1985cc. ABF 16V 150HP Ø82.5 (222100-R) pág. 477

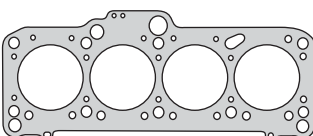

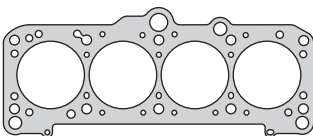
MOTORES NAFTA - DIESEL

	Código 222207	Ø 83.0	 1.70	Kit Bulón B222200 (HAN12055) (HAN12100)	Modelo Passat - Santana 1983/88 - Quantum 1985/88 Audi 80/80 Quattro, Coupe 90/100 - 100/200, Coupe, 90/90 Quattro 1983/91
	Motor 1994cc. JS/HP/SK/KP 113/115HP Ø81 2226cc. JS/HP/KV/HY 115/120/136HP Ø81 (222200-R)  pág. 478				
	Código 222307	Ø 77.0	 1.20	Kit Bulón	Modelo Seat Malaga 1985/93 - Ronda 1983/86
	Motor 1193cc. 021A1 - 021C1 62/71HP Ø75				
	Código 222407	Ø 85.0	 1.20	Kit Bulón	Modelo Fiat Palio 2001/... - Siena 2002/... Seat Malaga 1985/93 - Ronda 1984/..., Ibiza Sportline 1991/93
	Motor 1461cc. 178E5 - 021A2 85/90HP Ø83 1675cc. 021C3 98HP Ø83				
	Código 222707	Ø 84.0	 1.70	Kit Bulón B222200 (HAN12055) (HAN12100)	Modelo Audi 100 - 200 Avant - 100 Avant - Coupe - Cabriolet - 80 - 90 80 - 90 1985/94 - Cabrio - Coupe 1990/95 - A6 1994/... Coupe Quattro 1985/95 - 80 Quattro 1991/94 - 90 Quattro 1987/91
	Motor 2309cc. NF 100/136HP (222795-R)  pág. 481 2309cc. AAR/NG 133HP Ø82.5 (222895-R)  pág. 482				
	Código 222908	Ø 83.5	 	Kit Bulón	Modelo Passat - Golf - Vento 1994/97 - Sharan 1995/... Seat Toledo - Cordoba - Ibiza - Alhambra 1994/99
	Motor 1984cc. ADY - AGG - AEP 107/115HP Ø82.5				
	Código 223007	Ø 83.5	 1.80	Kit Bulón B223000 (HAN12055) (HAN12100)	Modelo Audi 80 1991/1994 - 80 Quattro - 100 Quattro 1992/94 - A6 Quattro 1994/... Coupe 1990/95 - A4 Quattro - A6 Quattro 1994/... - Cabriolet 1991/94
	Motor 2598cc. ACZ - ABC V6 144/150HP Ø82.5 2771cc. AAH - ABC - AEJ V6 163/174HP Ø82.5 (223000)  pág. 483				
	Código 223207-1M 223207-2M 223207-3M	Ø 78.0 78.0 78.0	 1.50 1.60 1.70	Kit Bulón B230100 (HAN12055) (HAN12100)	Modelo Caddy D - Jetta D/TD - Golf D/TD - Santana D/TD - Passat D/TD TYP 2/80 Transporter - D/TD 1985/93 - Audi 80D/TD - 90TD 1985/91
	Motor 1588cc. CS/JX/JP/CY/JK/RA/SB/CR/SV/1V/ME/JR 49/54/70/80HP Ø76.5 DIESEL				
	Código 223307	Ø 77.5	 1.60	Kit Bulón B230300 (HAN12055) (HAN12100)	Modelo Golf - Vento 1992/94 Seat Cordoba - Ibiza 1993/947
	Motor 1598cc. ABU 75HP Ø76.5 (223395-R)  pág. 484				
	Código 223407-1M 223407-2M 223407-3M 223408-1M 223408-2M 223408-3M	Ø 81.0 81.0 81.0 80.5 80.5 80.5	 1.50 1.60 1.70 1.55 1.63 1.71	Kit Bulón B223400 (HAN12055) (HAN12100)	Modelo Bora - Golf SDI/TDI 1997/...
	Motor 1896cc. ALH/AHF/AGR/AGP 68/90/110HP Ø79.5 (223401-R)  pág. 485 DIESEL				
	Código 223508-1M 223508-2M 223508-3M	Ø 80.5 80.5 80.5	 1.45 1.53 1.61	Kit Bulón B223500 (HAN12055) (HAN12100)	Modelo Passat TDI 1999/... - Sharan TDI 2000/... - Transporter TDI 2003/... Audi A4 TDI 2000/..., 2004/... - A6 TDI - Seat Alhambra TDI 2000/...
	Motor 1896cc. ATJ/AUY 115HP - AXC/AXB 85/105HP Ø79.5 (223501-R)  pág. 486 DIESEL				

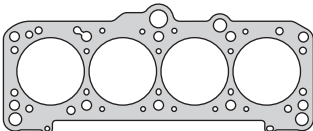
MOTORES NAFTA - DIESEL

	223608	Código	Ø	≡	Kit Bulón	Modelo	Polo 1996/... - Lupo 1998/... Seat Ibiza - Cordoba 1996/99
	223608		68.0	0.50		Motor	999cc. AER/ALL 50HP Ø67.1
	223708	Código	Ø	≡	Kit Bulón	Modelo	Polo 1994/... - Golf - Vento 1995/98 - Caddy 1997/... Seat Ibiza - Inca - Cordoba - Skoda Octavia - Felicia - Pick Up 1996/...
	223708		77.5	0.35	B230300 (HAN12055) (HAN12100)	Motor	1296cc. ADX 55HP Ø76.5 1391cc. AEX/APQ 55/60HP Ø76.5 1598cc. AEA/AEE 75HP Ø76.5
	224007 - 224008	Código	Ø	≡	Kit Bulón	Modelo	Fox - Suran 2005/... - Polo 2003/05 - Polo, Caddy 1997/01, Gol 2001/... Lupo 2004/09, Voyage, Gol Trend - Gol Power
	224007 224008		78.0 78.0	1.20 0.40	B224000 (HAN12055) (HAN12100)	Motor	1390cc. BKR/BLM (SOHC) 8V 75/86HP Ø76,5 (224000-R MLS)  pág. 489 1390cc. EA111 (SOHC) 8V 83HP Ø76,5 (232600-R MLS)  pág. 507 1598cc. BAH/BLH/BJA/BPA (SOHC) 100HP Ø76,5 (224000-R MLS)  pág. 489
	224107 - 224108	Código	Ø	≡	Kit Bulón	Modelo	Passat 1996/... - Golf 1997/... - Bora 1998/... - Polo 1999/... New Beetle - Bora - Golf 2000/... - Audi A3 2000/... Seat Toledo - Cordoba - Ibiza - Leon 1999/...
	224107 224108		82.5 82.5	1.20 1.10	B224100 (HAR10168)	Motor	1595cc. AEH/AKL/APF/AHL/ANA/ARM/AYD/AVU 100HP Ø81
	224308	Código	Ø	≡	Kit Bulón	Modelo	Derby - Bora - Passat - Golf - Polo 1999/... - Seat Ibiza 2001/03 Cordoba 2001/05
	224308		82.5	1.40	B224100 (HAR10168)	Motor	1595cc. APF/AKL/AEH 100HP Ø81 (224300-R)  pág. 491
	230005 - 230007	Código	Ø	≡	Kit Bulón	Modelo	Carat - Quantum - Pointer - Gol - Golf - Santana 1989/...
	230005 230007		83.5 83.5	1.70 1.70	B220400 (HAN12055) (HAN12100)	Motor	1984cc. Audi 827 107/115HP Ø82.5 (230000-R)  pág. 492 1984cc. AP 8V 107/115HP Ø82.5 (233000-R)  pág. 508
	230107	Código	Ø	≡	Kit Bulón	Modelo	Senda - Saveiro - Caddy - Golf D/TD - Passat - Kombi - Santana - 1981/86 Audi 80 D/TD 1981/85
	230107-1M 230107-2M 230107-3M 230107-4M		78.0 78.0 78.0 78.0	1.40 1.50 1.60 1.70	B230100 (HAN12055) (HAN12100)	Motor	1588cc. CR/JK/JP/JR/JF/JX/CS/CY 49/54/70HP Ø76.5 - DIESEL (230101-R)  pág. 493
	230207 - 230208	Código	Ø	≡	Kit Bulón	Modelo	Passat TD 1994/96 - Golf D/TD - Vento D/TD - Polo D - Caddy 1995/... Seat Ibiza D/TD - Cordoba 1996/99 - Toledo 1997/99
	230207-1M 230207-2M 230207-3M 230208-1M 230208-2M 230208-3M		80.5 80.5 80.5 81.0 81.0 81.0	1.50 1.60 1.70 1.53 1.57 1.61	B230100 (HAN12055) (HAN12100)	Motor	1896cc. 1Y - AAZ - AEU 64/75HP Ø79.5 - DIESEL (230201-R)  pág. 494
	230307 - 230308	Código	Ø	≡	Kit Bulón	Modelo	Golf - Jetta - Passat - Santana - Caddy 1982/93 - Scirocco 1970/92 Quantum 1984/85 - Golf Cabriolet 1985/93 - Fox 1987/93 - Vento 1991/93 Polo Classic 1995/... - Vento 1992/97 - Passat 1991/96
	230307 230308		82.2 82.5	1.70 1.60	B230300 B220400 (HAN12055) (HAN12100)	Motor	1595cc. RF/1F/FN/DT/ABN/EW/RE 70/75HP Ø81 (221400-R)  pág. 470 1781cc. DS/DZ/RF/RF/ABS/GU 75/95/112HP Ø81 (221400-R)  pág. 470 1781cc. AAM/ABS/ADZ 75/90HP Ø81 (221695-R)  pág. 472
	230307 - 230308	Código	Ø	≡	Kit Bulón	Modelo	Golf 1991/99, Vento 1992/97, Polo Classic, Passat 1991/96, Jetta 1994/96 Golf 1989/91, Scirocco 1985/92, Jetta 1986/87, Passat, Corrado 1990/92
	230307 230308		82.2 82.5	1.70 1.60	B230300 B220400 (HAN12055) (HAN12100)	Motor	1781cc. KR 130HP Ø81 (223895-R)  pág. 487 1781cc. AAM/ABS/ADZ/ADD 75/90HP Ø81 (230300-R)  pág. 495



MOTORES NAFTA - DIESEL

230507 - 230508

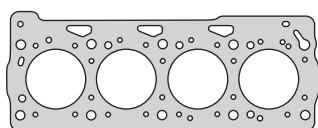

Código	Ø	≠	Kit Bulón
230507	70.0	1.20	B230500 B230600
230508	68.0	0.40	(HAN12055) (HAN12100)

Modelo	Motor
Gol 1000 - Saveiro 1998/... - Polo 1995/... Gol 1000 - Saveiro - Polo 1995/... - Seat Ibiza - Cordoba 1996/...	999cc. AT (DOHC) 16V 69HP Ø67.08 (230500-R) pág. 496 999cc. AER/ALL (SOHC) 8V 50HP Ø67.1 (230600-R) pág. 497

230507 - 230508

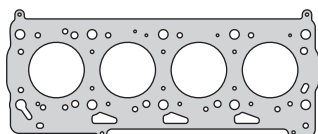

Código	Ø	≠	Kit Bulón
230507	70.0	1.20	B230500 B230600
230508	68.0	0.40	(HAN12055) (HAN12100)

Modelo	Motor
Fox 2003/... - Gol - Power 2002/...	999cc. AQZ - BJE 8V 71/72HP Ø67.1 (224200 MLS) pág. 490 999cc. AT (SOHC) 8V 50/69HP Ø67.1 (231200-R MLS) pág. 501 999cc. AT (DOHC) 16V Ø67.08 (231300-R MLS) pág. 502

230707

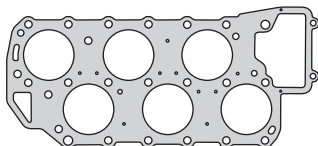

Código	Ø	≠	Kit Bulón
230707	83.0	1.60	B230700 (HAN12055) (HAN12100)

Modelo	Motor
Passat VR6 - Golf VR6 1991/97 - Vento VR6 1992/97 - Jetta 1993/...	2792cc. AAA 174HP Ø81 2862cc. ABV V6 190HP Ø82 (230700-R) pág. 498

230907 - 230908

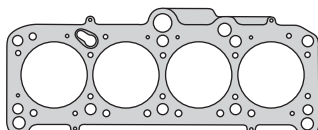

Código	Ø	≠	Kit Bulón
230907-1M	81.0	1.45	B230100 (HAN12055) (HAN12100)
230907-2M	81.0	1.53	
230907-3M	81.0	1.61	
230908-1M	81.0	1.45	
230908-2M	81.0	1.53	
230908-3M	81.0	1.61	

Modelo	Motor
Golf SDI/TDI 1993/95-1999/... - Vento SDI/TDI 1993/95 - Caddy SDI 1995/... Passat TDI 1993/95-1995/... - Polo TDI/SDI - Sharan TDI 1995/96 A4 D/TDI 1994/96, 1997/00 - A6 TDI - CabrioTDI 1994/96 - 80TDI 1991/94	1896cc. AHU/AVG/AEY/1Z/AFN/AHH/1Z/AFF/AHH 64/90/110HP Ø79.5 DIESEL (230901-R) pág. 499

231108

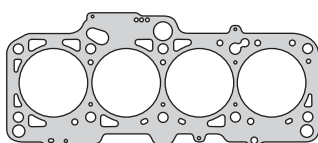

Código	Ø	≠	Kit Bulón
231108	83.5	1.20	B224100 (HAR10168)

Modelo	Motor
Golf - New Beetle 2002/... - Transporter Minibus 2003/... - Touran Caddy 2006/... - Polo BR 2002/...	1984cc. BEH/BER/AZG/AXA /AEG 115HP - BSX 109HP Ø82.5 1985cc. BBX 116HP Ø82.5 (231100-R MLS) pág. 500

231408

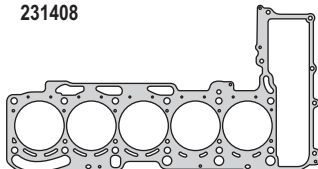

Código	Ø	≠	Kit Bulón
231408	83.0	0.60	

Modelo	Motor
Bora - Vento 2005/09	2480cc. L5 BGP/BGQ 148/168HP Ø83 (231400-R MLS) pág. 503

231507

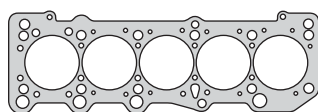

Código	Ø	≠	Kit Bulón
231507	83.0	1.60	B221100 (HAN12055) (HAN12100)

Modelo	Motor
Eurovan 2001/04	2461cc. AET/APL/AVT/L5 115HP Ø83 (231500-R) pág. 504

232408

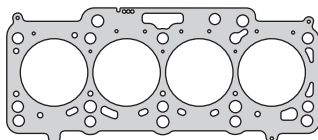

Código	Ø	≠	Kit Bulón
232408-1M	82.0	1.55	B232400
232408-2M	82.0	1.63	
232408-3M	82.0	1.71	

Modelo	Motor
Pick Up Amarok TDI 2010/... Inyección directa Common Rail	1968cc. CDBA/CDCA 90/120HP Ø81 - DIESEL (232401-R) pág. 506

232508

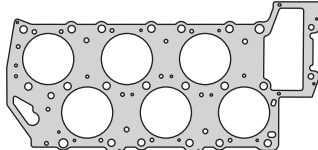

Código	Ø	≠	Kit Bulón
232508	85.20	0.60	

Modelo	Motor
Touareg 2003/06 - Golf 2005/... - Eos 2006/... - New Beetle RSI 2000/01 Golf 2002/04, Touareg 2003/06, Phaeton 2003/07, Transporter 2004/... Audi A3 2005/... - TT 2006/...	3189cc. BAA/BMX/BRJ/AXJ/ADZ/BKJ/BMV 220/225HP BUB/CBRA 250HP BFH/BKL/BRK 241HP - BDL/BKK 231/235HP VR6 (DOHC) 24V Ø84

232708

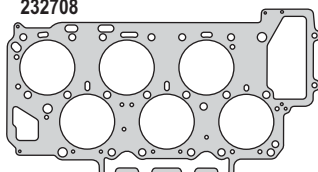









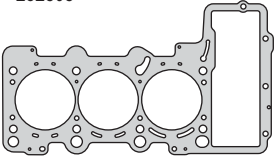
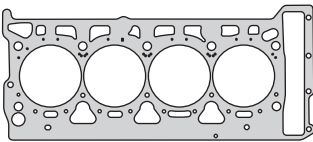
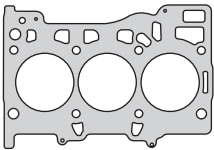

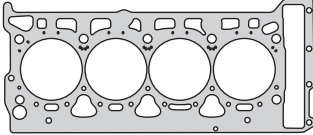

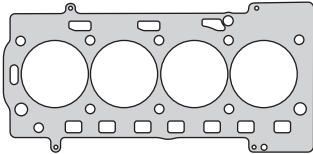

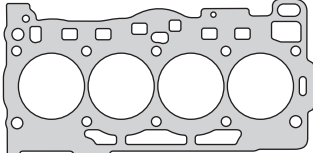

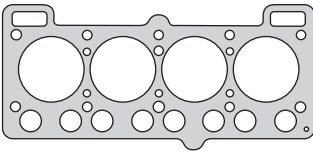
Código	Ø	≠	Kit Bulón
232708	89.5	0.90	

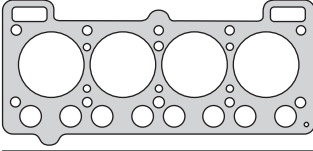
Modelo	Motor
Passat FSI - Eos - Phaeton - Touareg FSI 2005/... Audi Q7 2006/...	3168cc. AXZ V6 (DOHC) 24V 250HP Ø86 3597cc. BHK/BHL/BLV VR6 V6 (DOHC) 24V 280HP Ø89

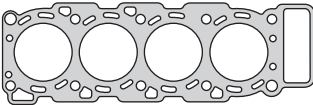

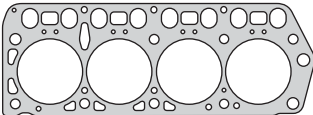
MOTORES NAFTA - DIESEL

	232808	Código	Ø	≠	Kit Bulón	Modelo	Touareg - Touareg TSI 2010/... Audi A4/A6/A8 FSI 2005/... - A4 - A6 Quattro 2006/... - Q7/Q5 Quattro A8 Quattro 2010/... - A5 Cabriolet/Coupe 2011/... - A4/A8/A6 Quattro 2012/...
	232808		85.5	1.53		Motor	2773cc. BDX/CCDA/CEEA V6 (DOHC) 24V 190/209/220HP Ø84.5 2995cc. CJTC/CJTB/CMDA/CNAA/CTTA/CTWA/CTWB/CTUC/CTVA Ø84.5 2995cc. CJTA/CGFA/CGEA V6 (DOHC) 24V 290/333HP Ø84.5 3123cc. BKH/AUK/BPK/BKH/BYU V6 (DOHC) 24V 255HP Ø84.5
	232908	Código	Ø	≠	Kit Bulón	Modelo	Audi TT TFSI 2006/... A3/A4/A5 2008/... Q5/A4 2009/... Seat Leon - Toledo TSI - Skoda Octavia TSI 2007/... Passat TSI - Golf - Eos - Tiguan - Passat - Scirocco - Jetta FSI 2007/...
	232908		83.3	0.90		Motor	1798cc. BZB/CDA/CDAB 160/152HP (DOHC) 16V Ø82.5 1984cc. CBFA/CCTA/CCZA/CBFA/CAWB/CCTB/CAWA/CAWB/CCZB 170/200/210HP Ø82.5
	233108	Código	Ø	≠	Kit Bulón	Modelo	UP 2011/... - Skoda Citigo 2011/... - Seat Mii 2011/...
	233108		75.5	0.30		Motor	1598cc. CHYA/CHYB (DOHC) 16V 60/75HP Ø74.5 (233100-R MLS)  pág. 509
	233208	Código	Ø	≠	Kit Bulón	Modelo	Passat TSI 2007/... - Golf FSI - Tiguan FSI - Eos FSI - Passat FSI 2007/... Scirocco FSI 2008/... - Seat Altea TSI - Leon TSI - Toledo TSI 2009/10 Audi A3/A4/A5/Q5 TFSI 2008/... - A4/A5 Quattro 2010/...
	233208		83.0	0.90		Motor	1798cc. CDA/CDAB (DOHC) 16V 152/160HP Ø82.5 1984cc. CBFA/CCTA/CCZA/CCTB/CAWB/CDNB/CDNC/CAEB/CAEA (DOHC) 16V 170/200/211HP Ø82.5 (233200-R MLS)  pág. 510
	233308	Código	Ø	≠	Kit Bulón	Modelo	Golf FSI - Touran FSI - Passat FSI - Jetta FSI 2005/... - Eos FSI - Polo Crosspolo 2006/... - Skoda Octavia 2004/... - Audi A3 FSI 2003/...
	233308		77.5			Motor	1798cc. BAG/BLP/BLF/BTS (DOHC) 16V 105/115HP Ø76.5 (233300-R MLS)  pág. 511
	233408	Código	Ø	≠	Kit Bulón	Modelo	Suran - Suran Cross - Saveiro - Novo Fox - Gol Rallye - Saveiro Cross 2015/...
	233408		77.0	0.40		Motor	1598cc. EA211 (DOHC) 16V110HP Ø76.5 (233300-R MLS)  pág. 512
	300705 - 300707	Código	Ø	≠	Kit Bulón	Modelo	Saveiro, Voyage, Logus 1989/...
	300705 300707		78.0 78.0	1.40 1.40	B300700 (HAS17038)	Motor	1555cc. CHT/AE 73HP Ø77 (300700-R)  pág. 210
	310705	Código	Ø	≠	Kit Bulón	Modelo	Gol 1.0 1993/...
	310705		73.0	1.40	B300700 (HAS17038)	Motor	997cc. CHT/AE Ø70.3 (310700-R)  pág. 241
	330507	Código	Ø	≠	Kit Bulón	Modelo	LTDI 1997/... - Electronico 2002/06
	330507 330507-1.70 330508		96.0 96.0 96.0	1.40 1.70 1.40	B330500 (HAS17038)	Motor	2796cc. AGK/ATA/BCQ 125/132/158HP Ø93 (330500-R)  pág. 319 2796cc. BCQ 158HP Ø93 (331100-R)  pág. 321
	923507	Código	Ø	≠	Kit Bulón	Modelo	Taro 1989/94
	923507		93.5	1.76		Motor	2366cc. 4Y 94HP Ø91 (923500-R) 

VOLKSWAGEN



Motor/Engine Cm³ HP Ø

Air Cooler 1285 39/43 77

Volkswagen: Kombi - Escarabajo - Fusca 1969/...



Nº OE	Descripción/Description	Mat.	Ref.
1111980072	Jgo. de juntas para motor		220300-R
113101841F	Junta tapa válvulas	CG 2	220310
111251261	Jgo. múltiple escape (4)	CHA 1	220315
311129707	Unión admisión B 32 x 38 x 2.4 CN	CN 2	220317
04019856910	Jgo. juntas carburador	VS	220320
N-13778-1	Base carburador	CB 1	220325
	Junta	CB 1	220325-1
111115111A	Cuerpo bomba aceite	CB 2	220327
	Tapa filtro aceite	CB 1	220327-1
113127313	Base bomba nafta	CB 1	220328
111115131B	Tapa filtro aceite	CB 1	220329-1
113101219	Respiradero motor	CB 2	220330
	Junta	CB 1	220330-1
113127311	Base bomba nafta inferior	CB 1	220331
029/15189/1	Bomba AC block	CHA 2	220431
	Junta base carburador	CB 4	150232
112115189	Cuerpo bomba aceite	NH 2	220332
113109345A	Tubo balancines	GS 16	220333
N-13815-2	Anillo B 14 x 18 x 2 CN	CN 1	150034
311117151A	Tubo radiador aceite	GS	220334
N-13817-1	Anillo B 16 x 22 x 2.4 CN	CN 1	150035
311129707B	Tubo admisión	CB 2	220335
113101125	O'ring G 10 x 4	GS 6	220336
0401171513	Apoyo radiador aceite NAC	GS	220337
N-13830-1	Anillo G 7.59 x 2.62	GS 4	220338
N-13804-2	Anillo A 6 x 10 x 1 C	CU 6	220340
113251236	tubo precalentador	NH	220341
	Tubo radiador AC	AC	220342
	Polea		220343
	Volante motor		220344
	Ventilador dinamo	AC 1	220345
0409052461	Anillo asiento distribuidor		220347
111115131B	Tapa bomba de aceite		220348
040/129795/3	Separador carburador		220349
	Jgo. juntas caja velocidades	NH	220350
	Junta	CB 1	220371
	Junta	CB 1	220372
	Arandela A 7 x 17 x 1 F	F	
	Guarnición G 9 x 21 x 6	GS 5	
	O'ring G 21.82 x 3.53	GS 1	
	Anillo G 12.5 x 7 x 3	GS 7	
	Radiador aceite G 9 x 14 x 10	GS 4	
	O'ring volante G 54 x 3	GS 1	
	Jgo. juntas suplemento camisa (0.02) (4)	CB 1	220370-0.02
	Retén bancada 70 x 90 x 10	P 1	R220311P



220310

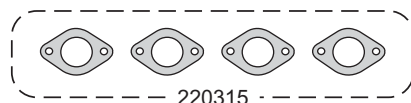

220315

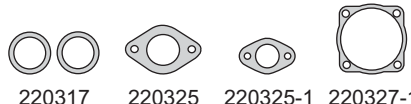

220317 220325 220325-1 220327-1

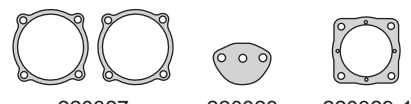

220327 220328 220329-1

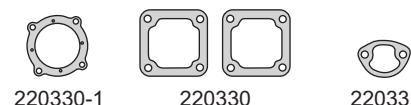

220330-1 220330 220331

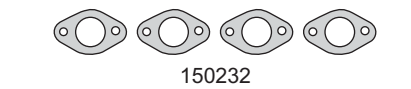

150232

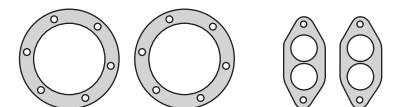

220332 220335



220333

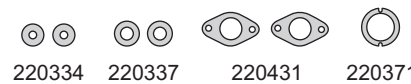

220334 220337 220431 220371



220372 G 9 x 21 x 6 220345



G 21.82 x 3.53



B 14 x 18 x 2 CN B 16 x 22 x 2.4 CN



G 10 x 4



G 7.59 x 2.62 A 6 x 10 x 1 C



G 54 x 3



G 9 x 14 x 10 G 12.5 x 7x 3



220370-0.02



R220311P

VOLKSWAGEN/AUDI

VOLKSWAGEN



Motor/Engine	Cm³	HP	Ø
EH/GH/JB/FT/V/Y/P	1457	70/85/110	79.5
YH/Y/P/Y/T/Y/K/Y/W	1588	75/85/110	79.5
YS/Y/Z/Y/N/V/Y/V/Z	1588	75/85/110	79.5
FN/FP/FS/FT/FR/FV	1588	75/110	79.5
WP/EM/WV/WY/Y/N	1588	75/110	79.5
EN/WT	1714	77/80	79.5

Audi: 4000 - 80 - 4E - 100 - Fox 1979/83
Coupe 1980/81 - 4000 - 1981/83

Volkswagen: Caddy - Passat - Dasher (USA)
Jetta - Scirocco - Golf - Santana
Gacel - Caribe - Atlantic
1975/84

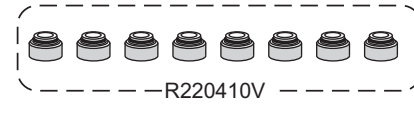
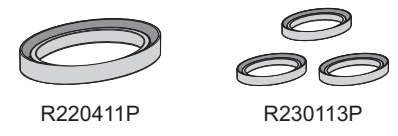
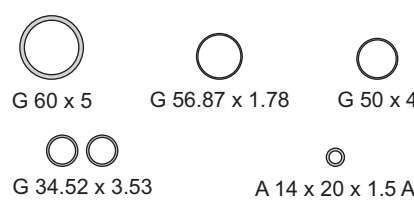
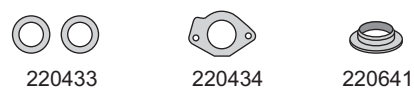
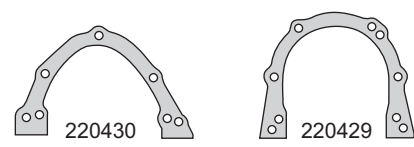
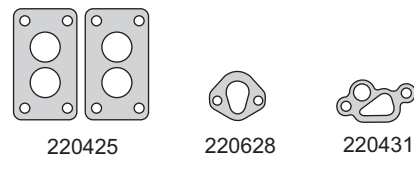
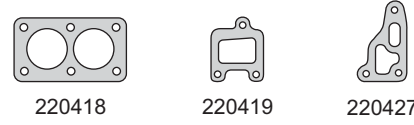
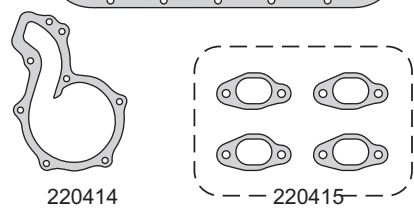
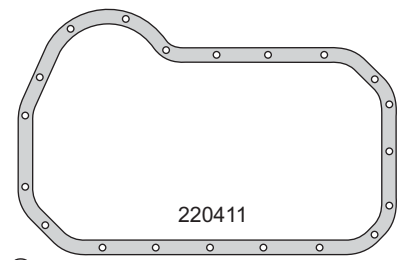
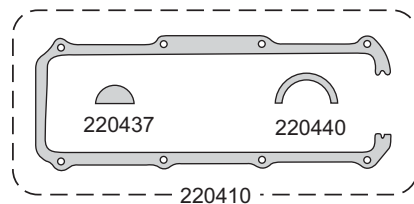
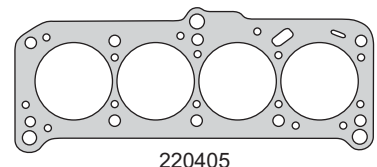

Nº OE	Descripción/Description	Mat.	1	2	Ref.
	Jgo. de juntas para motor				220400-R
	Jgo. de juntas superior				220495
049103383A	Jta. tapa cilindros Ø 81 ± 1.70	NFT	1	1	220405
049103383A	Jta. tapa cilindros Ø 81 ± 1.70	NFT			220407
	Jgo. de tornillos JTC (HÁN12055/HÁN12100)				B220400
056103483C	Conj. juntas tapa válvulas (3)	CG	1	1	220410
056103609A	Junta para cárter	CG		1	220411
056121041A	Bomba de agua	NB		1	220414
056129589A	Jgo. múltiple escape (4)	FCH	1	1	220415
056129717	Múltiple admisión	NB	1	1	220417
841253115B	Salida de escape	NFT	1	1	220418
056121139A	Entrada agua	NB	1	1	220419
	Jgo. juntas carburador WEBER	VS			220420
059129799D	Base carburador	NB	2	2	220425
056115441	Base filtro aceite	NB		1	220427
	Junta base bomba nafta	NB		1	220628
056103181	Bancada trasera	NB		1	220429
056103161	Bancada delantera	NB		1	220430
029/15189/1	Bomba AC block	NB		1	220431
0261297971	Base intermedia admisión				220432
056905261	Base distribuidor	CB		2	220433
026121149	Termostato	NB	1	1	220434
N/901814/01	O'ring base radiador aceite G 60 x 5	GS		1	220436
056103491	Media luna tapa cilindros	GS	1	1	220437
026/121/149	O'ring termostato G 50 x 4	GS		1	220438
059/127311/A	O'ring bomba nafta G 34.59 x 2.62	GS			220439
056103489A	Cuello tapa válvulas superior	S	1	1	220440
	Guarnición conducto admisión	N		1	220641
	O'ring porta retén distribución G 56.87 x 1.78	GS		1	220442
	Jgo. juntas caja velocidades 5ta.	CB			220450
	Jgo. juntas caja velocidades 4ta. 1ra. serie	VS			220451
	Jgo. juntas caja velocidades 4ta. 2da. serie	VS			220452
056103609A	Junta para cárter	CGT			220460
056103483C	Junta tapa válvulas	CGT			220461
	O'ring G 34.52 x 3.53	GS	2	2	
029/103608/1	Arandela tapón cárter A 14 x 20 x 1.5 A	AL		1	
	Kit de retenes completo				R220400
026/109675	Jgo. retén válvulas (8)	V		1	R220410V
	Retén bancada 85 x 105 x 12	P		1	R220411P
026/103085/E	Retén distrib. y árbol levas 32 x 47 x 10	P		3	R230113P

VOLKSWAGEN / AUDI

VW-FORD



Motor/Engine	Cm³	HP	Ø
AP	1595	70	81
AP	1781	85/87	81

Ford: Del Rey - Belina 1989/91
 Escort - Scala - Pampa 1989/...
 Verona - Royale - Versailles 1990/96

Volkswagen: Gacel - Senda - Voyage - Gol
 Santana - Passat - Logus
 Apollo 1984/...



Nº OE	Descripción/Description	Mat.	Ref.
	Jgo. de juntas para motor		220600-R
	Jgo. de juntas para motor	●	220600
	Jgo. de juntas superior		220695
	Jgo. de juntas superior		220697
026103383	Jta. tapa cilindros Ø 82.2 ± 1.70	NFT 1 1	220605
026103383	Jta. tapa cilindros Ø 82.2 ± 1.70	NFT	220607
	Jgo. tornillos tapa cil. (HAN12055/HAN12100)		B220400
056103483D	Conjunto tapa válvulas superior (3)	CG 1 1	220410
0491036091	Junta para cárter	NFT	220611
049121041B	Bomba de agua	NB	220614
056129589	Jgo. múltiple escape (4)	FCH 1 1	220415
	Múltiple admisión	NB 1 1	220417
02129717	Múltiple admisión	NB 1 1	220617
841253115B	Salida de escape	FCH 1 1	220418
	Salida de escape Gol GLZ	CHA	220618
056121139A	Entrada agua	NB 1 1	220419
	Jgo. juntas carburador SOLEX 2E7	VS	220620
026/198569	Jgo. juntas carburador BROSOL	VS	220621
	Jgo. jtas. inyección electrónica (Fic-Visteon-Eec IV)	VS	220424
	Jgo. jtas. inyección electrónica (Magnetti Marelli)	VS	220624
	Base carburador SOLEX 2 EJ	NB 2 2	220625
	Base carburador	NB	230025
056115441	Base filtro de aceite	NB	220427
059127311A	Base bomba nafta	NB	220628
056103181	Bancada trasera	NB	220429
	Base carburador BROSOL	NB 1 1	220629
056103161	Bancada delantera	NB	220430
029/115189/1	Bomba de aceite a block	NB	220431
	Base intermedia admisión		220432
056905261	Base distribuidor	CB	220433
056121149	Termostato	NB 1 1	220434
N/901814/01	O'ring base radiador aceite G 60 x 5	GS	220436
056103491	Media luna tapa cilindros	GS 1 1	220437
059/121119/	Termostato o'ring G 50 x 4	GS	220438
059/127311/A	O'ring bomba nafta G 34,59 x 2,62	GS	220439
056103489A	Cuello tapa válvulas superior	S 1 1	220440
	Unión caño de escape	H	220640
	Guarnición conducto admisión	N 1 1	220641
	O'ring porta retén distribución G 56.87 x 1.78	GS	220442
547253115A	Salida de escape Orion	NFT	220642
025/251509/	Catalizador gases	NFT	220644
	Jgo. juntas caja velocidades 5ta.	VS	220450
056103483C	Junta tapa válvulas	CGT	220461
	Jgo. suplemento tapa de cilindros	AC	220685-0.50
	Jta. tapa cilindros competición (1.00)	NFT	220690-1.00
	Jta. tapa cilindros competición (1.20)	NFT	220690-1.20
	Jta. tapa cilindros competición (1.40)	NFT	220690-1.40
029/103608/1	Arandela tapón cárter A 14 x 20 x 1.5 A	AL 2 1	
	O'ring G 34.52 x 3.53	GS 2 2	
	Kit de retenes completo		R220400
026/109675//	Jgo. retén válvulas (8)	V	1 R220410V
048/10305/	Retén bancada 85 x 105 x 12	P	1 R220411P
026/103085/E	Retén distribución y árbol levas 32 x 47 x 10	P	3 R230113P

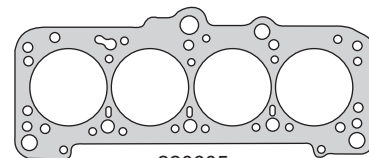

220605

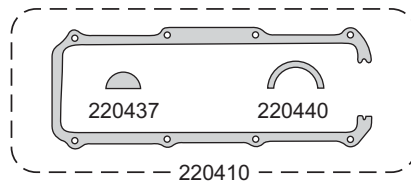

220410

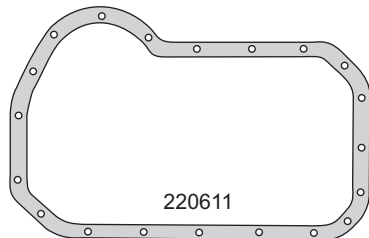

220611

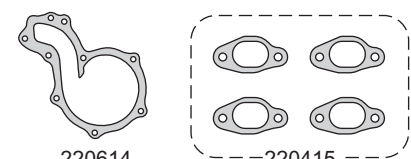

220614

220415



220417



220617



220418

220419

220618

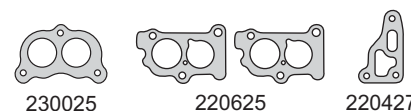

230025

220625

220427

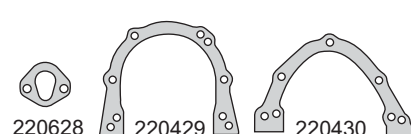

220628

220429

220430

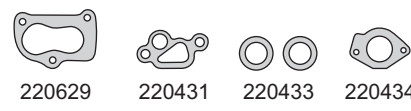

220629

220431

220433

220434



220641

A 14 x 20 x 1.5 A

G 56.87 x 1.78

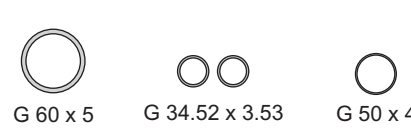

G 60 x 5

G 34.52 x 3.53

G 50 x 4

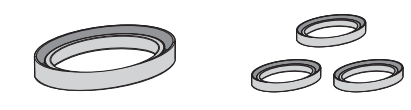

R220411P

R230113P

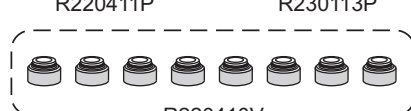

R220410V

VOLKSWAGEN/AUDI

VOLKSWAGEN



Motor/Engine	Cm³	HP	Ø
ZC/YJ/FL/FB FD/FH/FK	1457	65/85	76.5

Volkswagen: Passat - Golf - Dasher (USA)
Scirocco - Rabbit
Brasil 1974/82



Nº OE	Descripción/Description	Mat.	Ref.
	Jgo. de juntas para motor		220800
	Jgo. de juntas superior		220895
	Junta tapa cilindros Ø 79 ± 1.70	NFT 1 1	220805
	Jgo. de tornillos JTC (HAN12055/HAN12100)		B220400
	Junta tapa válvulas (3)	CG 1 1	220810
056103609A	Junta para cárter	CG 1 1	220411
056121041A	Bomba de agua	NB 1 1	220414
056129589A	Jgo. múltiple escape (4)	FCH 1 1	220415
056129717	Múltiple admisión	NB 1 1	220417
056129717	Salida de escape	NFT 1 1	230118
056121139A	Entrada agua	NB 1 1	220419
	Base carburador	NB 1 1	220825
056115441	Base filtro aceite	NB 1 1	220427
059127311A	Base bomba nafta	NB 1 1	220628
056103161	Bancada trasera	NB 1 1	220429
056103181	Bancada delantera	NB 1 1	220430
056905261	Base distribuidor	CB 2 2	220433
056121149	Termostato	NB 1 1	220434
056103491	Medialuna tapa cilindros	GS 1 1	220437
026121119	O´ring termostato G 50 x 4	GS 1 1	220438
056103489A	Cuello tapa válvulas superior	GS 1 1	220440
	Arandela A 14 x 18 x 1.5 A	AL 1 1	
	O´ring G 34.52 x 3.53	GS 2 2	
	O´ring distribución G 56.4 x 2	GS 1 1	
	Kit de retenes completo		R220400
026/109675	Jgo. retén válvulas (8)	V 1 1	R220410V
	Retén bancada 85 x 105 x 12	P 1 1	R220411P
026/103085/E	Retén distrib. y árbol de levas 32 x 47 x 10	P 1 1	R230113P

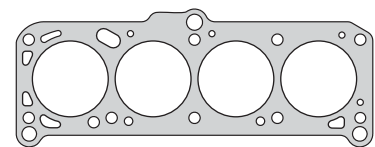

220805

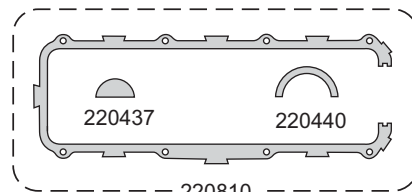

220810

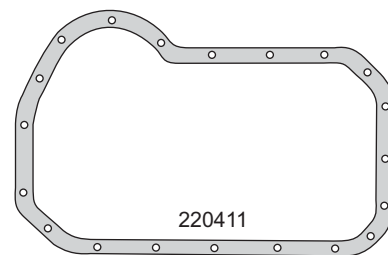

220411



220414

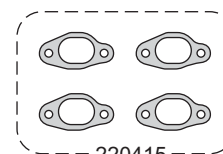

220415



220417



230118



220419



220427



220825



220628

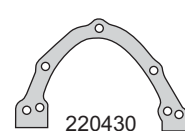

220430

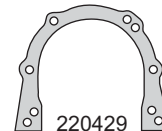

220429



220433



A 14 x 18 x 1.5 A



220434



G 34.52 x 3.53



G 56.4 x 2



G 50 x 4



R220411P



R230113P



R220410V

VOLKSWAGEN



Motor/Engine	Cm³	HP	Ø
ATU/AWF/AWG ABA/AKR/AGG	1984	115	82.5

Volkswagen: Golf - Passat 1992/96
Polo 1999/... - Golf Cabrio 1999/02
Desde Motor 031252



Nº OE	Descripción/Description	Mat.	Ref.
	Jgo. de juntas para motor		221000-R
037198012L	Jgo. de juntas superior	●	221095
	Jgo. de juntas superior (MLS)		221095 MLS
048103383B	Junta tapa cilin. Ø 83.5 ± 1.60	NFT 1 1	221007
037103383N	Junta tapa cilin. Ø 83.5 ± 1.50	MLS	221008
0291034831	Jgo. de tornillos JTC (HAN12055/HAN12100)		B220400
051103483E	Junta tapa válvulas superior (goma/metal)	ACP 1 1	230310
044103609D	Junta para cárter	NFT 1	220611
056103609A	Junta brida termostato	NB 1 1	230113
029129589B	Jgo. múltiple escape AGG (4)	FCH 1 1	230215
037253039D	Múltiple escape ATU/AKR	MLS	221015
037129717C	Múltiple admisión AWF/AWG/ATU	NFT 1 1	221017
048129717A	Múltiple admisión AKR/AGG/ATU	NFT 1 1	221417
028/115441/C	Base filtro de aceite	NB	1 230227
056103181	Bancada trasera	NB	1 220429
056103161	Bancada delantera	NB	1 220430
06A129717F	Entre colector admisión	NFT	221031
059121119	O´ring termostato G 50 x4	GS	2 220438
547253115A	Salida de escape	NFT	220642
N013849.2	Arandela tapón cárter A 14 x 20 x 1.5 A	AL	1
	O´ring G 28.17 x 3.53	GS	1
	O´ring G 34.59 x 2.62	GS	1
	O´ring G 36.09 x 3.53	GS	1 2
	O´ring G 56.87 x 1.78	GS	1
	Kit de retenes completo		R230300
027/109675	Jgo. retén válvulas (8)	V	1 R230210V
068/103171/F	Retén bancada 85 x 105 x 12	P	1 R220411P
068/103085E	Retén distrib. y árbol levas 32 x 47 x 10	P	3 R230113P

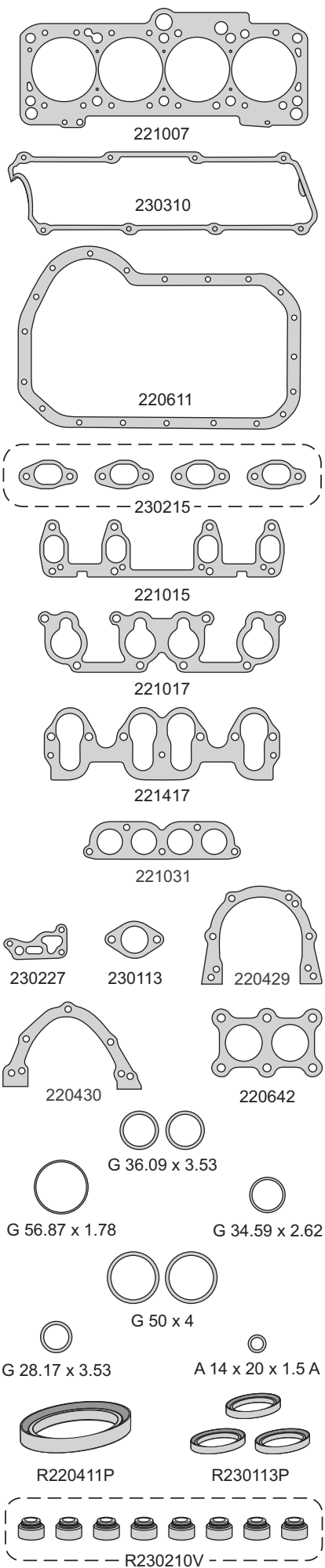

VOLKSWAGEN / AUDI

VOLKSWAGEN



Motor/Engine	Cm³	HP	Ø
AAB/AJA	2370	75/78	79.5

Volkswagen: Transporter T4 1992/99
Transporter Syncro 1992/98
Eurovan - Caravelle 1997/...

DIESEL



Nº OE	Descripción/Description	Mat.	Ref.
	Jgo. de juntas para motor		221101-R
	Jgo. de juntas superior		221195
074103383M	Jta. tapa cilindros Ø 81 ± 1.50	NFT	221107-1M
074103383N	Jta. tapa cilindros Ø 81 ± 1.60	NFT	221107-2M
074103383P	Jta. tapa cilindros Ø 81 ± 1.70	NFT	221107-3M
	Jgo. de tornillos JTC (HAN12055/HAN12100)		B221100
074103483B	Conj. junta tapa válvulas (9)	P	221110
074103609F	Junta para cárter	NFT	221111
	Frente motor - filtro aceite	NB	221112
	Junta brida termostato	NB	230113
	Frente motor - filtro aceite	SLS	221113
026129589A	Jgo. múltiple escape 230215/1 (5)	FCH	221115
074129717	Múltiple admisión	NFT	221117
	Arandela pico inyector A 6.5 x 13.7 x 1.25	AC	230922
	Acople bomba aceite	NB	221127
	Porta retén bancada trasero	NB	220429
	Chupador bomba aceite	NB	221129
	Anillo tapa válvulas inferior	GS	230230
	Guarnición goma	N	221130
	Anillo tapa válvulas superior	GS	230231
	Anillo sello goma G 58 x 2	GS	
	O´ring G 45 x 3	GS	
	O´ring G 23.47 x 2.62	GS	
	O´ring G 26.64 x 2.62	GS	
	O´ring G 64.77 x 2.62	GS	
	O´ring G 59.92 x 3.53	GS	
	O´ring G 98.02 x 3.53	GS	
	O´ring G 28.24 x 2.62	GS	
	O´ring G 21.89 x 2.62	GS	
	O´ring G 36.17 x 2.62	GS	
	O´ring G 34.52 x 3.53	GS	
	Arandela B 28 x 34 x 3 CN	CN	
	Arandela A 8 x 13 x 2.5 C	CU	
	Kit de retenes completo		R221100
026109675	Jgo. retén válvulas (10)	V	R221110V
068103051P	Retén bancada 85 x 105 x 12	V	R220411V
069115147C	Retén árbol de levas 35 x 48 x 7	V	R240013V
068103085E	Retén árbol de levas 32 x 47 x 10	V	R230113V

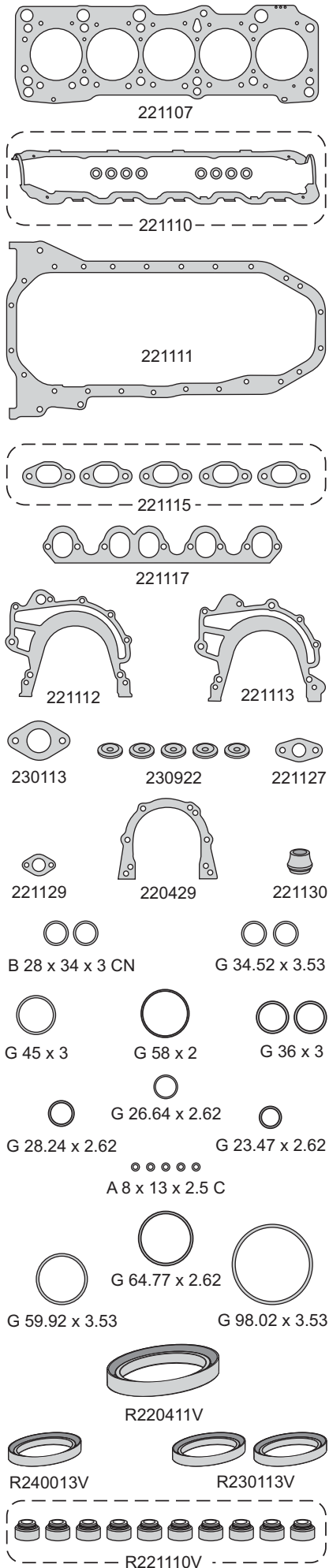

VOLKSWAGEN / AUDI

VOLKSWAGEN



Motor/Engine	Cm³	HP	Ø
RF/1F/FN/DT/JU	1595	70/75	81
RU/PP/EZA/ABN	1595	70/75	81
EW/EZ/HM/HN	1595	70/75	81
RE/RN/PP	1595	70/75	81
DS/DZ/PB/RF/RP	1781	95/112	81
EV/GX/AAM/ABS	1781	95/112	81

Audi: 80/100 - 80/100 Quattro - Coupe
Seat: Toledo - Ibiza - Córdoba 1991/97
Volkswagen: Scirocco 1970/92
 Golf - Passat - Jetta - Santana
 Caddy 1983/93 - Scirocco 1970/92
 Polo Classic 1995/...



Nº OE	Descripción/Description	Mat.	Ref.
	Jgo. de juntas para motor		221400-R
	Jgo. de juntas superior		221495
026103383	Junta tapa cilindros Ø 82.2 ± 1.70	NFT 1 1	230307
050103383A	Junta tapa cilindros Ø 82.5 ± 1.60	MLS	230308
	Jgo. tornillos tapa cil.		B220400
056103483C	Conj. tapa válvulas superior (3)	CG 1 1	220410
	Junta para cárter	NB 1 1	240611
049121041B	Bomba de agua	NB 2 2	220614
	Jgo. múltiple escape (4)	FCH 1 1	230215
	Múltiple admisión	NFT 1 1	220617E
	Múltiple admisión	NFT 1 1	221417
	Salida de escape	NFT 1 1	221418
056121139A	Entrada agua	NB 1 1	220419
028/115441/C	Base filtro aceite	NB 1 1	230227
	Junta base bomba nafta	NB 1 1	220628
056103181	Bancada trasera	NB 1 1	220429
056103161	Bancada delantera	NB 1 1	220430
029/15189/1	Bomba AC block	NB 1 1	220431
056103491	Media luna tapa cilindros	GS 1 1	220437
059/121/119	O´ring termostato G 50 x 4	GS 1 1	220438
056103489A	Cuello tapa válvulas superior	GS 1 1	220440
	Guarnición conducto admisión	N 1 1	220641
547253115A	Salida de escape Orion	NFT 1 1	220642
	Salida de escape	NFT 1 1	220645
	Arandela tapón cárter A 14 x 20 x 1.5 A	AL 1 1	
	Arandela A 10 x 14 x 1 C	CU 1 1	
	O´ring G 36.17 x 2.62	GS 1 1	
	O´ring G 37 x 3	GS 2 2	
	Kit de retenes completo		R220400
026/109675//	Jgo. retén válvulas (8)	V 1 1	R220410V
	Retén bancada 85 x 105 x 12	P 1 1	R220411P
026/103085/E	Retén distribución y árbol levas 32 x 47 x 10	P 3 3	R230113P

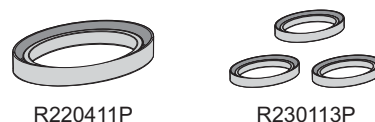
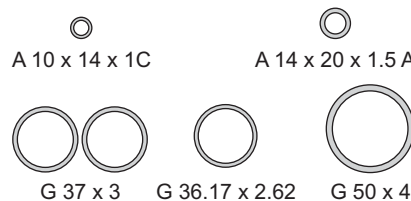
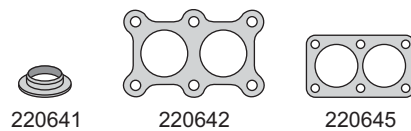
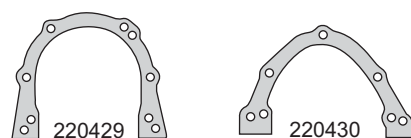
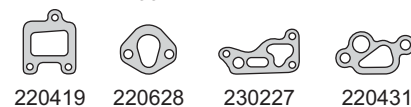
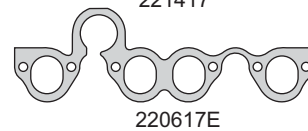
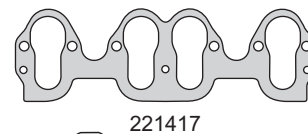
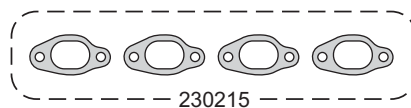
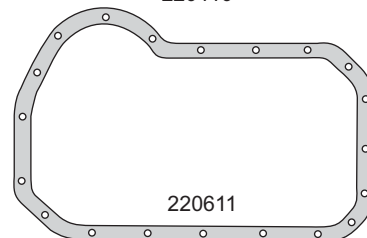
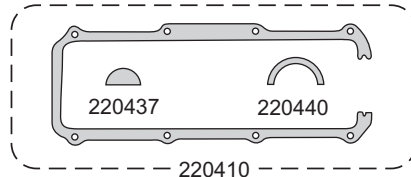
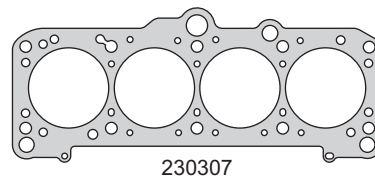

VOLKSWAGEN/AUDI

VOLKSWAGEN



Motor/Engine	Cm³	HP	Ø
AJT	2459	88	81
AGX	2459	75	81
ACV	2459	102	81

Volkswagen: Transporter T4 1998/...
Transporter Syncro TDI 1998/...
Transporter T4 TDI 1995/99
LT SDI 1996/...

DIESEL



Nº OE	Descripción/Description	Mat.	Ref.
	Jgo. de juntas para motor		221501-R
074103383R	Junta tapa de cilindros Ø 82 \pm 1.50	NFT	221507-1M
074103383S	Junta tapa de cilindros Ø 82 \pm 1.60	NFT	221507-2M
074103383T	Junta tapa de cilindros Ø 82 \pm 1.70	NFT	221507-3M
	Jgo. tornillos tapa cil. (HAN12055/HAN12100)		B221100
074103483B	Conj. junta tapa válvulas (9)	P	221110
074103609F	Junta para cárter	NFT	221111
	Junta frente motor - filtro aceite	NB	221112
	Junta brida termostato	NB	230113
	Junta frente motor - filtro aceite	SLS	221113
026129589A	Jgo. múltiple escape 23215/1 (5)	FCH	221115
079129717	Múltiple admisión	NFT	221117
	Arandela pico inyector A 6.5 x 13.7 x 1.25	AC	230922
	Acople bomba aceite	NB	221127
	Porta retén bancada trasero	NB	220429
	Chupador bomba aceite	NB	221129
	Anillo tapa válvulas inferior	GS	230230
	Guarnición goma	GS	221130
	Anillo tapa válvulas superior	GS	230231
	Anillo sello goma G 58.6 x 2	GS	
	O'ring G 45 x 3	GS	
	O'ring G 36 x 3	GS	
	O'ring G 23.47 x 2.62	GS	
	O'ring G 27 x 2	GS	
	O'ring G 65 x 3	GS	
	O'ring G 60 x 3.4	GS	
	O'ring G 97 x 4	GS	
	O'ring G 28.2 x 2.6	GS	
	Arandela B 26.4 x 32 x 2 CN	CN	
	Kit de retenes completo		R221100
026109675	Jgo. retén válvulas (10)	V	R221110V
068103051P	Retén bancada 85 x 105 x 12	V	R220411V
068103085E	Retén árbol de levas 32 x 47 x 10	V	R230113V
069115147C	Retén árbol de levas 35 x 48 x 7	V	R240013V

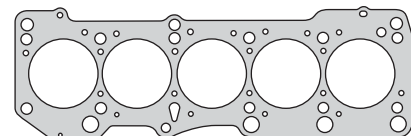

221507

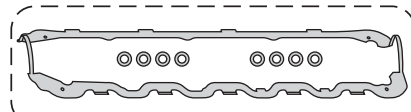

221110

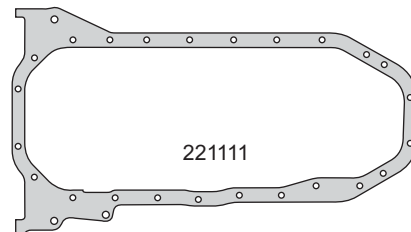

221111

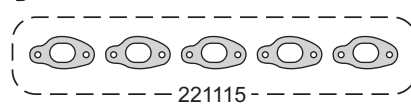

221115

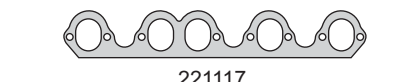

221117

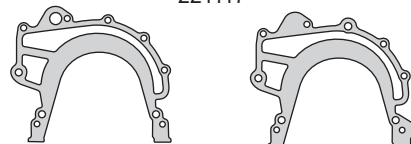

221112

221113



230113

230922

221127



221129

220429

221130



G 45 x 3

B 26.4 x 32 x 2

G 27 x 2



G 58.6 x 2

G 65 x 3



G 28.2 x 2.6

G 23.47 x 2.62



G 36 x 3



G 60 x 3.4

G 97 x 4



R220411V

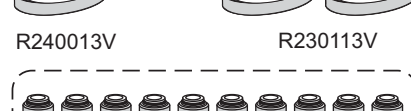

R240013V

R230113V

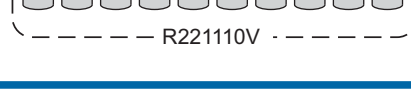

R221110V

VOLKSWAGEN / AUDI

VOLKSWAGEN



Motor/Engine	Cm³	HP	Ø
AAM/ABS/ADZ	1781	75/90	81

Seat: Cordoba - Toledo - Ibiza 1994/97
 Volkswagen: Vento 1992/97 - Passat 1991/96



Nº OE	Descripción/Description	Mat.	Ref.
	Jgo. de juntas superior		221695-R
026103383	Junta tapa cilindros Ø 82.2 ±1.70	NFT 1	230307
050103383A	Junta tapa cilindros Ø 82.5 ±1.60	MLS	230308
	Jgo. tornillos tapa cilin. (HAN12055/HAN12100)		B220400
0291034831	Junta tapa válvulas superior (goma/metal)	N 1	230310
	Múltiple escape	NFT 1	221615
	Múltiple admisión	NFT 1	220617E
059/121/119	O´ring termostato G 50 x 4	GS	220438
	Guarnición conducto admisión	N 1	220641
	O´ring G 36 x 3	GS 2	
026/109675//	Jgo. retén válvulas (8)	V 1	R220410V
026/103085/E	Retén distribución y árbol levas 32 x 47 x 10	P 1	R230113P

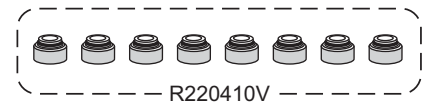
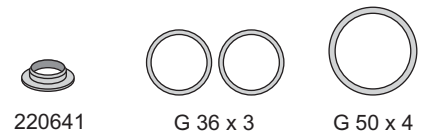
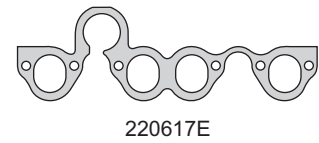
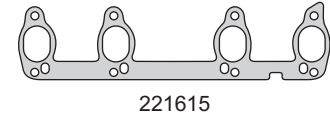
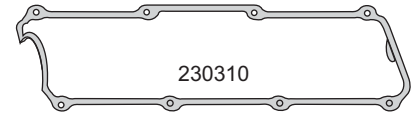
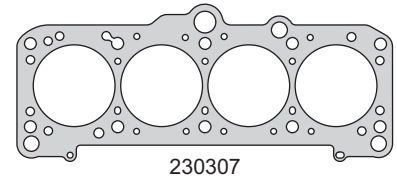

VOLKSWAGEN / AUDI

VOLKSWAGEN



Motor/Engine	Cm³	HP	Ø
AJP	1781	125	81
AGU/AJH/ARZ	1781	150	81
AJQ/APP	1781	180	81

Audi: A3 - A3 Quattro 1998/...
A6 1997/... - A3 Turbo 1996/...

Seat: Alhambra - Leon Turbo 1998/...

Volkswagen: Golf - Sharan 1997/... - Bora 2000/...
New Beetle - Passat Turbo 1999/...

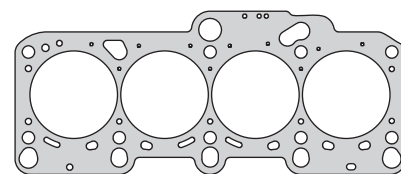

221707

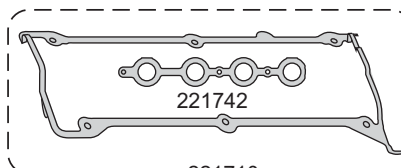

221742

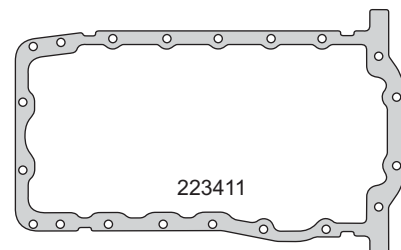

223411



221715



221717



221741



221718

230227

221829



220642

G 56.87 x 1.78

221744

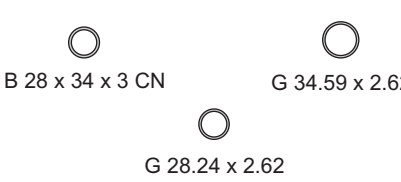

B 28 x 34 x 3 CN

G 34.59 x 2.62

G 28.24 x 2.62

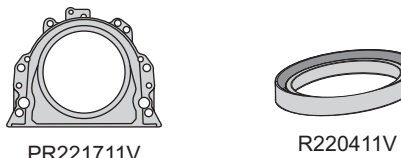

PR221711V

R220411V



R230113V

R240013P



R221710V

Nº OE	Descripción/Description	Mat.	Ref.
	Jgo. de juntas para motor		221700-R
	Jgo. de juntas superior		221795
	Jgo. de juntas superior (MLS)		221795 MLS
058103383K	Junta tapa cilindros Ø 82 \pm 1.50	NFT	1 1 221707
058103383K	Junta tapa cilindros Ø82.5 \pm 1.40	MLS	221708
	Jgo. tornillos tapa cilindros (HAR10168)		B221700
	Sellador líquido - caucho de silicona		TRN0280R
06A103609C	Conjunto de juntas tapa válvulas (2)	ACP	1 1 221710
	Junta para cárter	NFT	1 223411
058129717B	Múltiple escape	AC	1 1 221715
	Múltiple admisión	NFT	1 1 221717
	Salida de escape ARZ/AGU	GFT	1 1 221718
	Junta base filtro aceite	NB	1 230227
06A133398I	Guarnición bomba aceite	GS	221829
	Jgo. múltiple admisión (4) AGN	N	1 221741
533253115D	Cabezal tapa de cilindros	ACP	1 1 221742
	Salida de escape AGN	NFT	1 220642
	Junta	AC	1 1 221744
	O'ring G 56.87 x 1.78	GS	1
	O'ring G 34.59 x 2.62	GS	1
	O'ring G 28.24 x 2.62	GS	1
036109675	Arandela B 28 x 34 x 3 CN	CN	1
	Kit retenes completo		R221700
0681030518	Jgo. retén válvulas (20)	V	1 R221710V
	Porta retén bancada	V	PR221711V
	Retén bancada 85 x 105 x 12	V	1 R220411V
068103085E	Retén árbol de levas 32 x 47 x 10	V	2 R230113V
	Retén árbol de levas 35 x 48 x 7	P	1 R240013P

VOLKSWAGEN / AUDI

VOLKSWAGEN



Motor/Engine	Cm³	HP	Ø
AFY/ADR AEB/AJL/ANB	1781	115/125 150/180	81 81

Audi: A4 - A4 Turbo 1994/...
A6 - A6 Turbo 1995/...
Cabrio 1997/... - A6 Quattro 1999/...

Volkswagen: Passat 1996/99 - 1999/...
Passat Turbo 1996/98

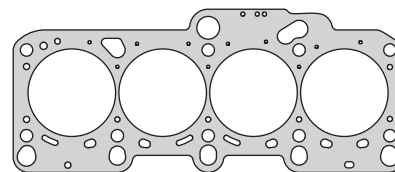

221707

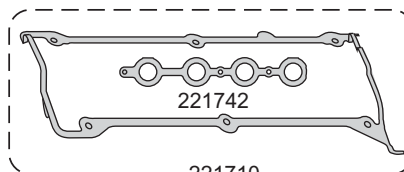

221742

221710

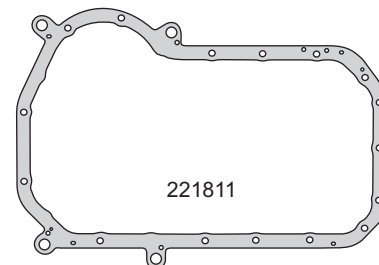

221811



221715



221717



221718



230227



221829

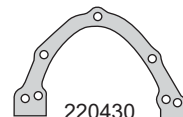

220430



220429



B 28 x 34 x 3 CN



A 14 x 20 x 1.5 A



G 36 x 3



G 56.87 x 1.78



G 50 x 4



G 28.24 x 2.62

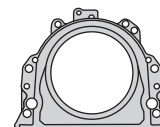

PR221711V



R220411V



R230113V



R240013P



R221710V

Nº OE	Descripción/Description	Mat.	Ref.
	Jgo. de juntas para motor		221800-R
	Jgo. de juntas superior		221895
058103383K	Junta tapa cilindros Ø 82 ± 1.50	NFT	1 221707
058103383K	Junta tapa cilindros Ø82.5 ± 1.40	MLS	1 221708
	Jgo. tornillos tapa cilindros (HAR10168)		B221800
06A103609C	Conj. juntas tapa válvulas (2)	ACP	1 1 221710
058103609	Junta para cárter	NFT	1 221811
058253039G	Múltiple escape	AC	1 1 221715
058129717B	Múltiple admisión	NFT	1 1 221717
	Salida de escape	GFT	1 221718
	Junta base filtro aceite	NH	230227
	Junta bancada delantera	NB	1 220429
	Guarnición bomba aceite	GS	221829
	Junta bancada trasera	NB	1 220430
026121119	O'ring termostato G 50 x 4	GS	1 220438
	Cabezal tapa de cilindros	ACP	1 1 221742
	O'ring G 56.87 x 1.78	GS	1
	O'ring G 28.24 x 2.62	GS	1 1
	O'ring G 36 x 3	GS	1 2
	Arandela tapón cárter A 14 x 20 x 1.5 A	AL	1
036109675	Arandela B 28 x 34 x 3 CN	CN	1
	Kit de retenes completo		R221700
0681030518	Jgo. retén válvulas (20)	V	1 R221710V
	Porta retén bancada	V	PR221711V
	Retén bancada 85 x 105 x 12	V	1 R220411V
068103085E	Retén árbol de levas 32 x 47 x 10	V	2 R230113V
	Retén árbol de levas 35 x 48 x 7	P	1 R240013P

VOLKSWAGEN/AUDI

VOLKSWAGEN



Motor/Engine	Cm³	HP	Ø
ABF	1985	150	82.5

Seat: Toledo 1994/99
Ibiza - Cordoba 1996/99
Volkswagen: Golf - Passat 1992/96
Hasta Motor 031251



Nº OE	Descripción/Description	Mat.	Ref.
	Jgo. de juntas para motor		221900-R
	Jgo. de juntas superior	●	221995
	Jta. tapa cilindros Ø 83.5 ± 1.70	NFT 1 1	221907
	Jgo. de tornillos JTC (HAN12055/HAN12100)		B221900
	Conj. junta tapa válvulas (3)	P 1 1	221910
	Junta para cárter	ACP 1 1	230311
	Tapa bomba de agua	NB 1 1	220614
	Jgo. múltiple escape (4)	NFT 1 1	221915
	Múltiple admisión	NFT 1 1	221917
	Base filtro aceite	NB 1 1	230227
	Junta bancada trasera	NB 1 1	220429
	Junta bancada trasera	NB 1 1	220430
	Junta base termostato	NB 1 1	221930
	Junta	N 1 1	221931
	Junta cierre de tapa cilindros	S 2 2	220437
	Múltiple admisión	NFT 1 1	221938
	Salida de escape	NFT 1 1	220642
	Guarnición cabezal	GS 1 1	221942
	O´ring G 28.24 x 2.62	GS 1 1	
	O´ring G 34.52 x 3.53	GS 2	
	O´ring G 36.17 x 2.62	GS 1 1	
	O´ring G 50 x 4	GS 1 1	
	O´ring G 60 x 5	GS 1 1	
	Arandela A 10 x 13 x 1 C	CU 1 1	
	Arandela A 14 x 18 x 1.5 A	AL 1 1	
	Arandela A 14 x 20 x 1 C	AL 1 1	
	Kit de retenes completo		R221900
	Jgo. retén válvula (16)	V 1	R260610V
	Retén de bancada 85 x 105 x 12	V 1	R220411V
	Retén de árbol de levas 32 x 47 x 10	V 3	R230113V

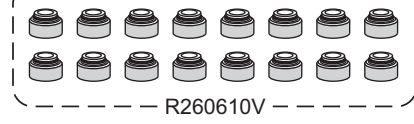
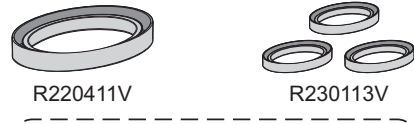
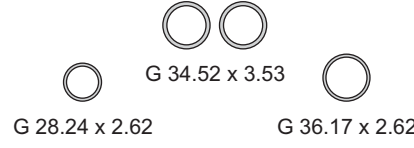
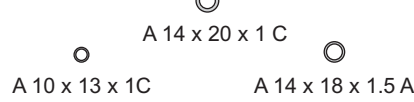
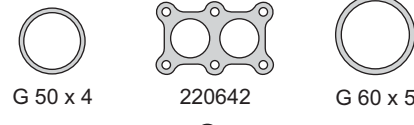
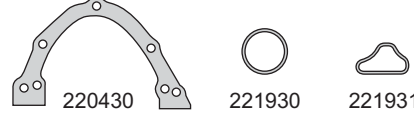
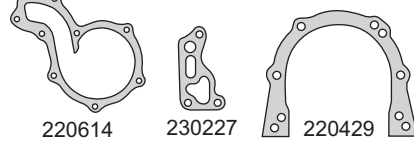
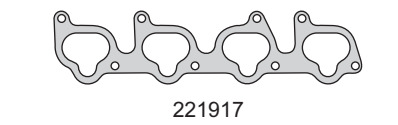
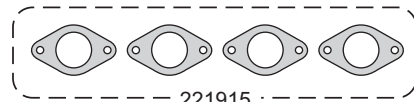
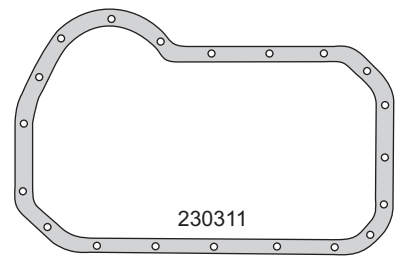
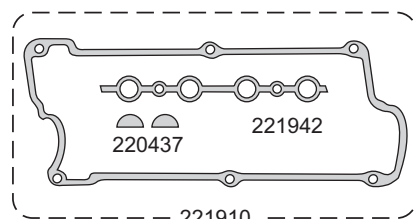
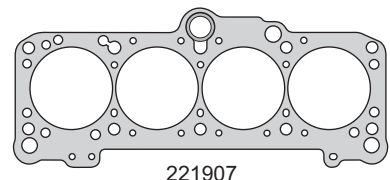

VOLKSWAGEN / AUDI

VOLKSWAGEN



Motor/Engine	Cm³	HP	Ø
AAU	1043	45	75
HZ/AAK/ACM	1043	45/50	75
2G/AAV/UN/NU	1272	55/70	75
ABD	1391	60	75

Seat: Ibiza 1993/94 - 1993/99
Volkswagen: Golf - Jetta 1985/91 - Polo 1985/94
 Golf - Jetta - Polo 1985/92-1987/94
 Golf - Vento 1991/94



Nº OE	Descripción/Description	Mat.	Ref.
	Jgo. de juntas para motor		222000-R
	Jgo. de juntas superior	●	222095
	Junta tapa cilindros Ø 76 ± 1.60 N.R.º	NFT 1 1	222007
	Jgo. de tornillos JTC (HAN12055/HAN12100)		B220400
	Junta tapa válvulas	GS 1 1	222010
	Junta para cárter	NH 1 1	222011
	Junta distribución	NB 1 1	222012
	Junta distribución	NB 1 1	222013
	Jgo. múltiple escape (2)	NFT 1 1	222015
	Múltiple admisión	SLS 1 1	222017
	Arandela goma	N 3 3	222029
	Junta bancada delantera	NB 1 1	220429
	Junta distribución	NB 1 1	222040
	Arandela A 14 x 20 x 1.5C	CU 1 1	
	O´ring G 60 x 4	GS 1 1	
	O´ring G 88.49 x 3.53	GS 1 1	
	O´ring G 29.82 x 2.62	GS 1 1	
	O´ring G 42.52 x 2.62	GS 1 1	
	O´ring G 42 x 4	GS 2 2	
	O´ring G 50 x 4	GS 1 1	
	Kit de retenes completo		R222000
	Jgo. retén válvulas (8)	V 1 1	R220410V
	Retén de bancada 85 x 105 x 12	V 1 1	R220411V
	Retén árbol de levas 32 x 47 x 10	V 2 2	R230113V

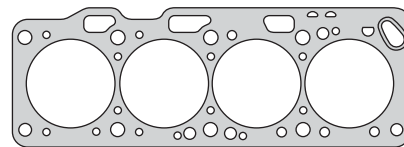

222007

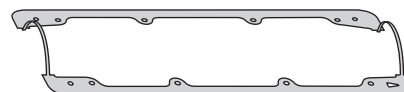

222010

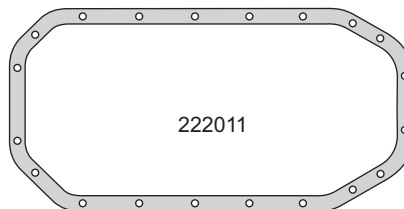

222011

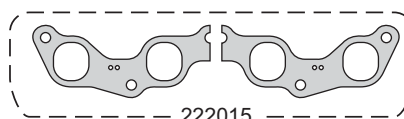

222015

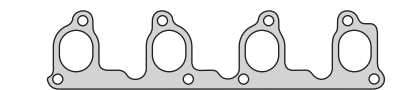

202017

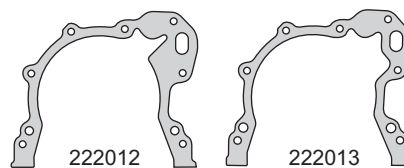

222012

222013



222029

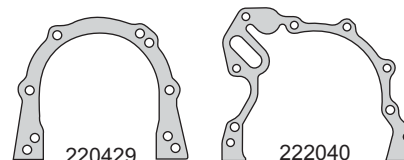

2220429

222040

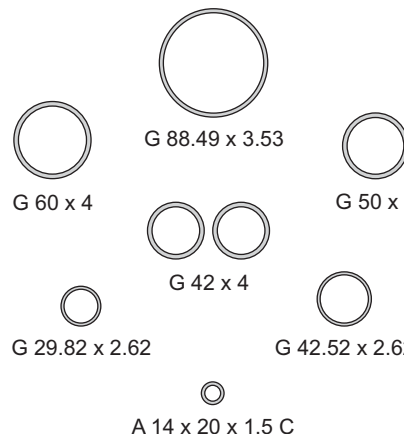

G 60 x 4

G 88.49 x 3.53

G 50 x 4

G 42 x 4

G 29.82 x 2.62

G 42.52 x 2.62

A 14 x 20 x 1.5 C



R220411V



R230113V

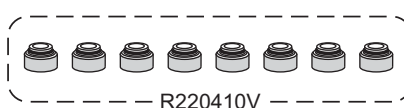

R220410V

VOLKSWAGEN / AUDI

VOLKSWAGEN



Motor/Engine	Cm³	HP	Ø
ABF	1985	150	82.5

Seat: Cordoba - Ibiza - Toledo 1993/99
 Volkswagen: Golf - Passat - Passat Variant 1992/97



Nº OE	Descripción/Description	Mat.	Ref.
	Jgo. de juntas para motor		222100-R
037198012F	Jgo. de juntas superior	●	222195
0481033837	Jta. tapa cilindros Ø 83.5 \pm 1.65	MLS 1 1	222108
037129583B	Jgo. de tornillos JTC (HAN12055/HAN12100)		B221900
0441036090	Junta para cárter	NFT	220611
03712958913	Jgo. múltiple escape (4)	NFT 1 1	221915
037129717E	Múltiple admisión	NFT 1 1	221917
0371297176	Múltiple admisión	NFT 1 1	221938
05332531150	Salida de escape	NFT 1 1	220642
013849150	Arandela tapón cárter A 14 x 20 x 1.5 C	CU	1
	Arandela A 10 x 13 x 1 C	CU	1 1
	Arandela B 28 x 34 x 3 CN	CN	1 1
	O'ring G 28.24 x 2.62	GS	1 1
	O'ring G 36.17 x 2.62	GS	1 1
	O'ring G 42.52 x 2.62	GS	1 1
059121119	O'ring bomba de agua G 50 x 4		1
	Kit de retenes completo		R221900
027109675	Jgo. retén válvulas (16)	V	1 R260610V
068103051P	Retén bancada 85 x 105 x 12	V	1 R220411V
068103085E	Retén distrib. y árbol levas 32 x 47 x 10	V	3 R230113V

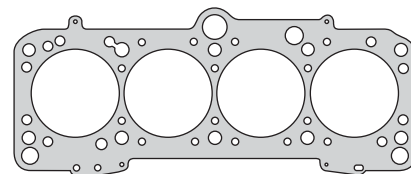

222108

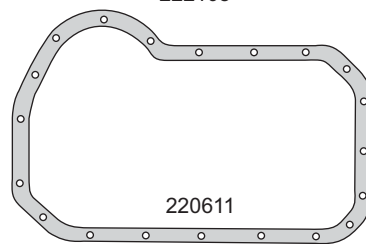

220611

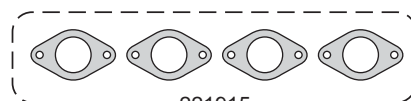

221915



221917



221938

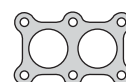

220642



A 14 x 20 x 1.5 C



B 28 x 34 x 3 CN



A 10 x 13 x 1 C



G 42.52 x 2.62



G 28.24 x 2.62



G 36.17 x 2.62



G 50 x 4



R220411V



R230113V



R260610V

VOLKSWAGEN / AUDI

VOLKSWAGEN



Motor/Engine	Cm³	HP	Ø
JS/HP/SK/KP	1994	113/115	81
KZ/KU/HY/KV	2226	115/137	81

Audi: 80 - 80 Quattro - Coupe 1983/86
90 - 100 1984/88 - 200 - 100
Coupe - 90 - 90 Quattro 1984/91

Volkswagen: Passat - Santana 1983/88
Passat - Quantum 1985/88



Nº OE	Descripción/Description	Mat.	Ref.
	Jgo. de juntas para motor		222200-R
	Jgo. de juntas superior	●	222295
	Junta tapa cilindros Ø 83 ± 1.70	NFT 1 1	222207
	Jgo. de tornillos JTC (HAN12055/HAN12100)		B222200
	Jgo. junta tapa válvulas (3)	CG 1 1	222210
	Junta para cárter	NFT 1 1	222211
	Junta distribución	NB 1 1	221112
	Junta brida termostato	NB 1 1	230113
	Jgo. múltiple escape 230215/1 (5)	FCH 1 1	221115
	Múltiple admisión	NFT 1 1	222217
	Base carburador	NB 1 1	222225
	Acople bomba aceite	NB 1 1	221127
056103181	Junta bancada trasero	NB 1 1	220429
	Chupador bomba aceite	NB 1 1	221129
	Junta brida	NB 1 1	221331
	Junta brida	NB 1 1	222231
	Junta base distribución	CB 1 1	220433
	Junta cierre tapa válvulas	GS 1 1	220437
	Junta tapa válvulas	GS 1 1	222238
	Junta cuello tapa válvulas	GS 1 1	220440
	Junta	NB 1 1	222240
	Junta	NFT 1 1	222241
	Arandela A 14 x 20 x 1.5 C	CU 1 1	
	Arandela A 18 x 22 x 1.5 A	AL 1 1	
	Arandela A 10 x 14 x 1 C	CU 1 1	
	Arandela A 14 x 18 x 1.5 C	CU 1 1	
	O´ring G 15.6 x 1.78	V 1 1	
	O´ring G 21.89 x 2.62	GS 1 1	
	O´ring G 50.39 x 3.53	GS 1 1	
	O´ring G 59.92 x 3.53	GS 1 1	
	O´ring G 98.02 x 3.53	GS 1 1	
	O´ring G 36.17 x 2.62	GS 1 1	
	Kit de retenes completo		R221100
	Jgo. retén válvulas (10)	V 1 1	R22110V
068103051P	Retén bancada 85 x 105 x 12	V 1 1	R220411V
069115147C	Retén distribución 35 x 48 x 7	V 1 1	R240013V
	Retén árbol de levas 32 x 47 x 10	V 2 2	R230113V

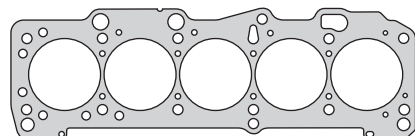

222207

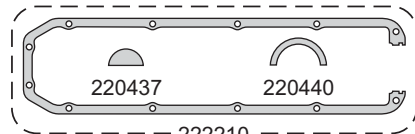

222210

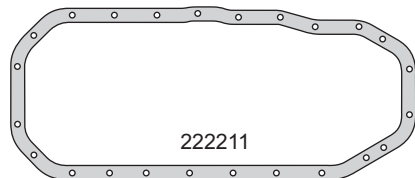

222211

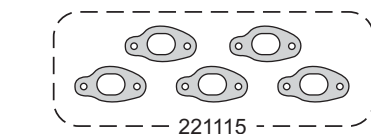

221115



222217

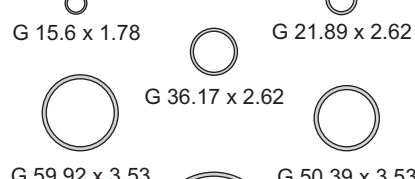
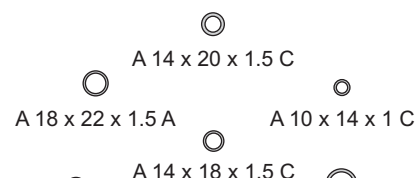
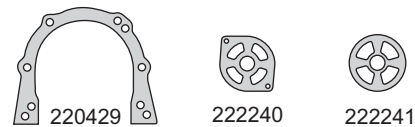
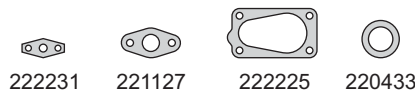
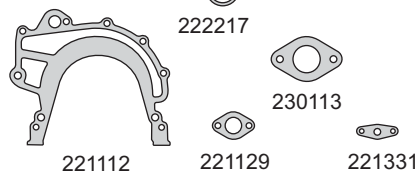

VOLKSWAGEN / AUDI

VOLKSWAGEN



Motor/Engine	Cm³	HP	Ø
ABK	1984	115	82.5
ABT	1984	90	82.5
AAE	1984	101	82.5

Audi: 80 Quattro - 100 1993/95
80 1991/95 - 100 1993/94



Nº OE	Descripción/Description	Mat.	Ref.
	Jgo. de juntas superior		222595-R
	Junta tapa cilindros Ø 83.5 ± 1.70	NFT	1 221907
	Jgo. tornillos tapa cil. (HAN12055/HAN12100)		B220400
0291034831	Junta tapa válvulas	N	1 230310
	Múltiple escape	NFT	1 221615
	Múltiple admisión	NFT	1 220617E
	Múltiple admisión	NFT	1 221417
	O´ring G 38 x 3	V	1
	O´ring G 36 x 3	GS	2
	Arandela A 14 x 20 x 1.5 C	CU	1
026/109675//	Jgo. retén válvulas (8)	V	1 R220410V
026/103085/E	Retén de árbol de levas 32 x 47 x 10	V	1 R230113V

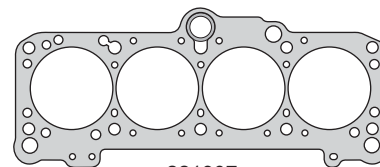

221907

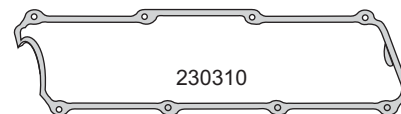

230310



221615



220617E



221417



G 38 x 3



G 36 x 3



A 14 x 20 x 1.5 C



R230113V



R220410V

VOLKSWAGEN



Motor/Engine	Cm ³	HP	Ø
AAE/AAD/ABK	1984	101/115	82.5

Audi: 80 Quattro - Coupe 1990/93
100 1990/93



Nº OE	Descripción/Description	Mat.	Ref.
	Jgo. de juntas superior		222695-R
	Junta tapa cilindros Ø 83.5 ± 1.70 N.R.	NFT 1	221907
	Jgo. tornillos tapa cilin. HAN12055/HAN12100		B220400
056103483C	Conj. junta tapa válvulas superior (3)	CG 1	220410
	Jgo. múltiple escape (4)	FCH 1	230215
	Múltiple admisión	NFT 1	220617E
	Múltiple admisión	NFT 1	221417
	Salida de escape	NFT 1	222618
056103491	Junta cierre de tapa cilindros	GS 1	220437
056103489A	Junta cuello tapa válvulas	GS 1	220440
	O´ring G 36 x 3	GS 2	
026/109675//	Jgo. retén válvulas (8)	V 1	R220410V
026/103085/E	Retén de árbol de levas 32 x 47 x 10	V 1	R230113V

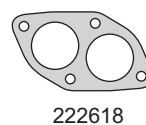
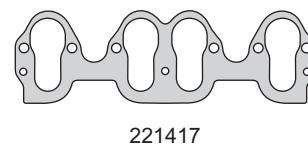
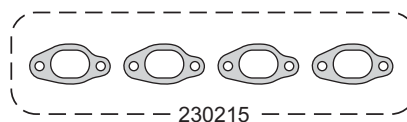
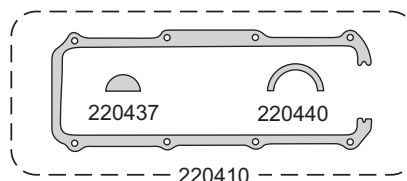
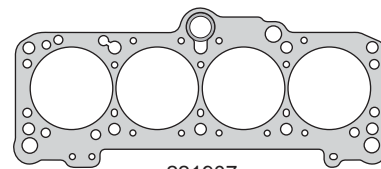

VOLKSWAGEN / AUDI

VOLKSWAGEN**taranto**

Motor/Engine

Cm³

HP

Ø

NF

2309

100/136

82.5

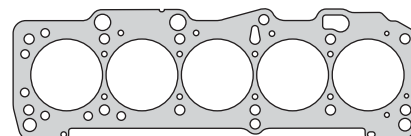
Audi: 100 - 200 Avant - 100 Avant - Coupe
Cabriolet - 80 - 90

222707

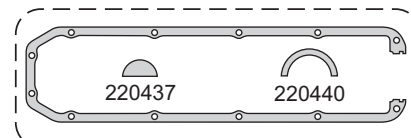

220437

220440

- 222210 -

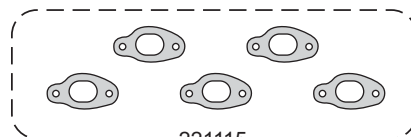

221115



222217



230113



222225



222231



220433



A 10 x 14 x 1 A



A 14 x 18 x 1.5 A



R230113V

Nº OE	Descripción/Description	Mat.	Ref.
	Jgo. de juntas superior		222795-R
	Junta tapa cilindros Ø 84 ± 1.70	NFT 1	222707
	Jgo. tornillos tapa cilin. (HAN12055/HAN12100)		B222200
	Jgo. junta tapa válvulas (3)	CG 1	222210
056103609A	Junta brida termostato	NB 1	230113
028/129589/B/	Jgo. múltiple escape 230215/1 (5)	FCH 1	221115
	Múltiple admisión	NFT 1	222217
	Base carburador	NB 1	222225
	Junta brida	NB 1	222231
056905261	Junta base distribución	CB 1	220433
056103491	Junta cierre de tapa cilindros	S 1	220437
056103489A	Junta cuello tapa de válvulas	S 1	220440
	Arandela A 10 x 14 x 1 A	AL 1	
	Arandela A 14 x 18 x 1.5 A	AL 4	
026/103085/E	Retén árbol de levas 32 x 47 x 10	V 1	R230113V

VOLKSWAGEN



Motor/Engine Cm³ HP Ø

AAR/NG 2309 133 82.5

Audi: 80 - 90 1985/94 -Cabrio - Coupe 1990/95
A6 1994/... - Coupe Quattro 1985/95
80 Quattro 1991/94 - 90 Quattro 1987/91



Nº OE	Descripción/Description	Mat.	Ref.
	Jgo. de juntas superior		222895-R
	Junta tapa cilindros Ø 84 \pm 1.70 N.R.	NFT 1	222707
	Jgo. tornillos tapa cilin. (HAN12055/HAN12100)		B222200
	Jgo. junta tapa válvulas (3)	CG 1	222210
056103609A	Junta brida termostato	NB 1	230113
028/129589/B/	Jgo. múltiple escape 230215/1 (5)	FCH 1	221115
	Múltiple admisión	NFT 1	222817
	Base carburador	NB 1	222225
	Junta brida	NB 1	222231
056905261	Junta base distribución	CB 1	220433
056103491	Junta cierre de tapa cilindros	GS 1	220437
	Múltiple admisión	NFT 1	222838
056103489A	Junta cuello tapa de válvulas	GS 1	220440
	Arandela A 10 x 14 x 1 A	AL 1	
	Arandela A 14 x 18 x 1.5 A	AL 4	
	Jgo. retén válvulas (10)	V 1	R221110V
026/103085/E	Retén árbol de levas 32 x 47 x 10	V 1	R230113V

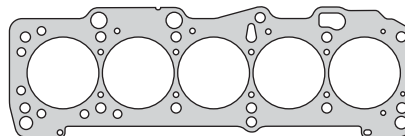

222707

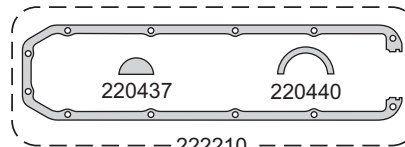

222210



222838

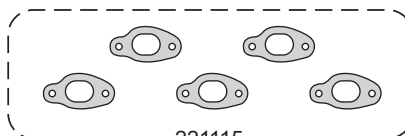

221115

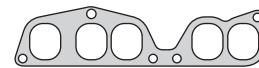

222817



230113



222225



222231



220433



A 10 x 14 x 1 A



A 14 x 18 x 1.5 A



R230113V

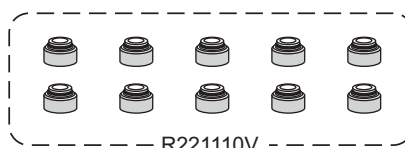

R221110V

VOLKSWAGEN / AUDI





VOLKSWAGEN

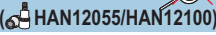

Motor/Engine	Cm³	HP	Ø
ABC/ACZ	2598	144/150	82.5
AAH/ABC/AEJ	2771	163/174	82.5

Audi: 80/80 Quattro - Cabriolet - 100/100 Quattro
 1991/94 - A4 - A4 Quattro - A6/A6 Quattro
 1994/... - 100/100 Quattro - 80/80 Quattro
 Coupe 1990/94



Nº OE	Descripción/Description	Mat.	Ref.
	Jgo. de juntas para motor		223000
	Jgo. junta tapa cil. Ø 83.5 \pm 1.80 (2) 	NFT	1 223007
	Jgo. tornillos tapa cilin. (6 )		B223000
	Jgo. múltiple escape (2) 	NFT	1 223015
	Jgo. múltiple admisión (2) 	NFT	1 223017
	Base carburador	NB	1 223025
	Entre colectores admisión 	NFT	1 223031

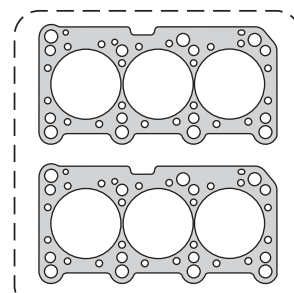

223007

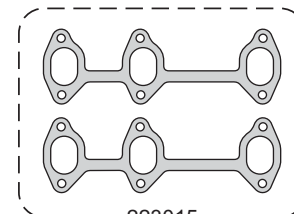

223015

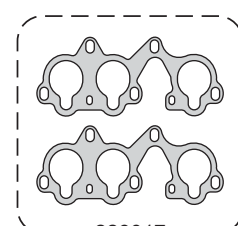

223017

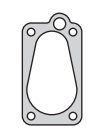

223025

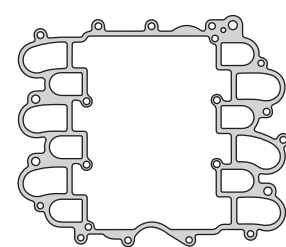

223031

VOLKSWAGEN / AUDI

VOLKSWAGEN



Motor/Engine Cm³ HP Ø

ABU 1598 75 76.5

Seat: Cordoba - Ibiza 1993/94

Volkswagen: Golf - Vento 1992/94



Nº OE	Descripción/Description	Mat.	Ref.
	Jgo. de juntas superior		223395-R
	Junta tapa cilindros Ø 77.5 ± 1.60 N.R.	NFT 1	223307
	Jgo. tornillos tapa cilin. (HAN12055/HAN12100)		B230300
	Junta tapa válvulas	GS 1	222010
032/253039/E	Múltiple escape	AC 1	230615
	Múltiple admisión	SLS 1	223317
	O´ring G 42.52 x 2.62	GS 1	
	O´ring G 42 x 4	GS 1	
	Jgo. retén válvulas (8)	V 1	R230210V
026/103085/E	Retén árbol de levas 32 x 47 x 10	V 1	R230113V

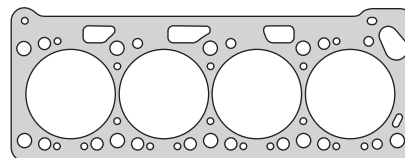

223307

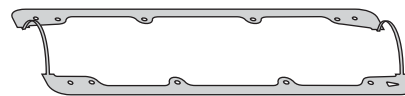

222010



230615



223317



G 42.52 x 2.62



G 42 x 4



R230113V



R230210V

VOLKSWAGEN / AUDI

VOLKSWAGEN



Motor/Engine	Cm³	HP	Ø
ALH/AHF/AGR	1896	90/110	79.5
AGP/AHF	1896	68/110	79.5

Audi: A3 TDI 1996/99
Skoda: Octavia TDI 1996/...
Volkswagen: Bora - Golf SDI/TDI 1997/...

DIESEL

Nº OE	Descripción/Description	Mat.	Ref.
	Jgo. de juntas para motor		223401-R
	Jgo. de juntas superior		223495
038103383G	Junta tapa cilindros Ø81 \times 1.50	NFT	223407-1M
038103383F	Junta tapa cilindros Ø81 \times 1.60	NFT	223407-2M
038103383L	Junta tapa cilindros Ø81 \times 1.70	NFT	223407-3M
038103383AL	Junta tapa cilindros Ø80.5 \times 1.55	MLS	223408-1M
038103383AM	Junta tapa cilindros Ø80.5 \times 1.63	MLS	223408-2M
038103383AN	Junta tapa cilindros Ø80.5 \times 1.71	MLS	223408-3M
	Jgo. de tornillos JTC (HAN12055/HAN12100)		B223400
	Sellador líquido - caucho de silicona		TRN0280R
	Junta para cárter	NFT	1 223411
037253039D	Jgo. múltiple escape (4)	FCH	1 1 230215
028129717D	Múltiple admisión	SLS	1 1 230217E
3A0253115	Salida de escape	AC	1 1 223418
038115441A	Soporte filtro de aceite	SLS	1 223429
	Guarnición salida aceite	N	1 1 221130
038/117070/	Junta inferior radiador	GS	3 3 223430
	Arandela tapa válvulas	NFT	3 3 223431
	Guarnición	GS	1 223432
	Junta brida	AC	1 223434
	Guarnición	GS	4 223435
046130/219A	Arandela pico inyector A 8 x 13 x 2.5 C	CU	4 4 230923
	Arandela A 14 x 20 x 1.5 C	CU	1
N/O28222/2	O´ring bomba aceite G 20 x 3.15	GS	1
	O´ring G 60 x 68 x 5.75	GS	1
038/121119/	O´ring bomba agua G 57 x 4	GS	1
N/900432/01	O´ring chupador block aceite G 10 x 2	GS	1
	Kit de retenes completo		R223400
027/106795	Jgo. retén válvulas (8)	V	1 R230210V
069115147C	Retén distribucion 35 x 48 x 7	V	1 R240013V
038103085E	Retén árbol de levas 32 x 47 x 10	V	1 R230113V

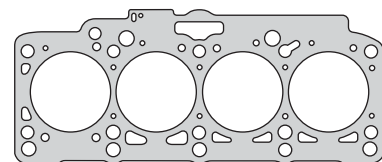

223407

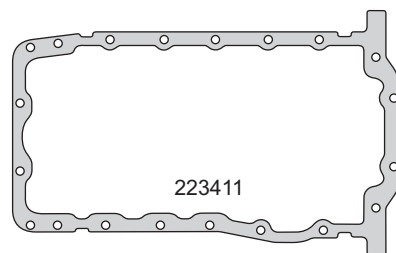

223411



230217E

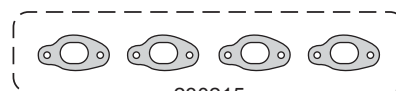

230215



223418

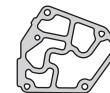

223429



221130



223430



223431



223432



223434



223435



G 20 x 3.15



G 57 x 4



G 60 x 68 x 5.75



A 14 x 20 x 1.5 C



A 8 x 13 x 2.5 C



G 10 x 2



R240013V



R230113V

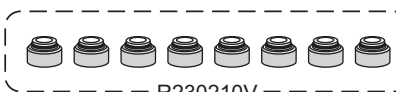

R230210V

VOLKSWAGEN / AUDI

VOLKSWAGEN



Motor/Engine	Cm³	HP	Ø
AXC	1896	85	79.5
ATJ/AUY/AXB	1896	105/115	79.5
BKE/AVF/AWX	1896	116/130	79.5

Audi: A4 TDI 2000/2004/...- A6 TDI 2001/...
Ford: Galaxy TDI 2000/...
Seat: Alhambra TDI 2000/...
Volkswagen: Passat TDI - Sharan TDI 1999/...
 Transporter TDI 2003/...



DIESEL

Nº OE	Descripción/Description	Mat.	Ref.
	Jgo. de juntas para motor		223501-R
038103383BL	Junta tapa cilindros Ø 80.5 \pm 1.45	MLS	223508-1M
038103383BM	Junta tapa cilindros Ø 80.5 \pm 1.53	MLS	223508-2M
038103383BN	Junta tapa cilindros Ø 80.5 \pm 1.61	MLS	223508-3M
	Jgo. tornillos tapa cilin. (HAN12055/HAN12100)		B223500
	Sellador líquido - caucho de silicona		TRN0280R
038103483	Junta tapa válvulas	GS 1	223510
	Junta para cárter	NFT 1	223411
0372530591	Múltiple escape	AC 1	223515
028/129717/D	Múltiple admisión	NFT 1	230217
3A0253115	Salida de escape	AC 1	223418
038115441A	Junta soporte filtro aceite	SLS 1	223429
	Guarnición salida aceite	N 1	221130
	Base bomba aceite a block	NB 1	220431
	Junta brida	AC 1	223434
N/O28222/2	O'ring bomba aceite G 20.22 x 3.53	GS 1	
	O'ring G 36 x 3	GS 2	
N/900432/01	O'ring chupador block aceite G 10 x 2	GS 1	
	Kit de retenes completo		R223400
027/106795	Jgo. retén válvulas (8)	V 1	R230210V
06A103171A	Porta retén bancada trasero	T	PR230211T
038103085E	Retén distribución 35 x 48 x 7	V 1	R240013V
038103085E	Retén árbol de levas 32 x 47 x 10	V 1	R230113V

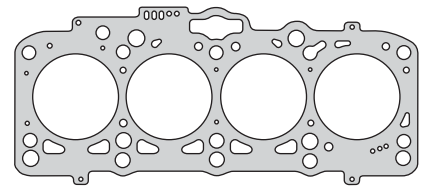

223508

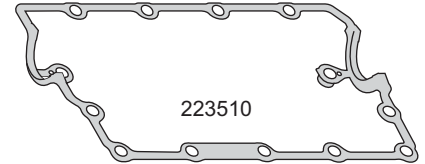

223510

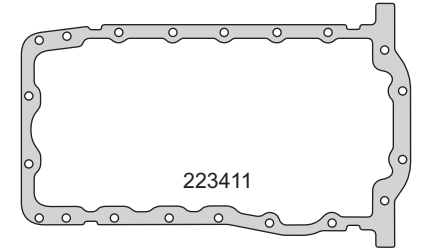

223411

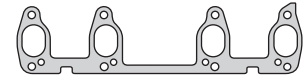

223515



230217



223418



221130



220431

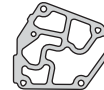

223429



223434



G 10 x 2



G 20.22 x 3.53



G 36 x 3

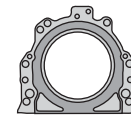

PR230211T



R240013V



R230113V



R230210V

VOLKSWAGEN/AUDI

VOLKSWAGEN



Motor/Engine	Cm³	HP	Ø
ADL/KR/PL	1781	129/139	81
KR	1781	130	81

Seat: Cordoba - Ibiza 1994/97
Toledo GTI 1991/94

Volkswagen: Golf 1989/91 - Scirocco 1985/92
Jetta 1986/87 - Passat - Corrado
1990/92



Nº OE	Descripción/Description	Mat.	Ref.
	Jgo. de juntas superior		223895-R
026103383	Junta tapa cilindros Ø 82.2 ± 1.70	NFT	1 230307
050103383A	Junta tapa cilindros Ø 82.5 ± 1.60	MLS	230308
	Jgo. tornillos tapa cilin. (HAN12055/HAN12100)		B221900
	Jgo. junta tapa válvulas (3)	P	1 221910
	Jgo. múltiple escape (4)	NFT	1 221915
	Múltiple admisión	NFT	1 221917
	Múltiple admisión	NFT	1 223817
	Junta	N	1 221931
056103491	Junta cierre de tapa cilindros	GS	2 220437
547253115A	Salida de escape	NFT	1 220642
	Guarnición cabezal	GS	1 221942
	O'ring G 28.24 x 2.62	GS	1
	O'ring G 36.17 x 2.62	GS	1
	Jgo. retén válvulas (16)	V	1 R223810V
	Retén de árbol de levas 32 x 47 x 10	V	1 R230113V

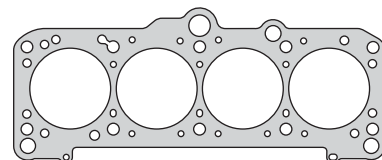

230307

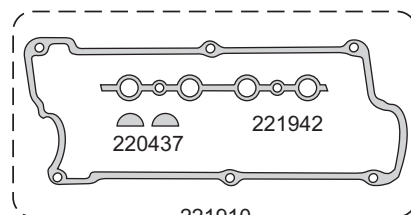

221942

220437

221910

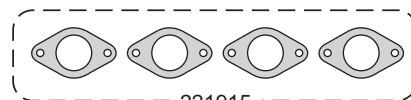

221915



221917



223817

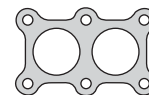

220642



221931



G 28.24 x 2.62



G 36.17 x 2.62



R230113V

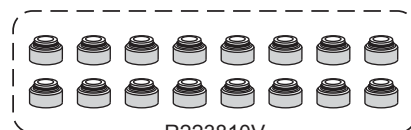

R223810V

VOLKSWAGEN



Motor/Engine	Cm ³	HP	Ø
2E	1984	115	82.5

Seat: Toledo - Ibiza - Cordoba 1991/94
Volkswagen: Golf GTI - Vento - Passat Corrado 1991/94



Nº OE	Descripción/Description	Mat.	Ref.
	Jgo. de juntas superior		223995-R
	Junta tapa cilindros Ø 83.5 ± 1.70	NFT 1	221907
	Jgo. tornillos tapa cilin. (HAN12055/HAN12100)		B220400
	Junta tapa válvulas	N 1	230310
	Jgo. múltiple escape (4)	FCH 1	230215
	Múltiple admisión	NFT 1	221417
	Guarnición salida de aceite	N 1	221130
	O'ring G 36.17 x 2.62	V 2	
	Jgo. retén válvulas (8)	V 1	R220410V
	Retén árbol de levas 32 x 47 x 10	V 1	R230113V

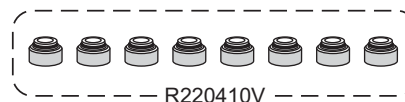
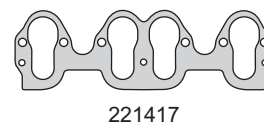
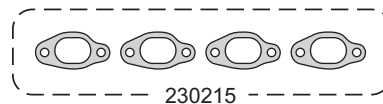
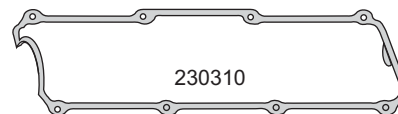
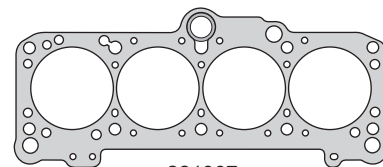

VOLKSWAGEN / AUDI

VOLKSWAGEN



Motor/Engine	Cm³	HP	Ø
BKR/BLM	1390	75	76.5
BAH/BJA/BLH	1598	100	76.5
BPA (SOHC) 8V	1598	100	76.5

Seat: Ibiza - Cordoba 2003/...

Volkswagen: Fox 2005/..., Polo 2003/05
Polo, Caddy 1997/01, Gol 2001/...
Lupo 2004/09, Fox 2005/...
Fox Route, Suran 2006/...
Voyage, Gol Trend



Nº OE	Descripción/Description	Mat.	Ref.
	Jgo. de juntas para motor		224000-R MLS
	Jgo. de juntas superior (MLS)	●	224095 MLS
	Junta tapa cilindros Ø 78 \pm 1.20	NFT	224007
032.103383.N	Junta tapa cilindros Ø 78 \pm 0.40	MLS 1 1	224008
	Jgo. de tornillos JTC (HAN12055/HAN12100)		B224000
	Sellador líquido - caucho de silicona		TRN0280R
	Junta tapa válvula	NB 1 1	224010
032.103601.AA	Junta para cárter	NB 1	224011
032.103161.K	Junta distribución	SLS 1	230512
030.121043.C	O'ring bomba de agua G 66.5 x 3.5	GS 1	230514
030.253039.K	Múltiple escape	AC 1 1	224015
030.129717.F	Jgo. anillo admisión G 36.3 x 40.8 x 5.4 (4)	GS 1 1	230617
	Salida de escape	NFT 1 1	230218
030.121005	Junta termostato	NB 1 1	224019
036.115111	Junta subida bomba aceite	SLS 1	230527
036.133073	Anillo mezcla a admisión G 64 x 69 x 5	GS 1	224031
	Junta para cárter	NB 1	224032
06A.103483.D	Guarnición llenado aceite	N 1 1	224033
036.103677	Guarnición sellado deflector	GS 1	230540
032.121665.A	Anillo caño bomba de agua	GS 1	230541
N.906175.01	O'ring asiento deflector G 60 x 4	GS 1 1	224035
032.121119.5	O'ring cierre termostato G 47 x 4	GS 2	224036
	O'ring salida termostato a block G 30.8 x 3.7	GS 1	224037
035.906149.A	O'ring pico inyector G 7.52 x 3.53	GS 8 8	224043
030.133026	Jgo. guarnición asiento inyector (4)	GS 1	224044
N.908560.01	Arandela tapón cárter A 14 x 20 x 1.5 A	AL 1	
1H0.121687.A	O'ring llenado de agua G 28.17 x 3.53	GS 1	
032.121666	O'ring caño unión bomba G 36.09 x 3.53	GS 1	
N.907653.01	O'ring acople retorno radiador G 32 x 4	GS 2	
	Kit de retenes completo		R224000
036.109675	Jgo. retén válvulas (8)	V 1	R224010V
030.103170	Porta retén bancada trasero	T 1	PR224011T
036.103085.E	Retén árbol de levas 32 x 42 x 7	V 1	R230512V
036.103085.G	Retén bomba de aceite 32 x 42 x 7	V 1	R230512V

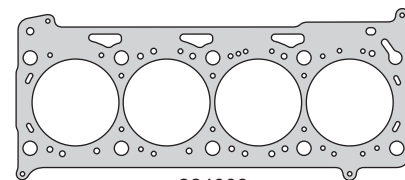

224008

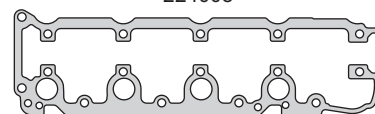

224010

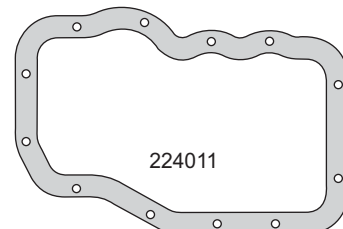

224011

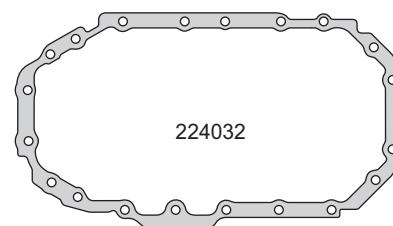

224032



224015



230617

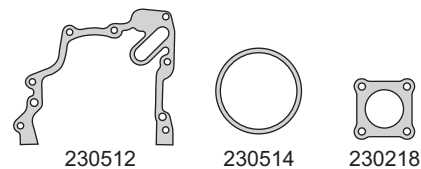

230512

230514

230218

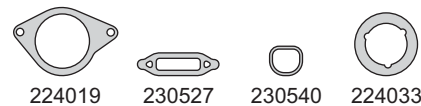

224019

230527

230540

224033

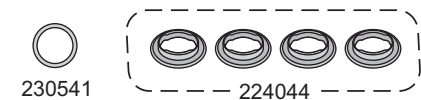

230541

224044



G 7.52 x 3.53

G 28.17 x 3.53



G 47 x 4

G 60 x 4

G 64 x 69 x 5



G 32 x 4

G 36.09 x 3.53

G 30.8 x 3.7

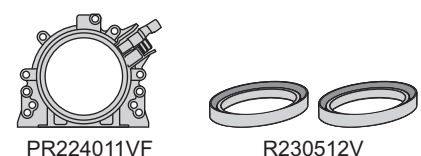

PR224011VF

R230512V



R224010V

VOLKSWAGEN



Motor/Engine	Cm³	HP	Ø
AQZ - BJE	999	71/72	67.1

Volkswagen: Fox 2003/...



Nº OE	Descripción/Description	Mat.	Ref.
	Jgo. de juntas para motor		224200 MLS
	Jgo. de juntas superior (MLS)	●	224295 MLS
	Junta tapa cilindros Ø 70 \pm 1.20	NFT	230507
032.103383.N	Junta tapa cilindros Ø 68 \pm 0.40	MLS	230508
032.103384.B	Jgo. de tornillos JTC (HAN12055/HAN12100)		B230500
032.103601.AA	Junta para cárter	NB	224011
032.103161.K	Junta distribución	SLS	230512
030.121043.C	O'ring bomba de agua G 66.27 x 3.53	GS	230514
030.253039.K	Múltiple escape	AC	224015
030.124717.F	Jgo. anillo admisión G 36.3 x 40.8 x 5.4 (4)	GS	230617
	Salida de escape	FCH	224218
030.121005	Junta termostato	NB	224019
036.115111	Junta subida bomba aceite	SLS	230527
036.133073	Anillo mezcla a admisión G 64 x 69 x 5	GS	224031
036.103677	Guarnición sellado deflector	GS	224032
06A.103483.D	Guarnición llenado aceite	GS	224033
0.32.121665.A	Anillo caño bomba de agua G 37.5 x 4	GS	224034
N.906175.01	O'ring asiento deflector G 60 x 4	GS	224035
032.121119.5	O'ring cierre termostato G 47 x 4	GS	224036
	O'ring salida termostato a block G 30.8 x 3.7	GS	224037
035.906149.A	O'ring pico inyector G 7.52 x 3.53	GS	224043
030.133026	Jgo. guarnición asiento inyector G 26.5 x 5.8 (4)	GS	224044
N.908560.01	Arandela tapón cárter A 14 x 20 x 1.5 A	AL	224010V
1H0.121687.A	O'ring llenado de agua G 28.17 x 3.53	GS	230512V
032.121666	O'ring caño unión bomba G 36.09 x 3.53	GS	230512V
N.907653.01	O'ring acople retorno radiador G 32 x 4	GS	
	O'ring G 20.22 x 3.53	GS	
	Kit de retenes completo		R224000
036.109675	Jgo. retén válvulas (8)	V	R224010V
030.103170	Porta retén bancada trasero	T	PR224011T
036.103085.E	Retén árbol de levas 32 x 42 x 7	V	R230512V
036.103085.G	Retén bomba de aceite 32 x 42 x 7	V	R230512V

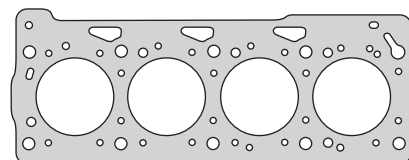

230508

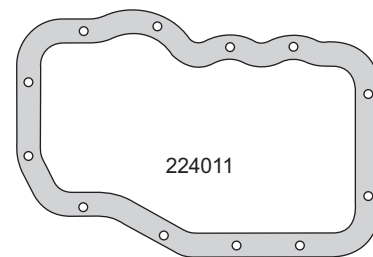

224011



224015



230617

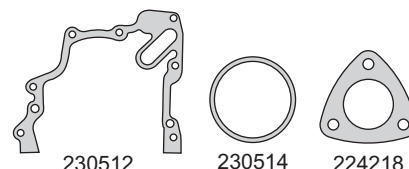

230512

230514

224218



224019

230527

224032

224033



224044



A 14 x 20 x 1.5 A

G 20.22 x 3.53



G 28.17 x 3.53

G 36.09 x 3.53

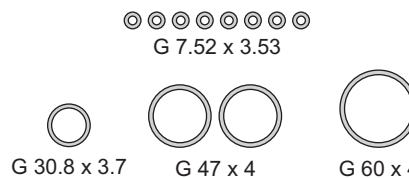

G 30.8 x 3.7

G 47 x 4

G 60 x 4



G 32 x 4

G 64 x 69 x 5

G 37.5 x 4

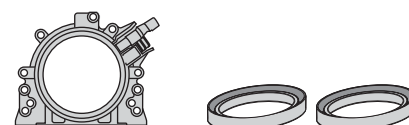

PR224011V

R230512V



R224010V

VOLKSWAGEN/AUDI

VOLKSWAGEN



Motor/Engine Cm³ HP Ø

AKL/AEH/APF 1595 100 81

Seat: Ibiza 2001/03 - Cordoba 2001/05
 Volkswagen: Derby - Bora - Passat - Golf - Polo 1999/...



Nº OE	Descripción/Description	Mat.	Ref.
	Jgo. de juntas para motor		224300-R
0613103383	Junta tapa cilindros Ø 82.5 ± 1.40 N.R.	MLS	1 224308
	Jgo. tornillos tapa cilindros (HAR10168)		B224100
051103483F	Junta tapa válvulas	N	1 230310
058253039G	Junta para cárter	NFT	1 221711
037253039F	Múltiple escape	AC	1 231115
06A103398F	Jgo. múltiple admisión (4)	GS	1 224317
	Junta	SLS	1 224330
	Junta	GS	1 224331
	Guarnición	GS	1 223432
	Junta	GS	1 224332
	Junta	GS	1 224333
	Junta	GS	1 224334
	Salida de escape	NFT	1 220642
	Junta enfriador aceite	SLS	1 221743
	O´ring G 20.22 x 3.53	GS	1
	O´ring G 20.30 x 2.62	GS	1
	O´ring G 28.17 x 3.53	GS	1
	O´ring G 43 x 4	GS	1
054121119	O´ring bomba de agua G 50 x 4	GS	2
	O´ring G 7.52 x 3.53	GS	8
	Kit de retenes completo		R224300
027109675	Jgo. retén válvulas (8)	V	1 R230210V
0618103171B	Porta retén bancada	V	1 PR221711V
068103085E	Retén distribución 32 x 42 x 7	V	1 R230512V
054115147B	Retén árbol de levas 35 x 48 x 7	P	1 R240013P

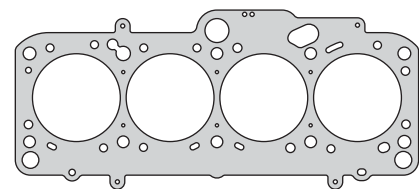

224308

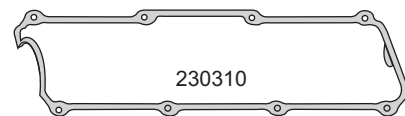

230310

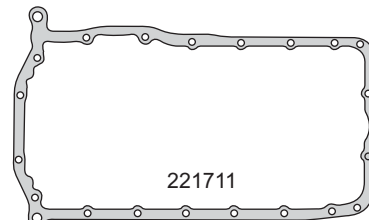

221711

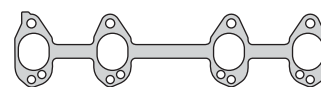

231115



224317



224330



224331



223432



224332



224333



224334

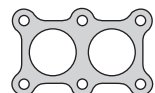

220642



221743



G 50 x 4



G 43 x 4



G 7.52 x 3.53



G 20.22 x 2.53



G 28.17 x 3.53



G 20.3 x 2.62

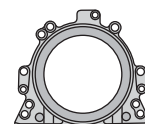

PR221711V



R240013P



R230512V



R230210V

VW - FORD



Motor/Engine Cm³ HP Ø

Audi 827 1984 107/115 82.5

Ford: Galaxy - Versailles - Verona
Escort 1992/96

Volkswagen: Carat - Quantum - Pointer - Gol
Golf - Santana 1989/...



Nº OE	Descripción/Description	Mat.			Ref.
	Jgo. de juntas para motor				230000-R
	Jgo. de juntas superior		●		230095
	Jgo. de juntas superior				230097
053103383	Junta tapa cilindros Ø 83.5 ± 1.70	NFT	1	1	230005
053103383	Jta. tapa cilindros Ø 83.5 ± 1.70	NFT			230007
	Jgo. de tornillos JTC (HAN12055/HAN12100)				B220400
056103483D	Conj. juntas tapa válvulas (3)	CG	1	1	220410
0491036091	Junta para cárter	NFT		1	220611
049121041B	Bomba de agua	NB		1	220614
056129589	Jgo. múltiple escape (4)	FCH	1	1	230215
056129717	Múltiple admisión	NB	1	1	220417
026129717	Múltiple admisión	NB	1	1	220617
841253115B	Salida de escape	FCH	1	1	220418
056121139A	Entrada agua	NB	1	1	220419
026/198569/18	Jgo. juntas carburador BROSOL PIERBURG	VS			230020
	Jgo. juntas inyección electrónica monopunto	VS			230024
	Base carburador	NB	1	1	230025
	Tapa carburador	NB			230026
056115441	Base filtro aceite	NB		1	220427
059127311A	Base bomba nafta	NB		1	220628
056103181	Bancada trasera	NB		1	220429
056103161	Bancada delantera	NB		1	220430
	Bomba aceite a block	NB		1	220431
	Brida intermedia admisión				220432
056905261	Base distribuidor	CB		2	220433
056121149	Termostato	NB		1	220434
N/901814/01	O'ring base radiador aceite G 60 x 5	GS		1	220436
056103491	Media luna tapa cilindros	GS	1	1	220437
059/121119/	Termostato o'ring G 50 x 4	GS		1	220438
059/12734/1	O'ring bomba nafta G 34.59 x 2.62	GS			220439
	O'ring válvulas t/cil. a calefactor G 34.52 x 3.53	GS	2	2	220639
	Arandela acople v/escape	H			230040
056102489A	Cuello tapa válvulas superior	GS	1	1	220440
	Guarnición conducto admisión	GS	1	1	220641
	O'ring porta retén distribución G 56.87 x 1.78	GS		1	220442
	Jgo. juntas con caja velocidades Audi 827	VS			230050
	Jgo. juntas caja velocidades 5ta.	CB			220450
	Jgo. juntas con caja velocidades MQ	VS			230051
056103483D	Junta tapa válvulas	CGT			220461
029/103608/1	Arandela tapón cárter A 14 x 20 x 1.5 A	AL		1	
	Kit de retenes completo				R220400
026/109675//	Jgo. retén válvulas (8)	V		1	R220410V
048/10305/	Retén bancada 85 x 105 x 12	P		1	R220411P
026/103085/E	Retén distrib. y árbol de levas 32 x 47 x 10	P		3	R230113P

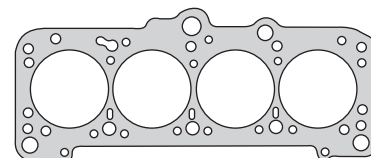

230005

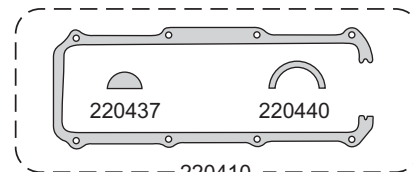

220437

220440

220410

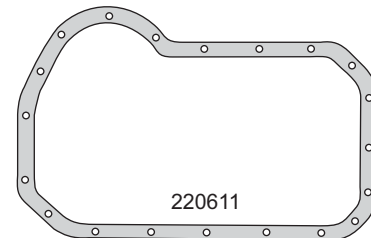

220611

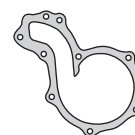

220614

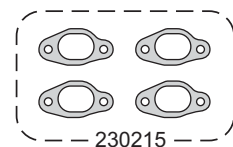

230215



220417



220617

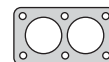

220418



220419



230025



220427



220628



220429

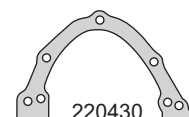

220430



220431



220433



220434



220641



A 14 x 20 x 1.5 A



G 56.87 x 1.78



G 34.52 x 3.53



G 60 x 5



G 50 x 4



R220411P

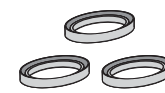

R230113P



R220410V

VOLKSWAGEN/AUDI

VOLKSWAGEN



Motor/Engine	Cm³	HP	Ø
CR/JK/JP/JR/JF JX/CS/CY	1588	49/54 70	76.5

Audi: 80 D/TD 1981/85
Volkswagen: Senda - Saveiro - Caddy
 Golf D/TD - Passat - Kombi
 Santana - 1981/86

DIESEL



Nº OE	Descripción/Description	Mat.	Ref.
	Jgo. de juntas para motor		230101-R
	Jgo. de juntas superior		230195-1M
	Jgo. de juntas superior		230195-2M
	Jgo. de juntas superior		230195-3M
	Jgo. de juntas superior		230195-4M
068103383BC	Junta tapa cilindros Ø 78 ± 1.40	NFT	1 230107-1M
068103383BD	Junta tapa cilindros Ø 78 ± 1.50	NFT	230107-2M
068103383BE	Junta tapa cilindros Ø 78 ± 1.60	NFT	230107-3M
056103483C	Junta tapa cilindros Ø 78 ± 1.70	NFT	230107-4M
049/103385/A	Jgo. de tornillos JTC (HAN12055/HAN12100)		B230100
056103483C	Conj. juntas tapa válvulas (3)	CG	1 1 220410
049/103609/1	Junta para cárter	NFT	1 220611
056103609A	Brida termostato	NB	2 2 230113
	Bomba de agua	NB	1 220614
056129589A	Jgo. múltiple escape (4)	FCH	1 1 230215
056129717	Múltiple admisión	NB	1 1 220417
841253115B	Salida de escape	NFT	1 1 230118
056121139A	Entrada agua	NB	1 220419
046/1302/9A	Arandela pico inyector	AC	4 4 230922
056115441	Base filtro aceite	NB	1 220427
	Junta base bomba nafta	NB	1 220628
	Bomba alimentación	NB	230128
056103181	Bancada trasera	NB	1 220429
056103161	Bancada delantera	NB	1 220430
	Junta bomba aceite	NB	1 220431
056905261	Base distribuidor	CB	2 220433
N/013849/2/	Arandela tapón cárter B 14 x 18 x 2 CN	CN	150034
056121149	Termostato	NB	1 220434
N/901814/01/	O'ring base radiador aceite G 60 x 5	GS	1 220436
056103491	Media luna tapa cilindros	GS	1 1 220437
059/121119/	Termostato o'ring G 50 x 4	GS	1 220438
056103489A	Cuello tapa válvula superior	GS	1 1 220440
	O'ring porta retén distribución G 56.87 x 1.78	GS	1 220442
	Jgo. juntas caja velocidades 5ta.	CB	220450
	Junta para cárter	CGT	220460
	Junta tapa válvulas	CGT	220461
	O'ring salida calefactor G 34.52 x 3.53	GS	2 2 220639
	Kit de retenes completo		R220400
026/109675//	Jgo. retén válvulas (8)	V	1 R220410V
048/103051/	Retén bancada 85 x 105 x 12	P	1 R220411P
026/103085/E	Retén distrib. y árbol levas 32 x 47 x 10	P	3 R230113P

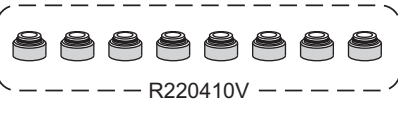
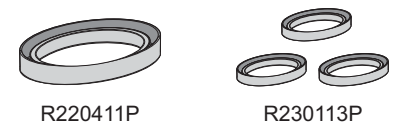
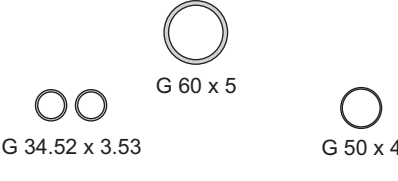
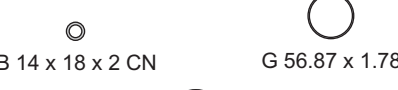
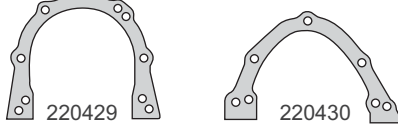
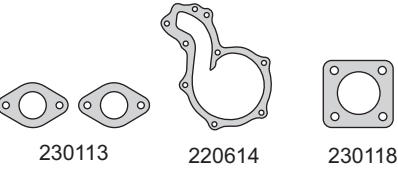
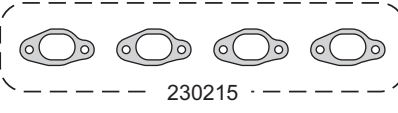
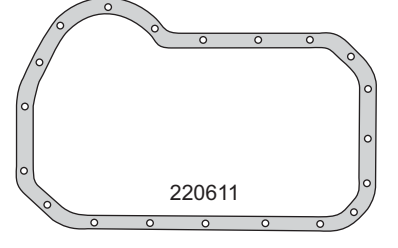
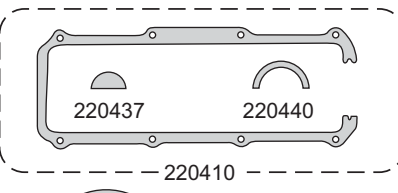
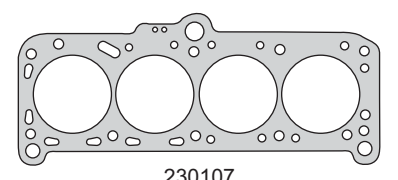

VOLKSWAGEN / AUDI

VOLKSWAGEN



Motor/Engine	Cm³	HP	Ø
1Y/AAZ/AEY	1896	64/75	79.5

Seat: Ibiza D/TD - Cordoba D/TD 1996/99
Toledo 1997/99

Volkswagen: Passat TD 1994/96 - Golf D/TD
Vento D/TD 1995/98 - Polo D
Caddy 1995/...

DIESEL



Nº OE	Descripción/Description	Mat.	REF.
	Jgo. de juntas para motor		230201-R
	Jgo. de juntas superior	●	230295-1M
	Jgo. de juntas superior		230295-2M
	Jgo. de juntas superior		230295-3M
	Jgo. de juntas superior (MLS)		230295-1M MLS
	Jgo. de juntas superior (MLS)		230295-2M MLS
	Jgo. de juntas superior (MLS)		230295-3M MLS
	Jta. tapa cilindros Ø 80.5 \pm 1.50	NFT 1	230207-1M
	Jta. tapa cilindros Ø 80.5 \pm 1.60	NFT	230207-2M
	Jta. tapa cilindros Ø 80.5 \pm 1.70	NFT	230207-3M
028/103383/BH	Junta tapa cilindros Ø 81 \pm 1.53	MLS	230208-1M
028/103383/BJ	Junta tapa cilindros Ø 81 \pm 1.57	MLS	230208-2M
028/103383/BK	Junta tapa cilindros Ø 81 \pm 1.61	MLS	230208-3M
068/103384/A	Jgo. de tornillos JTC (HAN12055/HAN12100)		B230100
028/103483/H/	Conj. junta tapa válvulas (7)	N 1 1	230210
037/115220/B	Junta para cárter con rompeolas	ACP	230211
	Junta para cárter	NFT	220611
	Junta brida termostato	NB 2 2	230113
049121041B	Bomba de agua	NB	220614
028/129589/B/	Jgo. múltiple escape (4)	NFT 1 1	230215
028/129717/D	Múltiple admisión	NFT 1 1	230217
	Salida de escape	NFT 1 1	230218
046/103219/A	Arandela pico inyector	AC 4 4	230922
028/115441/C	Base filtro aceite	NB	230227
056121139A	Base filtro aceite	NB	220427
	Junta base bomba nafta	NB	220628
	Bomba alimentación	NB	230128
056103181	Bancada trasera	NB	220429
028/103533/	Anillo tapa válvulas	GS 3 3	230230
056103161	Bancada delantera	NB	220430
	Casquillo árbol levas	GS 3 3	230231
	Bomba de aceite block	NB	220431
	Junta base distribución	CB	220433
N/901814/01/	O'ring base radiador aceite G 60 x 5	GS	220436
059/127311/A	O'ring calefactor G 34.52 x 3.53	GS 2 2	220639
	O'ring porta retén distribución G 56.87 x 1.78	GS	220442
	Arandela A 7 x 13 x 1 C	CU	4
	Arandela A 14 x 20 x 1 C	CU	2
	O'ring G 50 x 4	GS	2
	O'ring G 38 x 3	GS	1
	O'ring G 31.5 x 3.2	GS	1
	O'ring G 39 x 3	S	1
	O'ring G 40.87 x 3.53	GS	1
	O'ring G 20.22 x 3.53	GS	2
N/013849/2	Arandela tapa cárter B14 x 18 x 2 CN	CN	
	Kit de retenes completo		R230200
027/109675	Jgo. retén válvulas (8) 8 mm.	P	1 R220410P
027/109675	Jgo. retén válvulas (8) 7 mm.	V	1 R230210V
	Porta retén bancada trasero	T	PR230211T
068/103171/F	Retén bancada 85 x 105 x 12	V	1 R220411V
	Retén distrib. y árbol levas 32 x 47 x 10	P	3 R230113P

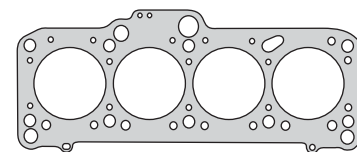

230207

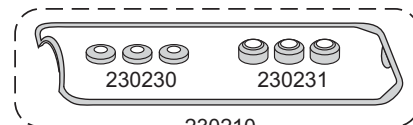

230210

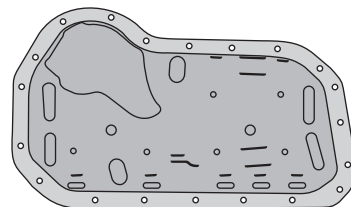

230211

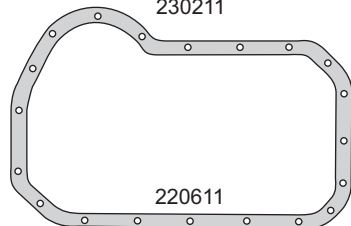

220611

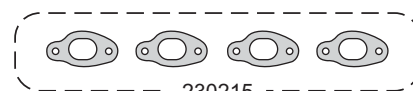

230215



230217



220614

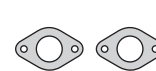

230113



230218

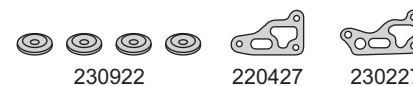

230922

220427

230227

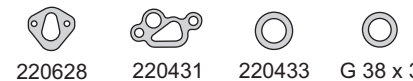

220628

220431

220433

G 38 x 3



220429

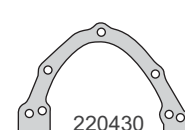

220430



G 34.52 x 3.53

G 50 x 4

G 56.87 x 1.78

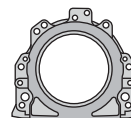

PR230211T



R220411V



R230113P

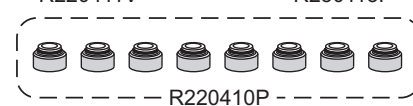

R220410P



R230210V

VOLKSWAGEN/AUDI

VOLKSWAGEN



Motor/Engine	Cm³	HP	Ø
ADA/ABM	1595	71/100	81
AAM/ABS/ADZ	1781	75/90	81
ADD	1781	75/90	81

Audi: 80 1993/96
Seat: Ibiza - Cordoba - Toledo 1993/94
Volkswagen: Golf - Vento - Polo Classic - Passat Jetta 1991/99



Nº OE	Descripción/Description	Mat.	Ref.
	Jgo. de juntas para motor		230300-R
	Jgo. de juntas para motor		230300-R MLS
	Jgo. de juntas superior		230395
	Jgo. de juntas superior (MLS)		230395 MLS
	Jta. tapa cilindros Ø 82.2 ± 1.70	NFT 1 1	230305
026103383	Jta. tapa cilindros Ø 82.2 ± 1.70	NFT	230307
050103383A	Jta. tapa cilindros Ø 82.5 ± 1.60	MLS	230308
	Jgo. de tornillos JTC (HAN12055/HAN12100)		B230300
0261034832	Junta tapa válvulas superior (goma/metal)	N 1 1	230310
044103609D	Junta para cárter (goma/metal)	ACP 1	230311
049121041B	Bomba de agua	NB 1	220614
	Bomba de agua (goma/metal)	AL/GS	230314
056129589	Jgo. múltiple escape (4)	FCH 1 1	230215
026129717	Múltiple admisión	NH	220617
	Múltiple admisión	NFT 1 1	230317
325/253137	Catalizador	CAC	230318
841253115B	Salida de escape	FCH	220418
547/253115/A	Salida caño de escape	FCH 1 1	220618
056121139A	Entrada agua	NB 1	220419
	Base filtro aceite	NB 1	230227
056115441	Base filtro aceite	NB 1	220427
059127311A	Base bomba nafta	NB 1	220628
056103181	Bancada trasera	NB 1	220429
056188161	Bancada delantera	NB 1	220430
	Base bomba de aceite a block	NB 1	220431
056905261	Base distribuidor	CB 2	220433
N/901814/01	O'ring base radiador aceite G 60 x 5	GS 1	220436
659/127311/A	O'ring salida t/cil. a calefactor G 34.52 x 3.53	GS 2 2	220639
	Guarnición conducto admisión	GS	220641
	O'ring porta retén distribución G 56.87 x 1.78	GS 1	220442
	Salida de escape		220642
	Catalizador gases	CNC 1 1	220644
059/121119/	O'ring termostato G 50 x 4	GS 1	
029/103608/1	Arandela cárter A 14 x 20 x 1 C	CU 1	
	Kit de retenes completo		R230300
	Jgo. retén válvulas Ø7 mm. (8)	V 1	R230210V
048/10305/	Retén bancada 85 x 105 x 12	P 1	R220411P
026/103085/E	Retén distrib. y árbol levas 32 x 47 x 10	P 3	R230113P

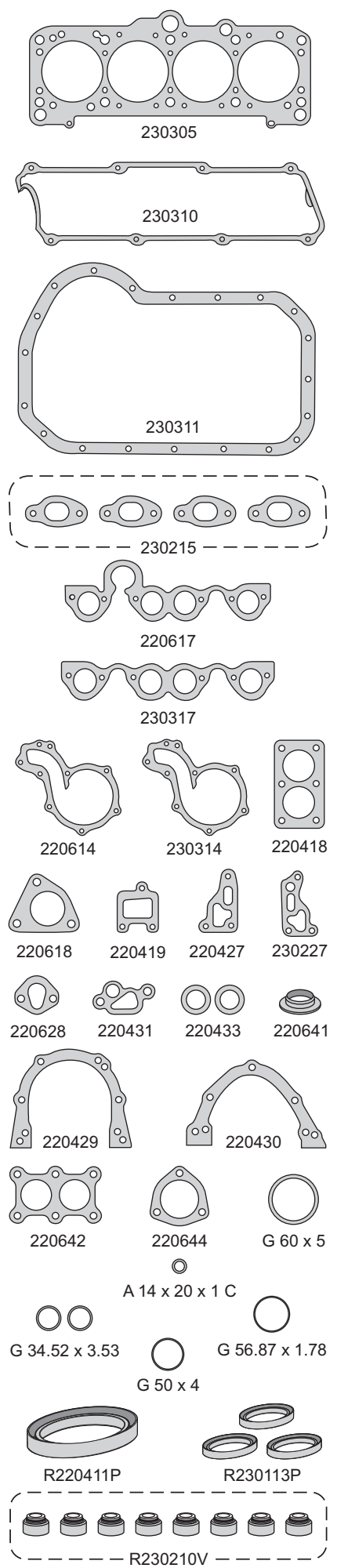

VOLKSWAGEN / AUDI

VOLKSWAGEN



Motor/Engine	Cm³	HP	Ø
AT (DOHC) 16V	999	69	67.08

Volkswagen: Gol 1000 - Saveiro 1998/...



Nº OE	Descripción/Description	Mat.	1	2	Ref.
	Jgo. de juntas para motor				230500-R
	Jgo. de juntas superior	●			230595
	Jgo. de juntas superior (MLS)				230595 MLS
036/103383/M	Junta tapa cilindros Ø 70 \pm 1.20	NFT	1	1	230507
036/103383/M	Junta tapa cilindros Ø 68 \pm 0.40	MLS			230508
	Jgo. de tornillos JTC (HAN12055/HAN12100)				B230500
036/103483/G	Conj. juntas tapa válvulas (2)	N	1	1	230510
	Junta para cárter	CG		1	230511
032/103161/C	Tapa distribución	SLS		1	230512
036/253039/C	Múltiple escape	AC	1	1	230515
	Jgo. anillo admisión G 46 x 50 x 4.8 (4)	GS	1	1	230517
377/253/115/C	Salida de escape	FCH	1	1	230518
036/115111//	Brida bomba aceite	SLS		1	230527
026/103181/B	Bancada trasera	NB		1	220429
036/103677	Guarnición sellado deflector	GS		1	230540
032/121665/A	Anillo caño bomba de agua	GS		1	230541
036/103483/D	Cabezal tapa de cilindros	GS	1	1	230542
	Guarnición goma	GS		1	230543
	O'ring G 60 x 4	GS		1	
	O'ring G 48 x 4.3	GS		2	
	O'ring G 7.8 x 2.5	GS		1	
	O'ring G 22.2 x 4	GS		2	
	O'ring G 36.09 x 3.53	GS		1	
N/013849/2/	Arandela tapón cárter A 14 x 20 x 1.5 C	CU		1	
	Kit de retenes completo				R230500
036/109675//	Jgo. retén válvulas (16)	V		1	R230510V
	Retén bancada 85 x 105 x 12	V		1	R220411V
068/103171/F	Porta retén bancada trasero	T			PR230211T
	Ret. distribución 32 x 42 x 7 (desde 06/00)	V		1	R230512V
028/103085//	Ret. comando vál. 32x47x10 (hasta 06/00)	P		3	R230113P
096/103085/2	Ret. comando vál. 37x47x10 (desde 06/00)	V			R230513V

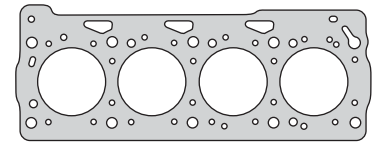

230507

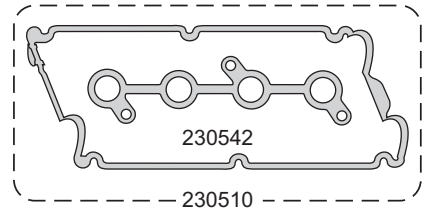

230542

230510

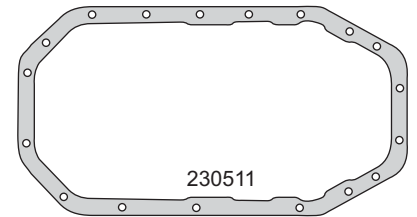

230511



230515



230517

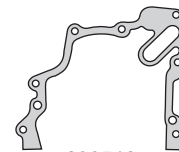

230512



230518



230527

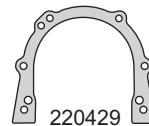

220429

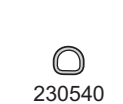

230540



230541



230541



G 36.09 x 3.53



G 7.8 x 2.5



G 60 x 4



G 48 x 4.3



G 22.2 x 4



A 14 x 20 x 1.5 C



R220411V

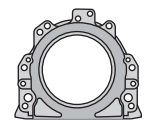

PR230211T



R230113P (hasta 06/00)

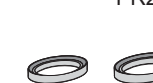

R230512V (desde 06/00)



R230513V (desde 06/00)

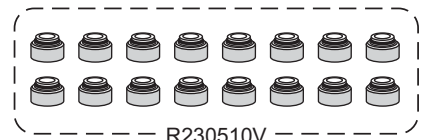

R230510V

VOLKSWAGEN/AUDI

VOLKSWAGEN



Motor/Engine	Cm³	HP	Ø
AER/ALL (SOHC) 8V	999	50	67.1

Seat: Ibiza - Cordoba 1996/...
Volkswagen: Gol 1000 - Saveiro - Polo 1995/...



Nº OE	Descripción/Description	Mat.	1	2	Ref.
	Jgo. de juntas para motor				230600-R
	Jgo. de juntas superior		●		230695
	Jgo. de juntas superior (MLS)				230695 MLS
036/103383/M	Junta tapa cilindros Ø 70 \pm 1.20	NFT	1	1	230507
036/103383/M	Junta tapa cilindros Ø 68 \pm 0.40	MLS			230508
	Jgo. de tornillos JTC (HAN12055/HAN12100)				B230600
030/103483/K	Conj. junta tapa válvulas (4)	N	1	1	230610
	Junta para cárter	CG		1	230511
	Junta distribución	SLS		1	230512
032/103161/H	Junta distribución	SLS		1	230612
032/253039/E	Múltiple escape	AC	1	1	230615
	Jgo. anillo admisión G 36.3 x 40.8 x 5.4 (4)	GS	1	1	230617
	Salida de escape	FCH	1	1	230618
036/115111//	Brida bomba aceite	SLS		1	230527
026/103181/B	Bancada trasera	NB		1	220429
	Arandela tapa de válvulas	GS	3	3	223630
036/103677	Guarnición sellado deflector	GS		1	230540
032/121665/A	Anillo caño bomba de agua G 37.5 x 45 x 5	GS		1	230541
	Guarnición goma	GS		1	230543
N/013849/2/	Arandela tapón cárter A14 x 20 x 1.5 C	CU		1	
	O´ring G 60 x 4	GS		1	
	O´ring G 48 x 4.3	GS		2	
	O´ring G 7.8 x 2.5	S		1	
	O´ring G 22.2 x 4	GS		2	
	O´ring G 36.5 x 3.53	GS		1	
	O´ring G 67 x 75 x 4	GS			
	Kit de retenes completo				R230600
	Jgo. retén válvulas (8)	V	1		R230210V
068/103171/F	Retén bancada trasero	V	1		R220411V
026/103171/B	Porta retén bancada trasero 85 x 105 x 11	T			PR230211T
028/103085	Retén distrib. 32 x 42 x 7 (desde 06/00)	V	1		R230512V
028/103085	Ret. cdo. vál. 32 x 47 x 10 (hasta 06/00)	P	2		R230113P

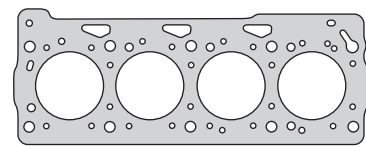

230507

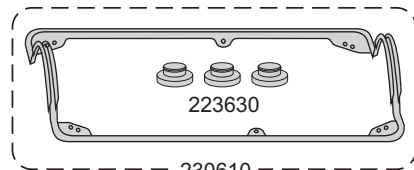

230610

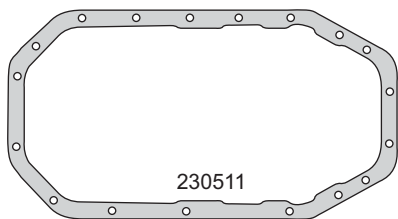

230511



230615



230617

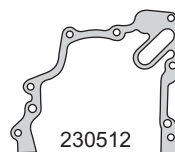

230512

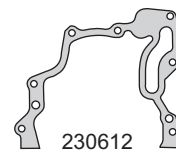

230612



230618



230527



220429



230540



230543



230541



G 60 x 4



G 67 x 75 x 4



G 48 x 4.3



A 14 x 20 x 1.5 C

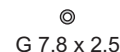

G 7.8 x 2.5



G 36.5 x 3.53



G 22.2 x 4

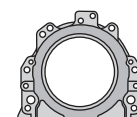

PR230211T



R220411V



R230113P (hasta 06/00)



R230512V (desde 06/00)

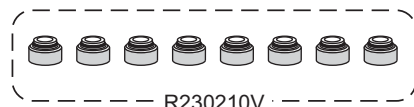

R230210V

VOLKSWAGEN



Motor/Engine	Cm³	HP	Ø
VV28 V6	2792	175	81
MB140.900 V6	2792	174	81
AAA V6	2792	174	81
ABV V6	2862	190	82

Ford: Galaxy 1995/02
Mercedes: V280 1998/...
Volkswagen: Passat VR6 - Golf VR6 1991/97
 Vento VR6 1992/97
 Jetta 1993/...



Nº OE	Descripción/Description	Mat.	Ref.
	Jgo. de juntas para motor		230700-R
	Jgo. de juntas superior	●	230795
021/103383/L/	Junta tapa cilindros Ø 83 ± 1.60 N.R.	NFT 1 1	230707
	Jgo. de tornillos JTC (HAN12055/HAN12100)		B230700
021/103483/O	Junta tapa válvulas	GS 1 1	230710
021/103609/B	Junta para cárter	NB 1 1	230711
	Jgo. múltiple escape (2)	CHA 1 1	230715
021/133227/J/	Múltiple admisión	SLS 1 1	230717
021/121119/A	Junta base termostato	GS 1 1	230719
021/115446/A/	Junta goma filtro de aceite	GS 1 1	230720
021/133227/H/	Múltiple entre colectores admisión	SLS 1 1	230729
075/121113/D	O´ring termostato G 59.92 x 3.53	GS	1
N903168/02	O´ring anillo sensor G 20.22 x 3.53	GS 4 4	
1HO/121687/A	O´ring G 28.17 x 3.53	GS	2
	O´ring G 10 x 2	GS	1
N/101392/01/	O´ring G 34.52 x 3.53	GS 4 4	
N/905315/01	O´ring G 36.17 x 2.62	GS	1
N/901368/02/	O´ring G 60 x 5	GS	1
038/117070/1	Anillo gomas 59 x 69 x 5	GS	
N/013849/2/	Arandela A 14 x 20 x 1.5 C	CU	1
	Kit de retenes completo		R230700
027/109675/1	Jgo. retén válvulas (12)	P 1	R230710P
068/198171/1	Retén bancada 85 x 105 x 12	P 1	R220411P
054/115147/B/	Retén distribución 35 x 48 x 7	V 1	R240013V

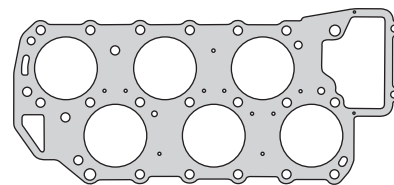

230707

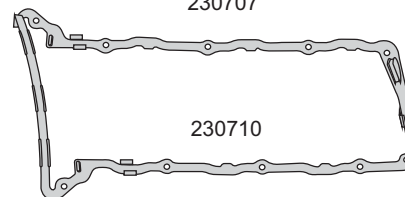

230710

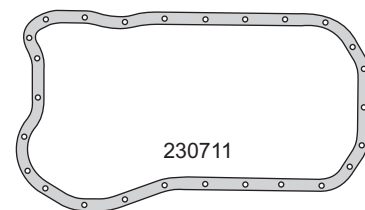

230711

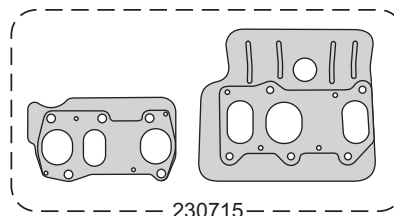

230715



230717



230719



230720

G 36.17 x 2.62

230719



G 34.52 x 3.53



G 59.92 x 3.53



G 20.22 x 3.53



G 28.17 x 3.53



G 36.17 x 2.62



G 60 x 5



A 14 x 20 x 1.5 C



R220411P



R240013V

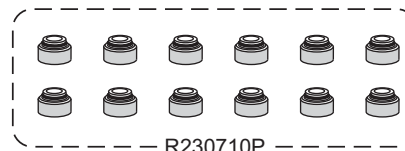

R230710P

VOLKSWAGEN / AUDI

VOLKSWAGEN**taranto**

Motor/Engine	Cm³	HP	Ø
1Z/AFF/AFN/AVG	1896	64/90	79.5
AHU/AEY/AHH	1896	90/110	79.5
AFF	1896	75	79.5
VW19N(1Z/AHU)	1896	90	79.5
VW19P (AFN)	1896	100	79.5

DIESEL

Audi: A4 - A6 D/TDI - CabrioTDI 1994/...
Ford: Galaxy TDI 1995/... - 1997/...
Seat: Ibiza - Cordoba SDI/TDI 1996/...
Volkswagen: Golf - Vento SDI/TDI 1993/95
 Sharan - Passat TDI
 Caddy SDI 1993/96



Nº OE	Descripción/Description	Mat.	Ref.
	Jgo. de juntas para motor		230901-R
	Jgo. de juntas superior		230995-1M
	Jgo. de juntas superior		230995-2M
	Jgo. de juntas superior		230995-3M
028.103383.BL	Junta tapa cilindros Ø 81 \times 1.45	NFT 1	230907-1M
028.103383.BN	Junta tapa cilindros Ø 81 \times 1.53	NFT	230907-2M
028.103383.BN	Junta tapa cilindros Ø 81 \times 1.61	NFT	230907-3M
028.103383.BP	Junta tapa cilindros Ø 81 \times 1.45	MLS	230908-1M
028.103383.BQ	Junta tapa cilindros Ø 81 \times 1.53	MLS	230908-2M
028.103383.BR	Junta tapa cilindros Ø 81 \times 1.61	MLS	230908-3M
049/103385/3	Jgo. de tornillos JTC (HAN12055/HAN12100)		B230100
0.28.103.483.G	Conj. junta tapa válvulas (7)	N 1 1	230910
044.103.609D	Junta para cárter	ACP 1	230311
056103609A	Brida termostato	NB 2 2	230113
028/129.589/B	Jgo. múltiple escape (4)	FCH 1 1	230215
028.129.717.D	Múltiple admisión	NFT 1 1	230217
059/121119/1	Arandela pico inyector A 6.5 x 13.7 x 1.25	AC	230922
046130219A	Arandela pico inyector	AC	230923
056/115441/1	Base filtro aceite	NB 1	230227
026/103161/B/	Base filtro aceite	NB 1	220427
028/115441/C/	Base bomba combustible	NB 1	230128
056103181	Porta retén bancada trasera	NB 1	220429
028/103536/A	Anillos tapa válvulas superior	GS 3 3	230230
056103161	Bancada delantera	NB 1	220430
028/1035331	Guarnición válvulas inferior	GS 3 3	230231
029/15189/1	Junta bomba de aceite	NB 1	220431
056905261	Base distribuidor	CB 1	220433
	O'ring calefactor G 35.3 x 3	GS	220639
	O'ring G 56.87 x 1.78	GS	220442
	Arandela A 7 x 12.5 x 1 C	CU 4	
	Arandela A 8 x 13 x 2.5 C	CU 4 4	
	O'ring G 50 x 4	GS 1	
	O'ring G 38 x 3	GS 1	
	O'ring G 39 x 3	S 1	
	O'ring G 30.8 x 3.7	GS 1	
	O'ring G 20.22 x 3.53	GS 2	
	O'ring G 34.52 x 3.53	GS 2 2	
	Arand. tapón cárter A 14 x 20 x 1C	CU 2	
	O'ring G 40.87 x 3.53	GS 1	
	Kit de retenes completo		R220400
026/109675//	Jgo. retén válvulas (8)	V 1	R220410V
026/109675/	Retén bancada 85 x 105 x 12	V 1	R220411V
068/103051/P/	Porta retén bancada trasero	T	PR230211T
068/103085/E/	Ret. distrib. y árbol de levas 32 x 47 x 10	P 3	R230113P

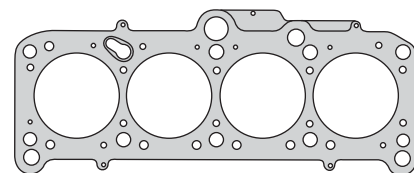

230907

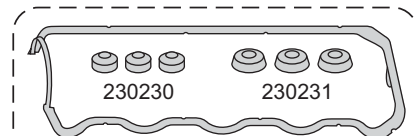

230230

230231

230910

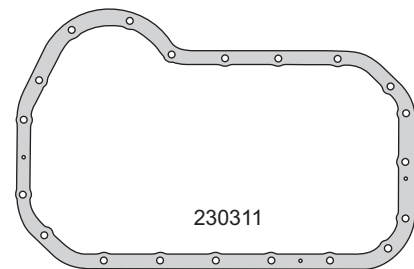

230311

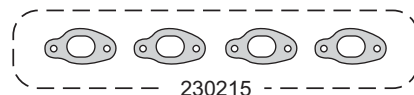

230215



230217

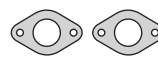

230113



230923



220427



230227



230128



220431



220429



220433

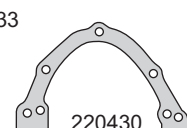

220430

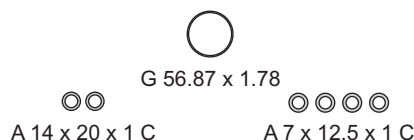

G 56.87 x 1.78



A 14 x 20 x 1 C



A 7 x 12.5 x 1 C



G 50 x 4



G 34.52 x 3.53



G 38 x 3



G 30.8 x 3.7



G 40.87 x 3.53



G 39 x 3

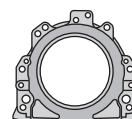

PR230211T



R220411V



R230113P

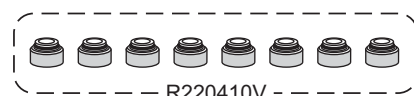

R220410V

VOLKSWAGEN



Motor/Engine	Cm³	HP	Ø
ATM/AZL/BBX	1984	115	82.5
AEG/AZG/AXA	1984	115	82.5
BEH/BER	1984	115	82.5
BSX	1984	109	82.5
BBX	1985	116	82.5

Seat: Alhambra - Cordoba - Ibiza 2000/...
Skoda: Fabia - Octavia 2000/...
Volkswagen: Golf - New Beetle 2002/...
 Transporter Minibus 2003/...
 Bora - Touran - Caddy 2006/...
 Polo BR 2002/...



Nº OE	Descripción/Description	Mat.	1	2	Ref.
	Jgo. de juntas para motor			●	231100-R MLS
06A1033831	Jgo. de juntas superior (MLS)		●		231195 MLS
06A103383-AN	Jta. tapa cilindros Ø 83.5 x 1.40 N.R. (HAR10168)	MLS	1	1	231108
	Jgo. tornillos tapa cilindros (TRN)				B224100
	Sellador líquido - caucho de silicona				TRN0280R
06A103483	Junta tapa válvulas	GS	1	1	231110
0261034832	Junta tapa válvulas	GS		1	230310
058253039C	Junta para cárter	NFT		1	223411
037253039F	Múltiple escape	CHA	1	1	231115
037129717C	Múltiple admisión	NFT	1	1	221017
06A129717A	Jgo. múltiple entre colectores admisión (5)	GS	1	1	231117
	Salida de escape	AC		1	231118
056611441	Junta base filtro aceite	NB		1	230227
06A1333981	Guarnición bomba aceite	GS			221829
06A129717F	Junta entre colectores	NFT		1	231132
06A1034830	Guarnición cierre llenado de aceite	GS	1	1	224033
028/129748	Junta mariposa aceleración	NH			231134
533253155	Salida de escape	NFT		1	220642
06A121119	O´ring bomba de agua G 53 x 4	GS		1	
026/12119	O´ring termostato G 50 x 4	GS		1	
	O´ring G 47.22 x 3.53	GS	1		
	Kit de retenes completo				R231100
027109675	Jgo. retén válvulas (8)	P		1	R230210P
06A103171A	Porta retén trasero	V			PR231111V
038103085E	Retén distribución 32 x 47 x 10	P		1	R220412P
038103085A	Retén árbol de levas 35 x 48 x 7	P		1	R240013P

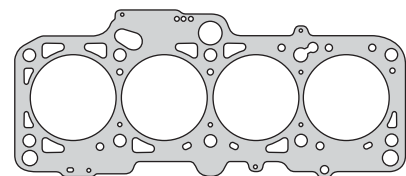

231108

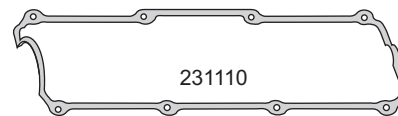

231110

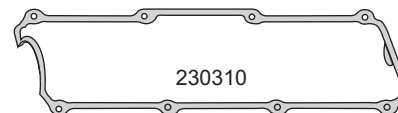

230310

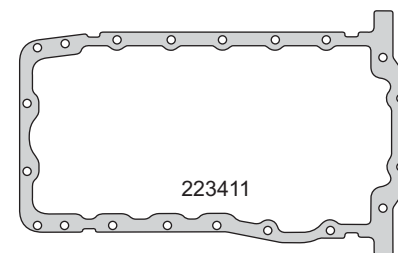

223411

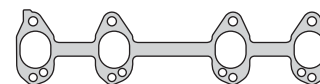

231115



221017



231132

231118

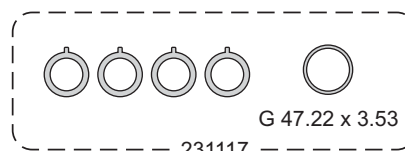

G 47.22 x 3.53

231117



230227

221829

224033

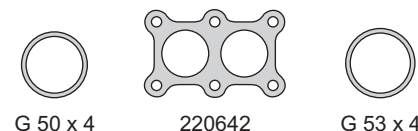

G 50 x 4

220642

G 53 x 4

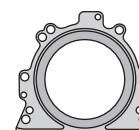

PR231111V



R240013P



R220412P



R230210V

VOLKSWAGEN / AUDI

VOLKSWAGEN



Motor/Engine	Cm³	HP	Ø
AT (SOHC) 8V	999	50/69	67.1

Volkswagen: Gol Power 2002/...



Nº OE	Descripción/Description	Mat.	Ref.
	Jgo. de juntas para motor		● 231200-R MLS
	Jgo. de juntas superior (MLS)	●	231295 MLS
036/103383/M	Junta tapa cilindros Ø 68 ± 0.40	MLS	1 1 230508
	Jgo. de tornillos JTC (HAN12055/HAN12100)		B230600
	Junta para cárter	CG	1 230511
032/103161/C	Tapa distribución	SLS	1 230512
030.253039.K	Múltiple escape	AC	1 1 224015
	Jgo. anillo admisión G 36.3 x 40.8 x 5.4 (4)	GS	1 1 230617
	Salida de escape	FCH	1 1 224218
036/115111//	Brida bomba aceite	SLS	1 230527
026/103181/B	Bancada trasera	NB	1 220429
	Guarnicion goma	GS	3 223630
036/103677	Guarnición sellado deflector	GS	1 230540
032/121665/A	Anillo caño bomba de agua G 37.5 x 45 x 5	GS	1 230541
	Guarnición goma	GS	1 230543
N/013849/2/	Arandela tapón cárter A14 x 20 x 1.5 C	CU	
	O´ring G 60 x 4	GS	1
	O´ring G 48 x 4.3	GS	2
	O´ring G 7.8 x 2.5	S	1
	O´ring G 22.2 x 4	GS	2
	O´ring G 36.5 x 3.53	GS	1
	O´ring G 43 x 4	GS	1
	O´ring G 20.22 x 3.53	GS	3
	Kit de retenes completo		R231200
	Jgo. retén válvulas (8)	V	1 R230210V
	Porta retén bancada trasero	VF	PR231211VF
028/103085	Retén distribución 32 x 42 x 7	V	1 R230512V
028/103085	Retén comando válvulas 32 x 42 x 7	V	1 R230512V

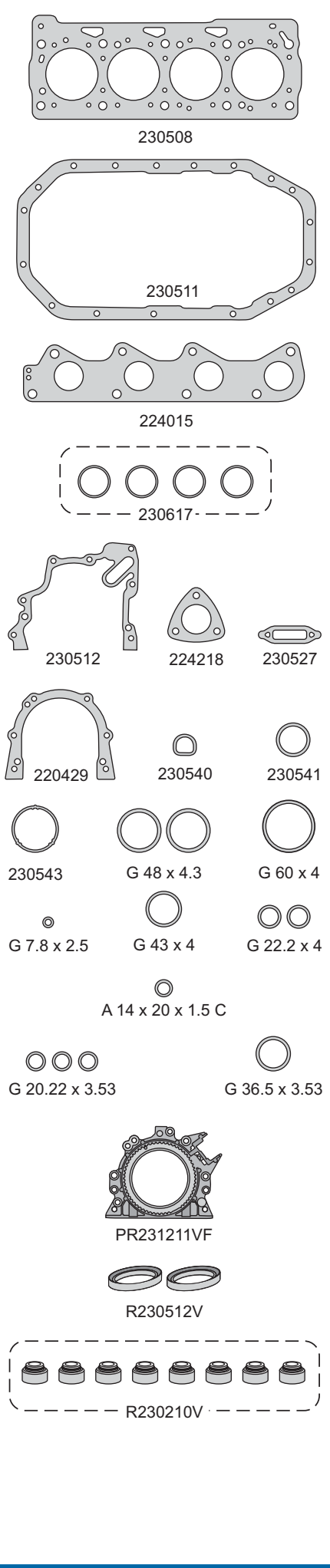

VOLKSWAGEN / AUDI

VOLKSWAGEN



Motor/Engine	Cm³	HP	Ø
AT (DOHC) 16V	999		67.08

Volkswagen: Gol - Power 2002/...



Nº OE	Descripción/Description	Mat.	Ref.
	Jgo. de juntas para motor		● 231300-R MLS
	Jgo. de juntas superior (MLS)	●	231395 MLS
036/103383/M	Junta tapa cilindros Ø 68 ± 0.40 N.R.	MLS 1 1	230508
	Jgo. de tornillos JTC (HAN12055/HAN12100)		B230500
	Junta para cárter	CG 1	230511
032/103161/C	Tapa distribución	SLS 1	230512
036/253039/C	Múltiple escape	AC 1 1	230515
	Jgo. anillo admisión G 46 x 50 x 4.8 (4)	GS 1 1	230517
	Salida de escape	FCH 1 1	224218
036/115111//	Brida bomba aceite	SLS 1	230527
026/103181/B	Bancada trasera	NB 1	220429
	Guarnición goma	GS 2 2	223630
036/103677	Guarnición sellado deflector	GS 1	230540
032/121665/A	Anillo caño bomba de agua	GS 1	230541
	Guarnición goma	GS 1	230543
	O´ring G 60 x 4	GS 1	
	O´ring G 48 x 4.3	GS 2	
	O´ring G 7.8 x 2.5	GS 1	
	O´ring G 22.2 x 4	GS 2	
	O´ring G 36.5 x 3.53	GS 1	
	O´ring G 43 x 4	GS 1	
N/013849/2/	Arandela tapón cárter A 14 x 20 x 1.5 C	CU 1	
	Kit de retenes completo		R231300
036/109675//	Jgo. retén válvulas (16)	V 1	R230510V
068/103171/F	Porta retén bancada trasero	T	PR231211T
	Retén distribución 32 x 42 x 7	V 1	R230512V
036/103085/A	Retén comando válvulas 27 x 42 x 8	V 1	R231313V

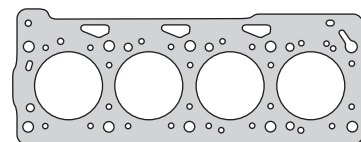

230508

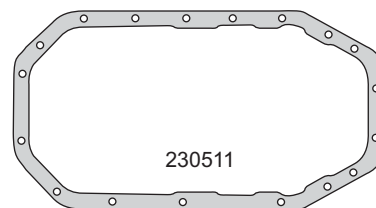

230511

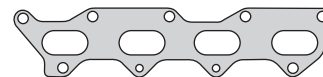

230515



230517

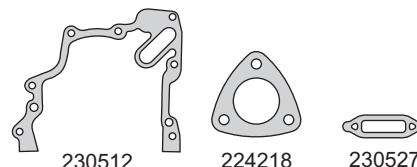

230512

224218

230527

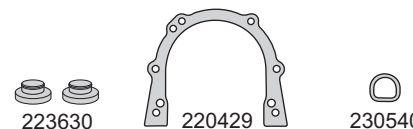

223630

220429

230540



230541

230543

G 43 x 4

G 60 x 4



G 48 x 4.3

G 36.5 x 3.53

G 22.2 x 4



A 14 x 20 x 1.5 C

G 7.8 x 2.5

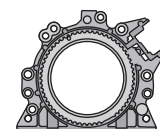

PR2301211T



R230512V



R231313V

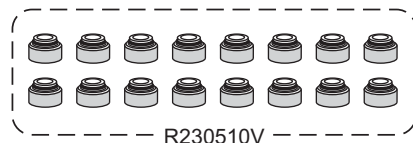

R230510V

VOLKSWAGEN / AUDI

VOLKSWAGEN



Motor/Engine	Cm³	HP	Ø
L5 BGP/BGQ	2480	148/168	82.5

Volkswagen: Bora - Vento 2005/09

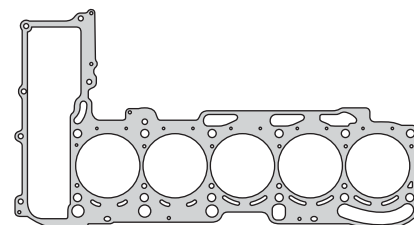

231408

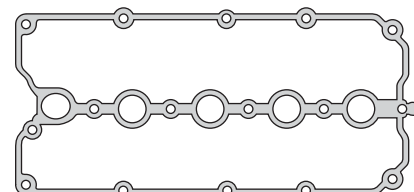

231410



231415



231417-



231418



231430



231431



231433



231434



231435



R220411V

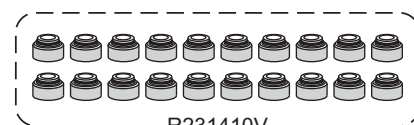

R231410V

Nº OE	Descripción/Description	Mat.	Ref.
	Jgo. de juntas para motor		● 231400-R MLS
	Jgo. de juntas superior (MLS)	●	231495 MLS
	Junta tapa cilindros Ø 83 \pm 0.60	MLS	1 1 231408
	Junta tapa válvulas	GS	1 1 231410
	Múltiple escape	AC	1 1 231415
	Jgo. múltiple admisión (5)	GS	1 1 231417
	Salida de escape	AC	1 1 231418
	Junta	GS	1 1 231430
	Junta	GS	1 1 231431
	Junta	GS	1 1 231432
	Junta	GS	1 1 231433
	Junta	GS	1 1 231434
	Junta	GS	1 1 231435
	Kit de retenes completo		R231400
	Jgo. retén válvulas (20)	V	1 R231410V
	Retén de bancada 85 x 105 x 12	V	1 R220411V

VOLKSWAGEN / AUDI

VOLKSWAGEN



Motor/Engine	Cm³	HP	Ø
L5 AET/APL/AVT	2461	115	81

Volkswagen: Eurovan 2001/04



Nº OE	Descripción/Description	Mat.	Ref.
	Jgo. de juntas para motor		231500-R
	Jgo. de juntas superior	●	231595
023103383B	Junta tapa cilindros Ø 83 ± 1.60	NFT 1 1	231507
	Jgo. de tornillos JTC (HAN12055/HAN12100)		B221100
	Junta tapa válvulas	P 1 1	221110
074.103.609H	Junta para cárter	NFT 1 1	221111
	Frente motor - filtro aceite	NB 1 1	221112
	Frente motor	NB 1 1	230113
	Frente motor - filtro aceite	SLS 1 1	221113
028.129.589B	Jgo. múltiple escape (5)	FCH 1 1	221115
	Arandela pico inyector	AC 5 5	230922
	Jta. acople bomba aceite	NB 1 1	221127
	Jta. chupador bomba aceite	NB 1 1	221129
	Jta. bancada delantera	NB 1 1	220429
	Guarnición salida aceite	N 1 1	221130
	Anillo tapa de válvulas	GS 4 4	230230
	Casquillo árbol de levas	GS 4 4	230231
934.129.717P	Múltiple admisión	NFT 1 1	222838
	Arandela A 8 x 13 x 2.5 C	CU 8 8	
	Arandela blindada B 28 x 34 x 3 CN	CN 2 2	
	O´ring G 23.47 x 2.62	GS 1 1	
	O´ring G 26.64 x 2.62	GS 1 1	
	O´ring G 28.24 x 2.62	GS 1 1	
	O´ring G 34.52 x 3.53	GS 2 2	
	O´ring G 45 x 3	GS 1 1	
	O´ring G 58 x 2	GS 1 1	
	O´ring G 59.92 x 3.53	GS 1 1	
	O´ring G 64.77 x 2.62	GS 1 1	
	O´ring G 98.02 x 3.53	GS 1 1	
	Kit de retenes completo		R221100
026.209.675	Jgo. retén válvulas (10)	P 1 1	R22110P
068.103.051P	Retén bancada 85 x 105 x 12	V 1 1	R220411V
069.115.147E	Retén árbol de levas 35 x 48 x 7	V 1 1	R240013V
068.103.085E	Retén árbol de levas 32 x 47 x 10	V 2 2	R230113V

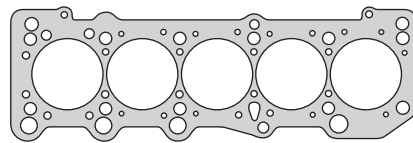

231507

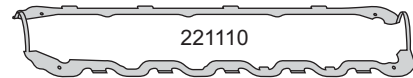

221110

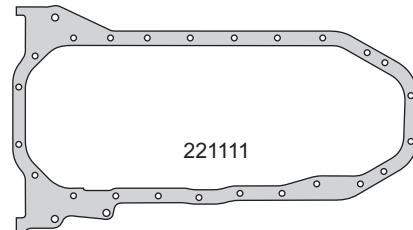

221111

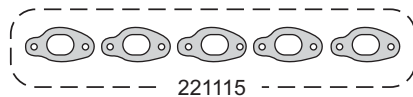

221115

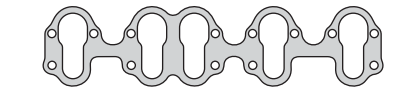

222838

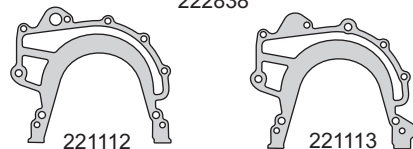

221112

221113



230113

230922

221127



221129

220429

221130



230231

230230



G 45 x 3

G 26.64 x 2.62

G 58 x 2

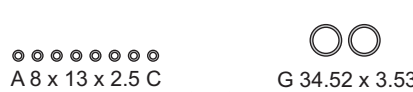

A 8 x 13 x 2.5 C

G 34.52 x 3.53

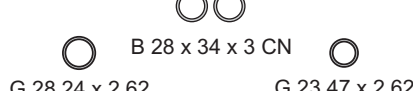

B 28 x 34 x 3 CN

G 28.24 x 2.62

G 23.47 x 2.62



G 98.02 x 3.53

G 59.92 x 3.53

G 64.77 x 2.62



R220411V



R240013V

R230113V



R22110P

VOLKSWAGEN/AUDI

VOLKSWAGEN



Motor/Engine	Cm³	HP	Ø
L4 F.I.	1800	90	81

Volkswagen: Golf - Jetta - Combi Panel 1992/99
(Motores Fuel Injection con sello para válvula de 7 mm)



Nº OE	Descripción/Description	Mat.	Ref.
	Jgo. de juntas para motor		231600-R
026103383	Junta tapa cilindros Ø 82.2 ± 1.70	NFT	1 220605
026103383	Junta tapa cilindros Ø 82.2 ± 1.70	NFT	220607
	Jgo. tornillos tapa cil. (HAN12055/HAN12100)		B220400
056103483C	Conjunto juntas tapa válvulas (3)	CG	1 220410
0491036091	Junta para cárter	NFT	1 220611
056103609A	Brida termostato	NB	1 230113
049121041B	Bomba de agua	NB	1 220614
028/129589/B	Jgo. múltiple escape (4)	FCH	1 230215
056129717	Múltiple admisión	NB	1 220417
	Múltiple admisión	NFT	1 221417
	Salida de escape	NFT	1 230218
841253115B	Salida de escape	FCH	1 220418
056121139A	Entrada agua	NB	1 220419
056115441	Base filtro aceite	NB	1 220427
028/115441/C	Base filtro aceite	NB	1 230227
059127311A	Junta base bomba nafta	NB	2 220628
056103181	Bancada trasera	NB	1 220429
056103161	Bancada delantera	NB	1 220430
029/15189/1	Bomba aceite a block	NB	2 220431
056121149	Junta Termostato	NB	1 220434
056103491	Junta cierre tapa cilindros	GS	1 220437
056103489A	Cuello tapa válvulas superior	GS	1 220440
547253115A	Salida escape Orion	NFT	1 220642
	Arandela A 10 x 14 x 1 A	AL	1
	Arandela A 14 x 20 x 1.5 A	AL	1
	O´ring G 34.2 x 2.5	GS	1
	O´ring G 34.52 x 3.53	GS	1
	O´ring G 50 x 4	GS	2
	O´ring G 56.87 x 1.78	GS	1
	Kit de retenes completo		R231600
027/109675	Jgo. retén válvulas (8)	V	1 R230210V
	Retén bancada 85 x 105 x 12	P	1 R220411P
026/103085/E	Retén distribución y árbol levas 32 x 47 x 10	P	3 R230113P

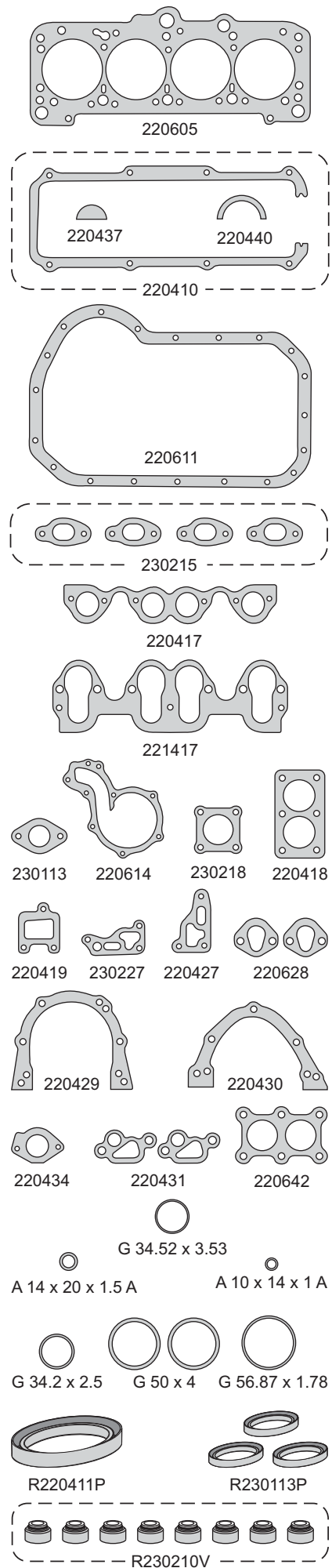

VOLKSWAGEN / AUDI

VOLKSWAGEN



Motor/Engine	Cm³	HP	Ø
CDBA/CDCA Inyección Directa	1968	140/180	81

Volkswagen: Pick Up Amarok TDI 2010/...
Common Rail

DIESEL



Nº OE	Descripción/Description	Mat.	Ref.
	Jgo. de juntas para motor		232401-R
	Jgo. de juntas superior (MLS)		232495-1M MLS
	Jgo. de juntas superior (MLS)		232495-2M MLS
	Jgo. de juntas superior (MLS)		232495-3M MLS
03L103383A	Junta tapa cilindros Ø 82 \geq 1.55	MLS	1 232408-1M
	Junta tapa cilindros Ø 82 \geq 1.63	MLS	232408-2M
	Junta tapa cilindros Ø 82 \geq 1.71	MLS	232408-3M
WHT002131	Jgo. de tornillos para tapa de cilindros		B232400
	Sellado líquido - caucho de silicona		TRN0280R
03L103483C	Conj. junta tapa válvulas (15)	GS	1 232410
038121119	O´ring bomba de agua G 57 x 4	GS	1 232414
03L253039E	Múltiple escape - CDDBA	AC	1 1 232415
03L253039G	Múltiple escape - CDCA	AC	1 1 232415-1
03L129717O	Guarnición admisión	GS	1 1 232417
	Salida de escape	AC	1 1 232418
038121688B	Junta codo agua G 50.39 x 3.53	GS	1 232428
06B121119B	Junta codo agua a block	GS	1 232429
03L103070	Anillo cierre inyectores	GS	4 4 R232430P
	Arandela carga de aceite	GS	1 232433
	Buje tapa válvulas	GS	2 2 232440
	Arandela tapa válvulas chica	GS	6 6 232441
	Arandela tapa válvulas grande	GS	2 2 232442
	Kit de retenes completo		R232400
036109675A	Jgo. retén válvulas (16)	V	1 R230510V
03L103171	Porta retén bancada	T	PR232411T
038103085E	Retén bomba de aceite 35 x 48 x 7	V	1 R240013V
03L103085	Retén de árbol de levas 32 x 47 x 10	V	1 R230113V

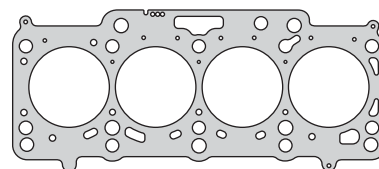

232408

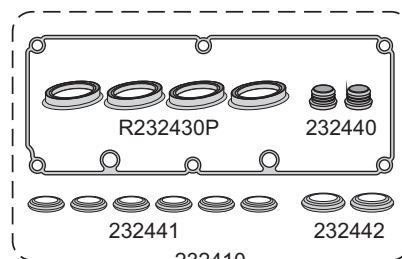

232415



232415-1



232417



232414

232418

232428



232429

232433

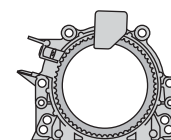

PR232411T



R240013V



R230113V

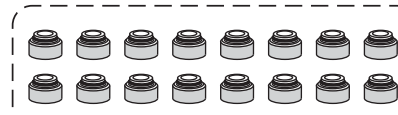

R230510V

VOLKSWAGEN / AUDI

VOLKSWAGEN



Motor/Engine	Cm³	HP	Ø
EA111 (SOHC) 8V	1390	83	76.5

Volkswagen: Gol Power



Nº OE	Descripción/Description	Mat.	Ref.
	Jgo. de juntas para motor		232600-R MLS
	Junta tapa cilindros Ø 78 \pm 0.40	MLS 1	224008
032.103383.N	Jgo. tornillos tapa cilin. (HAN12055/HAN12100)		B224000
	Sellador líquido - caucho de silicona		TRN0280R
	Junta tapa válvulas	NB 1	224010
	Junta para cárter	CG 1	230511
032.103601.AA	Junta distribución	SLS 1	230512
030.121043.C	Múltiple escape	AC 1	224015
	Jgo. anillo admisión G 46 x 50 x 4.8 (4)	GS 1	230517
030.253039.K	Jgo. anillo admisión G 36.3 x 40.8 x 5.4 (4)	GS 1	230617
	Salida de escape	FCH 1	224218
030.121005	Junta subida bomba aceite	SLS 1	230527
026.103181.B	Bancada trasera	NB 1	220429
036.115111	Anillo mezcla a admisión G 64 x 69 x 5	GS 1	224031
032.121665.A	O'ring asiento deflector G 60 x 4	GS 1	224035
N.906175.01	O'ring cierre termostato G 47 x 4	GS 2	224036
032.121119.5	O'ring salida termostato a block G 30.8 x 3.7	GS 1	224037
032/121665/A	Anillo caño bomba de agua	GS 1	230541
035.906149.A	O'ring pico inyector G 7.52 x 3.53	GS 8	224043
N.908560.01	Arandela tapón cárter A 14 x 20 x 1.5 A	AL 1	
1H0.121687.A	O'ring llenado de agua G 28.17 x 3.53	GS 1	
032.121666	O'ring caño unión bomba G 36.09 x 3.53	GS 1	
N.907653.01	O'ring acople retorno radiador G 32 x 4	GS 2	
	Arandela A 14 x 20 x 1.5 C	CU 1	
	Kit de retenes completo		R224000
036.109675	Jgo. retén válvulas (8)	V 1	R224010V
030.103170	Porta retén bancada trasero	T	PR224011T
036.103085.E	Retén árbol de levas 32 x 42 x 7	V 1	R230512V
036.103085.G	Retén bomba de aceite 32 x 42 x 7	V 1	R230512V

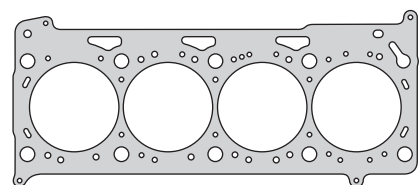

224008

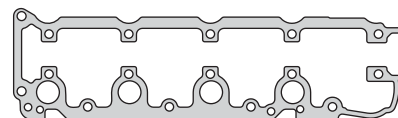

224010

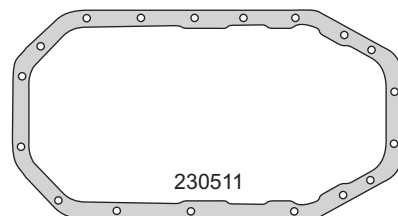

230511



224015



230517



230617

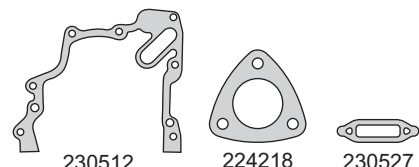

230512

224218

230527

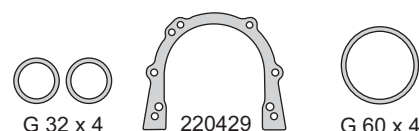

G 32 x 4

220429

G 60 x 4



230541

G 64 x 69 x 5

G 36.09 x 3.53

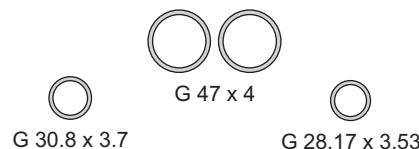

G 47 x 4

G 30.8 x 3.7

G 28.17 x 3.53



G 7.52 x 3.53

A 14 x 20 x 1.5 A

A 14 x 20 x 1.5 C

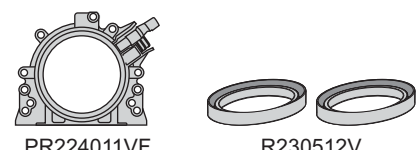

PR224011VF

R230512V



R224010V

VOLKSWAGEN



Motor/Engine Cm³ HP Ø

AP 8V 1984 107/115 82.5

Volkswagen: Santana 1998/...



Nº OE	Descripción/Description	Mat.			Ref.
	Jgo. de juntas para motor				233000-R
	Jgo. de juntas superior		●	●	233095
053103383	Jta. tapa cilindros Ø 83.5 \pm 1.70	NFT	1	1	230007
	Jgo. de tornillos JTC (HAN12055/HAN12100)				B220400
0261034832	Junta tapa válvulas superior (goma/metal)	N	1	1	230310
044103609D	Junta para cárter (goma/metal)	ACP	1	1	230311
049121041B	Bomba de agua	NB	1	1	220614
056129589	Jgo. múltiple escape (4)	FCH	1	1	230215
	Múltiple admisión	NFT	1	1	230317
325/253137	Catalizador	CAC			230318
841253115B	Salida de escape	FCH	1	1	220418
547/253115/A	Salida caño de escape	FCH			220618
056121139A	Entrada agua	NB			220419
	Base filtro aceite	NB		1	230227
056115441	Base filtro aceite	NB		1	220427
056103181	Bancada trasera	NB		1	220429
056188161	Bancada delantera	NB		1	220430
056905261	Base distribuidor	CB		1	220433
659/127311/A	O'ring salida t/cil. a calefactor G 34.52 x 3.53	GS	2	2	220639
	O'ring porta retén distribución G 56.87 x 1.78	GS		1	220442
	Salida de escape	NFT		1	220642
	Catalizador gases	FCH		1	220644
059/121119/	O'ring termostato G 50 x 4	GS		2	
	O'ring G 36.17 x 2.62	GS		1	
029/103608/1	Arandela cárter A 14 x 20 x 1 C	CU	1	1	
	Arandela A 22 x 26 x 1 C	CU		1	
	Arandela A 10 x 14 x 1 C	CU		1	
	Kit de retenes completo				R230300
	Jgo. retén válvulas Ø7 mm. (8)	V		1	R230210V
048/10305/	Retén bancada 85 x 105 x 12	V		1	R220411V
026/103085/E	Retén distrib. y árbol levas 32 x 47 x 10	P		3	R230113P

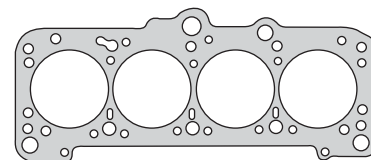

230007

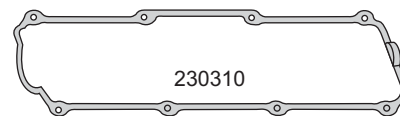

230310

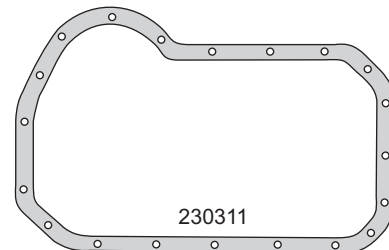

230311

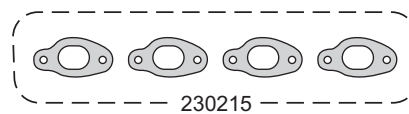

230215



230317



220614

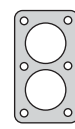

220418



220618



220419



220427



230227



220433



220429

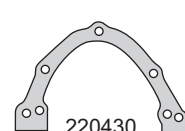

220430

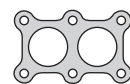

220442



220644



G 50 x 4



G 34.52 x 3.53



G 56.87 x 1.78

G 36.17 x 2.62

A 14 x 20 x 1 C

A 22 x 26 x 1 C

A 10 x 14 x 1 C



R220411V



R230113P



R230210V

VOLKSWAGEN / AUDI

VOLKSWAGEN



Motor/Engine	Cm³	HP	Ø
CHYA/CHYB (DOHC) 16V	1598	60/75	74.5

Seat: Mii 2011/...
 Skoda: Citigo 2011/...
 Volkswagen: UP 2011/...



Nº OE	Descripción/Description	Mat.	Ref.
	Jgo. de juntas para motor		● 233100-R MLS
04C103383N	Junta tapa cilindros Ø 75.5 ± 0.30	MLS	233108
WHT007089	Jgo. de tornillos para tapa de cilindros		B233100
	Sellador líquido - caucho de silicona		TRN0280R
04C103483E	Junta tapa válvulas	SLS	1 233110
04C103161E	Tapa distribución	SLS	1 233412
04C129717C	Jgo. múltiple admisión (4)	GS	1 233117
04E121119	Bomba de agua	GS	1 233114
1S0253115B	Salida de escape	AC	1 233418
04C133073B	Junta TBI	GS	1 233132
	Kit de retenes completo		R233100
04E109675/A	Jgo. retén válvulas (12)	P	1 R233110P
04C103170K	Porta retén bancada	P	1 PR233111P
04C103085B	Retén distribución 30 x 40 x 7	P	1 R233112P
04E103085AF	Retén árbol de levas 36 x 46 x 7	P	2 R233113P
04E103085	Retén bomba de agua 24 x 39 x 8	P	1 R233115P

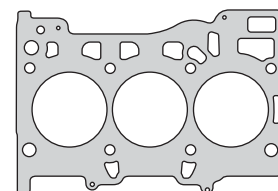

233108

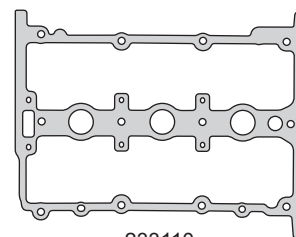

233110



233117



233132

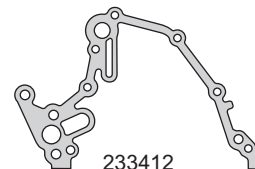

233412



233114

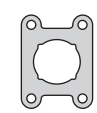

233418

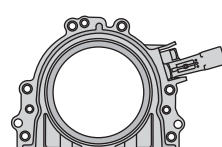

PR233111P



R233112P

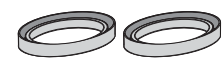

R233113P



R233115P

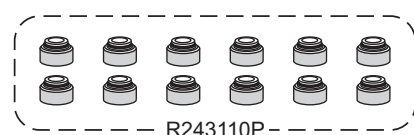

R243110P

VOLKSWAGEN / AUDI

VOLKSWAGEN



Motor/Engine	Cm³	HP	Ø
CDAI/CDAB	1798	152/160	82.5
CDNB/CDNC	1984	170/211	82.5
CAEB/CBFA			
CAEA/CCTA (DOHC) 16V			

Audi: A3/Q5 TFSI 2008/... - A4/A5 2010/...
Seat: Altea - Leon - Toledo TSI 2009/10
Skoda: Octavia - SuperB - Yeti 2009/...
Volkswagen: Passat TSI - Golf FSI - Tiguan FSI
 Eos FSI - Passat FSI 2007/...
 Scirocco FSI 2008/...



Nº OE	Descripción/Description	Mat.	Ref.
	Jgo. de juntas para motor		● 233200-R MLS
	Junta tapa cilindros Ø 83 ± 0.90	MLS	233208
	Sellador líquido - caucho de silicona		TRN0280R
06F253039F	Múltiple escape	AC	1 233215
06F129717D	Múltiple admisión	GS	1 233217
1K0253115AB	Salida de escape	AC	1 233218
06H1211190	Bomba de agua	GS	1 233219
06J117070C	Junta enfriador aceite	GS	1 233227
06H103517D	Junta separador de aceite	GS	1 233228
06H103121F	Bomba vacío	GS	1 233229
	Guarnición goma	GS	1 233233
06J115441A	Sello soporte a block	GS	1 233234
06H103484A	Junta válvula control de presión (PCU)	GS	1 233237
	Kit de retenes completo		R233200
	Jgo. retén válvulas (16)	P	1 R233210P
06H103171A/F	Porta retén bancada	P	1 PR233211P
06H103085G	Retén distribución 45 x 60 x 8	P	1 R233212P

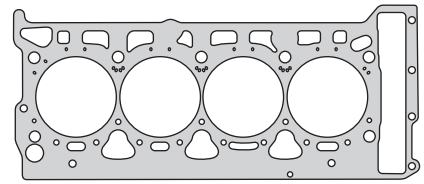

233208

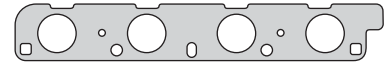

233215



233217



233218

233219

233229

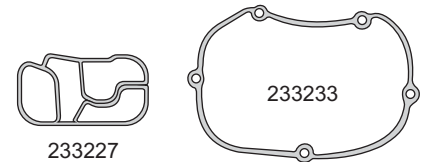

233227

233233



233228

233234

233237

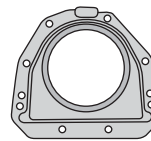

R233211P



R233212P

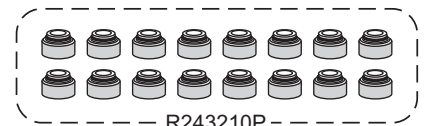

R243210P

VOLKSWAGEN / AUDI

VOLKSWAGEN



Motor/Engine **Cm³** **HP** **Ø**

**BAG/BLP/BLF
BTS**
(DOHC) 16V

1598

105/115

76.5

Audi: A3 FSI 2003/...
Skoda: Octavia 2004/...
Volkswagen: Golf FSI - Touran FSI - Passat FSI
Jetta FSI 2005/... - Eos FSI - Polo
Crosspolo 2006/...

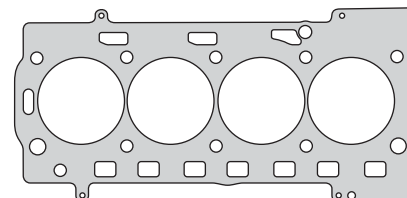

233308



233315

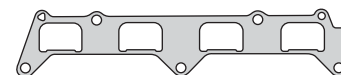

233317



233317-1

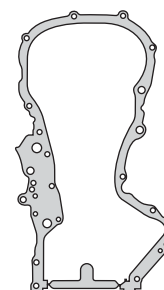

233312

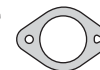

233318



233345



G 45 x 5.5



G 64 x 5.2

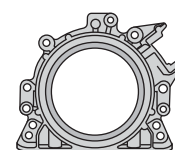

PR233311P



R233312P



R230113P



R243310P

Nº OE	Descripción/Description	Mat.	Ref.
	Jgo. de juntas para motor		● 233300-R MLS
	Junta tapa cilindros Ø 77.5	MLS	233308
	Jgo. de tornillos para tapa de cilindros		B231700
	Sellador líquido - caucho de silicona		TRN0280R
	Tapa distribución	GS/AC	1 233312
	Múltiple escape	AC	1 233315
	Múltiple admisión	NFT	1 233317
	Jgo. múltiple admisión (4)	GS	1 233317-1
	Salida de escape	AC	1 233318
	Salida de escape a turbo	AC	1 233345
	O´ring G 45 x 5.5	GS	4
	O´ring G 64 x 5.2	GS	1
	Kit de retenes completo		R233300
	Jgo. retén válvulas (16)	P	1 R233310P
	Porta retén bancada	P	1 PR233311P
	Retén distribución 35 x 48 x 10	P	1 R233312P
	Retén árbol de levas 32 x 47 x 10	P	2 R230113P

VOLKSWAGEN



Motor/Engine	Cm³	HP	Ø
EA211 (DOHC) 16V	1598	110	76.5

Volkswagen: Suran - Suran Cross - Saveiro
 Novo Fox - Gol Rallye
 Saveiro Cross 2015/...



Nº OE	Descripción/Description	Mat.	Ref.
	Jgo. de juntas para motor		● 233400-R MLS
04E103383BE	Junta tapa cilindros Ø 77 ± 0.40	MLS	233408
WHT007089	Jgo. de tornillos para tapa de cilindros		B233400
	Sellador líquido - caucho de silicona		TRN0280R
04E103483N	Junta tapa válvulas	SLS	1 233410
04C103161E	Tapa distribución	SLS	1 233412
04C129717D	Jgo. múltiple admisión (5)	GS	1 233417
04E121119P	Bomba de agua	GS	1 233414
1S0253115B	Salida de escape	AC	1 233418
03C133073D	Junta TBI	GS	1 233432
	Kit de retenes completo		R233400
04E109675/A	Jgo. retén válvulas (16)	P	1 R233410P
04C103170K	Porta retén bancada	P	1 PR233111P
04C103085B	Retén distribución 30 x 40 x 7	P	1 R233112P
04E103085AF	Retén árbol de levas 36 x 46 x 7	P	2 R233113P
04E103085	Retén bomba de agua 24 x 39 x 8	P	1 R233115P

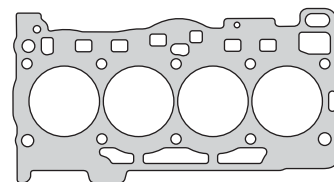

233408

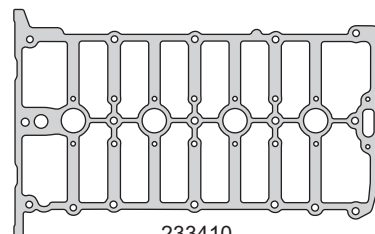

233410

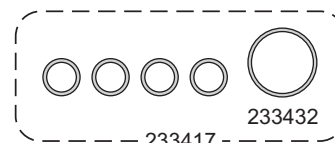

233417

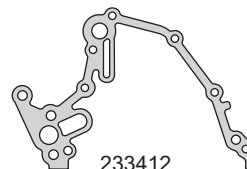

233412



233414



233418

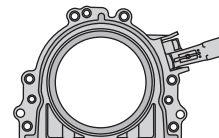

PR233111P



R233112P



R233113P



R233115P

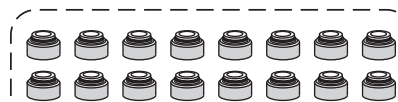

R233410P

VOLKSWAGEN/AUDI

WILLYS



Motor/Engine	Cm³	HP	Ø
CJ2A-CJ3A DJ3A	2199	52	79.38

Willys: Jeep - CPW Universal
Rastrojero - 4 - 63
2WD - 4WD 1940/74



Nº OE	Descripción/Description	Mat.	Ref.
	Jgo. de juntas para motor		540900
989	Junta tapa cilindros Ø 80.5 ± 1.90	FCH	1 540905
630305	Junta tapa válvulas	CG	1 540910
639980	Junta para cárter	CG	1 540911
630365	Tapa distribución	CG	1 540912
630359	Placa distribución	NB	1 540913
637053	Cuerpo bomba de agua	NB	1 540914
634812	Múltiple admisión y escape	NFT	1 540916
	Entre múltiples	NFT	1 540917
634814	Salida de escape	NFT	1 540918
637016	Salida caño agua	NB	1 540919
630890	Base carburador	NB	1 540925
	Base bomba aceite	NB	1 540927
	Base bomba nafta	NB	1 540928
115656	Vaso bomba nafta	CG	1 540929
637790	Cierre bancada	CB	540930
639650	Entrada caño agua	NB	1 540931
637237	Jgo. empaquetadura cigüeñal (2)	SNA	1 540958
	Retén distribución 44.45 x 61.95 x 9.52	N	R540912N

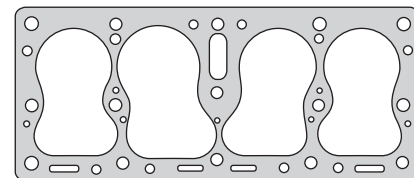

540905

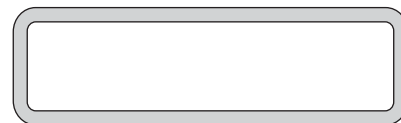

540910

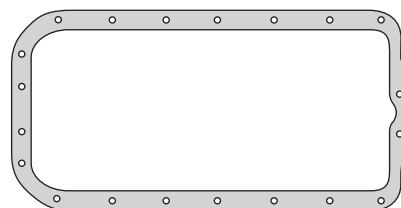

540911



540916

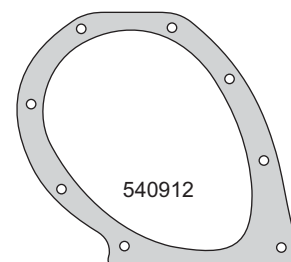

540912

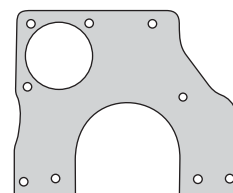

540913



540914

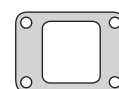

540917



540918



540919



540925



540927



540928

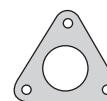

540931



540929



540930

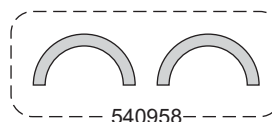

540958



R540912N

