

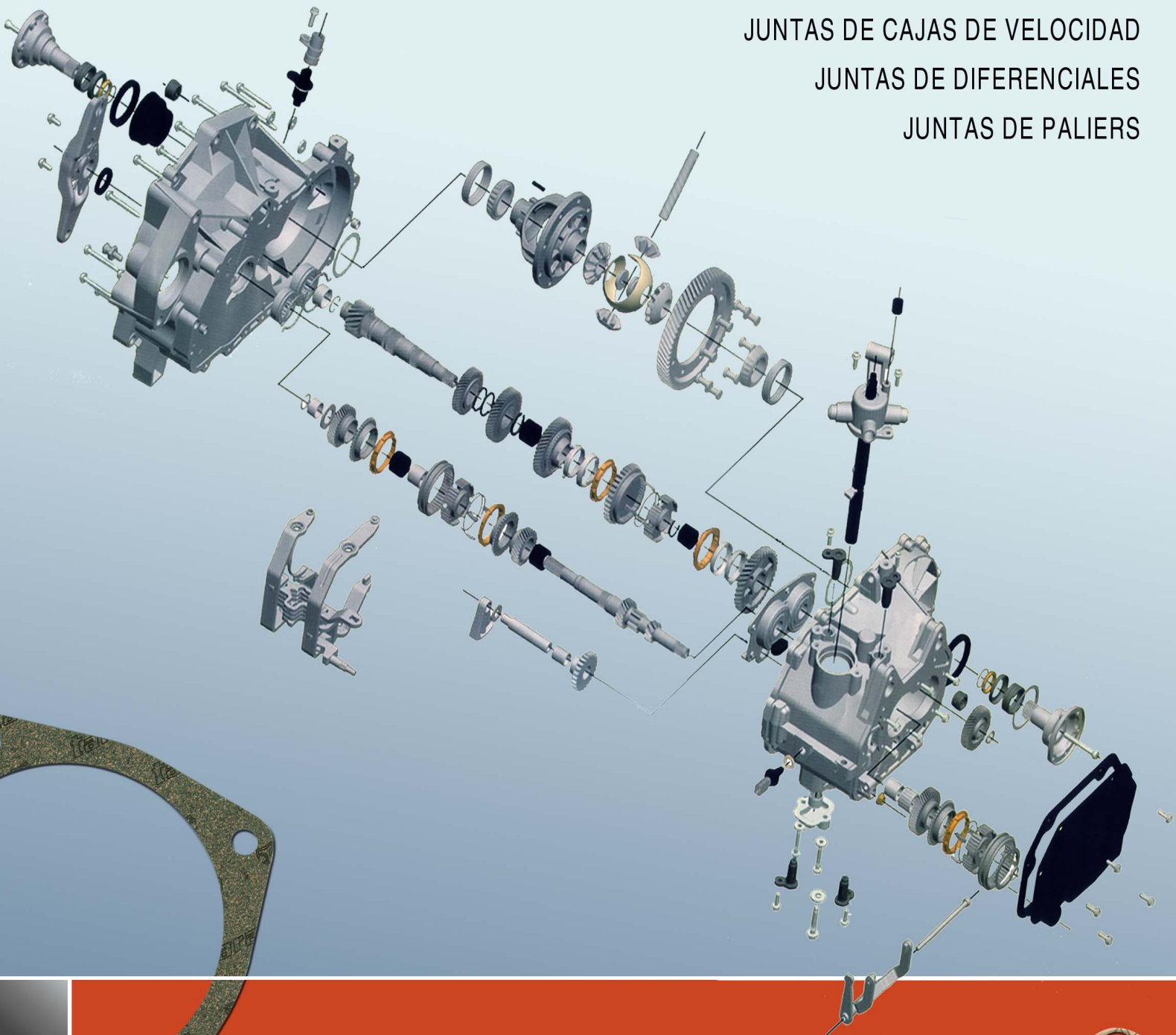

taranto

JUNTAS DE CAJAS DE VELOCIDAD
JUNTAS DE DIFERENCIALES
JUNTAS DE PALIERS



CATALOGO 2013



Juegos de Juntas para Cajas de Velocidad

Borgward

Codigo	Descripcion	Pag.
500050	Rastrojero 1957/71 - Caja Borgward 42/52HP	11

Chevrolet - Opel

Codigo	Descripcion	Pag.
200050	400 - Pick Up - Hasta 1963	1
200051	400 - Super Pick Up - 2da Serie FAE - 1ra Sincro.	1
200151	Chevy - Coupe S y SS - 4 Vel. Saginaw 1972/75	1
200250	K180 - Chevette 1973/... - Clack 4/5 - FAE 1975/...	1
210150	Camion 350 - 475 Caja de 5ª FAE	1
220151	400, Pick Up, Hasta 1963 - Caja Automatica BW-45	3
240050	Monza 1.6, 1.8, 2.0 - Caja Clark - 4/5 Velocidades	4
240450	Corsa, Combo, Astra 1.4, 1.6 Todos - 5 Vel.	4
310550	A60/D60 1985/91 - Eaton Manual Caja 450 - 5 Vel.	8

Chrysler - Dodge

Codigo	Descripcion	Pag.
210150	DP 800 - 475 Caja de 5ª FAE	1
210350	D100/400 - DP400 1963/65 - P432 Naf y Gasolero	1
220050	Valiant I y II - Pick Up - Desoto Pick Up 1951/61	2
220051	Valiant III y IV - Pick Up - Desoto Pick Up D100/200	2
220052	Coronado 4V - GTX - Polara - Caja Mexicana 4 Vel.	2
220053	Polara - 3 Velocidades	2
220150	1500 Todos - 4 Velocidades	2
220950	DD1000 Todos	3
710150	DD1000	14

Dacia

Codigo	Descripcion	Pag.
560250	1310 - 1410 TXL 1992/...	13

Daihatsu

Codigo	Descripcion	Pag.
950050	Max Coure - Wide Cab - Cab Van 1980/... AB 20/30 547cc.	17

Deutz

Codigo	Descripcion	Pag.
650850	Omnibus OA 101 - Eaton Man Modelo 405-413N	13

Di Tella

Codigo	Descripcion	Pag.
210950	1500 - 1650	2

Fiat

Codigo	Descripcion	Pag.
220950	673 Todos	3
250050	1100 - 4 Velocidades	4
250150	600, 600 E.D.F.R., 750, 880 - 4 Velocidades	5
250250	1300, 1500, 1600, 125 - 1ra Serie - 4 Velocidades	5
250450	127, 128, 1100, 1300, Sport, Torino, Ritmo 60 Hasta 1977 - 4 Velocidades	5
250451	128, 1110, 1300 Hasta 1977 - 4 Velocidades	5
250550	128, 1100, 1500, Europa, Super Europa, Ritmo 60 Caja de 4ta y de 5ta.	5
250551	128, 1100, 1500, Europa, Super Europa - Caja 4 y 5	5
250850	133, 600S - 4 Velocidades	6
260250	Ducato 1.7/1.9 Nafta - 2.5/2.8 D/TD Caja Nac. 5 Vel.	6
270050	Ducato 1.7/1.9 Nafta - 2.5/2.8 D/TD 4 Velocidades	6

Fiat Tractor / Camion

Codigo	Descripcion	Pag.
700950	411R - Tractor	13

Fiat Tractor / Camion

Codigo	Descripcion	Pag.
710150	673	14
800050	619N1 - Caja T90	14
800051	619N1 - Caja Fuller K2199	14
800350	Camión 150 Turbo - Caja Eaton FS 5005 - FS 5205	14
800351	Iveco Eurocargo 135/150/170 E23 - G205 Caja FAE 475/GRS	15
800550	Iveco Eurotracker - 240/260 Motor 8010.42	15

Ford

Codigo	Descripcion	Pag.
210150	F700 - 475 Caja de 5ª FAE	1
300050	Falcon 1964/68 - Caja FAE - 3 Velocidades	6
300051	F100 - Fairlane 1966/77 - Caja 303 1ra Sinc. - 3 Vel.	6
300052	Falcon - 4 Velocidades Transax 325	6
300250	F100 1962/63 - Importado - 3 Velocidades	7
300251	F350/600 1960/67 y 1956/64 - Caja Clark 450B-T98	7
300350	Taurus 2.0/2.3 - Sierra 2.3 4 Velocidades	7
300450	Taurus - Sierra - 5 Velocidades	7
300750	Ford 1.3/1.5 - Escort GL - GS - Ka - Fiesta - Orion 1995/...5 Velocidades	7
300950	Falcon - Importado - 3 Velocidades	7
310053	F100 - 5ta. Hummer Naftera 1990	8
310450	F100 - F1000 - Motor MWM Diesel 1992 Caja Clarck 5 Velocidades	8
310550	F2000 - F11000 - F14000 - Motor MWM 1992/... Eaton Manual - Caja 450 - 5 Velocidades	8
310551	T75 - 7153 A MWM - F - Ford 14000	8
870050	F100/4000 - Caja ZF S5 - 420 - 5 Velocidades	18
870250	Ford Cargo - 1722 - Eaton FS - 6306 A - 6 Velocidades - 1996	18
870251	Ford Cummins - Caja Eaton FS - S205 A - 5 Vel.	18

Ika

Codigo	Descripcion	Pag.
540050	Jeep - Bergantin - Estanciera - Gladiador T80 54/67 Traccion simple 4 cilindros - 4L151 - 6 cilin. 6L226	11
540051	Baqueano 500/1000, Estanciera, Gladiador T80 - Jeep Utilitario Traccion Doble 4 cilindros 4L151 - 6 cilindros 6L226	12
540350	Torino 7B - Caja ZF - 4 Velocidades	12

Indenor

Codigo	Descripcion	Pag.
500250	Rastrojero XDP 4.88 - Motor Indenor	11

John Deere

Codigo	Descripcion	Pag.
850150	Tractor - Equipos Viales - Moto Niveladora - Todos 1420/2320/2420/2530/3530/4420/4530/750A320/570	16
850450	Tractores 3350/3140/3550 2000/... 2da. Serie 4 Vel.	17

Lada

Codigo	Descripcion	Pag.
250250	Niva 2121 - 1ra Serie - 4 Velocidades	5

Massey Ferguson

Codigo	Descripcion	Pag.
400650	Tractor - Todos - Transmision y mando	10

Mercedes Benz

Codigo	Descripcion	Pag.
350050	3500, 1112, 4500 - Caja G-27	8



Mercedes Benz		
Codigo	Descripcion	Pag.
350050	3500, 1112, 4500 - Caja G-27	8
350150	L608, 710 Caja G-20/G-24	8
350350	1112, 1114 Caja G-32	8
350450	1517, 1518, OH1419 Caja G-60/G-50 5 Velocidades	9
350650	1521, OM355 - Caja GV80	9
350651	1526 - OM355/355A Caja G120-ZF	9
350950	1218 - L1620OKR M366 Caja ZF S5-680	9
360050	OM447/449, G90, G105 - Caja G-90/G-105 6 Vel.	10
360150	180D - OM616 - 4 Velocidades	10
360350	OM366 16S130 - Intercooler LA OM 447/449 1622/1633/1938 - Caja 85130-16S130 - ZF - 8 Vel.	10
360950	Mercedez Benz OHL 1320/1420 OH 1621L / 1721L	

Peugeot		
Codigo	Descripcion	Pag.
450050	404/504 1967/70 - Caja C3B 4 Velocidades	10
450350	404/504 1971/... Caja BA7 4 Velocidades	11
450550	504/505 1983/... - Caja BA7/5 - 5 Velocidades	11
460250	205/306/405 1991/... - Caja BE3/5 - 5 Velocidades	11

Renault		
Codigo	Descripcion	Pag.
550050	Dauphine - Gordini 4L - 4F - S - 3/4 Velocidades	12
550350	R6 - R12 - 4 Velocidades	12
550450	R12 - Caja de 5ta.	12
550650	R18 - Caja de 5ta.	12
550750	R9/11/12/18/19 - Express - Clio- Kangoo	13
550752	R9/11/12/18/19 - Express - Clio- Kangoo	13
560050	Trafic	13

Scania		
Codigo	Descripcion	Pag.
810150	L111/112 - GRS 870/871 - 10 Velocidades	15
810250	K112 Bus - GRS 776 - 5 Velocidades	15
810350	Camion 113/114/124 - GRS 900 - 12 Velocidades	16
810351	Camion 113/114/124 - GRS 900 - 12 Velocidades	16
810352	Camion P93 - P94 Bus K113 - GR 801 - 8 Vel.	16
810353	Camion P93 - P94 - Bus K113 - GR801 - 8 Vel.	16

Seat		
Codigo	Descripcion	Pag.
223550	Ibiza, Cordoba - Caja 250 MQ	4

Volkswagen		
Codigo	Descripcion	Pag.
220150	1500/1800 Todos - 4 Velocidades	2
220350	Kombi, Escarabajo 1.3 - Caja Tipo II 4 Velocidades	3
220450	Gacel, Saveiro, Senda, Gol, Passat 1.8 - 5 Vel.	3
220451	Gacel GL - 4 Velocidades 1ra. Serie 1983/85	3
220452	Gacel - 4 Velocidades 2da. Serie 1985/...	3
223550	New Beetle, Bora, Polo, Golf - Caja MQ250	4
230050	Carat, Galaxy 1996/... - Escort XR3 - Caja 827	4
230051	Pointer - Orion - Escort - Golf - Polo - Caja 827 MQ	4

Juegos de Juntas para Diferencial

Bedford		
Codigo	Descripcion	Pag.
210155	Diferencial Eaton 161/162 - Grande A y B	18
210166	Motor Eléctrico, Cambios Eaton 132/161/162	18

Chevrolet		
Codigo	Descripcion	Pag.
210155	Chevrolet 350 - Dif. Eaton 161/162 - Grande A y B	18
210166	Motor Eléctrico, Cambios Eaton 132/161/162	18
300255	C50 - Diferencial Eaton 132 - Chica A y B	18

Dodge		
Codigo	Descripcion	Pag.
210155	DP600/800 - Dif. Eaton 161/162 - Grande A y B	18
210166	Motor Eléctrico, Cambios Eaton 132/161/162	18
300255	D400/500 - Diferencial Eaton 132 - Chica A y B	18

Ford		
Codigo	Descripcion	Pag.
210155	F700/600 - Diferencial Eaton 161/162 - Grande A y B	18
210166	Motor Eléctrico, Cambios Eaton 132/161/162	18
300255	F600/900 - Diferencial Eaton 132 - Chica A y B	18

Mercedes Benz		
Codigo	Descripcion	Pag.
210155	MB911/1112/1114 - Eaton 161/162 - Grande A y B	18
210166	Motor Eléctrico, Cambios Eaton 132/161/162	18
300255	MB911/4500 - Diferencial Eaton 132 - Chica A y B	18

Peugeot		
Codigo	Descripcion	Pag.
450055	404 1962/67	18
450155	404 - 504 1969/80	18
450555	505	18

Juntas para Diferencial

Borgward		
Codigo	Descripcion	Pag.
500055	Rastrojero	22

Chevrolet - Opel		
Codigo	Descripcion	Pag.
200059	Super , Special, Chevy, C10, 1020, D10 BR - Eaton	19
200067	Super , Special, Chevy, C10, D20 BR - Eaton Nac.	19
200069	Impala	19
200434	Impala	19
240059	Monza 1.6/1.8/2.0	19
240159	Chevette 1.4/1.6 1973/...	19
240259	Monza 1.6/1.8/2.0 (todos)	19
240459	Astra - Corsa 1.0/1.4/1.6	19
300086	Pick Up 1996/... - C14 1967/70 = Dana 44	19
300087	C14 1967/70 = Brasilero Salisbury	20
310459	C20, D20, Silverado, Blazer 1995/97 = Dana 46	20
350368	350D = Eaton A y B	21
350369	350D = Eaton 161/162	21
450355	Pick Up 1970/... - Dana 30 Transax	22
450362	Pick Up 1970/... - Dana 30 Transax	22
540068	Dana 44	22

Chrysler - Dodge		
Codigo	Descripcion	Pag.
200059	100/200 - Eaton Nacional, Autoblocante	19
200067	100/200 - Eaton Nacional, Autoblocante	19
220159	1500	19
350368	DP600/800 - Eaton 132 A y B	21
350369	DP600/800 - Eaton 161/162	21
540034	Dana 44	22
540068	Dana 44	22



Di Tella		
Codigo	Descripcion	Pag.
210959	1500 - Argenta	19

DKW		
Codigo	Descripcion	Pag.
140056	1000 - 1000S	19

Fiat		
Codigo	Descripcion	Pag.
250059	1100	19
250259	125, 1500, 1600 - Eaton Nacional - Autoblocante	19

Fiat Camiones/Tractores		
Codigo	Descripcion	Pag.
320459	Camiones 1970/80 - Brasilerio	20
700951	Tractor 400/500	22
700953	Tractor 400/500	22
700963	Tractor 411R	22

Ford		
Codigo	Descripcion	Pag.
200059	Pick Up, F100 1992 - Eaton Nacional, Autoblocante	19
200067	Pick Up, F100 1992 - Eaton Nacional, Autoblocante	19
300086	F100 = Falcon, Fairlane, = Dana 44	19
300087	F75, F100/1000/2000, Willys = Brasilerio Salisbry	20
300264	F250/350 = Spicer 60/70 = Dana	20
300265	F250/350 = Spicer 70 = Dana	20
300272	F2000/4000 1982/... = Brasilerio	20
300659	Sierra 1.6	20
300835	A = AA	20
310459	F100/1000 = MWM 2294 = Dana 46	20
320159	F100, Pick Up, Ranger	20
320459	F4000 1975/81 = Brasilerio	20
330359	Transit D 4EB = Tipo 34 14"	20
330361	Transit D 4EB = Tipo 51 15"	20
350355	F350/600 = Eaton 132 A y B Alta y Baja (chico)	21
350368	F600/6000 Eaton 132 A y B	21
350369	F600/6000/7000 = Eaton 161/162	21
350388	F350/600 = Eaton 132 A y B (chico)	21
350389	F600 Eaton 161/162	21
450355	Taunus, Falcon 2.3 - Dana 30 Transax	22
450362	Taunus, Falcon 2.3 - Dana 30 Transax	22
540034	Dana 44	22
540068	Torino - Dana 44	22

Ika		
Codigo	Descripcion	Pag.
300086	Dana 44	19
540034	Dana 44	22
540068	Dana 44	22

John Deere		
Codigo	Descripcion	Pag.
850363	3350/3550/3140	23
850364	2730 - Freno Exterior	23
850365	2730 - Freno Interior	23

Lada		
Codigo	Descripcion	Pag.
250059	1600	19

Massey Ferguson		
Codigo	Descripcion	Pag.
400759	165/265	21

Mercedes Benz		
Codigo	Descripcion	Pag.
350059	3500 = 4500 OM311	20
350069	3500 OM312	20
350158	OM314/364 = MB L608D	20
350159	L608D, OM314/364, D710D, 817/917/1017 - Eaton	20
350167	MB - Bandeirantes	20
350255	LPO = 322/321 = MB1111	21
350259	1112/1114/0140 Bus LPO322/1111/B	21
350355	911/1112 = Eaton 132 Alta y Baja (chico)	21
350368	911/1112/1114 - Eaton 132 A y B	21

Mercedes Benz		
Codigo	Descripcion	Pag.
350369	911/1112/1114 = Eaton 161/162	21
350388	1112 = Eaton 132 A y B (chico)	21
350389	1114 = Eaton 161/162	21
350459	1517/6600/1215 = OM352A	21
350467	1517/6600 = OM 352A	21
350486	1114 = Eaton 161/162	21
350487	OH1419, 1314/1318 Bus, OM904, 712/812/817/917	21
350656	OM2213	21
350658	MB1924	21
360156	180D = OM616	21

Peugeot		
Codigo	Descripcion	Pag.
450054	403/404 1962/80	22
450056	403/404/504 1962/67	22
450059	403/404/504 1962/67	22
450062	403/404/504 1962/67	22
450156	404/504 1968/80	22
450159	404/504/505 1967/80	22
450162	404/504/505 1967/80	22
450355	504/506 - Dana 30 Transax	22
450362	504/506 - Dana 30 Transax	22
450556	504/505	22

Scania		
Codigo	Descripcion	Pag.
810159	111/112	23

Volkswagen		
Codigo	Descripcion	Pag.
450355	1.5/1.8 - Dana 30 Transax	22
450362	1.5/1.8 - Dana 30 Transax	22

Juntas para Paliers

Borgward		
Codigo	Descripcion	Pag.
500056	Rastrojero 42HP	25
500156	Rastrojero 52HP	25

Chevrolet		
Codigo	Descripcion	Pag.
210156	350D	23
300256	C50	24
300273	C60 - D60 - D70 - D80 - Tinken	24
300557	350D	24
310457	A60	24

Dodge - Chrysler		
Codigo	Descripcion	Pag.
210156	Dp600	23



Dodge - Chrysler		
Codigo	Descripcion	Pag.
210156	DP600	23
210957	D1500 - Siam Argenta	23
220156	1500 - 1800 Brasil	23
220162	1500 - 1800 Nacional	23
220164	D100 - Eaton	23
220756	D100	23
220757	D200	23
220956	DD1000 - Jeep Cherokee	23
300256	D400/500	24
300557	DP600/800	24

Fiat		
Codigo	Descripcion	Pag.
250154	600/750	23
250256	125 1500/1600	23
250868	133/600S	24

Ford		
Codigo	Descripcion	Pag.
300056	Falcon 188 - 211" 7B	24
300057	Falcon	24

Ford		
Codigo	Descripcion	Pag.
300065	Falcon - Dana 44	24
300069	Falcon - F100	24
300156	F100 1970/82 - Dana, Transax	24
300256	F600/900	24
300273	F600 1957/70 - Tinken	24
300356	Taurus 2.0	24
300556	F350	24

Ford		
Codigo	Descripcion	Pag.
300557	F700/6000	24
300559	F350	24
310456	F4000 - F300/350/400 2000/... MWM 2294cc.	24
310457	F600/700	24
310458	F300/350/400/2000	24
310556	F14000 - MWM 2296cc. Cargo	24
310557	F700/750/8000/13000	25

Ika		
Codigo	Descripcion	Pag.
540056	Jeep - Estanciera - Baqueano	25
540062	Jeep - Estanciera - Baqueano - Rambler	25

Mercedes Benz		
Codigo	Descripcion	Pag.
300256	911/4500	24
300557	1112/1114	24
350256	312/911/3500/608D	25
350257	1112/1114 - Alta y Baja	25
350456	1517 Turbo OM 352A	25
350457	1113/1313/1513/2013	25
350468	1517 Turbo OM 352A	25

Peugeot		
Codigo	Descripcion	Pag.
450057	403/404/504	25
450257	T4B - Pick Up	25
450356	504 - 505 Transax	25

Volkswagen		
Codigo	Descripcion	Pag.
310458	6.80 - 6.90	24

Certificados de Calidad

IQNet
THE INTERNATIONAL CERTIFICATION NETWORK

CERTIFICATE

IQNet and IRAM hereby certify that the organization **TARANTO SAN JUAN S.A.** Av. España N° 533 (5400) - Pcia. de San Juan - Argentina for the following field of activities: **Design, manufacture, sales, distribution and after sales servicing of gaskets, oil seals, rubber and rubber metal parts. Sales and distribution of spare parts.**

has implemented and maintains a **Management System** which fulfills the requirements of the following standard: **ISO 9001:2000**

Issued on: 2004-07-20
Validity date: 2007-07-20

Registration Number: **AR-OS-1031**

Dr. Fabio Romero, President of IQNet
Ing. José Francisco López, General Director of IRAM

IQNet
THE INTERNATIONAL CERTIFICATION NETWORK

CERTIFICATE

IQNet and IRAM hereby certify that the organization **TARANTO SAN JUAN S.A.** UT1: Av. España N° 533 Norte (5400) - Pcia. de San Juan; UT2: Av. España N° 800 Norte (5400) - Pcia. de San Juan; UT3: Eusebio Zapaola y Ruta Nacional 20 (5400) - Pcia. de San Juan - Argentina for the following field of activities: **Design and manufacture of gaskets, oil seals, rubber and rubber metal parts.**

has implemented and maintains a **Management System** which fulfills the requirements of the following standard: **ISO 14001:1996**

Issued on: 2004-07-20
Validity date: 2007-07-20

Registration Number: **AR-BS-145**

Dr. Fabio Romero, President of IQNet
Ing. José Francisco López, General Director of IRAM

SQS
The Swiss Association for Quality and Management Systems

SQS herewith certifies that the company named below has an appropriate management system which meets the requirements of the ISO/TS 16949:2002, second edition, 2002:04-01 and having been audited in accordance with the "Rules for the registration scheme for ISO/TS 16949:2002-Five edition". The SQS issues the company:

Taranto San Juan S.A.
Av. España 533
Argentina, 5400 San Juan

Certified area: **Whole Company**

Field of activity: **Design, manufacture, sales, distribution and after sales servicing of gaskets, oil seals, rubber and rubber metal parts**

on the basis of the audit result (March 25-31, 2004) the

SQS Certificate ISO/TS 16949:2002

Customer specific system requirements see appendix

CEI 3052 Zollikon, July 4, 2004
This SQS Certificate is valid up to and including July 3, 2007
Scope number 17
IATF Certificate number 0030756
Registration number 30038

President SQS: V. K. ... Managing Director SQS: T. Fabian

Todos los derechos reservados. Ninguna parte de esta publicación puede ser reproducida, almacenada por sistema de microfilm ni transmitida por medios electrónicos, fotocopia, grabación ni de ninguna otra manera, sin la previa autorización del titular del copyright.

All rights are reserved. None of de parts of this publication shall be reproduced, kept in a microfilm system or transmitted by electronic means, copied or taped by any other method without the previous agreement of the copyright owner.

FORMACIÓN DE CÓDIGOS - MATERIALES



ANTIGUA EXPRESION DE CODIGO TARANTO

FORMADA POR CINCO DÍGITOS

2 2 4 0 0

LINEA MOD. TIPO DE JUNTA

REFERENCIA ANTERIOR

NUEVA EXPRESION DE CODIGO TARANTO

FORMADA POR SEIS DÍGITOS

2 2 0 4 0 0

LINEA MODELO TIPO DE JUNTA

REFERENCIA NUEVA

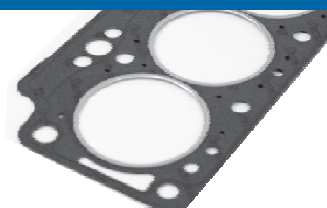

DOS PRIMEROS DÍGITOS

□ □

INDICA EL RUBRO O LINEA AL CUAL PERTENECE EL ARTÍCULO

ARTÍCULOS DE FABRICACIÓN

CODIFICACION

14 → AUTO UNIÓN
15 → CITROËN
20 → CHEVROLET - OPEL
21 → CHEVROLET - BEDFORD
CIMARRON - DI TELLA
22 → DODGE - VW
23 → VW - FORD
24 → CHEVROLET - GM
25 → FIAT
26 → FIAT
27 → FIAT
28 → CHEVROLET - GM
30 → FORD - VW
31 → FORD - MWM
32 → FORD - MWM
33 → FORD - MWM
35 → MERCEDES BENZ
36 → MERCEDES BENZ
40 → PERKINS / MF. / PF
41 → PERKINS / MF.
42 → PERKINS / MF.
43 → MAXION
45 → PEUGEOT - INDENOR
46 → PEUGEOT
47 → PEUGEOT
50 → RASTROJERO-INDENOR
VM - BORGWARD
51 → CHRYSLER
52 → CHRYSLER
54 → IKA - RENAULT - WILLYS
55 → RENAULT
56 → RENAULT - DACIA
57 → RENAULT
58 → RENAULT
65 → DEUTZ

66 → DEUTZ
70 → FIAT TRACTORES
71 → FIAT TRACTOR /CAMIÓN
75 → HANOMAG
80 → FIAT CAMIONES / IVECO
81 → SCANIA VABIS
85 → JOHN DEERE
86 → HONDA - ROVER
87 → CUMMINS
90 → ASIA MOTORS - KIA
NISSAN
91 → KIA - MITSUBISHI
SUZUKI - TOYOTA
92 → TATA
93 → ISUZU
94 → DAEWOO
95 → DAIHATSU - BMW
MITSUBISHI - TOYOTA
SUBARU
96 → MITSUBISHI
97 → TOYOTA - MAZDA - LADA
98 → BMW
99 → HYUNDAI

TERCER Y CUARTO DÍGITO

□ □

ESPECIFICA E IDENTIFICA EL TIPO DE MODELO AL QUE PERTENCE

ARTÍCULOS DE FABRICACIÓN

EJEMPLOS

CITROËN

00 → 2CV 14HP
01 → 2CV 18HP
02 → 3CV
04 → AMI 8

FIAT

00 → 1100
01 → 600
02 → 1500
03 → 1600
04 → 128 1100cc.
05 → 128 1300cc.
06 → 128 1500cc.
07 → 125
08 → 133
09 → REGATTA 100S
11 → DUCATO 2.8
20 → BRAVO/A TD
21 → BRAVO/A JTD

FORD

00 → FALCON 7B
01 → FALCON SP
02 → V8 FASE 1
03 → TAUNUS 2.0
04 → TAUNUS 2.3
05 → V8 FASE 2
06 → SIERRA 1.6
08 → A/AA
09 → FALCON 4B
14 → ESCORT 1.6
20 → TRANSIT 2.5
21 → FIESTA 1.4

PERKINS

00 → 4-203
01 → 6-305
02 → 6-354 F2
03 → 6PF-305
04 → 6-354 F4
05 → P3-152
06 → PF-MF
07 → MF M165-265
08 → MF 1095-1098
09 → 6-354 F1
10 → GM D20 3.9

PEUGEOT

00 → 404
01 → 504 1.6
02 → 504 1.8
03 → 504 2.0
04 → 504 XD2
05 → 505
06 → 505 I
07 → 505 XD3
09 → 403
15 → 205 1.0
16 → 106 1.4
17 → 106 1.2
18 → 104 1.2

RASTROJERO

00 → 42 HP
01 → 52 HP
02 → INDENOR 4,88
03 → INDENOR 6 CIL
04 → VM/BORGWARD

QUINTO Y SEXTO DÍGITO

□ □

DETERMINA EL TIPO DE JUNTA

ARTÍCULOS DE FABRICACIÓN

CODIFICACION

00 → Jgo. Junta Motor
01 → Jgo. Motor sin Tapa Cilindros
05 → Jta. Tapa Cilindro Metalamianto
06 → Jta. Tapa Cilindro Supermedida
07 → Jta. Tapa Cilindro Libre de Amianto
08 → Jta. Tapa Cilindro Metálica
10 → Jta. Tapa de Válvulas
11 → Jta. Cáster
12 → Jta. Distribución
13 → Jta. Contratapa Distribución
14 → Jta. Bomba de Agua
15 → Jta. Múltiple Escape Ferroflex y Chapa
16 → Jta. Múltiple Escape Ferroflex
17 → Jta. Múlt. Admisión
18 → Jta. Salida De Escape
19 → Jta. Placa De Agua
20 → Jgo. Jta. Carburador
21 → Jgo. Jta. Carburador
22 → Jgo. Jta. Carburador
23 → Jgo. Jta. Carburador
24 → Jgo. Jta. Carburador
25 → Jta. Base Carburador
26 → Jta. Tapa Carburador
27 → Jta. Bomba Aceite A Block
28 → Jta. Bomba De Nafta
29 → Arandela Tapón Cáster
30 → Arandela Tapa De Válvulas
36 → Jta. Tapa Válvulas Lateral
50 → Jgo. Caja De Velocidades
57 → Junta Palier
58 → Jgo. Bancada Cigüeñal
59 → Jta. Diferencial
60 → Jta Carter CGT
70 → Jgo. Suplemento Camisas
85 → Suplemento de Tapa
95 → Jgo. Descarbonización

ABREVIATURAS MATERIALES - ABBREVIATION OF MATERIALS

AC	Acero Inoxidable Stainless Steel	CU	Cobre Copper	NH	Libre Amianto Comprimido Compressed Asbestos Free
AL	Aluminio Aluminium	FIE	Fieltro Felt	SLS	Sterling - Polystrat Sterling - Polystrat
CB	Base Celulosa Cellulose Base	GS	Goma sintética - Nitrilo Synthetic Rubber - Nitrile	V	Vitón - Retenes con casco de acero Viton - Oil Seals with steel cap
CG	Corcho y Goma Cork and Rubber	NB	Libre Amianto (Beater) Asbestos Free (Beater)		
CGT	Corcho y Goma con Tela Cork and Rubber with Cloth	NFT	Ferroflex Base Libre Amianto Ferroflex Base Asbestos Free		



JUEGOS DE JUNTAS PARA CAJAS DE VELOCIDAD

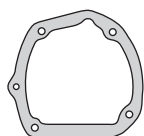

200063

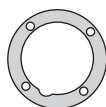

200064

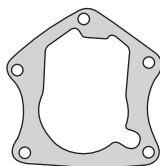

200065

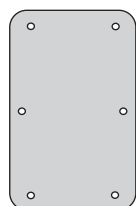

200056

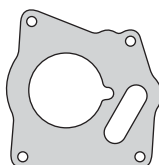

200057



200062



200066

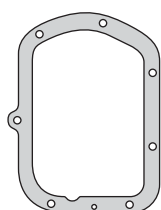

200156

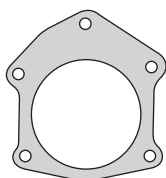

200157

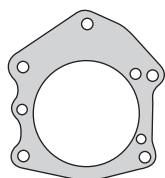

200162



200163



200164

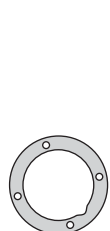

200252

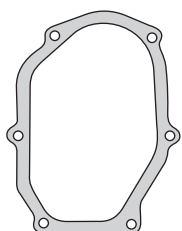

200253

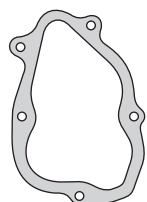

200254



200259

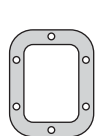

210352

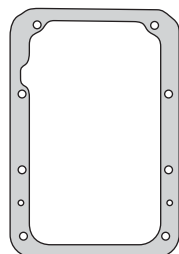

210154



210164



210165



210159



210162



210163

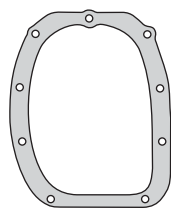

210351

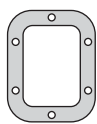

210352

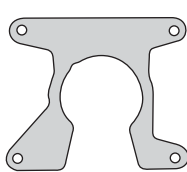

210353



210354



210357



210359

Caja Importada Apache **200050**

Chevrolet 400 - Pick Up - Hasta 1963

Descripción	Cant.	Mat.	Código
Junta Tapa Caja de Velocidad	1	CB	200063
Junta Directa Caja de Velocidad	1	CB	200064
Junta Acople Caja de Velocidad	1	CB	200065

2da. Serie - F.A.E. 1ra. Sincronizada **200051**

5752349 - 5753865 - 5748019

Chevrolet 400 - Super Pick Up

Descripción	Cant.	Mat.	Código
Junta Tapa Caja Sincronizada	1	CG	200056
Junta Acople Caja Sincronizada	1	CB	200057
Junta Directa con Vel. Sincronizada	1	CB	200062
Junta Directa con Velocidades	1	CB	200066

4 Velocidades Saginaw 1972/75 **200151**

Chevrolet Chevy - Coupe S y SS

Descripción	Cant.	Mat.	Código
Junta Tapa Caja Saginaw	1	NB	200156
Junta Acople con Velocidad	1	CB	200157
Junta Acople con Velocidad	1	CB	200162
Junta Directa Caja de Velocidad	1	CB	200163
O'ring G17.12 x 2.62	1	GS	200164

FAE desde 1975 **200250**

Chevrolet - Opel K-180 - Chevette 1973/... - Clarck 4/5

Descripción	Cant.	Mat.	Código
Junta Caja de Velocidad	1	NFT	200252
Junta Caja de Velocidad	1	CB	200253
Junta Caja de Velocidad	1	CB	200254
Junta Palanca Cambios F.A.E - Opel	1	CB	200259

475 - Caja de 5ª FAE **210150**

Chevrolet Camión 350 - Ford F700 - Dodge DP 800

Descripción	Cant.	Mat.	Código
Junta Caja de Velocidad	1	CB	210154
Junta Directa Caja de Velocidad	1	CB	210159
Junta Palanca Caja de Velocidad	1	CB	210162
Junta Tras. c/e Caja de Velocidad	1	CB	210163
Junta Tras. e/i Caja de Velocidad	1	CB	210164
Junta Vel. Caja de Velocidad	1	CB	210165
Junta Caja de Velocidad	2	CB	210352

P432 - Naftero y Gasolero Caja Vauxhall **210350**

Bedford - Dodge D100/400 - DP400 1963/65

Descripción	Cant.	Mat.	Código
Junta Caja de Velocidad	1	CB	210351
Junta Caja de Velocidad	1	CB	210352
Junta Caja de Velocidad	1	CB	210353
Junta Caja Velocidad	1	CB	210354
Junta Acople Caja de Velocidad	1	CB	210357
Junta Directa	1	CB	210359

JUEGOS DE JUNTAS PARA CAJAS DE VELOCIDAD

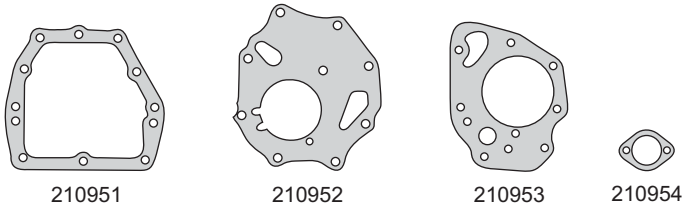

210950

Di Tella 1500 - 1650

Descripción	Cant.	Mat.	Código
Junta Caja de Velocidad	1	CB	210951
Junta Caja de Velocidad	1	CB	210952
Junta Caja de Velocidad	1	CB	210953
Junta Caja de Velocidad	1	CB	210954

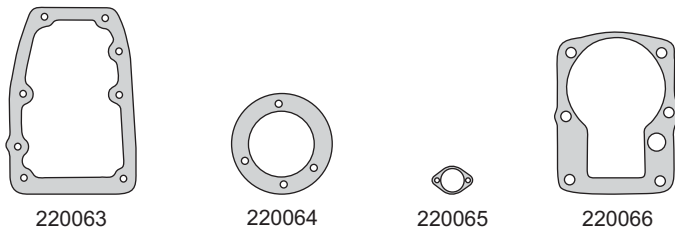

220050

Dodge Valiant I y II - Pick Up - Desoto Pick Up 1951/61

Descripción	Cant.	Mat.	Código
Junta Tapa Caja de Velocidad	1	CG	200063
Junta Directa Caja de Velocidad	1	CB	220064
Junta Caja de Velocidad	1	CB	220065
Junta Acople Caja de Velocidad	1	CB	220066

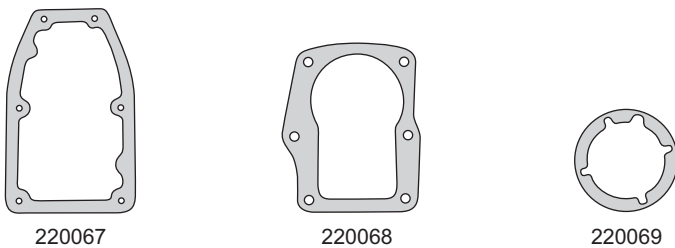

220051

D100/200 2929456

Dodge Valiant III/IV - Pick Up - Desoto Pick Up D100/200 82/87

Descripción	Cant.	Mat.	Código
Junta Tapa Caja de Velocidad	1	CG	220067
Junta Exterior Caja	1	CB	220068
Junta Directa Caja de Velocidad	1	CB	220069

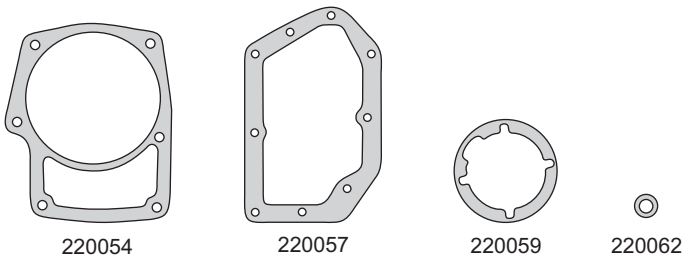

220052

Caja Mexicana A230 - 4 Velocidades

Dodge Coronado 4V - GTX - Polara

Descripción	Cant.	Mat.	Código
Junta Caja de Velocidad	1	CB	220054
Junta Exterior Caja Mexicana	1	CB	220057
Junta Directa Caja Mexicana	1	CB	220059
Junta Arandela Caja Mexicana	1	CB	220062

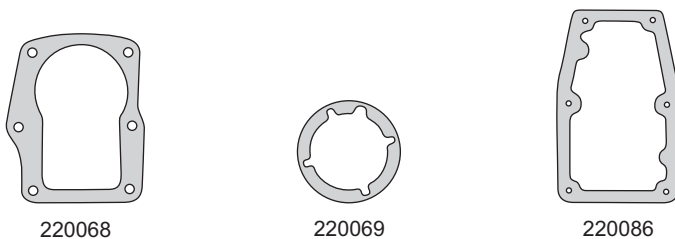

220053

3 Velocidades

Dodge Polara

Descripción	Cant.	Mat.	Código
Junta Exterior Caja de Velocidad	1	CB	220068
Junta Directa Caja de Velocidad	1	CB	220069
Junta Tapa Caja de Velocidad	1	CG	220086

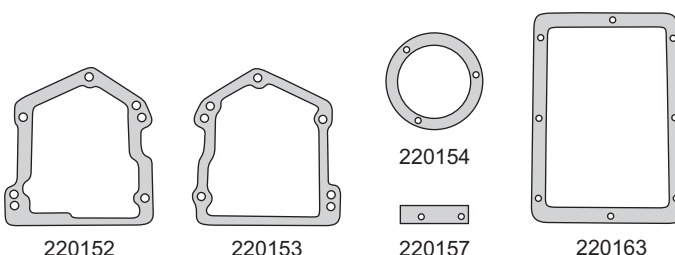

220150

4 Velocidades

Dodge 1500 - VW 1500/1800 - Todos

Descripción	Cant.	Mat.	Código
Junta Caja de Velocidad	1	CB	220152
Junta Caja de Velocidad	1	CB	220153
Junta Caja de Velocidad	1	CB	220154
Junta Varilla Cam. Caja de Velocidad	1	CB	220157
Junta Tapa Caja de Velocidad	1	CB	220163



JUEGOS DE JUNTAS PARA CAJAS DE VELOCIDAD

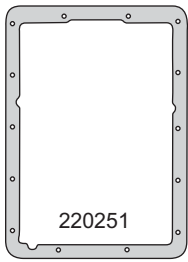

220251

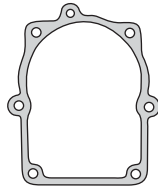

220252

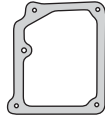

220253



220263



220262



220254

Caja Automática BW-45

220151

Chevrolet 400 - Pick Up - Hasta 1963

Descripción	Cant.	Mat.	Código
Junta Caja de Velocidad	1	CG	220251
Junta Caja de Velocidad	1	NB	220252
Junta Caja de Velocidad	1	CG	220253
Junta Caja de Velocidad	1	CB	220254
Junta Accesorios Cambios	1	CB	220262
Junta Accesorios Cambios	1	NB	220263

Caja Tipo II - 4 Velocidades

220350

Volkswagen Kombi - Escarabajo 1.3

Descripción	Cant.	Mat.	Código
Junta Caja de Velocidad	1	CB	220351
Junta Caja de Velocidad	1	CB	220352

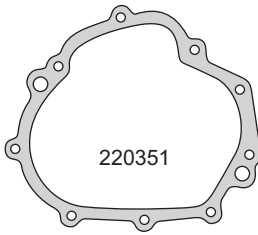

220351

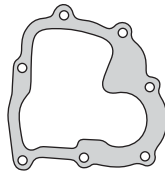

220352

5 Velocidades - 1.8 lts - Nafta/Diesel

220450

Volkswagen Gacel - Saveiro - Senda - Gol - Passat

Descripción	Cant.	Mat.	Código
Junta Caja de Velocidad	1	NB	220453
Junta Caja de Velocidad	1	CB	220454
Junta Acople Caja de Velocidad	1	CB	220456
O'ring G 168 x 3.5	1	GS	220459

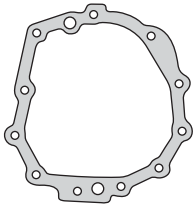

220453

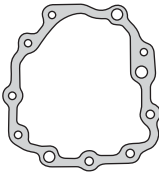

220454

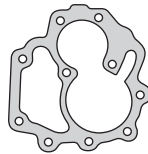

220456

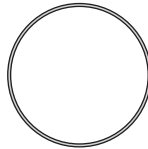

220459

4 Velocidades - 1ª Serie 1983/85

220451

Volkswagen Gacel GL

Descripción	Cant.	Mat.	Código
Junta Caja de Velocidad	1	NB	220453
Junta Caja de Velocidad	1	NB	220455
Junta Acople Caja de Velocidad	1	CB	220456
O'ring G 168 x 3.5	1	GS	220459

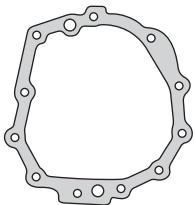

220453

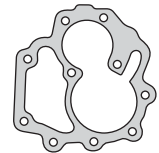

220455

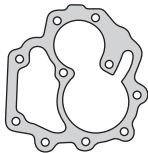

220456

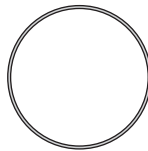

220459

4 Velocidades - 2ª Serie 1985/...

220452

Volkswagen Gacel

Descripción	Cant.	Mat.	Código
Junta Caja de Velocidad	1	NB	220453
Junta Acople Caja de Velocidad	1	NB	220457
O'ring G 168 x 3.5	1	GS	220459

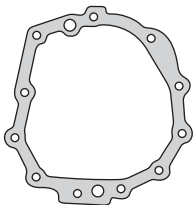

220453

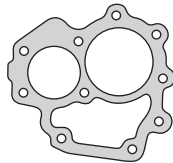

220457

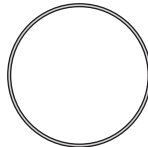

220459

220950

Chrysler - Dodge DD1000 - Fiat 673 - Todos

Descripción	Cant.	Mat.	Código
Junta Caja de Velocidad	1	NB	220951
Junta Caja de Velocidad	1	NB	220952
Junta Caja de Velocidad	1	NB	220953
Junta Caja de Velocidad	1	NB	220954

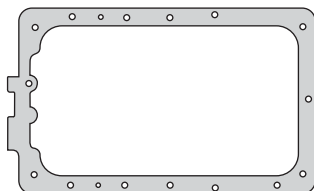

220951



220952

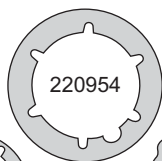

220954



220953

JUEGOS DE JUNTAS PARA CAJAS DE VELOCIDAD

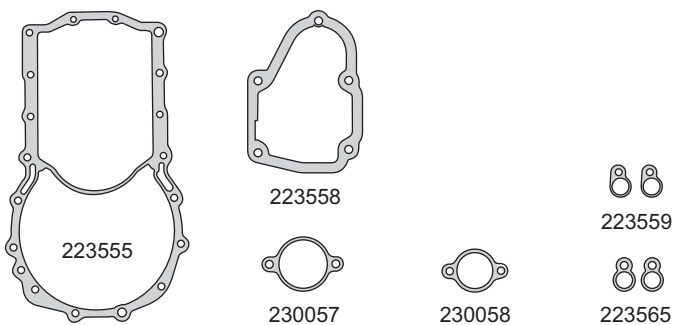

Caja MQ250			
223550			
VW/Audi/Seat New Beetle - Bora - Polo - Golf - Ibiza - Cordoba			
Descripción	Cant.	Mat.	Código
Junta Frente Caja de Velocidad	1	NB	223555
Guarnición Acople Trasero	1	GS	223558
Junta Acople Lateral Derecho	2	NB	223559
Junta Acople Lateral Izquierdo	2	NB	223565
Junta Brida Lateral	1	NB	230057
Junta Brida Lateral	1	NB	230058

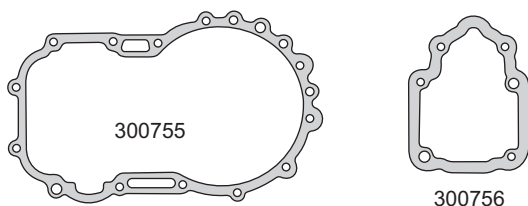

Caja 827			
230050			
Volkswagen Carat - Galaxy 1996/... - Escort XR3 - Motor Audi			
Descripción	Cant.	Mat.	Código
Junta Caja de Velocidad	1	NB	300755
Junta Caja de Velocidad	1	NB	300756

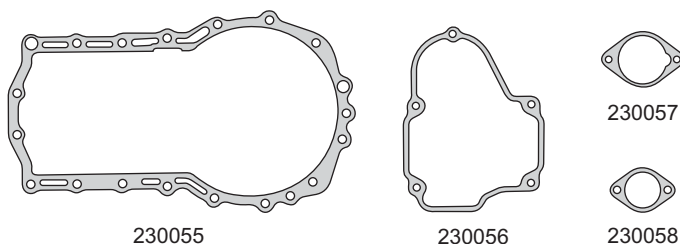

Caja 827 MQ			
230051			
Volkswagen Pointer - Orion - Escort - Golf - Polo Diesel			
Descripción	Cant.	Mat.	Código
Junta Caja de Velocidad	1	NB	230055
Junta Selectora	1	NB	230057
Junta Guía Selectora	1	NB	230058
Junta Tapa Trasera	1	P	230059

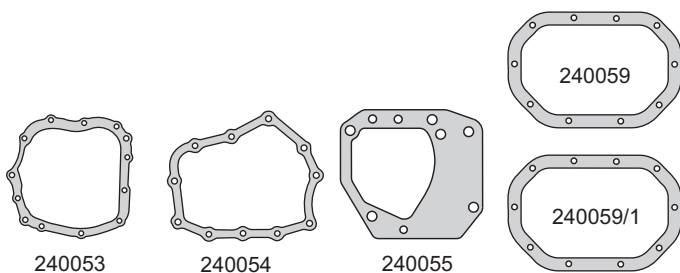

Caja Clark - 4/5 Velocidades			
240050			
Opel - Monza 1.6/1.8/2.0			
Descripción	Cant.	Mat.	Código
Junta Tapa Cierre	1	NB	240053
Junta Acople Caja	1	NB	240054
Junta Tapa Lateral	1	NB	240055
Junta Cáster Diferencial	1	NB	240059
Junta Cáster Diferencial	1	CG	240059/1

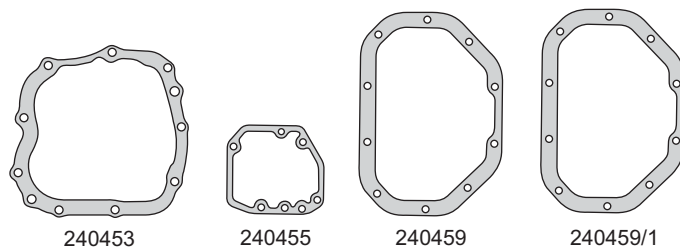

5 Velocidades - Todos			
240450			
Chevrolet Corsa - Combo - Astra 1.4/1.6 Todos			
Descripción	Cant.	Mat.	Código
Junta Tapa Cierre	1	CB	240453
Junta Tapa Lateral	1	CB	240455
Junta Cáster Diferencial	1	CB	240459
Junta Cáster Diferencial	1	CG	240459/1

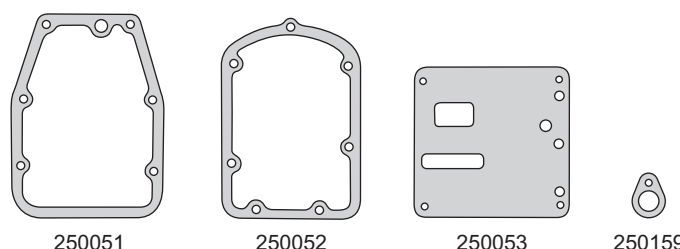

4 Velocidades			
250050			
Fiat 1100			
Descripción	Cant.	Mat.	Código
Junta Caja de Velocidad	1	CB	250051
Junta Caja de Velocidad	1	CB	250052
Junta Caja de Velocidad	1	CB	250053
Junta Velocímetro Caja Velocidad	1	CB	250159



JUEGOS DE JUNTAS PARA CAJAS DE VELOCIDAD

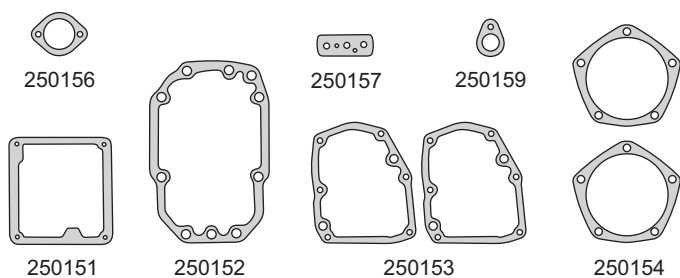

4 Velocidades

250150

Fiat 600 - 600 E.D.F.R. - 750 - 880

Descripción	Cant.	Mat.	Código
Junta Tapa Caja de Velocidad	1	CG	250151
Junta Caja de Velocidad	1	CB	250152
Junta Separador Caja Velocidad	2	CB	250153
Junta Caja de Velocidad	2	CB	250154
Junta Directa Caja de Velocidad	1	CB	250156
Junta Varilla Caja de Velocidad	1	CB	250157
Junta Velocímetro Caja Velocidad	1	CB	250159

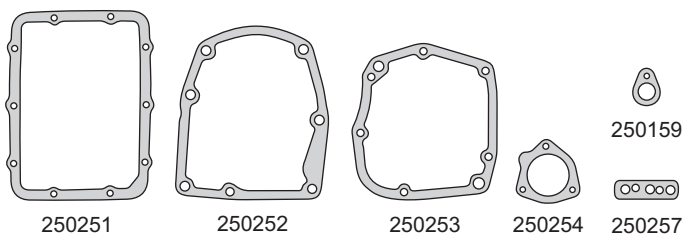

1ra. Serie - 4 Velocidades

250250

Fiat 1300/1500 - 1600 - 125 - Lada 1.6 - Niva 2121

Descripción	Cant.	Mat.	Código
Junta Velocímetro Caja de Velocidad	1	CB	250159
Junta Caja de Velocidad	1	CB	250251
Junta Caja de Velocidad	1	CB	250252
Junta Caja de Velocidad	1	CB	250253
Junta Caja de Velocidad	1	CB	250254
Junta Varillaje Caja de Velocidad	1	CB	250257

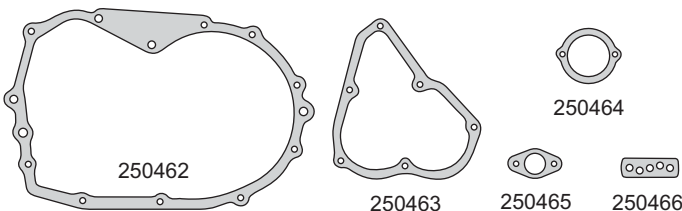

4 Velocidades

250450

Fiat 127/128/1100/1300 - Sport - Torino - Ritmo 60 - Hasta 1977

Descripción	Cant.	Mat.	Código
Junta Frente Caja de Velocidad	1	CB	250462
Junta Cola Caja de Velocidad	1	CB	250463
Junta Directa Caja de Velocidad	1	CB	250464
Junta Velocímetro Caja de Velocidad	1	CB	250465
Junta Varillaje Caja de Velocidad	1	CB	250466

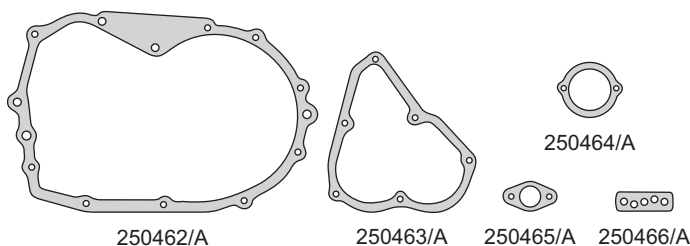

4 Velocidades

250451

Fiat 128 - 1100/1300 - Hasta 1977

Descripción	Cant.	Mat.	Código
Junta Frente Caja de Velocidad	1	NB	250462/A
Junta Acople Caja de Velocidad	1	NB	250463/A
Junta Directa Caja de Velocidad	1	NB	250464/A
Junta Velocímetro Caja de Vel.	1	NB	250465/A
Junta Varillaje Caja de Velocidad	1	NB	250466/A

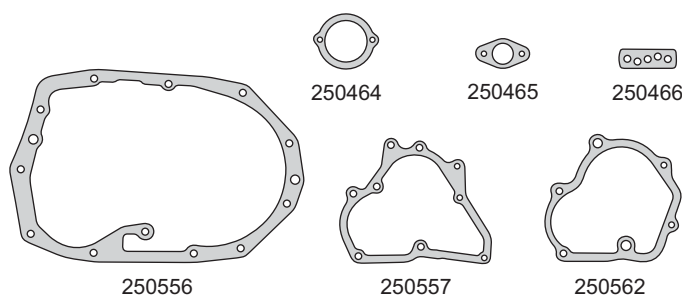

Caja de 4ta y 5ta

250550

Fiat 128 - 1100/1500 - Europa - Super Europa - Ritmo 60

Descripción	Cant.	Mat.	Código
Junta Directa Caja de Velocidad	1	CB	250464
Junta Velocímetro Caja de Vel.	1	CB	250465
Junta Varillaje Caja de Velocidad	1	CB	250466
Junta Frente Caja de Velocidad	1	CB	250556
Junta Acople Caja de Velocidad	1	CB	250557
Junta Lateral Caja de Velocidad	1	CB	250562

JUEGOS DE JUNTAS PARA CAJAS DE VELOCIDAD

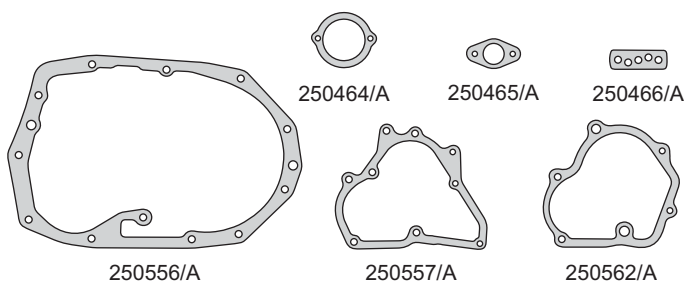

Caja de 4ta y 5ta			
250551			
Fiat 128 - 1100/1500 - Europa - Super Europa			
Descripción	Cant.	Mat.	Código
Junta Directa Caja de Velocidad	1	NH	250464/A
Junta Velocímetro Caja de Vel.	1	NH	250465/A
Junta Varillaje Caja de Velocidad	1	NH	250466/A
Junta Frente Caja de Velocidad	1	NH	250556/A
Junta Salida Caja de Velocidad	1	NH	250557/A
Junta Salida Lateral Caja	1	NH	250562/A

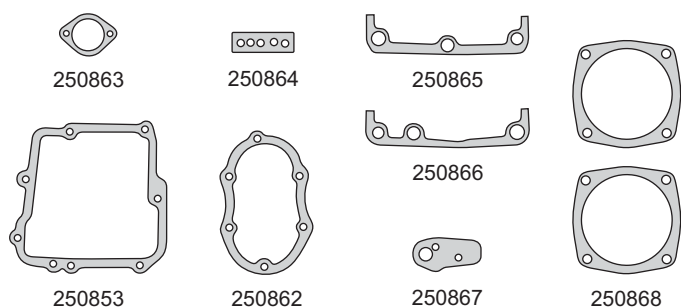

4 Velocidades			
250850			
Fiat 133 - 600S			
Descripción	Cant.	Mat.	Código
Junta Caja de Velocidad	1	NB	250853
Junta Acople Caja de Velocidad	1	NB	250862
Junta Directa Caja de Velocidad	1	CB	250863
Junta Varillaje Caja de Velocidad	1	CB	250864
Junta Frente Izq. Caja de Velocidad	1	CB	250865
Junta Frente Derecho Caja de Vel.	1	CB	250866
Junta Velocímetro	1	NB	250867
Junta Palier con Velocidad	2	CG	250868

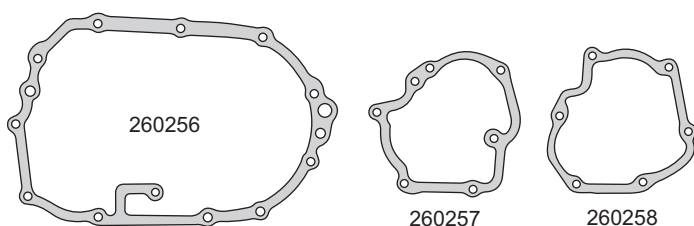

Caja Nacional - 5 Velocidades			
260250			
Fiat Ducato - 1.7/1.9 Nafta - 2.5/2.8 D/TD			
Descripción	Cant.	Mat.	Código
Junta Caja de Velocidad	1	NH	260256
Junta Placa Interior	1	NB	260257
Junta Placa Exterior	1	NB	260258

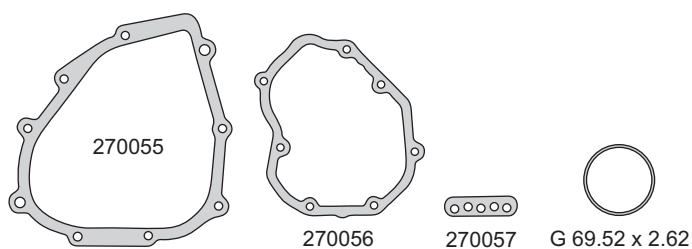

4 Velocidades			
270050			
Fiat Ducato 1.7/1.9 Nafta - 2.5/2.8 D/TD			
Descripción	Cant.	Mat.	Código
Junta Tapa Caja de Velocidad	1	CB	270055
Junta Acople Caja de Velocidad	1	CB	270056
Junta Bolillero Caja de Velocidad	1	CB	270057
O'ring G 69.52 x 2.62	1	GS	G 69.52 x 2.62

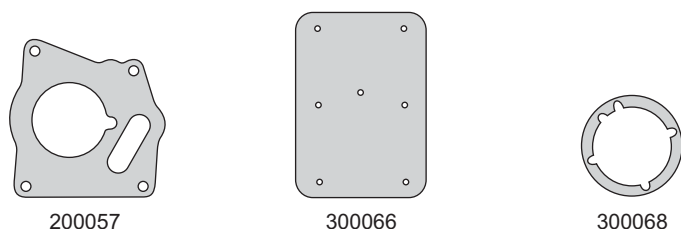

Caja FAE - 3 Velocidades			
300050			
Ford Falcon 1964/68			
Descripción	Cant.	Mat.	Código
Junta Acople Caja de Velocidad	1	CB	200057
Junta Caja de Velocidad	1	CG	300066
Junta Directa Caja de Velocidad	1	CB	300068

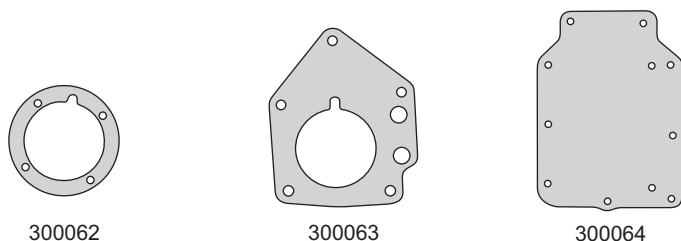

Caja 303 - 1ª Sincronizada - 3 Velocidades			
300051			
Ford F100 - Fairlane 1966/77			
Descripción	Cant.	Mat.	Código
Junta Directa Caja de Velocidad	1	CB	300062
Junta Acople Caja de Velocidad	1	CB	300063
Junta Tapa Caja de Velocidad	1	CB	300064



JUEGOS DE JUNTAS PARA CAJAS DE VELOCIDAD

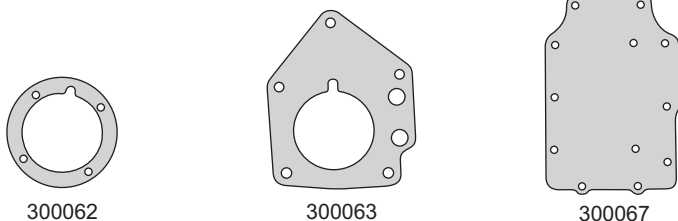

300062

300063

300067

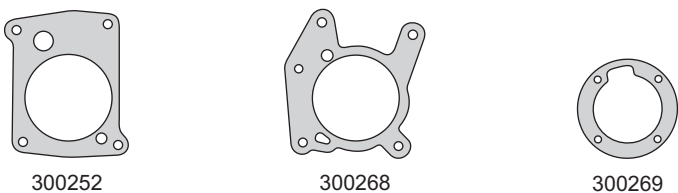

300252

300268

300269

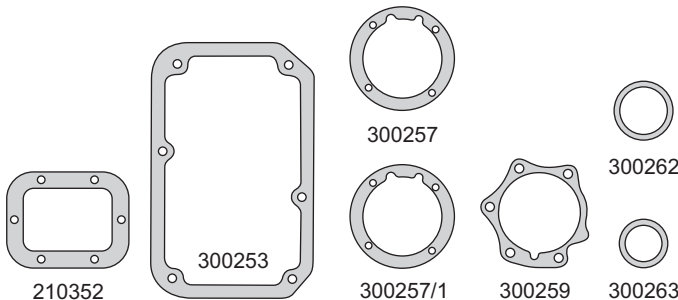

210352

300253

300257

300257/1

300259

300262

300263

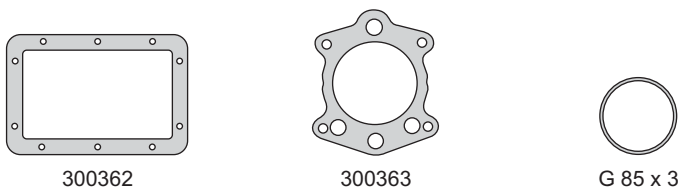

300362

300363

G 85 x 3

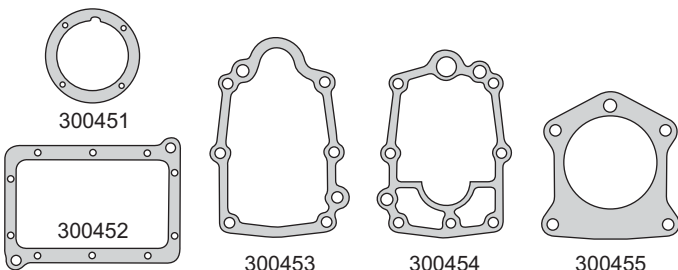

300451

300452

300453

300454

300455

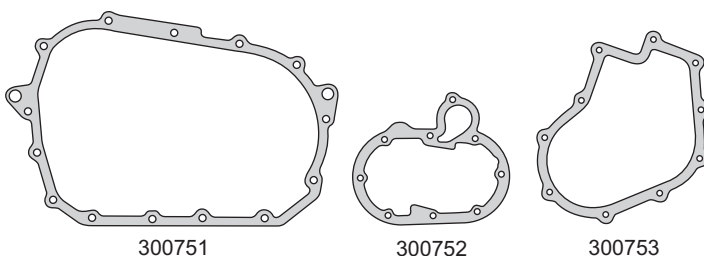

300751

300752

300753

4 Velocidades - TRANSAX 325

300052

Ford Falcon

Descripción	Cant.	Mat.	Código
Junta Directa Caja de Velocidad	1	CB	300062
Junta Acople Caja de Velocidad	1	CB	300063
Junta Tapa Caja de Velocidad	1	CB	300067

Importado - 3 Velocidades

300250

Ford F100 1962/63

Descripción	Cant.	Mat.	Código
Junta Caja de Velocidad	1	CB	300252
Junta Acople Caja de Velocidad	1	CB	300268
Junta Directa Caja de Velocidad	1	CB	300269

Caja Clarck 450B - T98

300251

Ford F350 - F600 1960/67 y 1956/64

Descripción	Cant.	Mat.	Código
Junta Caja de Velocidad	1	CB	210352
Junta Caja de Velocidad	1	CB	300253
Junta Directa Caja de Velocidad	1	CB	300257
Junta Directa Caja de Velocidad	1	CB	300257/1
Junta Contraeje Caja Velocidad	1	CB	300259
Junta Arandela Caja Velocidad	1	CB	300262
Junta Arandela Caja Velocidad	1	CB	300263

4 Velocidades

300350

Ford Taunus 2.0-2.3 - Ford Sierra 2.3

Descripción	Cant.	Mat.	Código
Junta Tapa Caja de Velocidad	1	CB	300362
Junta Acople con Velocidades	1	CB	300363
O'ring G 85 x 3	1	GS	300364

5 Velocidades

300450

Ford Taunus - Sierra

Descripción	Cant.	Mat.	Código
Junta Caja de Velocidad	1	CG	300451
Junta Caja de Velocidad	1	CB	300452
Junta Caja de Velocidad	1	NB	300453
Junta Caja de Velocidad	1	NB	300454
Junta Caja de Velocidad	1	NB	300455

5 Velocidades

300750

Ford 1.3/1.5 Escort GL - GS - Ka - Fiesta - Orion 1995/...

Descripción	Cant.	Mat.	Código
Junta Caja de Velocidad	1	NB	300751
Junta Caja de Velocidad	1	NH	300752
Junta Caja de Velocidad	1	CG	300753

JUEGOS DE JUNTAS PARA CAJAS DE VELOCIDAD

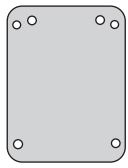

300962



300963



300964

Importado - 3 Velocidades

300950

Ford Falcon

Descripción	Cant.	Mat.	Código
Junta Tapa Caja de Velocidad	1	CB	300962
Junta Acople Caja de Velocidad	1	CB	300963
Junta Directa Caja de Velocidad	1	CB	300964

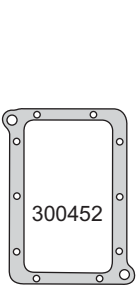

300452

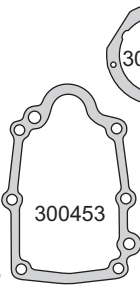

300453



300154

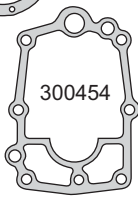

300454



300155

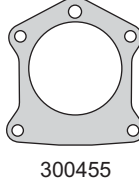

300455

5ta. Hummer Naftera 1990

310053

Ford F100

Descripción	Cant.	Mat.	Código
Junta Caja de Velocidad	1	CG	300154
Junta Caja de Velocidad	1	NB	300155
Junta Caja de Velocidad	1	CB	300452
Junta Caja de Velocidad	1	NB	300453
Junta Caja de Velocidad	1	NB	300454
Junta Caja de Velocidad	1	NH	300455

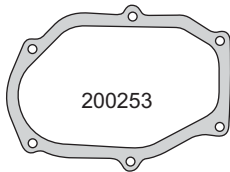

200253



310453

Clarck - 5 Velocidades

310450

Ford F100 - F1000 - Motor MWM Diesel 1992

Descripción	Cant.	Mat.	Código
Junta Caja de Velocidad	1	NB	200253
Junta Directa Caja de Velocidad	1	NFT	310453

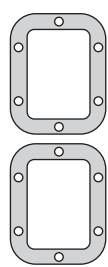

210352

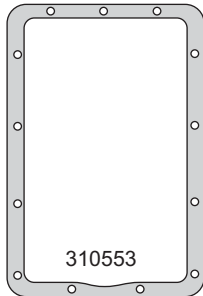

310553



310554



310555

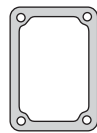

310559

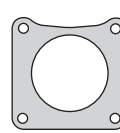

310561

Eaton Manual Caja 450 - 5 Velocidades

310550

Ford F2000 - F11000 - F14000 - Motor MWM 1992/... Chevrolet A60/D60 1985/91 Diesel 6 cilin.

Descripción	Cant.	Mat.	Código
Junta Caja de Velocidad	2	CB	210352
Junta Tapa Caja de Velocidad	1	CB	310553
Junta Directa	1	CB	310554
Junta Trasera	1	CB	310555
Junta Torreta	1	NB	310559
Junta Inspección Lateral	1	NB	310561

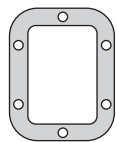

210352

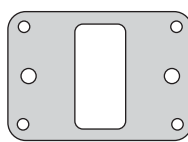

310553

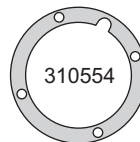

310554

310564

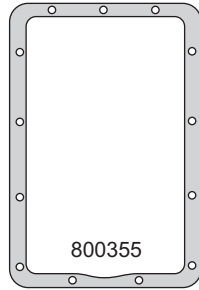

800355

T75 - 7153 - A

310551

MWM - F - Ford 14000

Descripción	Cant.	Mat.	Código
Junta Caja de Velocidad	2	CB	210352
Junta Caja de Velocidad	1	CB	310553
Junta Directa Caja de Velocidad	1	CB	310554
Junta Tapa Inspección	1	NB	310564
Junta Caja de Velocidad	1	NB	800355

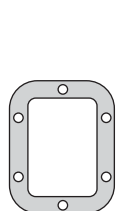

210352

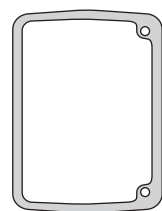

350051

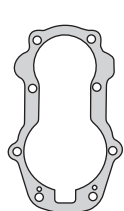

350052



350053

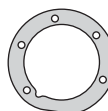

350366

Caja G-27

350050

Mercedes Benz 3500 - 1112 - 4500

Descripción	Cant.	Mat.	Código
Junta Caja de Velocidad	1	CB	210352
Junta Caja de Velocidad	1	CB	350051
Junta Caja de Velocidad	1	CB	350052
Junta Caja de Velocidad	1	CB	350053
Junta Directa Caja de Velocidad	1	NB	350366



JUEGOS DE JUNTAS PARA CAJAS DE VELOCIDAD

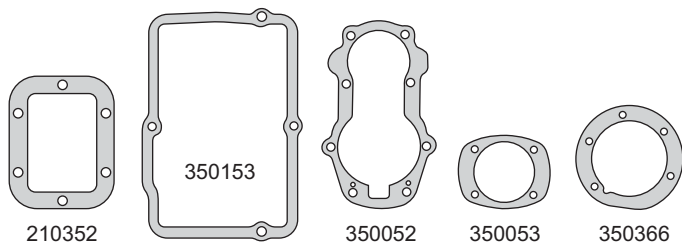

Caja G-20/G-24

350150

Mercedes Benz L608 - 710

Descripción	Cant.	Mat.	Código
Junta Caja de Velocidad	1	CB	210352
Junta Caja de Velocidad	1	CB	350052
Junta Caja de Velocidad	1	CB	350053
Junta Caja de Velocidad	1	CB	350153
Junta Directa Caja de Velocidad	1	NB	350366

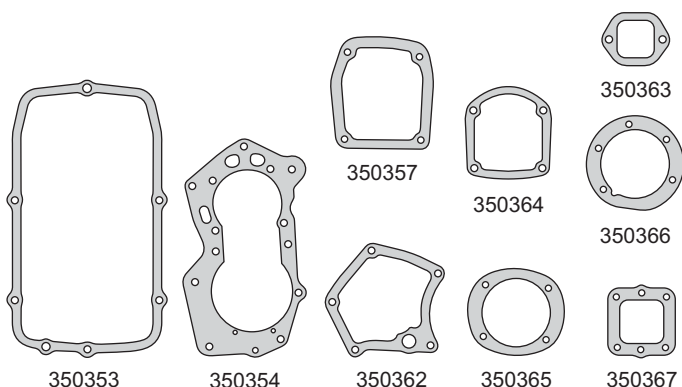

Caja G-32

350350

Mercedes Benz 1112 - 1114

Descripción	Cant.	Mat.	Código
Junta Caja de Velocidad	1	CB	350353
Junta Tapa Trasera Caja de Vel.	1	CB	350354
Junta Tapa Lateral Superior	1	NB	350357
Junta Caja de Velocidad	1	NB	350362
Junta Cierre Tapa Superior	1	NB	350363
Junta Acople Trasero Caja de Vel.	1	NB	350364
Junta Tapa Delantera Inferior	1	NB	350365
Junta Directa Caja de Velocidad	1	NB	350366
Junta Soporte Palanca Cambios	1	NB	350367

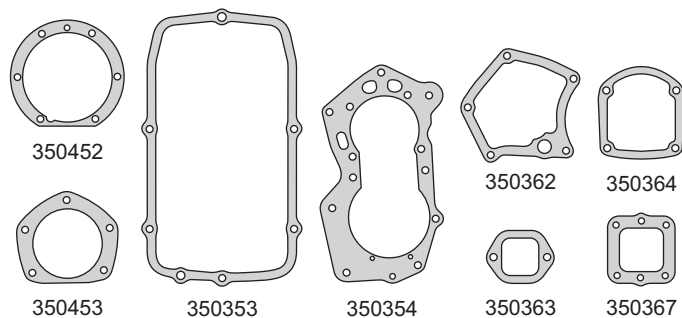

Caja G-60/G-50 - 5 Velocidades

350450

Mercedes Benz 1517 - 1518 - OH1419

Descripción	Cant.	Mat.	Código
Junta Caja de Velocidad	1	CB	350353
Junta Tapa Trasera Caja Velocidad	1	CB	350354
Junta Caja de Velocidad	1	NB	350362
Junta Cierre Tapa Superior	1	NB	350363
Junta Acople Trasero	1	NB	350364
Junta Soporte Palanca de Cambios	1	NB	350367
Junta Caja de Velocidad	1	NB	350452
Junta Caja de Velocidad	1	NB	350453

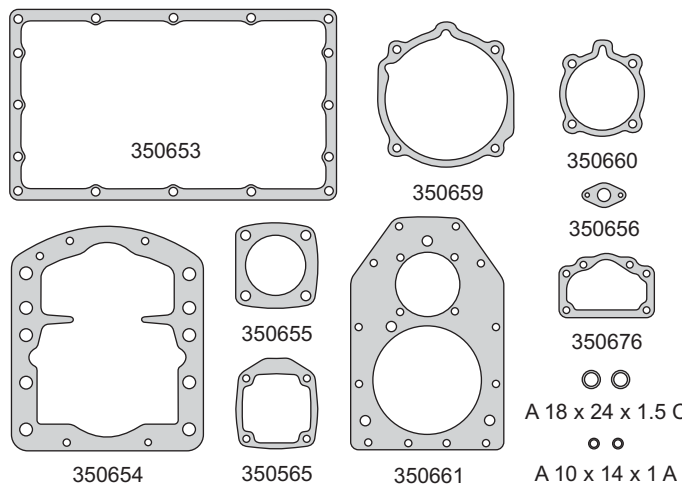

Caja GV80

350650

Mercedes Benz 1521 - OM355 - GV80

Descripción	Cant.	Mat.	Código
Junta Caja de Velocidad	1	NH	350656
Junta Caja de Velocidad	1	NH	350653
Junta Diferencial	1	NH	350656
Junta Caja de Velocidad	1	NH	350659
Junta Caja de Velocidad	1	NH	350654
Junta Caja de Velocidad	1	NH	350655
Junta Caja de Velocidad	1	NH	350660
Junta Tapa Caja de Velocidad	1	NH	350661
Junta Caja de Velocidad	1	NH	350676
Arandelas A 10 x 14 x 1 A	2	AL	
Arandelas A 18 x 24 x 1.5 C	2	CU	

JUEGOS DE JUNTAS PARA CAJAS DE VELOCIDAD

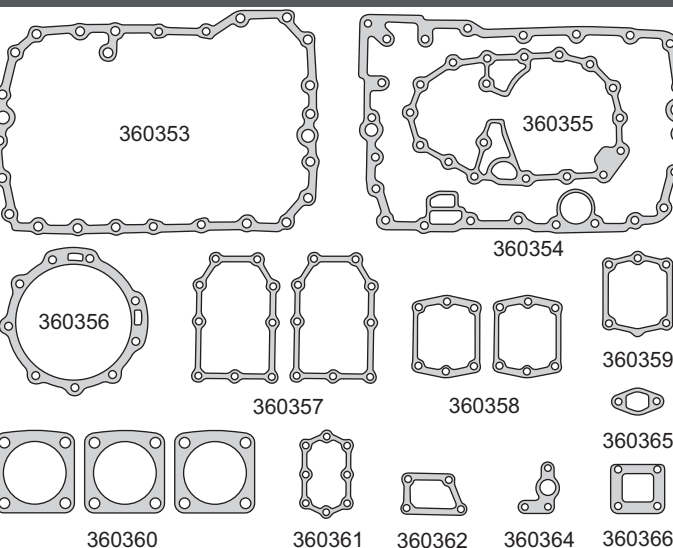
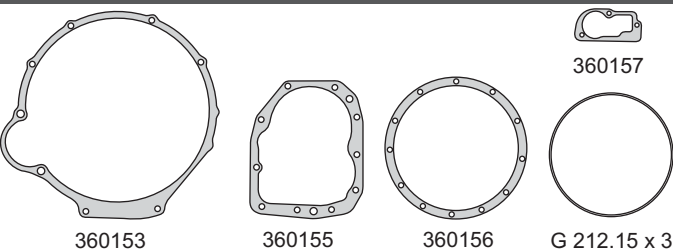
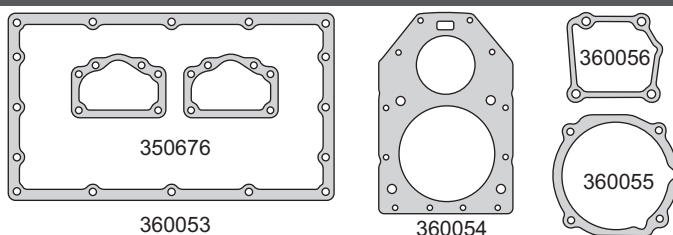
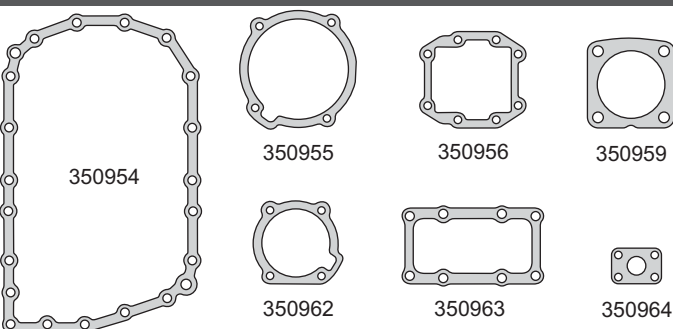
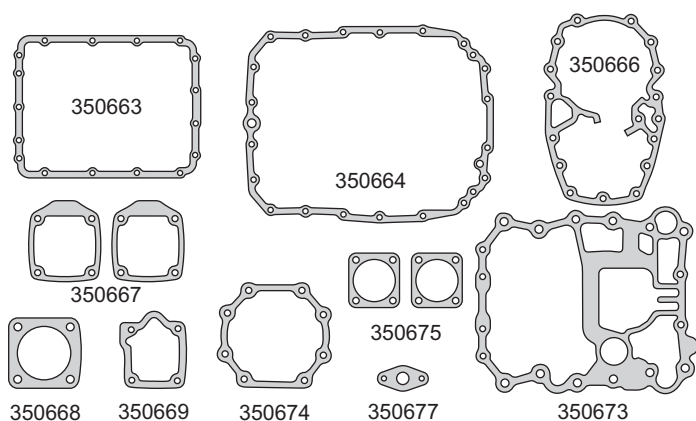

Caja G120-ZF 350651			
Mercedes Benz 1526 - OM355/355A			
Descripción	Cant.	Mat.	Código
Junta Tapa Caja de Velocidad	1	NH	350663
Junta Caja de Velocidad	1	NH	350664
Junta Caja de Velocidad	1	NH	350666
Junta Caja de Velocidad	2	NH	350667
Junta Caja de Velocidad	1	NH	350668
Junta Caja de Velocidad	1	NH	350669
Junta Caja de Velocidad	1	NH	350674
Junta Caja de Velocidad	1	NH	350675
Junta Caja de Velocidad	1	NH	350677
Junta Caja de Velocidad	1	NH	350673
Junta Caja de Velocidad	2	NH	350675
Junta Caja de Velocidad	1	NH	350677

Caja ZF S5-680 350950			
Mercedes Benz 1218 - L1620 OKR M366			
Descripción	Cant.	Mat.	Código
Junta Caja de Velocidad	1	NB	350954
Junta Directa Caja de Velocidad	1	NB	350955
Junta Tapa Inferior	1	NB	350956
Junta Válvula Distribución	1	NB	350959
Junta Tapa Delantera	1	NB	350962
Junta Tapa Trasera	1	NB	350963
Junta Guía Directa	1	NB	350964

Caja G-90/G-105 - 6 Velocidades 360050			
Mercedes Benz OM447/449 - G90 - G105			
Descripción	Cant.	Mat.	Código
Junta Acople Caja de Velocidad	2	NB	350676
Juego Caja de Vel. (360053 / 360054)	1	NB	360050G1
Junta Delantera Caja	1	NB	360055
Junta Tapa Caja de Velocidad	1	NB	360056

4 Velocidades 360150			
Mercedes Benz 180D - OM616			
Descripción	Cant.	Mat.	Código
Junta Frente Caja de Velocidad	1	NB	360153
Junta Trasera Caja de Velocidad	1	NB	360155
Junta Diferencial Caja de Velocidad	1	NB	360156
Junta Leva Lateral	1	NB	360157
O'ring G 212.15 x 3	1	GS	

Caja 85130-16S130 - ZF 8 Velocidades 360350			
Mercedes Benz OM366 16S130 - Intercooler LA OM 447/449 - 1622/1633/1938			
Descripción	Cant.	Mat.	Código
Junta Caja de Velocidad	1	NH	360353
Junta Caja de Velocidad	1	NH	360354
Junta Caja de Velocidad	1	NH	360355
Junta Caja de Velocidad	1	NH	360356
Junta Caja de Velocidad	2	NH	360357
Junta Caja de Velocidad	2	NH	360358
Junta Caja de Velocidad	1	NH	360359
Junta Caja de Velocidad	3	NH	360360
Junta Caja de Velocidad	1	NH	360361
Junta Caja de Velocidad	1	NH	360362
Junta Caja de Velocidad	1	NH	360364
Junta Caja de Velocidad	1	NH	360365
Junta Caja de Velocidad	1	NH	360366



JUEGOS DE JUNTAS PARA CAJAS DE VELOCIDAD

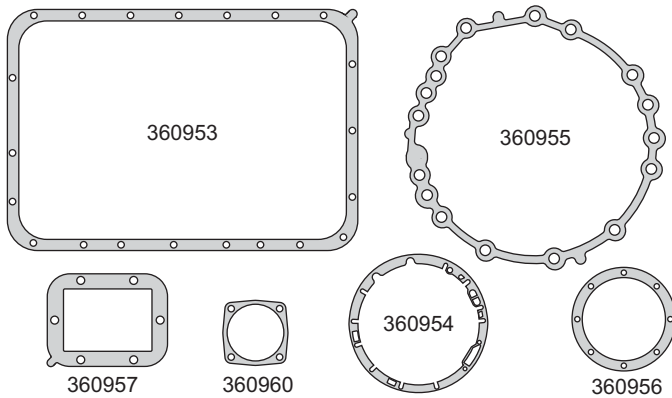

360950

Mercedes Benz OHL 1320/1420 OH 1621L/1721L

Descripción	Cant.	Mat.	Código
Junta Caja de Cambios	1	NB	360953
Junta Caja de Cambios	1	NB	360954
Junta Caja de Cambios	1	NB	360955
Junta Caja de Cambios	1	NB	360956
Junta Caja de Cambios	1	NB	360957
Junta Caja de Cambios	1	NB	360960

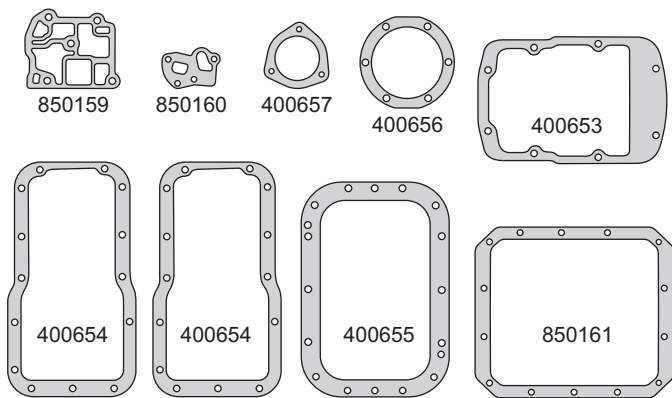

400650

Transmisión y Mando

Massey Ferguson - Tractor - Todos

Descripción	Cant.	Mat.	Código
Junta Caja de Velocidad	1	NFT	400653
Junta Caja de Velocidad	1	NFT	400654
Junta Caja de Velocidad	2	NFT	400655
Junta Caja de Velocidad	1	NB	400656
Junta Caja de Velocidad	1	NB	400657

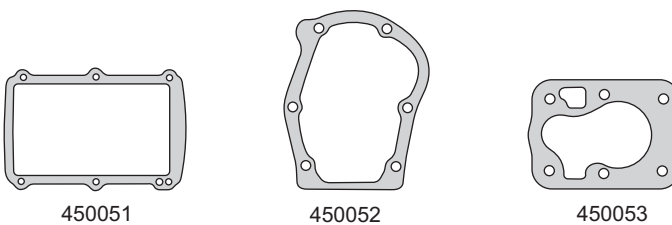

450050

Caja C3B - 4 Velocidades

Peugeot - 404/504 1967/70

Descripción	Cant.	Mat.	Código
Junta Caja de Velocidad	1	CB	450051
Junta Caja de Velocidad	1	CB	450052
Junta Tapa Trasera Caja de Velocidad	1	CB	450053

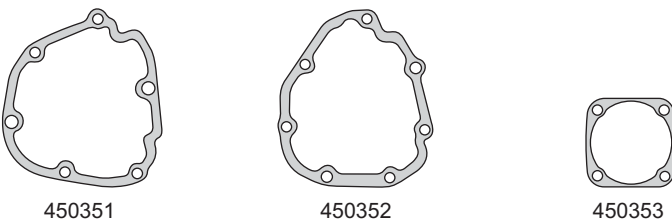

450350

Caja BA7 - 4 Velocidades

Peugeot - 404/504 1971/...

Descripción	Cant.	Mat.	Código
Junta Caja de Velocidad	1	CB	450351
Junta Caja de Velocidad	1	CB	450352
Junta Caja de Velocidad	1	CB	450353

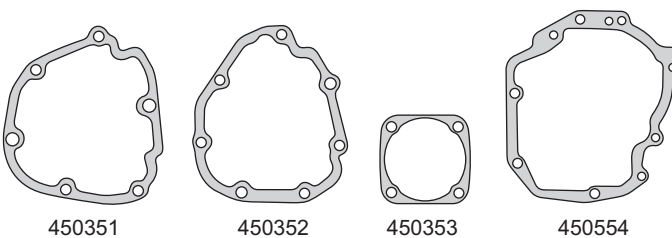

450550

Caja BA7/5 - 5 Velocidades

Peugeot - 504/505 Nafta/Diesel 1983/...

Descripción	Cant.	Mat.	Código
Junta Caja de Velocidad	1	NB	450351
Junta Caja de Velocidad	1	CB	450352
Junta Caja de Velocidad	1	CB	450353
Junta Caja de Velocidad	1	NB	450554

JUEGOS DE JUNTAS PARA CAJAS DE VELOCIDAD

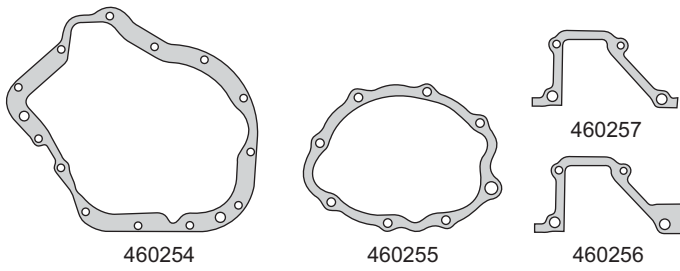

Caja BE3/5 - 5 Velocidades			
460250			
Peugeot 205/306/405 - Nafta/Diesel 1991/...			
Descripción	Cant.	Mat.	Código
Junta Frente Caja	1	NB	460254
Junta Acople Caja	1	NB	460255
Junta Cierre Lateral Izquierdo	1	NB	460256
Junta Cierre Lateral Derecho	1	NB	460257

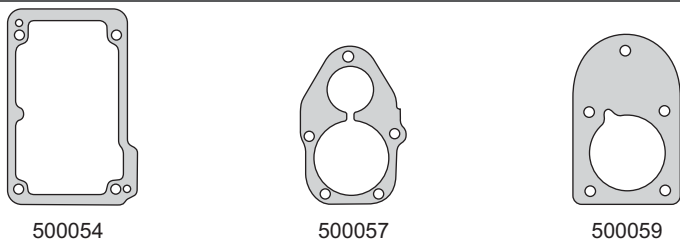

Borgward 42/52HP			
500050			
Rastrojero Diesel 1957/71			
Descripción	Cant.	Mat.	Código
Junta Caja de Velocidad	1	CB	500054
Junta Caja de Velocidad	1	CB	500057
Junta Directa Capavel	1	CB	500059

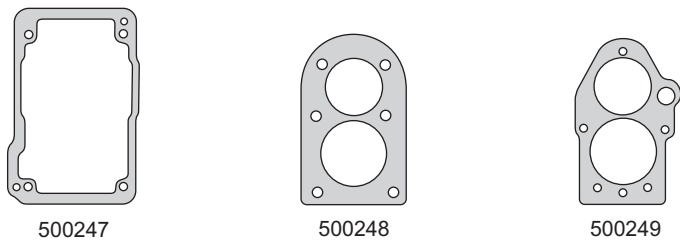

Indenor - XDP 4.88			
500250			
Rastrojero Diesel - Motor Indenor - 4 Cilindros			
Descripción	Cant.	Mat.	Código
Junta Tapa Caja de Velocidad	1	CB	500247
Junta Directa Caja de Velocidad	1	CB	500248
Junta Tapa Trasera Caja de Velocidad	1	CB	500249

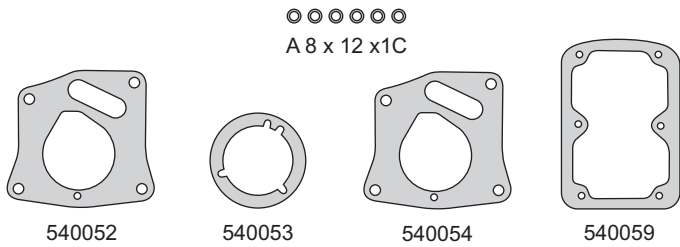

Tracción Simple 4 cil. 4L151 - 6 cil. 6L226			
540050			
Ika - Jeep - Bergantin - Estanciera - Gladiador T80 1954/67			
Descripción	Cant.	Mat.	Código
Junta Acople Trasero Caja	1	CB	540052
Junta Acople Trasero Caja	1	CB	540053
Junta Caja de Velocidad	1	CB	540054
Junta Tapa Caja de Velocidad	1	CG	540059
Arandela A 8 x 12 x 1 C	6	CU	

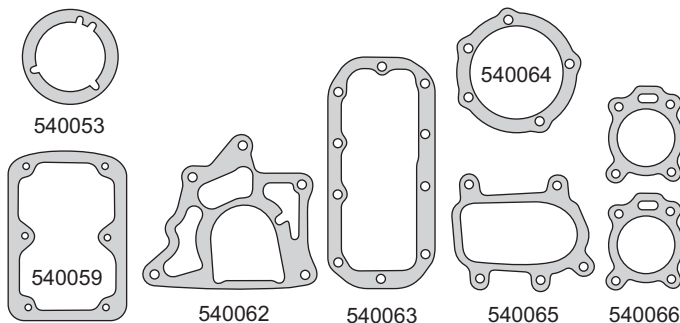

Tracción Doble - 4 cil. 4L151 - 6 cil. 6L226			
540051			
Baqueano 500/1000-Estanciera-Gladiator T80-Jeep-Utilitario			
Descripción	Cant.	Mat.	Código
Junta Acople Trasero Caja	1	NB	540053
Junta Tapa Caja de Velocidad	1	CG	540059
Junta Cártel c/vel. Doble Tracción	1	NB	540063
Jta. Inspección c/vel. Doble Tracción	1	NB	540064
Jta. Fuerza c/vel. Doble Tracción	1	NB	540065
Jta. Acople c/vel. Doble Tracción	2	NB	540066
Jta. Caja Velocidad Doble Tracción	1	NB	540067

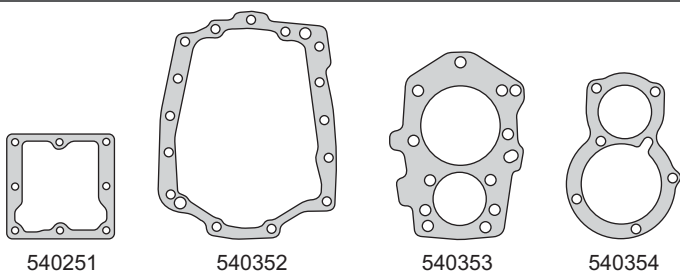

Caja ZF - 4 Velocidades			
540350			
Torino 7B			
Descripción	Cant.	Mat.	Código
Junta Tapa Caja de Velocidad	1	CG	540251
Junta Frente Caja de Velocidad	1	CB	540352
Junta Acople Trasero	1	CB	540353
Junta Acople Delantero	1	CB	540354



JUEGOS DE JUNTAS PARA CAJAS DE VELOCIDAD

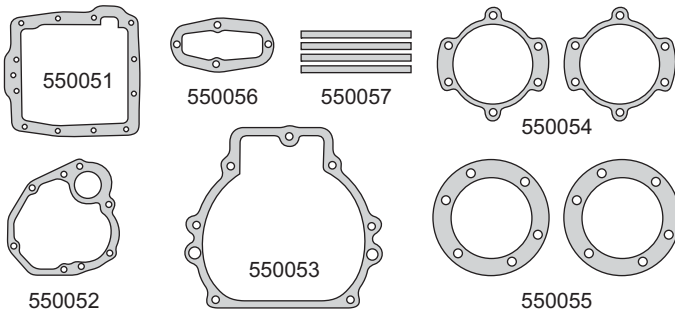

3/4 Velocidades 550050			
Renault Dauphine - Gordini 4L - 4F -S			
Descripción	Cant.	Mat.	Código
Junta Cártter Caja de Velocidad	1	CG	550051
Junta Cola Caja de Velocidad	1	CB	550052
Junta Frente Caja de Velocidad	1	CB	550053
Junta Caja de Velocidad	2	CB	550054
Junta Palier Caja de Velocidad	2	CB	550055
Junta Tapa Inspección Caja Vel.	1	CB	550056
Retén Filtro Palier Caja Velocidad	4	FIE	550057

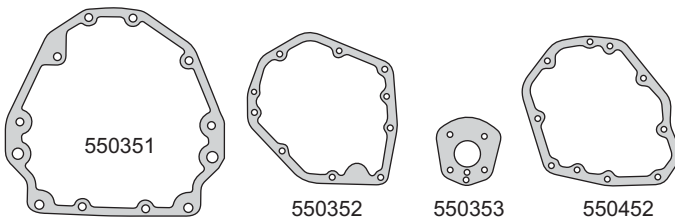

4 Velocidades 550350			
Renault R6 - R12			
Descripción	Cant.	Mat.	Código
Junta Frente Caja de Velocidad	1	CB	550351
Junta Salida de Caja de Velocidad	1	CB	550352
Junta Palanca de Cambio	1	CB	550353
Junta Salida de Caja	1	CB	550452

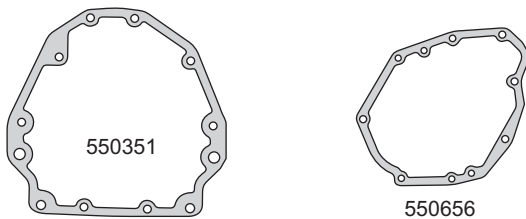

Caja de 5ta. 550450			
Renault 12			
Descripción	Cant.	Mat.	Código
Junta Frente Caja de Velocidad	1	CB	550351
Junta Tapa Trasera Caja de 5ta.	1	CB	550656

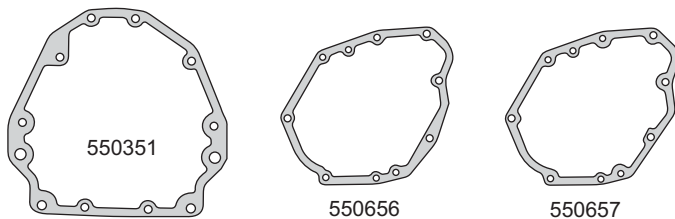

Caja de 5ta. 550650			
Renault 18			
Descripción	Cant.	Mat.	Código
Junta Frente Caja de Velocidad	1	CB	550351
Junta Tapa Trasera Caja de 5ta.	1	CB	550656
Junta Tapa Trasera Caja de 5ta.	1	CB	550657

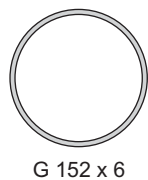

550750			
Renault R9/11/12/18/19 - Express - Clio - Kangoo Nafta/Diesel			
Descripción	Cant.	Mat.	Código
O'ring G 152 x 6	1	GS	550751

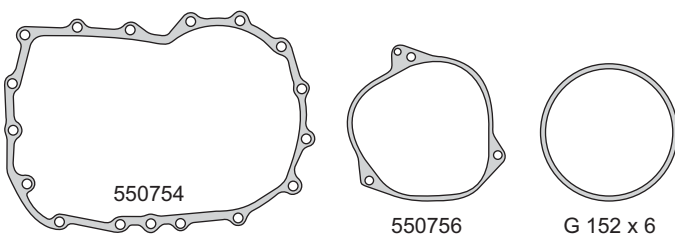

550752			
Renault R9/11/12/18/19 - Express - Clio - Kangoo Nafta/Diesel			
Descripción	Cant.	Mat.	Código
Junta Frente Caja Cierre	1	CB	550754
Junta Trasera Caja de Velocidad	1	CB	550756
O'ring G 152 x 6	1	GS	550751

JUEGOS DE JUNTAS PARA CAJAS DE VELOCIDAD

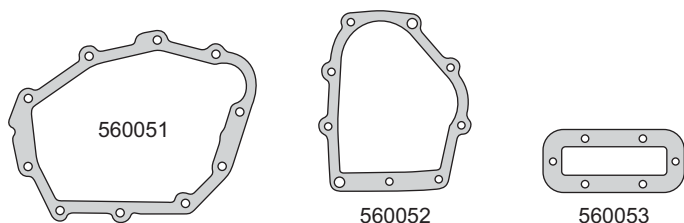

560050

Renault Traffic Diesel

Descripción	Cant.	Mat.	Código
Junta Caja de Velocidad	1	NB	560051
Junta Caja de Velocidad	1	CB	560052
Junta Caja de Velocidad	1	NB	560053

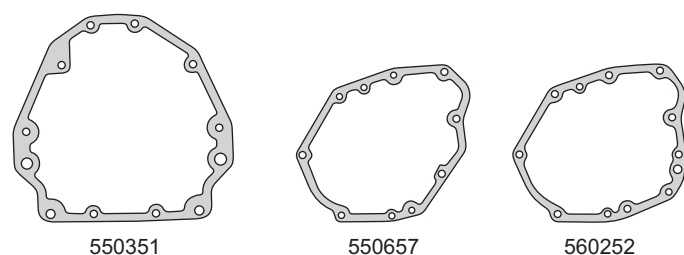

560250

Dacia 1310 - 1410 TXL 1992/...

Descripción	Cant.	Mat.	Código
Junta Frente Caja de Velocidad	1	CB	550351
Junta Tapa Trasera Caja de 5ta.	1	CB	550657
Junta Caja de Velocidad	1	CB	560252

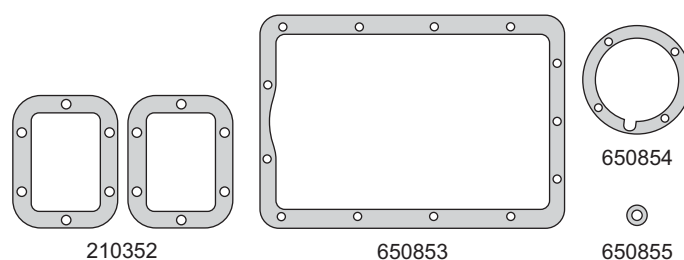

650850

Caja Clark S5/405

Deutz - 6 cil. Omnibus OA 101 - Eaton Man Modelo 405 - 413N

Descripción	Cant.	Mat.	Código
Junta Caja de Velocidad	2	CB	210352
Junta Caja de Velocidad	1	ST	650853
Junta Caja de Velocidad	1	ST	650854
Junta Caja de Velocidad	1	CB	650855

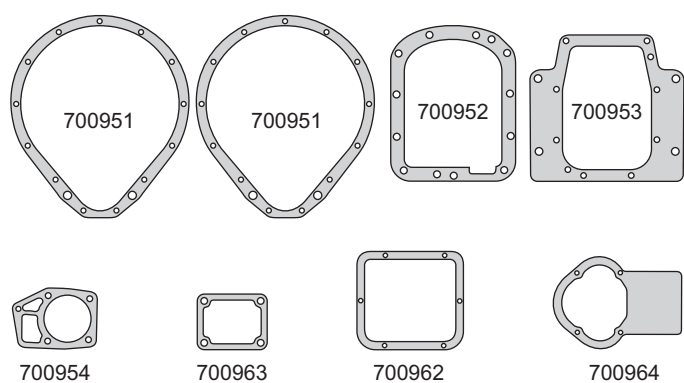

700950

Fiat 411 R - Tractor

Descripción	Cant.	Mat.	Código
Junta Caja de Velocidad	2	CB	700951
Junta Intermedia Caja de Vel.	1	NB	700952
Junta Caja de Velocidad	1	CB	700953
Junta Caja de Velocidad	1	CB	700954
Junta Tapa Caja de Velocidad	1	NB	700962
Junta Tapa Posterior Chica	1	CB	700963
Junta Tapa Superior Diferencial	1	NB	700964

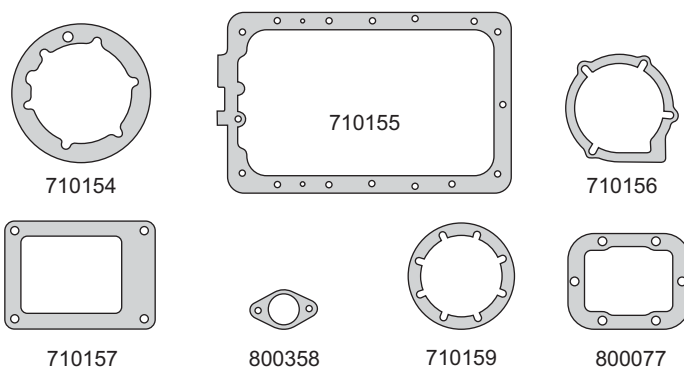

710150

Fiat 673 - Dodge DD1000

Descripción	Cant.	Mat.	Código
Junta Caja de Velocidad	1	NB	710154
Junta Caja de Velocidad	1	NB	710155
Junta Contra Eje Acople	1	NB	710156
Junta Tapa Palanca	1	NB	710157
Junta Directa	1	CG	710159
Junta Toma Fuerza	1	NH	800077
Junta Velocímetro	1	NH	800358



JUEGOS DE JUNTAS PARA CAJAS DE VELOCIDAD

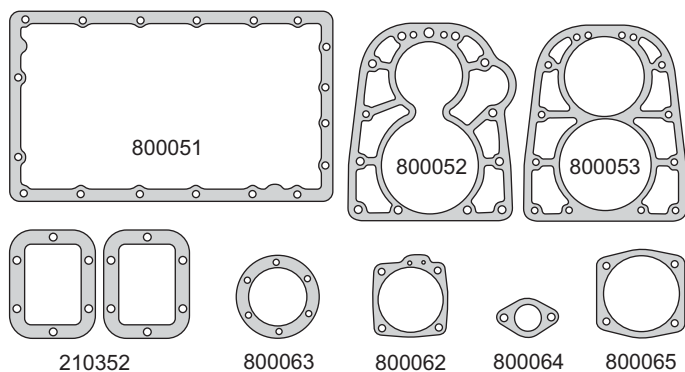

Caja T90

800050

Fiat 619 N1

Descripción	Cant.	Mat.	Código
Junta Caja de Velocidad	2	CB	210352
Junta Caja de Velocidad	1	NB	800052
Junta Caja de Velocidad	1	NB	800053
Junta Palanca	1	NB	800059
Junta Caja de Velocidad	1	NB	800062
Junta Caja de Velocidad	1	NB	800063
Junta Caja de Velocidad	1	NB	800064
Junta Contraeje Caja	1	NB	800065

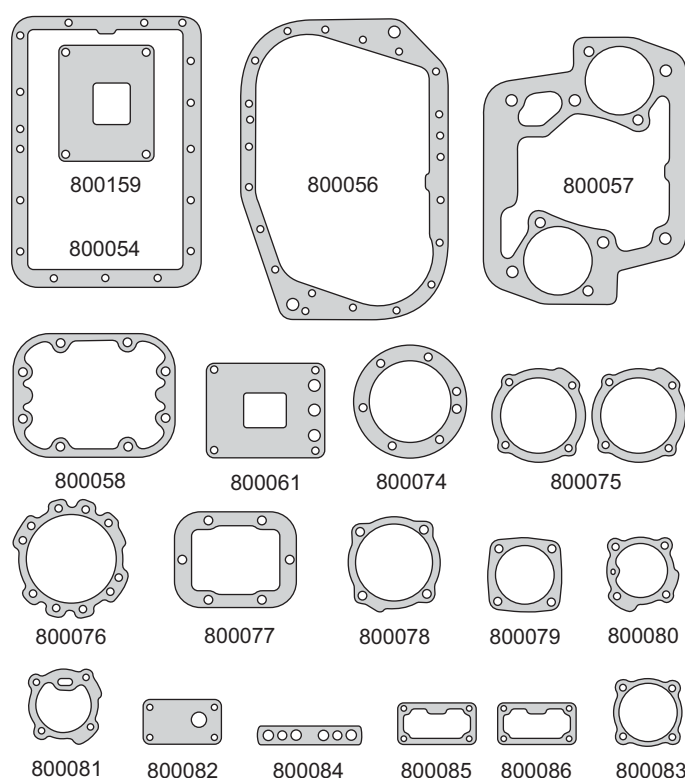

Caja Fuller K2199

800051

Fiat 619 N1

Descripción	Cant.	Mat.	Código
Junta Caja de Velocidad	1	NB	800054
Junta Frente Caja Fuller	1	NB	800056
Junta Tapa Trasera Caja Fuller	1	NB	800057
Junta Palanca	1	NB	800058
Junta Palanca	1	NB	800159
Junta Tapa Válvulas	1	NB	800061
Junta Directa	1	NB	800074
Junta Regulador	2	NB	800075
Junta Base Directa	1	CB	800076
Junta Inspección Toma Fuerza	1	NB	800077
Junta Regulador	1	NB	800078
Junta Contra Eje	1	NB	800079
Junta Eje	1	NB	800080
Junta Eje	1	NB	800081
Junta Válvula	1	NB	800082
Junta Contra Eje	1	NB	800083
Junta Varilla	1	NB	800084
Junta Válvula	1	NB	800085
Junta Válvula	1	NB	800086

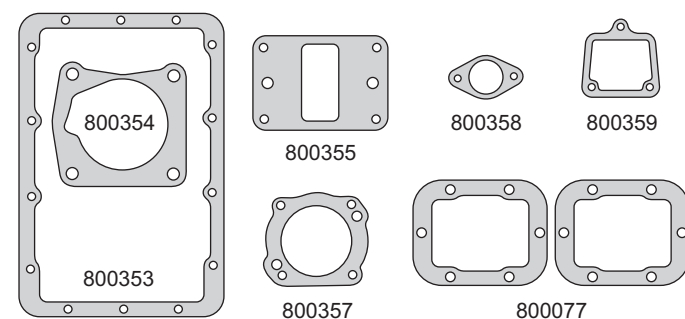

Caja Eaton FS 5005 - FS 5205

800350

Fiat Camión 150 Turbo

Descripción	Cant.	Mat.	Código
Junta Inspección Toma Fuerza	2	NB	800077
Junta Tapa Caja de Velocidad	1	NB	800353
Junta Caja de Velocidad	1	CB	800354
Junta Directa Fiat	1	NB	800355
Junta Contra Eje	1	NB	800357
Junta Junta Velocímetro	1	NB	800358
Junta Control Remoto	1	CG	800359

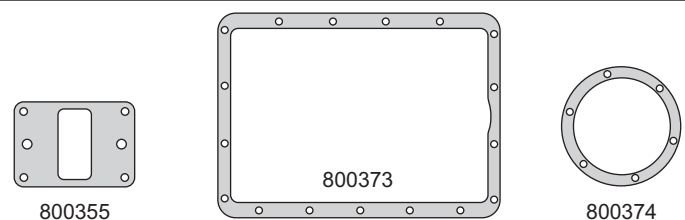

Caja FAE 475/GRS

800351

Iveco Eurocargo 135/150/170 E23 - G205

Descripción	Cant.	Mat.	Código
Junta Palanca Cambio	1	NH	800355
Junta Tapa Caja de Velocidad	1	NH	800373
Junta Directa Caja de Velocidad	1	NH	800374

JUEGOS DE JUNTAS PARA CAJAS DE VELOCIDAD

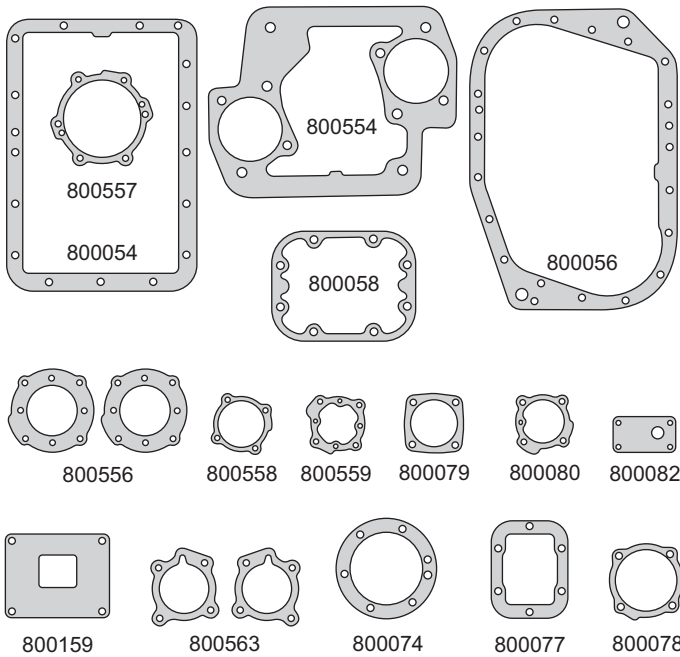

Original 7149553		800550	
Iveco Eurotracker - 240/260 Motor 8010-42			
Descripción	Cant.	Mat.	Código
Junta Caja de Velocidad	1	NB	800054
Junta Frente Caja Fuller	1	NB	800056
Junta Palanca	1	NB	800058
Junta Directa	1	NB	800074
Junta Toma Fuerza	1	NB	800077
Junta Regulador	1	NB	800078
Junta Contra Eje	1	NB	800079
Junta Eje	1	NB	800080
Junta Válvula	1	NB	800082
Junta Palanca Cambios	1	NB	800159
Junta Trasera Caja	1	NB	800554
Junta Acople Caja	2	NB	800556
Junta Base Directa	1	CB	800557
Junta Caja de Velocidad	1	NB	800558
Junta Caja de Velocidad	1	NB	800559
Junta Caja de Velocidad	2	NB	800563

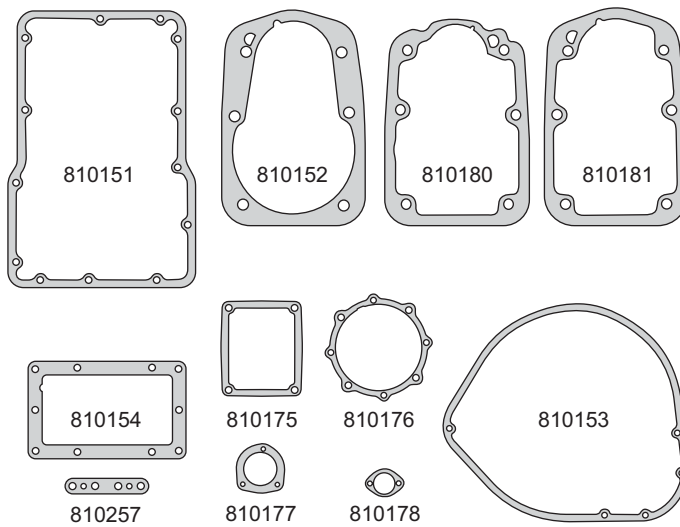

GRS 870/871 - 10 Velocidades		810150	
Scania L111/112			
Descripción	Cant.	Mat.	Código
Junta Caja de Velocidad	1	NB	810151
Junta Caja de Velocidad	1	NB	810152
Junta Caja de Velocidad	1	NB	810153
Junta Caja de Velocidad	1	CG	810154
Junta Caja de Velocidad	1	NB	810175
Junta Caja de Velocidad	2	NB	810176
Junta Caja de Velocidad	1	NB	810177
Junta Velocímetro	2	NB	810178
Junta Caja de Velocidad	1	NB	810179
Junta Acople Caja de Velocidad	1	NB	810180
Junta Acople Caja de Velocidad	1	NB	810181
Junta Varilla Caja de Velocidad	1	NB	810257

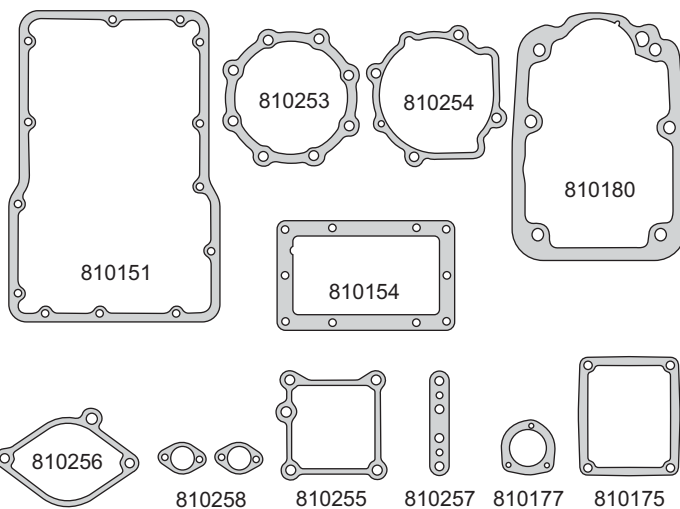

GRS 776 - 5 Velocidades		810250	
Scania - K112 - Bus			
Descripción	Cant.	Mat.	Código
Junta Caja de Velocidad	1	NH	810151
Junta Caja de Velocidad	1	CG	810154
Junta Suplemento Camisa	1	NH	810175
Junta Suplemento Camisa	1	NH	810177
Junta Acople Caja de Velocidad	1	NH	810180
Junta Caja de Velocidad	1	NH	810253
Junta Caja de Velocidad	1	NH	810254
Junta Caja de Velocidad	1	NH	810255
Junta Base Palanca	1	NH	810256
Junta Varilla	1	NH	810257
Junta Velocímetro	2	NH	810258



JUEGOS DE JUNTAS PARA CAJAS DE VELOCIDAD

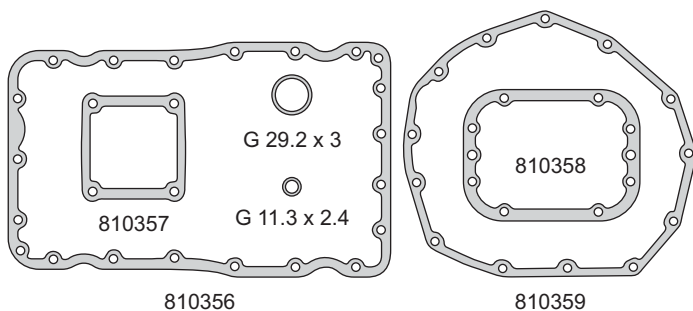

GRS 900 - 12 Velocidades

810350

Scania Camión 113/114/124

Descripción	Cant.	Mat.	Código
Junta Caja de Velocidad	1	NH	810356
Junta Caja de Velocidad	1	NH	810357
Junta Caja de Velocidad	1	NH	810358
Junta Caja de Velocidad	1	NH	810359
O´ring G11.3 x 2.4	1	GS	
O´ring G 29.2 x 3	1	GS	

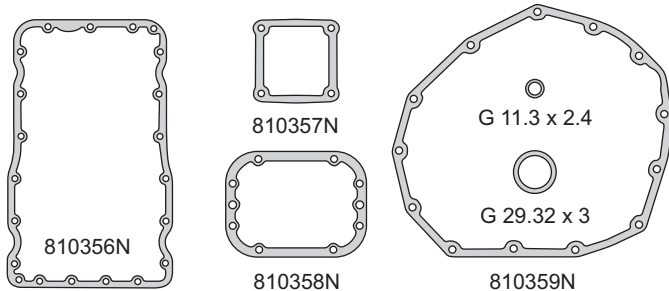

GRS 900 - 12 Velocidades

810351

Scania Camión 113/114/124

Descripción	Cant.	Mat.	Código
Junta Caja de Velocidad	1	NB	810356N
Junta Caja de Velocidad	1	NB	810357N
Junta Caja de Velocidad	1	NB	810358N
Junta Caja de Velocidad	1	NB	810359N
O´ring G11.3 x 2.4	1	GS	
O´ring G 29.2 x 3	1	GS	

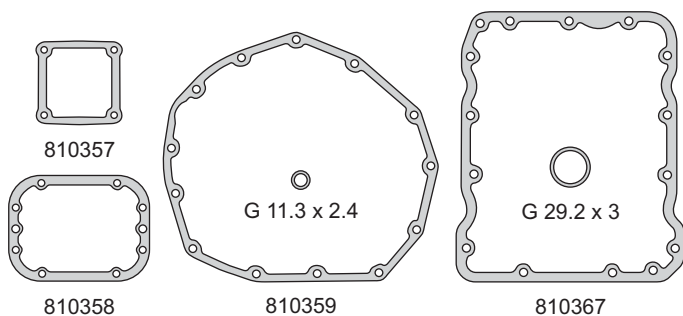

GR 801 - 8 Velocidades

810352

Scania Camión P93 - P94 Bus K113

Descripción	Cant.	Mat.	Código
Junta Caja de Velocidad	1	NH	810357
Junta Caja de Velocidad	1	NH	810358
Junta Caja de Velocidad	1	NH	810359
Junta Entrada Turbo	1	NH	810367
O´ring G 11.3 x 2.4	1	GS	
O´ring G 29.2 x 3	1	GS	

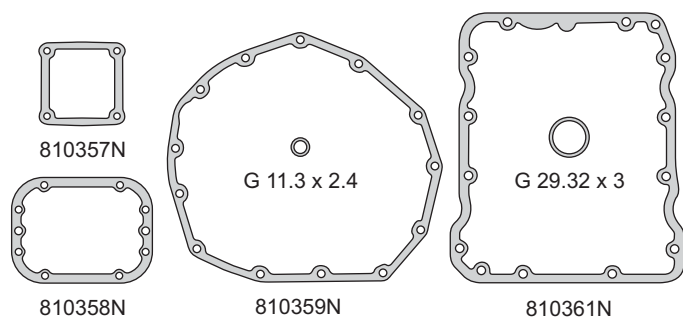

GR 801 - 8 Velocidades

810353

Scania Camión P93 - P94 - Bus K113

Descripción	Cant.	Mat.	Código
Junta Caja de Velocidad	1	NB	810357N
Junta Caja de Velocidad	1	NB	810358N
Junta Caja de Velocidad	1	NB	810359N
Junta Entrada Turbo	1	NB	810361N
O´ring G 11.3 x 2.4		GS	
O´ring G 29.2 x 3		GS	

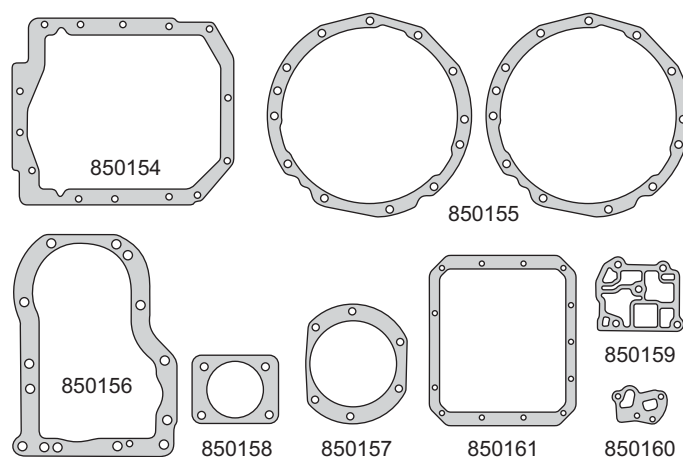

850150

John Deere

Tractor - Equipos Viales - Moto Niveladora - Todos 1420/2320/2420/2530/3530/4420/4530/750A/320/570

Descripción	Cant.	Mat.	Código
Junta Tapa Transmisión Hidráulica	1	NH	850154
Junta Caja Comando Final	2	NH	850155
Junta Unión Caja Transmisión	1	NH	850156
Junta Caja de Velocidad	1	NH	850157
Junta Caja de Velocidad	1	NH	850158
Junta Caja Válvula Alivio	1	NH	850159
Junta Bomba Transmisora	1	NH	850160
Junta Tapa Caja Transmisión	1	CG	850161

JUEGOS DE JUNTAS PARA CAJAS DE VELOCIDAD

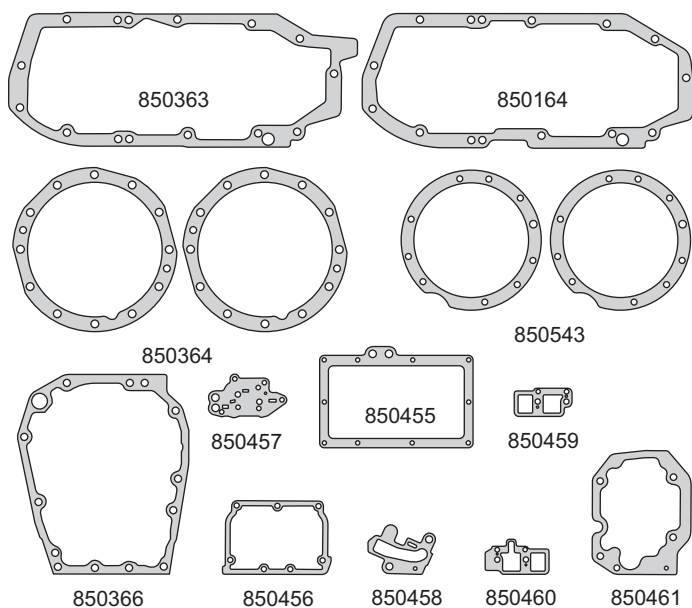

2ª Serie - 4 Velocidades 1985/...

850450

John Deere Tractores
3350/3140/3550 2000/...

Descripción	Cant.	Mat.	Código
Junta Tapa Caja de Velocidad	1	NH	850164
Junta Tapa Caja de Velocidad	1	NH	850363
Junta Manga Diferencial	2	NH	850364
Junta Frente	1	NH	850366
Junta Tapa - L61966	1	NH	850455
Junta Tapa - L34345	1	NH	850456
Junta Acople - L61964	2	NH	850457
Junta Acople - L63387	2	NH	850458
Junta Hidráulica - L34544	1	NH	850459
Junta Hidráulica - L 33342	1	NH	850460
Junta	1	NH	850461
Junta Manga Diferencial	2	SLS	850543

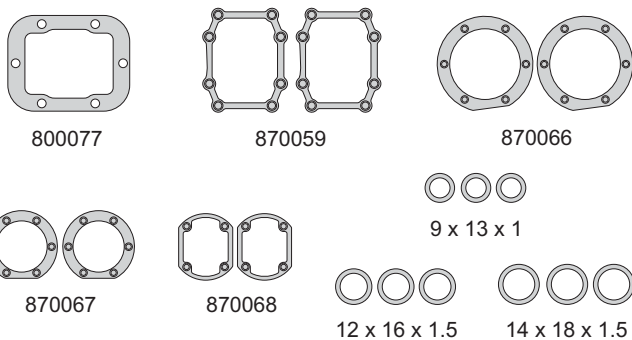

Caja ZF S5-420 5 Velocidades

870050

Ford F100/4000

Descripción	Cant.	Mat.	Código
Junta Caja de Velocidad	1	NB	800077
Junta Toma Torreta	1	NB	870059
Junta Directa	1	NB	870066
Junta Contra Eje	1	NB	870067
Junta Inspección	1	NB	870068
A12x16x1.5 C	3	CU	
A14x18x1.5 A	1		
A9x13x1 A	2		

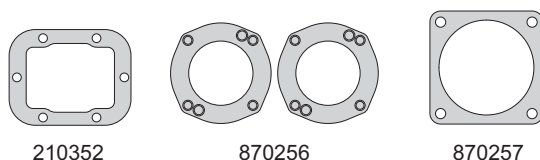

Eaton FS-6306 A 6 Velocidades 1996

870250

Ford Cargo - 1722

Descripción	Cant.	Mat.	Código
Junta Caja de Velocidad	2	CB	210352
Junta Caja de Velocidad	1	NH	800351
Junta Acople	1	NB	870256
Junta Acople	1	HL	870257

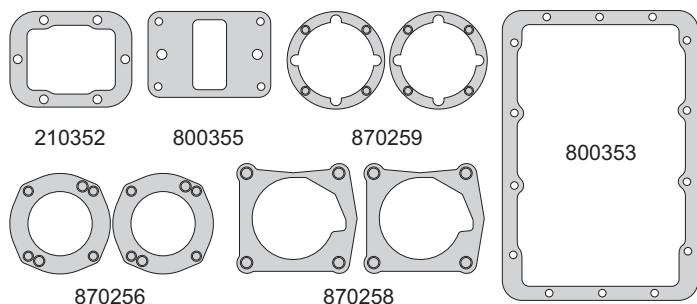

Caja Eaton FS -5205 A 5 Velocidades

870251

Ford Cummins

Descripción	Cant.	Mat.	Código
Junta Caja de Velocidad	2	CB	210352
Junta Caja de Velocidad	1	NB	800353
Junta	1	NB	800355
Junta Acople	1	NB	870256
Junta Acople	1	NB	870258
Junta Acople	1	HL	870259

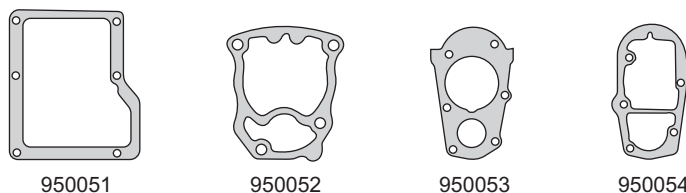

AB 20/30 547cc.

950050

Daihatsu - Max Cuore - Wide Cab - Cab Van 1980/...

Descripción	Cant.	Mat.	Código
Junta Caja de Velocidad	1	CB	950051
Junta Caja de Velocidad	1	CB	850052
Junta Caja de Velocidad	1	CB	950053
Junta Caja de Velocidad	1	CB	950054



JUEGOS DE JUNTAS PARA CAJAS DE VELOCIDAD

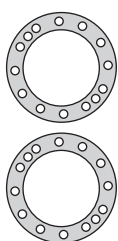

300557

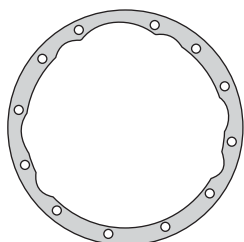

350368

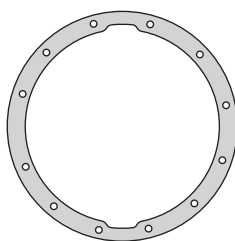

350369

Diferencial Eaton 161/162
Grande A y B

210155

Bedford - Chevrolet 350 - Ford 700/600/700
Dodge DP600/800 - MB 911/1112/1114

Descripción	Cant.	Mat.	Código
Junta Palier	2	NB	300557
Núcleo Diferencial Eaton	1	NB	350368
Junta Tapa Diferencial Eaton	1	CG	350369

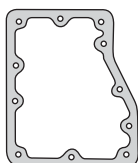

210167

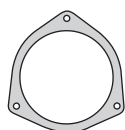

210168



210169

Motor Eléctrico
Cambios Eaton 132/161/162

210166

Bedford - Chevrolet - Dodge - Ford - Mercedes Benz

Descripción	Cant.	Mat.	Código
Junta Tapa Motor Eléctrico	1	CG	210167
Junta Acople Motor Eléctrico	1	CG	210168
Junta Tapa Inferior Motor Eléctrico	1	NH	210169



300256

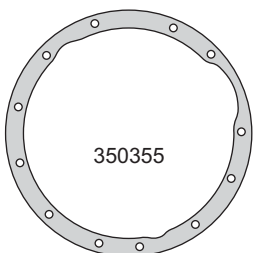

350355

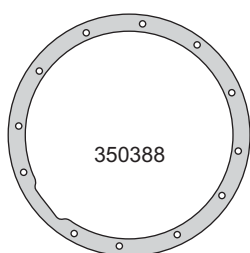

350388

Diferencial Eaton 132 - Chico A y B

300255

Chevrolet C50 - Dodge D400/500 - Ford F600/900 - MB911/4500

Descripción	Cant.	Mat.	Código
Junta Palier	2	CB	300256
Junta Núcleo Diferencial Eaton	1	CB	350355
Junta Tapa Diferencial Eaton	1	CG	350388

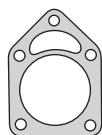

450056

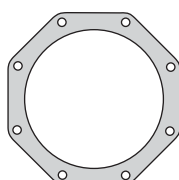

450059

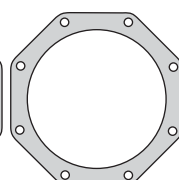

450062

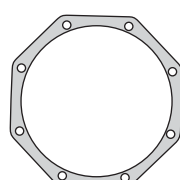

450055

Peugeot 404 1962/67

Descripción	Cant.	Mat.	Código
Junta Tubo de Empuje	1	CB	450056
Junta Cierre Diferencial Ancha	2	NB	450059
Junta Cierre Diferencial Angosta	1	CB	450062

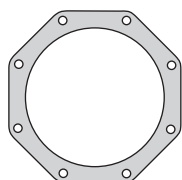

450059

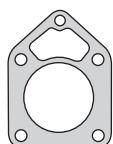

450156

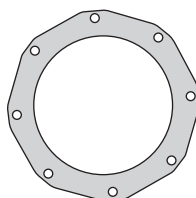

450159

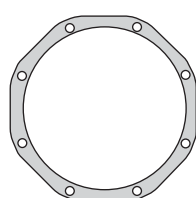

450162

450155

Peugeot 404 - 504 1969/80

Descripción	Cant.	Mat.	Código
Junta Cierre Diferencial Ancha	1	NB	450059
Junta Tubo de Empuje	1	CB	450156
Junta Cierre Manga Ancha	1	CB	450159
Junta Cierre Diferencial Angosta	1	CB	450162

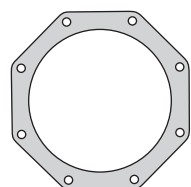

450059

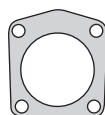
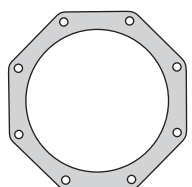

450556

450555

Peugeot 505

Descripción	Cant.	Mat.	Código
Junta Cierre Diferencial Ancha	2	NB	450059
Tubo Empuje	1	CB	450556

JUNTAS PARA PALIER

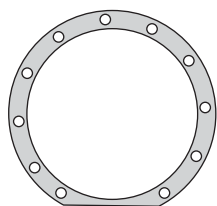

140056	
DKW 1000 - 1000S	
Descripción	Mat.
Junta Tapa Diferencial	CB

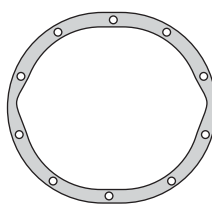

EATON Nacional Autoblocante 200059	
Chevrolet Super - Special - Chevy C10 - 1020 - D10 BR Ford Pick Up - F100 1992 - Dodge 100/200	
Descripción	Mat.
Junta Tapa Diferencial	CG

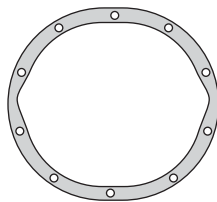

EATON Nacional Autoblocante 200067	
Chevrolet Super - Special - Chevy C10 - D10 - D20 BR Ford Pick Up - F100 1992 - Dodge 100/200	
Descripción	Mat.
Junta Tapa Diferencial	CGT

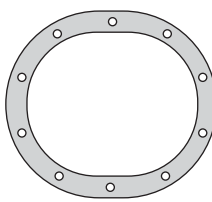

200069	
Chevrolet Impala	
Descripción	Mat.
Junta Tapa Diferencial	NFT

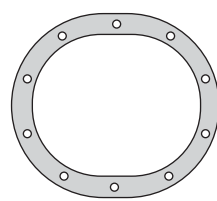

200434	
Chevrolet Impala	
Descripción	Mat.
Junta Tapa Diferencial	NH

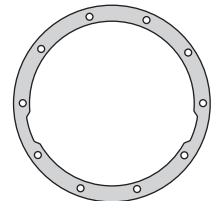

Diferencial Mowog 210959	
Di Tella 1500 Argenta	
Descripción	Mat.
Junta e/carcaza y porta Diferencial	CG

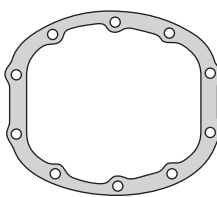

EATON 12/32 Brasilero 220159	
Dodge 1500	
Descripción	Mat.
Junta Tapa Diferencial	CB

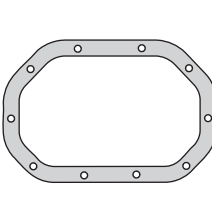

240059	
Chevrolet - Opel Monza 1.6/1.8/2.0	
Descripción	Mat.
Junta Cáster Diferencial	NH

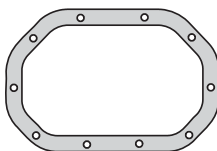

240059/1	
Chevrolet - Opel Monza 1.6/1.8/2.0	
Descripción	Mat.
Junta Cáster Diferencial	CG

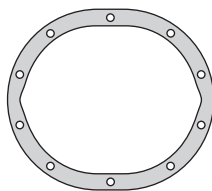

Brasilero 240159	
Chevrolet - Chevette 1.4/1.6 1973/...	
Descripción	Mat.
Junta Diferencial	NH

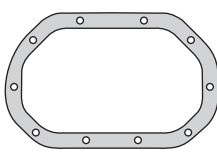

240259	
Chevrolet - Monza 1.6/1.8/2.0 (Todos)	
Descripción	Mat.
Junta Diferencial	NH

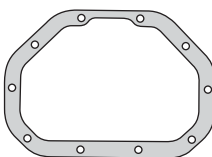

240459	
Chevrolet Astra - Corsa 1.0/1.4/1.6	
Descripción	Mat.
Junta Cáster Diferencial	CB

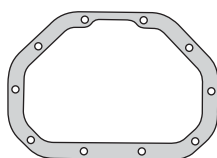

240459/1	
Chevrolet Astra - Corsa 1.0/1.4/1.6	
Descripción	Mat.
Junta Cáster Diferencial	CG

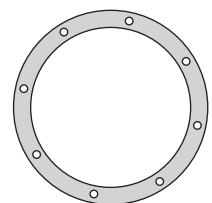

250059	
Fiat 1100 - Lada 1600	
Descripción	Mat.
Junta e/carcaza y porta Diferencial	CB

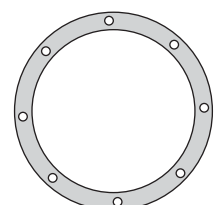

EATON Nacional Autoblocante 250259	
Fiat 125 - 1500 - 1600	
Descripción	Mat.
Junta e/carcaza y porta Diferencial	CB

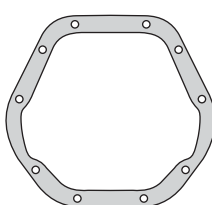

Dana 44 300086	
Ford F100 - Falcon - Fairlane - Ika Chevrolet Pick Up 1996/... C14 1967/70	
Descripción	Mat.
Junta Tapa Diferencial	NH



JUNTAS PARA DIFERENCIAL

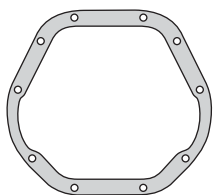

Brasilero - Salisbury **300087**

Ford F75 - F100 - F1000 - F2000 - Willys
Chevrolet C14 1967/70

Descripción	Mat.
Junta Diferencial	NH

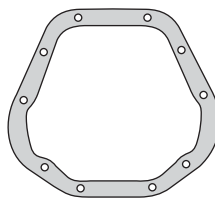

Spicer 60/70 - Dana **300264**

Ford F250 - F350

Descripción	Mat.
Junta Tapa Diferencial	CG

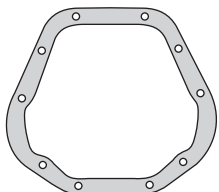

Spicer 70 - Dana **300265**

Ford F250 - F350

Descripción	Mat.
Junta Tapa Diferencial	NH

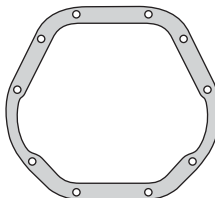

Brasilero **300272**

Ford F2000 - F4000 1982/...

Descripción	Mat.
Junta Diferencial	NH

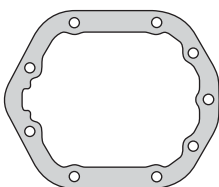

300659

Ford Sierra 1.6

Descripción	Mat.
Junta Tapa Diferencial	NH

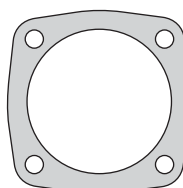

300835

Ford A - AA

Descripción	Mat.
Porta Piñón Diferencial	NH

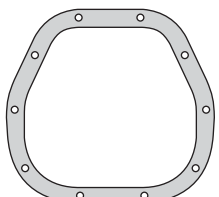

Dana 46 **310459**

Ford F100 - F1000 - MWM 2294cc.
Chevrolet C20 - D20 1994/97 - Silverado
Blazer 1995/97

Descripción	Mat.
Junta Tapa Diferencial	NH

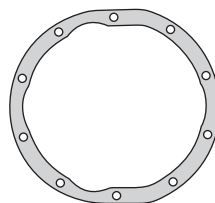

Rockwell **320159**

Ford F100 - Pick Up - Ranger

Descripción	Mat.
Junta Tapa Diferencial	NH

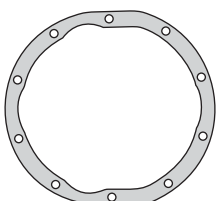

Brasilero **320459**

Ford F4000 1975/81
Fiat Camiones Diesel 1970/80

Descripción	Mat.
Junta Diferencial	NH

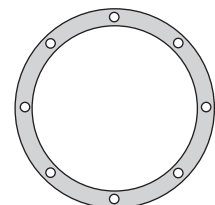

Tipo 34 14" **330359**

Ford Transit D 4EB

Descripción	Mat.
Junta Tapa Diferencial	NH

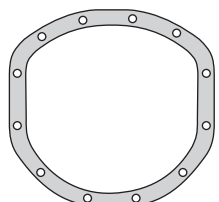

Tipo 51 15" **330361**

Ford Transit D 4EB

Descripción	Mat.
Junta Tapa Diferencial	NH

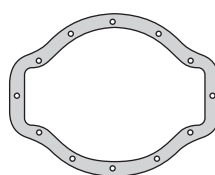

350059

Mercedes Benz 3500 - 4500 OM 311

Descripción	Mat.
Junta Tapa Convensional Simple	CG

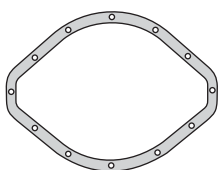

350069

Mercedes Benz 3500-OM 312

Descripción	Mat.
Junta Tapa Diferencial Simple	CG

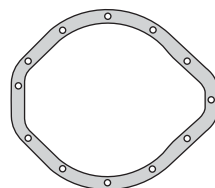

350158

Mercedes Benz OM 314/364 - MB L608D

Descripción	Mat.
Junta Diferencial	NH

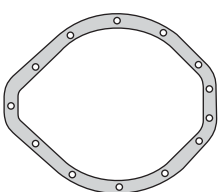

EATON 12/32 Brasilero **350159**

Mercedes Benz L 608D - OM 314/364
D710 D - 817/917/1017

Descripción	Mat.
Junta Tapa Diferencial	CG

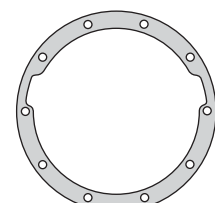

350167

Mercedes Benz - Toyota - Bandeirantes

Descripción	Mat.
Junta Diferencial	NH

JUNTAS PARA PALIER

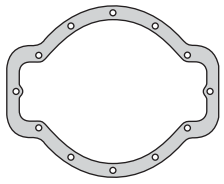

350255	
Mercedes Benz LPO-322/321 - MB1111	
Descripción	Mat.
Junta Diferencial	NH

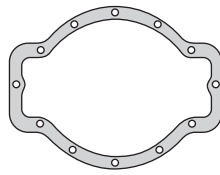

350259	
Mercedes Benz 1112/1114/0140 Bus LP0322/1111/B	
Descripción	Mat.
Junta Tapa Diferencial Simple	CG

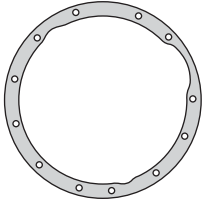

350355	
EATON 132 Alta y Baja (chico)	
Mercedes Benz 911/1112 Ford F350/600	
Descripción	Mat.
Junta Núcleo Diferencial	CB

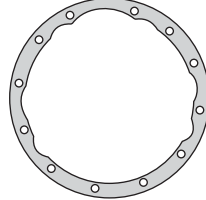

350368	
EATON 132 A y B	
Mercedes Benz 911/1112/1114 Ford F600/6000 - Dodge DP600/800 Chevrolet 350D	
Descripción	Mat.
Junta Núcleo Diferencial	NB

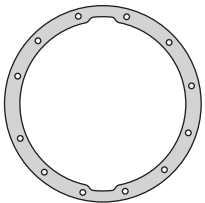

350369	
EATON 161/162	
Mercedes Benz 911/1112/1114 Ford F600/6000/7000 - Dodge DP600/800 Chevrolet 350D	
Descripción	Mat.
Junta Tapa Diferencial	CG

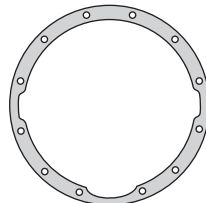

350382	
EATON 162 Alta y Baja	
Mercedes Benz 1114 Dodge D1000 - Ford F600/6000	
Descripción	Mat.
Junta Núcleo Diferencial	CB

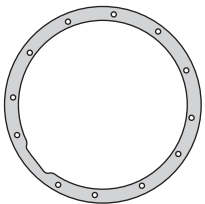

350388	
EATON 132 A y B (chico)	
Mercedes Benz 1112 - Ford F350/600	
Descripción	Mat.
Junta Tapa Diferencial	CG

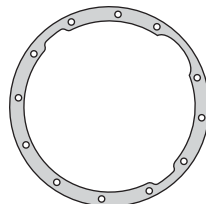

350389	
EATON 161/162	
Mercedes Benz 1114 - Ford F600	
Descripción	Mat.
Junta Tapa Diferencial	CG

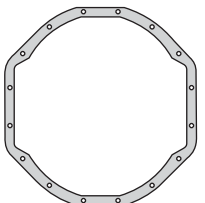

350459	
Mercedes Benz 1517/6600/1215 - OM352A	
Descripción	Mat.
Junta Tapa Diferencial	CG

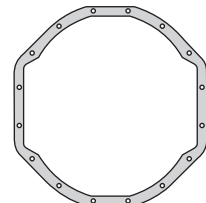

350467	
Mercedes Benz 1517/6600 - OM352A	
Descripción	Mat.
Junta Tapa Diferencial	CB

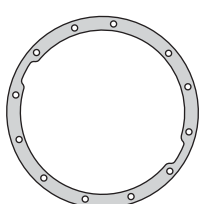

350486	
EATON 161/162	
Mercedes Benz 1114	
Descripción	Mat.
Junta Tapa Diferencial	NH

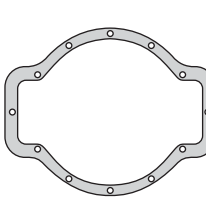

350487	
Mercedes Benz OH1419 - 1314/1318 Bus OM904 - 712/812 - 817/917/1017	
Descripción	Mat.
Junta Tapa Diferencial	NH

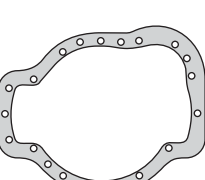

350656	
Mercedes Benz OM2213	
Descripción	Mat.
Junta Diferencial	NH

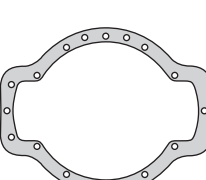

350658	
Mercedes Benz MB1924	
Descripción	Mat.
Junta Diferencial	NH

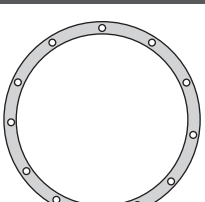

360156	
Mercedes Benz 180D - OM616	
Descripción	Mat.
Junta Frente Caja	NH

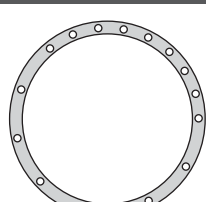

400759	
Massey Ferguson 165/265	
Descripción	Mat.
Junta Unión Manga Diferencial	CB



JUNTAS PARA DIFERENCIAL

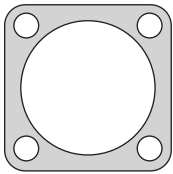

450054

Peugeot 403 - 404 1962/80

Descripción	Mat.
-------------	------

Jta. Tapa Trasera sin Fin Diferencial	CB
---------------------------------------	----

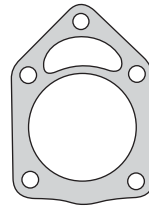

450056

Peugeot 403 - 404 - 504 1962/67

Descripción	Mat.
-------------	------

Junta Tubo Empuje Diferencial	CB
-------------------------------	----

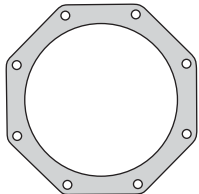

450059

Peugeot 403 - 404 - 504 1962/67

Descripción	Mat.
-------------	------

Junta Cierre Manga Diferencial	NB
--------------------------------	----

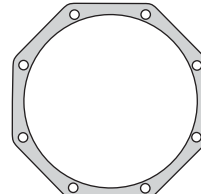

450062

Peugeot 403 - 404 - 504 1962/67

Descripción	Mat.
-------------	------

Jta Cierre Manga Diferencial Angosto	CB
--------------------------------------	----

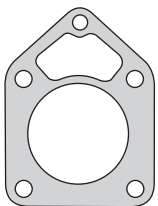

450156

Peugeot 404 - 504 1968/80

Descripción	Mat.
-------------	------

Junta Tubo Empuje Diferencial	CB
-------------------------------	----

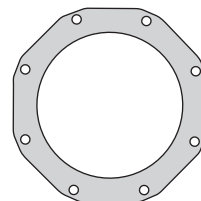

450159

Peugeot 404 - 504 - 505 1967/80

Descripción	Mat.
-------------	------

Jta Cierre Manga Diferencial Ancha	CB
------------------------------------	----

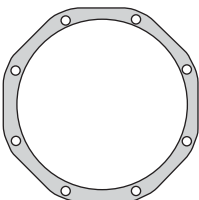

450162

Peugeot 404 - 504 - 505 1967/80

Descripción	Mat.
-------------	------

Jta Cierre Manga Diferencial Angosto	CB
--------------------------------------	----

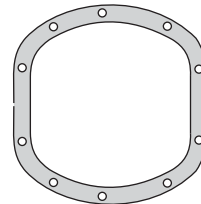

Dana 30 Transax

450355

Peugeot 504 - 505 - Volkswagen 1.5/1.8
Ford Taunus - Falcon 2.3
Chevrolet Pick Up 1970/...

Descripción	Mat.
-------------	------

Junta Tapa Diferencial	CG
------------------------	----

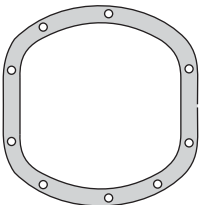

Dana 30 Transax

450362

Peugeot 504 - 505 - Volkswagen 1.5/1.8
Ford Taunus - Falcon 2.3 - Pick Up 1970/...
Chevrolet Pick Up 1970/...

Descripción	Mat.
-------------	------

Junta Tapa Diferencial	CGT
------------------------	-----

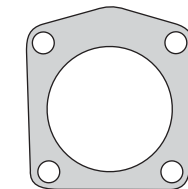

450556

Peugeot 504 - 505

Descripción	Mat.
-------------	------

Junta Tubo Empuje Diferencial	CB
-------------------------------	----

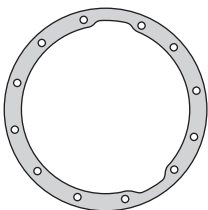

500055

Rastrojero

Descripción	Mat.
-------------	------

Junta Tapa Diferencial	CB
------------------------	----

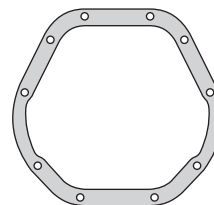

Dana 44

540034

Dodge - Chevrolet - Ford - Ika - Valiant

Descripción	Mat.
-------------	------

Junta Tapa Diferencial	CG
------------------------	----

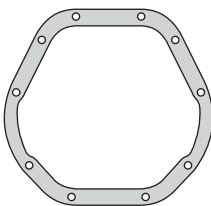

Dana 44

540068

Chevrolet/Dodge/Ford Torino - Ika Todos

Descripción	Mat.
-------------	------

Junta Tapa Diferencial	CGT
------------------------	-----



700951

Fiat Tractor 400/500

Descripción	Mat.
-------------	------

Junta Tapa Reductor Diferencial	CB
---------------------------------	----

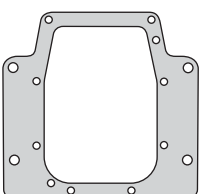

700953

Fiat Tractor 400/500

Descripción	Mat.
-------------	------

Junta Tapa Diferencial	NB
------------------------	----

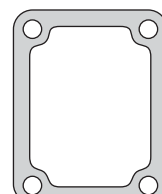

700963

Fiat Tractor 411R

Descripción	Mat.
-------------	------

Jta. Tapa Diferencial Posterior Chica	CB
---------------------------------------	----

JUNTAS PARA PALIER

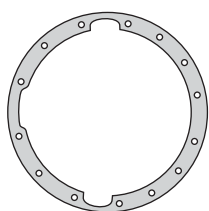

810159	
Scania 111/112	
Descripción	Mat.
Junta Tapa Diferencial	AL

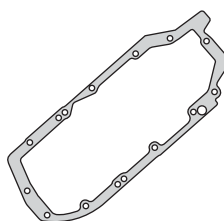

850363	
John Deere 3350/3550/3140	
Descripción	Mat.
Junta Tapa Diferencial	NH

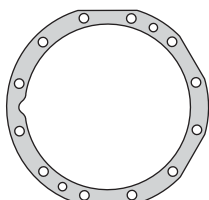

850364	
John Deere 2730	
Descripción	Mat.
Junta Freno Exterior Caja Diferencial	NH

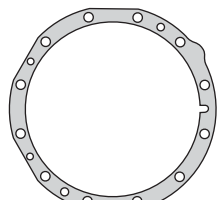

850365	
John Deere 2730	
Descripción	Mat.
Junta Freno Interior Caja Diferencial	NH

JUNTAS PARA PALIER

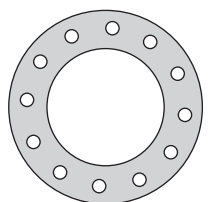

210156	
Chevrolet 350D - Dodge DP600	
Descripción	Mat.
Junta Palier	CB

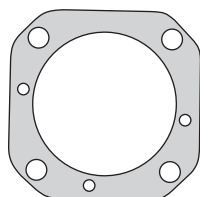

210957	
Dodge 1500 - Siam Argentina	
Descripción	Mat.
Junta Palier	CB

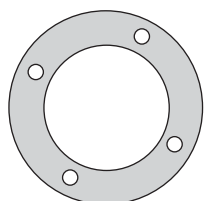

220156	
Dodge 1500/1800 - Brasil	
Descripción	Mat.
Junta Palier	CB

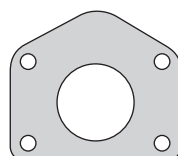

220162	
Dodge 1500/1800 - Nacional	
Descripción	Mat.
Junta Palier	CB

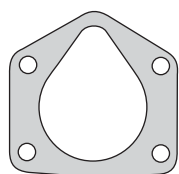

EATON 220164	
Dodge D100	
Descripción	Mat.
Junta Palier	CB

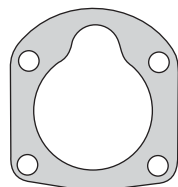

220756	
Dodge D100	
Descripción	Mat.
Junta Palier	CB

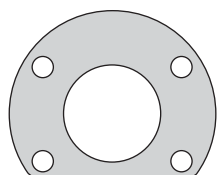

220757	
Dodge D200	
Descripción	Mat.
Junta Palier	NH

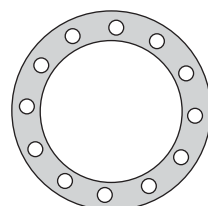

220956	
Dodge DD1000 - Jeep Cherokee	
Descripción	Mat.
Junta Palier	CB

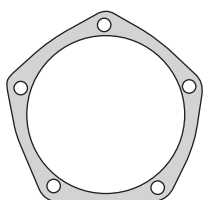

250154	
Fiat 600/750	
Descripción	Mat.
Junta Palier	CB

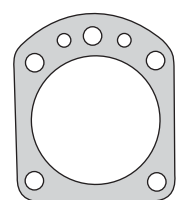

250256	
Fiat 125 1500/1600	
Descripción	Mat.
Junta Palier	CB



JUNTAS PARA PALIER

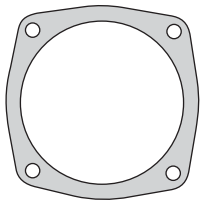

250868	
Fiat 133/600S	
Descripción	Mat.
Junta Palier	CG

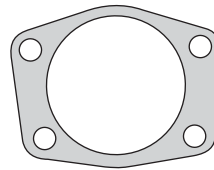

300056	
Ford Falcon 188-221"7B	
Descripción	Mat.
Junta Frenos a Diferencial	CB

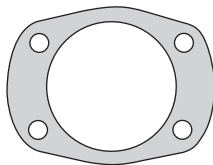

300057	
Ford Falcon	
Descripción	Mat.
Junta Apollo Retén Ruleman	CB

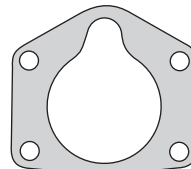

300065	
Dana 44	
Ford Falcon	
Descripción	Mat.
Porta Retén Ruleman Palier	CB

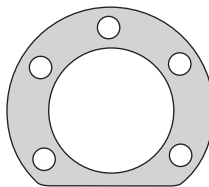

300069	
Ford Falcon F100	
Descripción	Mat.
Junta Palier	CB

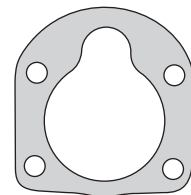

300156	
Dana - Transax	
Ford F100 1970/82	
Descripción	Mat.
Junta Palier	CB

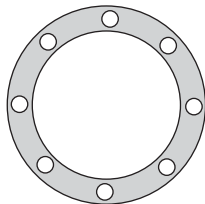

300256	
Chevrolet C50 Dodge D400/500 - Ford F600/900 Mercedes Benz 911/4500	
Descripción	Mat.
Junta Palier	CB

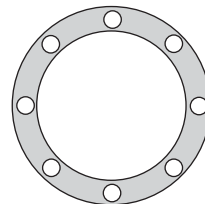

300273	
Tinken	
Ford F600 1957/70 Chevrolet C60 - D60 - D70 - D80	
Descripción	Mat.
Junta Palier	NH

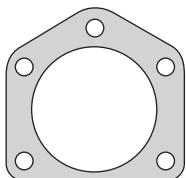

300356	
Ford Taunus 2.0	
Descripción	Mat.
Junta Palier	CB

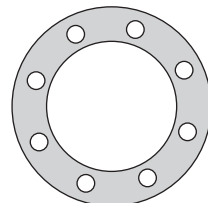

300556	
Dana 60	
Ford F350	
Descripción	Mat.
Junta Palier	CB

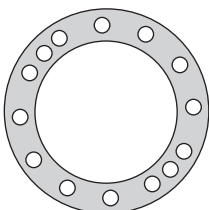

300557	
Bedford Diesel - Chevrolet 350D Dodge DP600/800 - Ford F700/6000 Mercedes Benz 1112/1114	
Descripción	Mat.
Junta Palier	NB

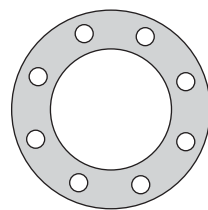

300559	
Dana 60	
Ford F350	
Descripción	Mat.
Junta Palier	AL

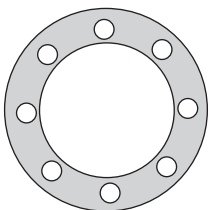

310456	
Ford F4000 F300/350/400 2000/... MWM 2294cc.	
Descripción	Mat.
Junta Palier	CB

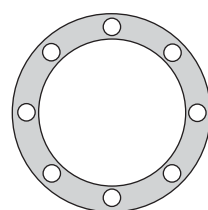

310457	
Ford F600 - F700 - Chevrolet A60	
Descripción	Mat.
Junta Palier	NH

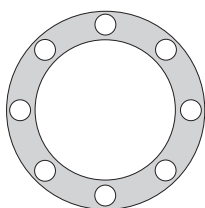

310458	
Ford F300 - F350 - F400 - F2000 Volkswagen 6.80 - 6.90	
Descripción	Mat.
Junta Palier	NH

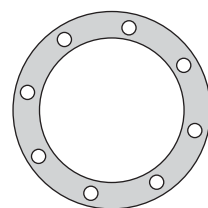

310556	
Ford F14000 - MWM 2296cc. Cargo	
Descripción	Mat.
Junta Palier	CB

JUNTAS PARA PALIER

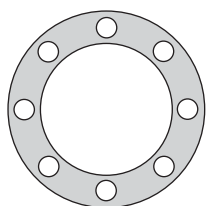

310557	
Ford F700 - F750 - F8000 - F13000	
Descripción	Mat.
Junta Palier	NH

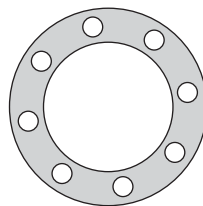

350256	
Mercedes Benz 312/911/3500/608D	
Descripción	Mat.
Junta Palier	AL

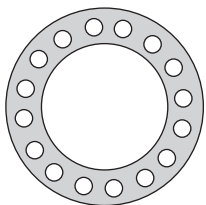

350257	
Alta - Alta y Baja Mercedes Benz 1112/1114	
Descripción	Mat.
Junta Palier	AL

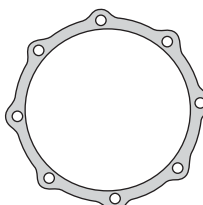

350456	
Mercedes Benz 1517 Turbo OM352A	
Descripción	Mat.
Junta Palier	CB

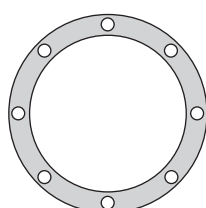

350457	
Mercedes Benz MB1113/1313/1513/2013	
Descripción	Mat.
Junta Palier	MH

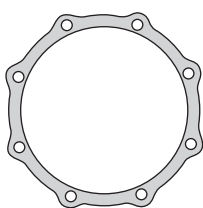

350468	
Mercedes Benz 1517 Turbo OM352A	
Descripción	Mat.
Junta Palier	NH

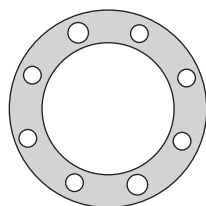

450057	
Peugeot 403/404/504	
Descripción	Mat.
Junta Palier	CB

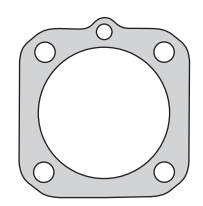

450257	
Peugeot T4B - Pick Up	
Descripción	Mat.
Junta Palier	CB

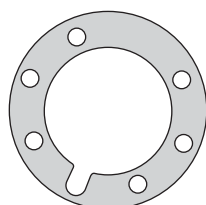

450356	
Transax Peugeot 504 - 505	
Descripción	Mat.
Junta Palier	NH

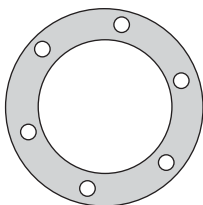

500056	
Rastrojero 42HP	
Descripción	Mat.
Junta Palier	CB

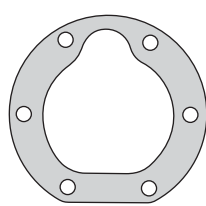

500156	
Transax Rastrojero 52HP	
Descripción	Mat.
Junta Palier	CB

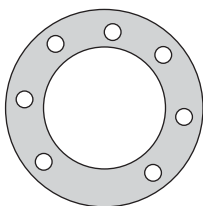

540056	
Jeep Ika - Estanciera - Baqueano	
Descripción	Mat.
Junta Palier	CB

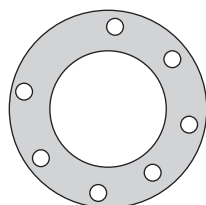

540062	
Jeep Ika - Estanciero - Baqueano - Rambler	
Descripción	Mat.
Junta Palier	CB

Descripción	Mat.